



ibi™ FOCUS®

Creating Reports

Version 9.3.3 | January 2025



Contents

Contents	2
Creating Tabular Reports	68
Requirements for Creating a Report	68
Creating a Report Request	69
Beginning a Report Request	69
Begin a Report Request	69
Issuing Report Requests	70
Reporting With a Default Data Source	71
Requesting Help When Issuing a Report Request	71
Completing a Report Request	72
Selecting a Report Output Destination	72
Developing Your Report Request	73
Developing a Report Request	74
Including Display Fields in a Report Request	76
Referring to Fields in a Report Request	77
Referring to an Individual Field	77
Referring to an Individual Field	78
Referring to Fields Using Qualified Field Names	78
Using a Qualified Field Name to Refer to a Field	78
Referring to All of the Fields in a Segment	79
Referring to All Fields in a Segment	79
Displaying a List of Field Names	80
Listing Field Names, Aliases, and Format Information	80
Displaying Report Data	81
Using Display Commands in a Request	81
Use Display Commands in a Request	81

Displaying Individual Values	82
Displaying Individual Field Values	83
Listing Records	84
Displaying All Fields	85
Displaying All Fields	85
Displaying All Fields in a Segment	87
Display All Fields in a Segment	87
Displaying All Fields in a Segment	87
Displaying the Structure and Retrieval Order of a Multi-Path Data Source	89
Displaying the Retrieval Order of a Multi-Path Data Source	90
Displaying Fields From a Multi-Path Data Source	91
Adding Values	93
Adding Values	93
Adding Non-Numeric Values	94
Counting Values	94
Counting Values	95
Counting Values With a Sort Phrase	95
Counting Instances of Data	96
Counting Segment Instances	96
Counting Segments From a Multi-Path Data Source	97
Expanding Byte Precision for COUNT and LIST	98
Set the Precision for COUNT and LIST	98
Setting Precision for COUNT and LIST	99
Maximum Number of Display Fields Supported in a Request	100
Manipulating Display Fields With Prefix Operators	100
Prefix Operator Basics	101
Use Prefix Operators	102
Usage Notes for Prefix Operators	102
Functions You Can Perform With Prefix Operators	103
Averaging Values of a Field	106
Averaging Values of a Field	106

Averaging the Sum of Squared Fields	106
Averaging the Sum of Squared Fields	107
Calculating Maximum and Minimum Field Values	107
Calculating Maximum and Minimum Field Values	108
Calculating Median and Mode Values for a Field	108
Calculating the Median and Mode	108
Calculating Column and Row Percentages	109
Calculating Column Percentages	109
Calculating Row Percentages	110
Producing a Direct Percent of a Count	111
Producing a Direct Percent of a Count	111
Aggregating and Listing Unique Values	112
Use the Distinct Operator	112
Using the Distinct Operator	113
Counting Distinct Field Values With Multiple Display Commands	114
Distinct Operator Limitations	115
Retrieving First and Last Records	116
Retrieving the First Record	116
Segment Types and Retrieving Records	117
Summing and Counting Values	118
Counting Values With CNT	118
Summing Values With SUM	119
Summing Values With TOT	119
Ranking Sort Field Values With RNK.	120
Calculate Ranks Using the RNK. Prefix Operator	121
Ranking Within Sort Groups	121
Using RNK. in a WHERE TOTAL Test	122
Using RNK. in a COMPUTE Command	123
Rolling Up Calculations on Summary Rows	124
Roll Up Summary Values	125
Rolling Up an Average Calculation	126

Propagating Rollups to Higher Level Sort Breaks	127
Usage Notes for ROLL	129
Calculating the Standard Deviation for a Population or a Sample	130
Calculating the Standard Deviation of a Population	131
Using Report-Level Prefix Operators	131
Calculate Report-Level Average, Maximum, Minimum, and Count Values	132
Using Prefix Operators in a Heading	132
Usage Notes for Report-Level Prefix Operators	134
Viewing and Printing Report Output	135
Displaying Reports in HotScreen	135
Activate HotScreen	135
Using PRINTPLUS	136
Use PRINTPLUS	137
Using PRINTPLUS With SUBFOOT and FOOTING	137
Accessing Help Information	138
Scrolling a Report	138
Scrolling Forward	139
Scrolling Backward	139
Scrolling Horizontally	140
Scrolling From Fixed Columns (Fencing)	141
Scrolling Report Headings	141
Saving Selected Data	142
Locating Character Strings	142
Repeating Commands	143
Redisplaying Reports	143
Previewing Your Report	144
Displaying BY Fields With Panels	145
BYPANEL Conditions	146
Scrolling by Columns of BY Fields	147
The SET COLUMNS Command	147

Displaying Reports in the Panel Facility	148
Printing Reports	149
The OFFLINE Command	149
Printing Reports in HotScreen	150
Displaying Reports in the Terminal Operator Environment	151
Sorting Tabular Reports	152
Sorting Tabular Reports Overview	152
Sorting and Displaying Data	153
Sorting Rows	153
Sort by Rows	153
Usage Notes for Sorting Rows	154
Sorting Rows With BY	155
Using Multiple Vertical (BY) Sort Fields	156
Sorting With Multiple Vertical (BY) Sort Fields	156
Displaying a Row for Data Excluded by a Sort Phrase	157
Display Data Excluded by a Sort Phrase	157
Usage Notes for PLUS OTHERS	158
Displaying a Row Representing Sort Field Values Excluded by a Sort Phrase	159
Displaying a Row Representing Data Not Included in Any Sort Field Grouping	159
Sorting Columns	160
Sort Columns	161
Usage Notes for Sorting Columns	161
Sorting Columns With ACROSS	162
Controlling Display of an ACROSS Title for a Single Field	163
Control Display of an ACROSS Title for a Single Field	163
Displaying or Suppressing a Single ACROSS Column Title	164
Hiding an ACROSS Title With HIDEONE	165
Displaying or Suppressing a Single ACROSS Column Title	166
Hiding an ACROSS Title With ACRSVRBTITL	167
Positioning ACROSS Titles on Report Output	170

Control the Position of ACROSS Field Names	170
Usage Notes for SET ACROSSTITLE	171
Placing the ACROSS Title on the Same Line as the ACROSS Values	171
ACROSS Title Spacing	173
Specifying Background Color for ACROSS Values With ACROSSTITLE=SIDE	175
Using Multiple Horizontal (ACROSS) Sort Fields	176
Sorting With Multiple Horizontal (ACROSS) Phrases	176
Collapsing PRINT With ACROSS	177
Compress Report Lines	177
Usage Notes for SET ACROSSPRT	178
Compressing Report Output With SET ACROSSPRT	178
Hiding Null Columns in ACROSS Groups	180
Hide Null ACROSS Columns	180
Usage Notes for Hiding Null Columns Within ACROSS Groups	181
Features Not Supported For Hiding Null ACROSS Columns	181
Hiding ACROSS Groups and Columns Within BY Page Breaks	181
Hiding Null ACROSS Groups	182
Hiding Columns Within ACROSS Groups	184
Hiding Null Columns With Multiple ACROSS Fields	187
Generating Summary Lines and Hiding Null ACROSS Columns	189
Generating Column Totals and Hiding Null ACROSS Columns	190
Using Column Styling and Hiding Null ACROSS Columns	192
Using Column Styling and Hiding Null ACROSS Columns	192
Hiding Null ACROSS Columns in an FML Request	197
Hiding Null ACROSS Columns in an FML Request	197
Controlling Display of Sort Field Values	200
Control Display of Sort Field Values	201
Controlling Display of Sort Field Values on Report Output	201
Reformatting Sort Fields	204
Reformat a Sort Field	204
Usage Notes for Reformatting Sort Fields	205

Reformatting Sort Fields	205
Manipulating Display Field Values in a Sort Group	207
Use WITHIN to Manipulate Display Fields	207
Summing Values Within Sort Groups	208
Creating a Matrix Report	209
Creating a Simple Matrix	209
Creating a Matrix With Several Sort Fields	210
Controlling Collation Sequence	211
Establish Binary or Case-Insensitive Collation Sequence	211
Usage Notes for SET COLLATION	212
Using Binary and Case-Insensitive Collation Sequence for Sorting	212
Using Binary and Case-Insensitive Collation Sequence for Selection	217
Specifying the Sort Order	218
Specify the Sort Order	218
Sorting in Ascending Order	218
Sorting in Descending Order	220
Specifying Your Own Sort Order	221
Define Your Own Sort Order	221
Usage Notes for Defining Your Sort Order	222
Defining Your Row Sort Order	223
Define Column Sort Sequence	224
ACROSS COLUMNS AND phrase	224
Defining Column Sort Sequence	225
Selecting and Assigning Column Titles to ACROSS Values	225
Assign Column Titles To ACROSS Values	225
Usage Notes for Assigning Column Titles to ACROSS Values	226
Selecting and Assigning Column Titles to ACROSS Values	227
Ranking Sort Field Values	227
Rank Sort Field Values	228
Ranking Sort Field Values	228
Ranking and Restricting Sort Field Values	229

DENSE and SPARSE Ranking	230
Optimizing Ranking	230
Control the Ranking Method	231
Usage Notes for SET RANK	232
Ranking Values in a ibi FOCUS Data Source	232
Limiting the Number of Sort Field Values	233
Grouping Numeric Data Into Ranges	235
Define Groups of Equal Range	236
Defining Groups of Equal Ranges	236
Define Equal Ranges	237
Defining Equal Ranges	237
Define Custom Groups of Data Values	238
Defining Custom Groups of Data Values	239
Grouping Numeric Data Into Tiles	240
Group Numeric Data Into Tiles	241
Grouping Data Into Five Tiles	242
Displaying the First Three Tile Groups	244
Displaying Tiles With a Value of Three or Less	245
Grouping Data Into Tiles and Customizing Column Headings	245
Usage Notes for Tiles	246
Restricting Sort Field Values by Highest/Lowest Rank	247
Restrict Sort Field Values by Highest/Lowest Rank	247
Restricting Sort Field Values to a Group	248
Sorting and Aggregating Report Columns	249
Sort and Aggregate a Report Column	249
Sorting and Aggregating Report Columns	250
Sorting, Aggregating, and Ranking Report Columns	251
Sorting and Aggregating Report Columns With COMPUTE	252
Using BY TOTAL on a Calculated Value With an ACROSS Phrase	252
Usage Notes for BY TOTAL	253
Restricting the Number of Columns in a Report	253

Hiding Sort Values	254
Hide Sort Values	254
Hiding Sort Values	254
Sort Performance Considerations	256
Sorting With Multiple Display Commands	257
Using Multiple Display and Sort Fields	258
Controlling Formatting of Reports With Multiple Display Commands	259
Control the Format of Reports With Multiple Display Commands	260
Displaying Reports With Multiple Display Commands	260
Style a Report With SET DUPLICATECOL=ON	262
Styling Rows Associated With a Specific Display Command	262
Stacking Duplicate Columns in Multi-Verb Requests Based on AS Names	264
Stacking Duplicate Columns in Multi-Verb Requests Based on AS Names	264
Improving Efficiency With External Sorts	266
Requirements for External Sorting	266
Usage Notes for External Sorting in Non-Mainframe Environments	266
Determine the Type of Sort Used	267
Control External Sorting	267
Query the Sort Type	268
Providing an Estimate of Input Records or Report Size for Sorting	268
Provide an Estimate of Input Records or Report Size for Sorting	269
Sort Work Files and Return Codes	269
Sort Work Files on UNIX, Windows, and OpenVMS	270
Sort Work Files on IBM i	271
WebFOCUS External Sort Return Codes	271
Mainframe External Sort Utilities and Message Options	272
Select a Sort Utility and Message Options	272
Diagnosing External Sort Errors	273
Trace Sort Processing	273
External Sort Messages and Return Codes	274
Responding to an Indication of Inadequate Sort Work Space	275

Aggregation by External Sort (Mainframe Environments Only)	276
Use Aggregation in Your External Sort	276
Usage Notes for Aggregating With an External Sort	276
Changing Output by Using an External Sort for Aggregation	277
Changing Retrieval Order With Aggregation	278
Set Retrieval Order	278
Displaying the Minimum Value for an Aggregated Alphanumeric Field	279
Creating a HOLD File With an External Sort	280
Create HOLD Files With an External Sort	280
Usage Notes for Creating a HOLD File With an External Sort	281
Hierarchical Reporting: BY HIERARCHY	281
Specify a Hierarchy in a Master File	283
Sample Master File With a Dimension Hierarchy	286
Report on a Hierarchy	288
Reporting on a Dimension Hierarchy	290
Using WHEN to Select Hierarchy Members	293
Using WHERE to Screen Selected Hierarchy Members	295
Selecting Records for Your Report	298
Selecting Records Overview	298
Choosing a Filtering Method	298
Selections Based on Individual Values	299
Select Records With WHERE	299
Usage Notes for WHERE Phrases	300
Selecting Records for Partitioned FOCUS Data Sources	301
Using a Simple WHERE Test	301
Using Multiple WHERE Phrases	302
Controlling Record Selection in Multi-path Data Sources	302
Control Record Selection in Multi-path Data Sources	303
Requirements and Usage Notes for MULTIPATH = COMPOUND	304
Retrieving Data From Multiple Paths	304

MULTIPATH and SET ALL Combinations	307
Rules for Determining If a Segment Is Required	308
Selection Based on Aggregate Values	309
Select Records With WHERE TOTAL	309
Usage Notes for WHERE TOTAL	310
Using WHERE TOTAL for Record Selection	310
Combining WHERE TOTAL and WHERE for Record Selection	311
Applying Selection Criteria to the Internal Matrix Prior to COMPUTE Processing ..	312
Apply WHERE_GROUPED Selection Criteria	312
Using a WHERE_GROUPED Test	312
Usage Notes for WHERE_GROUPED	316
Using Compound Expressions for Record Selection	317
Mixing AND and OR Record Selection Tests	317
Using Operators in Record Selection Tests	318
Operators Supported for WHERE and IF Tests	318
Using Operators to Compare a Field to One or More Values	321
Using IF-THEN-ELSE Logic in a WHERE Clause	323
Types of Record Selection Tests	324
Range Tests With FROM and TO	325
Specify a Range Test (FROM and TO)	325
Range Test With FROM ... TO	326
Range Test With NOT-FROM ... TO	326
Range Tests on Sort Fields With FROM ... TO	326
Range Tests With GE and LE or GT and LT	327
Specify Range Tests (GE and LE)	327
Selecting Values Inside a Range	328
Selecting Values Outside a Range	328
Missing Data Tests	329
Test for Missing Data	329
Test for Existing Data	329
Character String Screening With CONTAINS and OMITS	330

Selecting Records With CONTAINS and OMITS	330
Screening on Masked Fields	331
Screen Fields Based on a Mask (Using LIKE and NOT LIKE)	332
Screen Using LIKE and UNLIKE in an IF Phrase	333
Screen Fields Based on a Mask (Using IS and IS-NOT)	333
Restrictions on Masking Characters	334
Screening on Initial Characters	334
Screening on Characters Anywhere in a Field	335
Screening on Initial Characters and Specific Length	336
Screening on Records of Unspecified Length	336
Deactivate Wildcard Characters	337
Selecting Records With SET EQTEST	337
Using an Escape Character for LIKE	338
Use an Escape Character in a WHERE Phrase	338
Specify an Escape Character for a Mask in an IF Phrase	339
Usage Notes for Escape Characters	340
Using the Escape Character in a WHERE Phrase	340
Using an Escape Character in an IF Phrase	341
Qualifying Parent Segments Using INCLUDES and EXCLUDES	342
Usage Notes for INCLUDES and EXCLUDES	342
Selecting Records With INCLUDES and EXCLUDES	343
Selections Based on Group Key Values	343
Selecting Records Using Group Keys	344
Setting Limits on the Number of Records Read	344
Limit the Number of Records Read	344
Limiting the Number of Records Read	345
Selecting Records Using IF Phrases	346
Select Records Using the IF Phrase	346
Using Multiple IF Phrases	347
Reading Selection Values From a File	347
Read Selection Values From a File: WHERE field IN file	348

Read Selection Values From a File: WHERE field operator (file)	349
Read Selection Values From a File: IF	349
Usage Notes for Reading Values From a File	350
Reading Selection Values From a File (WHERE field IN file)	350
Reading Selection Values From a File With WHERE field operator (file)	351
Reading Selection Values From a File (IF)	352
Assigning Screening Conditions to a File	353
Declare a Filter	354
Usage Notes for Virtual Fields Used in Filters	355
Declaring Filters	355
Activate or Deactivate Filters	356
Activating and Deactivating Filters	357
Query the Status of Filters	358
Querying Filters	358
Preserving Filters Across Joins	360
Preserve Filter Definitions With KEEPFILTERS	361
Preserving Filters With KEEPFILTERS	361
VSAM Record Selection Efficiencies	363
Reporting From Files With Alternate Indexes	364
Creating Temporary Fields	365
What Is a Temporary Field?	365
Types of Temporary Fields	365
Evaluation of Temporary Fields	366
Distinguishing Between Virtual Fields and Calculated Values	366
Selecting a Temporary Field	367
Defining a Virtual Field	368
Usage Notes for Creating Virtual Fields	368
Create a Virtual Field	369
Defining a Virtual Field	372
Redefining a Field	373

Redefining a Field That Has the Same Name in Multiple Segments	374
Defining Multiple Virtual Fields	375
Add a Virtual Field to Existing Virtual Fields	375
Adding Virtual Fields	375
Displaying Virtual Fields	376
Display Virtual Fields	376
Display Virtual Fields	376
Clearing a Virtual Field	376
Clearing Virtual Fields	377
Establishing a Segment Location for a Virtual Field	377
Establishing a Segment Location	378
Defining Virtual Fields Using a Multi-Path Data Source	379
Increasing the Speed of Calculations in Virtual Fields	379
Preserving Virtual Fields Using DEFINE FILE SAVE and RETURN	380
Protect Virtual Fields From Being Overwritten	380
Applying Dynamically Formatted Virtual Fields to Report Columns	381
Define and Apply a Format Field	382
Usage Notes for Field-Based Reformatting	383
Creating Dynamically Formatted Fields	384
Passing Function Calls Directly to a Relational Engine Using SQL.Function	
Syntax	385
Usage Notes for Direct SQL Function Calls	385
Calling the SQL COALESCE Function in a Request	386
Creating a Calculated Value	388
Usage Notes for Calculated Field Values	389
Create a Calculated Value	389
Create a Calculated Value Without a Calculation	391
Calculating a Field Value	391
Using Positional Column Referencing With Calculated Values	392
Using Positional Column Referencing	392
Using ACROSS With Calculated Values	393

Using COMPUTE as Part of a Display Command	393
Using ACROSS With Calculated Values	394
Sorting Calculated Values	395
Screening on Calculated Values	395
Assigning Column Reference Numbers	395
Control the Creation of Column Reference Numbers	396
Using Column Notation in a Report Request	396
Using Column Notation in a Non-FML Request With CNOTATION=ALL	397
Using Column Notation in a Non-FML Request With CNOTATION=PRINTONLY	397
Using CNOTATION=PRINTONLY With Column Numbers in an FML Request	398
Using CNOTATION=PRINTONLY to RECAP Over Contiguous Columns in an FML Request	399
Using CNOTATION=PRINTONLY With Relative Column Addressing in an FML Request	400
Using CNOTATION=PRINTONLY With Cell Notation in an FML Request	401
Using NOPRINT, Field Reformatting, and COMPUTE With Column Notation	402
Using Column Notation With NOPRINT in a non-FML Request	403
Using Cell Notation in an FML Request	406
Usage Notes for Column Numbers	407
Using FORECAST in a COMPUTE Command	407
Calculating Trends and Predicting Values With FORECAST	408
FORECAST Processing	409
Usage Notes for FORECAST	409
FORECAST Limits	410
Distinguishing Data Rows From Predicted Rows	410
Distinguishing Data Rows From Predicted Rows	410
Calculating Trends and Predicting Values With FORECAST	412
FORECAST Processing	413
Calculate Trends and Predict Values	413
Usage Notes for FORECAST	416
FORECAST Limits	417

Using a Simple Moving Average	417
Calculating a New Simple Moving Average Column	418
Using an Existing Field as a Simple Moving Average Column	420
Using Single Exponential Smoothing	422
Calculating a Single Exponential Smoothing Column	423
Using Double Exponential Smoothing	426
Calculating a Double Exponential Smoothing Column	427
Using Triple Exponential Smoothing	428
Calculating a Triple Exponential Smoothing Column	430
Using a Linear Regression Equation	431
Calculating a New Linear Regression Field	432
FORECAST Reporting Techniques	434
Generating Multiple FORECAST Columns in a Request	435
Moving the FORECAST Column	436
Distinguishing Data Rows From Predicted Rows	437
Calculating Trends and Predicting Values With Multivariate REGRESS	438
Create a Multivariate Linear Regression Column	439
Usage Notes for REGRESS	440
Creating a Multivariate Linear Regression Column	440
Using Text Fields in DEFINE and COMPUTE	443
Assigning the Result of an Alphanumeric Expression to a Text Field	444
Creating Temporary Fields Independent of a Master File	444
Define a Function	445
DEFINE Function Limits and Restrictions	446
Defining a Function	447
Display DEFINE Functions	448
Displaying DEFINE Functions	448
Clear DEFINE Functions	449
Including Totals and Subtotals	450
Calculating Row and Column Totals	450

Calculate Row and Column Totals	450
Calculating Row and Column Totals	451
Specifying Column Totals With ON TABLE	452
Using Row and Column Totals in a Matrix Report	453
Renaming Row and Column Totals in Sorted Reports (BY)	453
Including Calculated Values in Row and Column Totals	454
Using ROW-TOTAL With ACROSS and Multiple Display Commands	455
Producing Row Totals for Horizontal (ACROSS) Sort Field Values	458
Produce Row Totals for Horizontal (ACROSS) Sort Field Values	458
Producing Row Totals for Horizontal (ACROSS) Sort Field Values	459
Usage Notes for ACROSS-TOTAL	459
Including Section Totals and a Grand Total	460
Using Section Totals and Grand Totals	461
Including Subtotals	462
Create Subtotals	462
Control Placement of Summary Lines	463
Placing Subtotals Above the Data	464
Usage Notes for Subtotals	466
Generating Subtotals	467
Comparing SUB-TOTAL and SUBTOTAL	468
Recalculating Values for Subtotal Rows	469
Subtotal Calculated Values	469
Using SUMMARIZE	471
Using RECOMPUTE	472
Summarizing Alphanumeric Columns	474
Include All Columns on Summary Lines	475
Including Alphanumeric Fields on Summary Lines	475
Usage Notes for Summarizing Alphanumeric Columns	477
Manipulating Summary Values With Prefix Operators	477
Use Prefix Operators With Summary Values	478
Usage Notes for Summary Prefix Operators	480

Using Prefix Operators With SUBTOTAL	480
Using SUBTOTAL at the Sort Break and Grand Total Levels	482
Differentiating Between Fields With Multiple Prefix Operators	483
Displaying an Alphanumeric Field on a Summary Line	484
Displaying All Fields on a Summary Line	485
Controlling Summary Line Processing	486
Control Summary Line Processing	487
Usage Notes for SET SUMMARYLINES	488
Using SET SUMMARYLINES With SUBTOTAL	489
Using COLUMN-TOTAL With SET SUMMARYLINES=EXPLICIT	490
Using Prefix Operators With Calculated Values	492
Using Prefix Operators With RECOMPUTE	493
Using RECOMPUTE at the Sort Break and Grand Total Levels	495
Using Multiple SUB-TOTAL or SUMMARIZE Commands With Prefix Operators	496
Using Multiple SUB-TOTAL Commands With Prefix Operators	496
Combinations of Summary Commands	498
Using SUBTOTAL and RECOMPUTE in a Request	499
Using SUB-TOTAL With Multiple Summary Commands	501
Using Multiple Summary Commands With Prefix Operators	502
Propagation of Summary Commands With Field Lists	503
Usage Notes for Combinations of Summary Commands	504
Producing Summary Columns for Horizontal Sort Fields	504
Produce a Summary Operation on a Horizontal Sort Field	505
Usage Notes for Summaries on ACROSS Fields	506
Using Summary Commands With ACROSS	508
Subtotaling One Field Within an ACROSS Group	509
Summarizing a Calculated Value in an ACROSS Group	510
Using Prefix Operators in a Summary Command With ACROSS	511
Using Combinations of ACROSS Summary Commands	513
Performing Calculations at Sort Field Breaks	514
Use Subtotals in Calculations	514

Usage Notes for RECAP and COMPUTE	515
Using RECAP	516
Using Multiple RECAP Commands	517
Suppressing Grand Totals	518
Suppress Grand Totals	518
Suppressing Grand Totals	518
Conditionally Displaying Summary Lines and Text	520
Conditionally Displaying Summary Lines and Text	521
Using Expressions	523
Using Expressions in Commands and Phrases	523
Types of Expressions	524
Expressions and Field Formats	526
Assigning a Field Format of Sufficient Length	526
Creating a Numeric Expression	526
Express a Number in Scientific Notation	528
Evaluating a Number in Scientific Notation	529
Arithmetic Operators	529
Order of Evaluation	530
Controlling the Order of Evaluation	531
Using IF-THEN-ELSE Logic in an Arithmetic Expression	532
Evaluating Numeric Expressions With Native-Mode Arithmetic	533
Using Identical Operand Formats With Native-Mode Arithmetic	533
Using Identical Operand Formats (Native-mode Arithmetic)	534
Using Different Operand Formats With Native-Mode Arithmetic	534
Creating a Date Expression	535
Formats for Date Values	536
Base Dates for Date Formats	537
Impact of Date Formats on Storage and Display	537
Performing Calculations on Dates	538
Calculating Dates	538

Cross-Century Dates With DEFINE and COMPUTE	539
Returned Field Format Selection	539
Selecting the Format of a Returned Field	540
Using a Date Constant in an Expression	540
Initializing a Field With a Date Constant	540
Extracting a Date Component	541
Extracting the Month Component From a Date	541
Combining Fields With Different Formats in an Expression	541
Combining Fields With Format YYMD and MDY	542
Assigning a Different Order of Components to a Returned Field	542
Creating a Date-Time Expression	542
Automatic Conversion Between Date and Date-Time Formats	542
Assigning Date and Date-Time Values	544
Comparing Date and Date-Time Values	545
Specify the Order of Date Components in a Date-Time Field	547
Specifying a Date-Time Value	547
Assigning Date-Time Literals	549
Specifying the Order of Date Components for a Date-Time Field	550
Reading Date-Time Values From a Transaction File	551
Using a Date-Time Value in a COMPUTE Command	551
Using a Date-Time Value in WHERE Criteria	552
Using a Date-Time Value in IF Criteria	552
Specifying Universal Date-Time Input Values	553
Manipulating Date-Time Values	553
Testing for Missing Date-Time Values	554
Assigning a Different Usage Format to a Date-Time Column	555
Creating a Character Expression	555
Embedding a Quotation Mark in a Quote-Delimited Literal String	556
Specifying the Data Value O'BRIEN in a Quote-Delimited Literal String	557
Concatenating Character Strings	557
Concatenating Character Strings	558

Using IF-THEN-ELSE Logic in a Character Expression	559
Creating a Variable Length Character Expression	560
Using Concatenation With AnV Fields	560
Using the EDIT Function With AnV Fields	561
Using CONTAINS and OMITS With AnV Fields	561
Using LIKE With AnV Fields	562
Using the EQ, NE, LT, GT, LE, and GE Operators With AnV Fields	563
Using the DECODE Function With AnV Fields	564
Using the Assignment Operator With AnV Fields	564
Creating a Logical Expression	566
Logical Operators	566
Write a Relational Expression	567
Write a Boolean Expression	568
Creating a Conditional Expression	568
Write a Conditional Expression	569
Supplying a Value With a Conditional Expression	569
Defining a True or False Condition	570
Customizing Tabular Reports	572
Producing Headings and Footings	572
Limits for Headings and Footings	573
Report and Page Headings	574
Create a Report Heading	574
Create a Page Heading	575
Creating a Report Heading	575
Creating a Page Heading	576
Creating a Multi-Line Heading	577
Report and Page Footings	578
Create a Report Footing	578
Create a Page Footing	578
Creating a Page Footing	579

Creating Multiple Conditional Headings and Footings	580
Specify a Heading or Footing With a WHEN Clause	580
Usage Notes for Multiple Headings	581
Style a Specific Heading or Footing	581
Using Multiple Headings With WHEN Clauses	581
Styling Multiple Headings With WHEN	583
Subheads and Subfoots	584
Create a Subhead	585
Using Subheads	586
Create Subfoots	587
Usage Notes for Creating Subfoots	588
Using Subfoots	588
Generating a Subfoot Within a Sort Group	589
Creating a Cover Page for Each Sort Group in a Report	591
Using Data in Headings and Footings	592
Insert Data in Headings and Footings	593
Usage Notes for Data in Headings and Footings	593
Using Data in a Heading and Footing	594
Positioning Text	595
Positioning Text	596
Extending Heading and Footing Code to Multiple Lines	597
Extend Heading and Footing Code to Multiple Lines	598
Extending Heading and Footing Code to Multiple Lines	598
Using Data in a Heading	599
Using Direct Operators in Headings and Footings	600
Producing a Free-Form Report	602
Creating Paging and Numbering	603
Specifying a Page Break: PAGE-BREAK	603
Specify a Page Break	603
Usage Notes for Page Breaks	604
Specifying a Page Break	604

Inserting Page Numbers: TABPAGENO	605
Inserting Page Numbers	605
Controlling Report Page Numbering	606
Set the First Page Number for a Report	607
Setting the Number of the First Page of a Report	607
Page Number Commands	609
Suppressing Page Numbers: SET PAGE	610
Suppress Page Numbers	610
Preventing an Undesirable Split: NOSPLIT	611
Prevent an Undesirable Split	611
Usage Notes for Preventing an Undesirable Split	612
Preventing an Undesirable Split	612
Ignoring ON Phrases for Absent Fields	614
Control Processing of ON Phrases	615
Ignoring ON Phrases for Absent Fields	615
Suppressing Fields: SUP-PRINT or NOPRINT	616
Suppress Fields	617
Usage Notes for Suppressing Fields	617
Suppressing Fields	617
Suppressing a Sort Field	619
Reducing a Report's Width: FOLD-LINE and OVER	620
Compressing the Columns of Reports: FOLD-LINE	621
Compress Report Columns	621
Usage Notes for Compressing Report Columns	621
Compressing Report Columns	622
Decreasing the Width of a Report: OVER	622
Decrease the Width of a Report	623
Usage Notes for Decreasing Report Width	623
Decreasing the Width of a Report	623
Positioning Columns: IN	624
Position Columns	624

Usage Notes for Positioning Columns	625
Positioning Columns	625
Positioning Columns With ACROSS	626
Positioning Columns With FOLD-LINE	627
Positioning Columns With OVER	627
Separating Sections of a Report: SKIP-LINE and UNDER-LINE	628
Adding Blank Lines: SKIP-LINE	628
Add Blank Lines	629
Usage Notes for Adding Blank Lines	630
Adding Blank Lines	630
Underlining Values: UNDER-LINE	631
Underline Values	631
Underlining Values	632
Controlling Column Title Underlining Using a SET Command	632
Control Column Title Underlining Using a SET Command	633
Controlling Column Title Underlining Using a SET Command	633
Controlling Column Spacing: SET SPACES	635
Control Column Spacing	635
Controlling Column Spacing	636
Creating New Column Titles: AS	636
Create Column Titles	637
Usage Notes for New Column Titles	637
Creating New Column Titles	638
Customizing Column Names: SET QUALTITLES	639
Customize Column Headings	639
Usage Notes for Qualified Column Titles	639
Column Title Justification	639
Justify Column Titles	640
Usage Notes for Justifying Column Titles	640
Justifying Column Titles	641
Customizing Reports With SET Parameters	641

Use SET Parameters in Requests	641
Setting Parameters in a Report Request	642
Conditionally Formatting Reports With the WHEN Clause	643
Create Conditional Formatting	643
Usage Notes for Conditional Formatting	644
Conditionally Formatting Reports	644
Selectively Displaying a SUBTOTAL and SUBFOOT	645
Selectively Displaying Multiple Subheads	646
Selectively Displaying a Subfoot	648
Using Aggregation in the WHEN Clause	649
Controlling the Display of Empty Reports	650
Control Empty Reports	650
Controlling the Display of Empty Reports	651
Usage Notes for Displaying Empty Reports	652
Controlling the Generation of Blank Lines in Report Output	653
Control Automatic Blank Lines on Report Output	653
Usage Notes for SET DROPBLNKLINE=HEADING	654
Comparing DROPBLNKLINE Parameter Settings	655
Saving and Reusing Your Report Output	660
Saving Your Report Output	660
Naming and Storing Report Output Files	661
Creating a HOLD File	661
Create a HOLD File	662
Create HOLD Files From Hot Screen	665
Using DATASET for HOLD	666
Set the Default HOLD Format	667
Extracting Data to a HOLD File	667
Query a HOLD Master File	668
Reporting Against a HOLD Master File	669
Holding Report Output in ibi FOCUS Format	671

Create HOLD Files in ibi FOCUS Format	672
Operating System Notes for HOLD Files in ibi FOCUS Format	673
Controlling the ibi FOCUS File Structure	674
Creating a HOLD File in ibi FOCUS Format	674
Using PRINT to Create a ibi FOCUS Data Source With a FOCLIST Field	675
Creating a Two-Segment ibi FOCUS Data Source	676
Creating a Three-Segment ibi FOCUS Data Source	677
Controlling Attributes in HOLD Master Files	677
Controlling Field Names in a HOLD Master File	678
Control Field Names in a HOLD Master File	678
Usage Notes for Controlling Field Names in HOLD Files	679
Controlling Field Names in the HOLD Master File	681
Providing Unique Field Names With SET ASNAMES	681
Using SET ASNAMES With the ACROSS Phrase	682
Generating a HOLD File With SET ASNAMES=FLIP	683
Controlling Fields in a HOLD Master File	685
Control Fields in a HOLD File	685
Using HOLDLIST=ALL	686
Using HOLDLIST= PRINTONLY	687
Comparing Master Files Created Using Different HOLDLIST Settings	688
Controlling Attributes in the HOLD Master File	690
Control TITLE and ACCEPT Attributes	691
Controlling TITLE and ACCEPT Attributes in a HOLD Master File	691
Keyed Retrieval From HOLD Files	692
Control Keyed Retrieval for a HOLD File	693
Master File for Keyed Retrieval From a HOLD File	693
Selection Criteria for Keyed Retrieval From an Extract File	694
Using DBMS Temporary Tables as HOLD Files	695
Save Report Output as a Native Temporary Table Using Commands	695
Temporary Table Properties for SAME_DB Persistence Values	697
Column Names in the HOLD File	698

Primary Keys and Indexes in the HOLD File	698
Creating SAVE and SAVB Files	699
Create a SAVE File	699
Creating a SAVE File	701
Create a SAVB File	701
Creating a SAVB File	702
Creating a PCHOLD File	703
Create a PCHOLD File	703
Choosing Output File Formats	704
FORMAT AHTML	705
FORMAT AHTMLTAB	706
FORMAT ALPHA	706
FORMAT APDF	707
FORMAT BINARY	707
FORMAT COMMA	708
FORMAT COM	709
FORMAT COMT	710
FORMAT DATREC	711
FORMAT DB2	711
FORMAT DBASE	711
FORMAT DFIX	712
FORMAT DHTML	712
FORMAT DIF	713
FORMAT DOC	713
FORMAT XLSX	714
FORMAT EXL2K	714
FORMAT EXL2K FORMULA	715
FORMAT EXL2K PIVOT	715
FORMAT EXL97	715
FORMAT FLEX	716
FORMAT FOCUS	716

FORMAT GIF	716
FORMAT HTML	717
FORMAT HTMTABLE	717
FORMAT INGRES	717
FORMAT INTERNAL	718
FORMAT JPEG	718
FORMAT JSCHART	719
FORMAT JSON	719
FORMAT LOTUS	719
FORMAT PDF	720
FORMAT PDF OPEN/CLOSE	721
FORMAT POSTSCRIPT (PS)	721
FORMAT PPT	722
FORMAT PPTX	722
FORMAT REDBRICK	722
FORMAT SQL_SCRIPT	722
FORMAT SQLDBC	723
FORMAT SQLINF	723
FORMAT SQLMAC	724
FORMAT SQLMSS	724
FORMAT SQLODBC	724
FORMAT SQLORA	724
FORMAT SQLPSTGR	725
FORMAT SQLSYB	725
FORMAT SYLK	725
FORMAT TAB	726
FORMAT TABT	726
FORMAT VISDIS	727
FORMAT WK1	728
FORMAT WP	728
FORMAT XFOCUS	730

FORMAT XML	730
Using Text Fields in Output Files	731
Rules for Text Fields in Output Files	731
Applying Text Field Rules in HOLD Files	732
Creating a Delimited Sequential File	732
Create a Delimited Sequential File	733
Usage Notes for HOLD FORMAT DFIX	735
Creating a Pipe-Delimited File	735
Creating a Tab-Delimited File	737
Creating a Delimited File With Blank Spaces Preserved	738
Specifying a Record Delimiter	741
Missing Data in the HOLD File	742
Saving Report Output in INTERNAL Format	743
Suppress Field Padding in HOLD Files	743
Usage Notes for Suppressing Padded Fields in HOLD Files	744
Creating a HOLD File Without HOLD FORMAT INTERNAL	745
Creating a HOLD File With HOLD FORMAT INTERNAL	745
Creating A Subquery or Sequential File With HOLD FORMAT SQL_SCRIPT	746
Create an SQL Script or Sequential File Using HOLD FORMAT SQL_SCRIPT	747
Creating an SQL Script File Using HOLD FORMAT SQL_SCRIPT	747
Creating a Sequential File Using HOLD FORMAT SQL_SCRIPT	748
Creating a Structured HOLD File	749
Activate Structured HOLD Files for a Request	750
Create a Structured HOLD File	751
Specify Options for Generating Structured HOLD Files	751
Creating a Structured HOLD File in ALPHA Format	752
Creating a Structured HOLD File in ibi FOCUS Format	753
Reconstituting a Structured HOLD File	754
Excluding Fields From Structured HOLD Files	755
Elements Included in a Structured HOLD File	756
Elements Not Included in a Structured HOLD File	757

Structural and Behavioral Notes	758
Styling Reports	761
Introduction to Styled Reports	761
Specifying Formatting for the Order Revenue Report	763
Choosing a Type of Style Sheet	765
Choosing an Output Format	766
Sample FOCUS StyleSheet Files	768
Styling Reports With StyleSheets	770
What Is a StyleSheet?	770
What Is a Style?	771
Reproducing StyleSheet Examples	771
Comparison of Reports With and Without StyleSheets	772
Creating a StyleSheet	773
Create a StyleSheet in a Report Request	774
Creating a StyleSheet Within a Report Request	775
Activate an Existing StyleSheet File	775
Include a StyleSheet File in Another StyleSheet	776
Including a StyleSheet File in Another StyleSheet	777
StyleSheet Syntax	778
Improving FOCUS StyleSheet Readability	779
Adding a Comment to a FOCUS StyleSheet	780
Checking StyleSheet Syntax	781
Check StyleSheet Syntax	781
Creating a Styled Report	781
Create a Styled Report	781
Styling the Page Layout	782
Selecting Page Size, Orientation, and Color	782
Page Size, Orientation, and Color Attributes	783
Set Page Size	783
Set Page Orientation	787

Control the Paper Source Used by a PostScript Printer	788
Set Page Color	788
Setting Page Color	789
Setting Page Margins	789
Page Margin Attributes	790
Set the Unit of Measurement	790
Set Margin Size	791
Displaying Current Settings: The ? SET STYLE Query	792
Display Current Settings	792
Specifying Font Format in a Report	793
Specify Font Size in a Report	793
Usage Notes for Changing Font Size	794
Specify Bold or Italic Font Style in a Report	794
Adding and Removing Inherited Font Style in a Report	795
Specify Font Color in a Report	796
Specify Background Color in a Report	797
Color Values in a Report	798
Specifying Fonts for Reports	801
Specify Fonts in a Report	801
Specifying Multiple Fonts in an HTML Report	802
Specify the Default Browser Fonts for HTML Reports	802
Specifying Default Browser Fonts	803
Identifying Report Components	804
Identifying an Entire Report, Column, or Row	806
Identify the Entire Report	808
Identify an Entire Column	808
Identifying an Entire Column	810
Identifying an Entire Horizontal (ACROSS) Column	811
Identify an Entire Financial Modeling Language (FML) Row	813
Identifying an Entire FML Row	813
Identify an Entire Total or Subtotal Row	814

Identifying an Entire Total Row	815
Identifying a Row Total	815
Identifying Data	816
Identify All Data	817
Identifying All Data in a Report	818
Identify a Column of Data	819
Identifying a Column of Data	819
Identify a Row of Horizontal Sort (ACROSS) Data	820
Identifying a Row of Horizontal Sort (ACROSS) Data	820
Identifying Totals and Subtotals	822
Identify a Grand Total, Subtotal, or Subtotal Calculation	823
Identifying Subtotals and the Grand Total	824
Identifying a Subtotal Calculation (RECAP/COMPUTE)	826
Styling Multiple RECAP Statements in a Matrix	827
Identifying Tags for SUBTOTAL and GRANDTOTAL Lines	827
Style Subtotal and Grand Total Tags	828
Styling SUBTOTAL and GRANDTOTAL Tags	829
Identifying a Heading, Footing, Title, or FML Free Text	830
Identifying a Column or Row Title	831
Identify a Column Title	831
Identify a Horizontal Sort Title or Value	832
Identifying Column Titles and Horizontal Sort (ACROSS) Values	832
Identify Free Text in an FML Report	833
Identifying Free Text in an FML Report	834
Create a Custom Report Title	835
Identifying a Heading or Footing	836
Identify a Heading or Footing	837
Identify an Individual Line in a Heading or Footing	838
Identifying an Individual Line in a Heading	839
Identify a Text String in a Heading or Footing	840
Identifying a Text String in a Heading Using Spot Markers	841

Identify an Embedded Field in a Heading or Footing	842
Identifying Embedded Fields in a Heading	843
Insert the Total Page Count	844
Inserting the Current Page Number and the Total Page Count	844
Display the Total Number of Pages Within Each Sort Group	846
Paginating Within a Sort Group	846
Identifying a Page Number, Underline, or Skipped Line	848
Identify a Page Number, Underline, or Skipped Line	849
Identifying Underlines and Page Numbers	850
Identifying Skipped Lines	851
Extend an Underline to the Entire Report Column	852
Usage Notes for the EXTUNDERLINE Attribute	853
Extending an Underline to the Entire Report Column	853
Section Separation Features	856
Format a Blank Line	857
Format an Underline	857
Formatting a Sort Group Underline	858
Add or Remove a Report Component Underline	859
Remove an Underline From a Column Title	860
Adding Column Underlines and Removing Column Title Underlines	860
Reusing FOCUS StyleSheet Declarations With Macros	861
Defining a FOCUS StyleSheet Macro	862
Define a FOCUS StyleSheet Macro	862
Applying a FOCUS StyleSheet Macro	862
Apply a FOCUS StyleSheet Macro	863
Defining, Applying, and Overriding a FOCUS StyleSheet Macro	863
FOCUS StyleSheet Attribute Inheritance	865
FOCUS StyleSheet Inheritance Hierarchy	865
Augmenting Inherited FOCUS StyleSheet Attributes	866
Overriding Inherited FOCUS StyleSheet Attributes	867
Conditionally Formatting in a StyleSheet	868

Applying Sequential Conditional Formatting	869
Conditionally Format in a StyleSheet	870
Applying Basic Conditional Formatting	872
Applying Conditional Formatting to a Column	873
Applying Conditional Formatting Based on a Hidden (NOPRINT) Field's Values	874
Applying Conditional Formatting to a Sort Group	875
Using Sequential Conditional Formatting	878
Applying Conditional Formatting to Forecasted Values	880
Conditional Styling Based on ACROSS Values	881
Conditionally Styling an ACROSS Value	881
Using WHEN With ACROSSCOLUMN	883
Field Interaction When Using ACROSSCOLUMN and WHEN	883
Using ACROSSCOLUMN With WHEN	884
Using Conditional Grid Formatting in a Field	885
Creating a Report Using Conditional Grid Formatting	885
Cascading Style Sheets	887
What Are Cascading Style Sheets?	887
Benefits of Cascading Style Sheets	887
The Notion of Browser Dependence	888
Types of Cascading Style Sheets	888
Cascading Style Sheets and Precedence Rules	889
Cascading Style Sheet Formatting Statements: Rules and Classes	890
Selecting a CSS Rule	891
Naming CSS Classes	891
Inheritance and CSS	891
Inheriting Report Column Formatting From a TD Element	892
Generating an Internal Cascading Style Sheet	894
Selecting a Unit of Measurement	894
Generate an Internal Cascading Style Sheet	895
Working With External Cascading Style Sheets	896

Applying CSS Styles	896
Use the CLASS Attribute to Apply CSS Formatting	897
Using an External CSS - A Graphical Overview	898
Format a Tabular Report With an External CSS	899
Formatting a Report Using a Cascading Style Sheet	900
Combining CSS Styling With Other Formatting Methods	903
Combining an External CSS With a FOCUS StyleSheet	903
Combining an External CSS With TABLE Language Formatting	905
Linking to an External Cascading Style Sheet	905
Use the CSSURL SET Parameter to Link to an External CSS	906
Linking to an External cascading style sheet Using the CSSURL Attribute	906
Use the CSSURL Attribute to Link to an External CSS	908
FAQ About Using External Cascading Style Sheets	908
Troubleshooting Cascading Style Sheets	910
Advanced StyleSheet Features	913
Positioning a Report Component	913
Positioning Attributes	914
Specify the Starting Position of a Column	915
Set a Starting Position for a Heading or Footing	915
Set a Starting Position for a Heading or Footing Element	916
Specifying an Absolute Starting Position for a Column	917
Specifying a Relative Starting Position for a Column	918
Setting an Absolute Starting Position for a Heading Item	919
Setting a Relative Starting Position for a Heading Item	920
Aligning a Heading Item With a Column	921
Add Blank Space Around a Report Component	922
Adding Blank Space Above Data Values	924
Adding Blank Space to Separate Heading Text From Grid Lines in a PDF Report	925
Controlling Column Title Underlining Using a StyleSheet Attribute	925
Control Column Title Underlining Using a StyleSheet Attribute	926

Controlling Column Title Underlining Using a StyleSheet Attribute	926
Arranging Pages and Columns on a Page	928
Column Arrangement Features	929
Determining Column Width	929
Determine Column Width (HTML)	930
Using Default Column Width (HTML)	930
Determine Column Width (PDF or PS)	931
Determining Column Width (PDF)	932
Wrapping and Justifying Report Components	933
Controlling Wrapping of Report Data	933
Control Wrapping of Report Data Using a StyleSheet Attribute	935
Allowing the Web Browser to Wrap Report Data	936
Wrapping Columns With OVER	937
Control Spacing Between Wrapped Lines	938
Specifying Spacing for Wrapped Lines	939
Wrap ACROSS Values	941
Wrapping ACROSS Values in PDF Report Output	942
OVER With Blank Column Titles	944
Using OVER and WRAP With Blank AS Names	944
OVER and WRAP With Non-Blank Column Titles	946
Using OVER and WRAP With Column Titles	946
Usage Notes for WRAPGAP	947
Controlling Wrapping With Alternative Methods	947
Set Commands that Affect Wrapping in a Report	948
Control Wrapping Using SQUEEZE	948
Control Wrapping Using SQUEEZE as a SET Command	949
Usage Notes for WRAP and SQUEEZE	950
Working With Multi-Table HTML Reports	950
Displaying a Multiple-Table HTML Report	951
Justifying Report Columns	952
Justify a Report Column	952

Justifying Data in a Report Column	953
Justifying a Heading or Footing	954
Justify a Heading or Footing in a StyleSheet	955
Centering All Lines in a Multiple-Line Report Heading	955
Justification Regions and Behavior	956
Justifying a Column Title	957
Justify a Column Title Using a StyleSheet	957
Using a StyleSheet to Justify Column Titles for Display and BY Fields	958
Using a StyleSheet to Justify a Column Title for ACROSS and ROW-TOTAL Fields	959
Using a StyleSheet to Justify a Column Title for a Calculated Value	960
Justifying a Label for a Subtotal or Grand Total	961
Justifying Subtotal and Grand Total Labels	961
Alignment of Fields in Reports Using OVER in PDF Report Output	962
Control GAP Placement on Reports	964
Comparing External Gaps With Internal Gaps	964
Using GAPINTERNAL in a Report	965
Aligning Heading and Footing Elements	970
Aligning a Heading or Footing Element in an HTML, EXL2K, or PDF Report	973
Align a Heading or Footing Element in an HTML Report	974
Aligning Elements in a Page Heading Using a Separate HTML Table	975
Aligning Subfooting Items With Report Columns in PDF Report Output	976
Using OVER With HEADALIGN=BODY in a PDF Report	978
Aligning a Heading or Footing Element Across Columns in an HTML or PDF Report	979
Align a Heading or Footing Element Across Columns	980
Comparing Output Generated With HEADALIGN Options	981
Aligning and Styling a Text Field in a Sort Footing	984
Aligning a Field Value Across Multiple Columns in a PDF Report	986
Aligning Content in a Multi-Line Heading or Footing	988
Align Heading Text and Data in Columns	988
Line and Item Formatting in a Multi-Line Heading or Footing	991

Aligning Data and Text in a Multi-Line Heading or Footing	991
Aligning Decimals in a Multi-Line Heading or Footing	993
Measure for Column Width and Decimal Alignment	994
Combining Column and Line Formatting in Headings and Footings	995
Combining Column and Line Formatting to Align Items in a Sort Heading	995
Support for Repeated Headings and Footings on Panels in PDF Report Output ..	1000
Repeat Heading Elements on Panels	1000
Repeating All Headings and Footings on Report Panels	1002
Repeating a Subfoot on Panels in PDF Report Output	1006
Repeating Styled Headings and Footings on Paneled Pages	1011
Adding Grids and Borders	1016
Grid Display Attributes	1017
Control Grid Display in HTML Reports	1018
Add and Format Borders	1018
Inserting and Formatting a Border	1021
Applying Grid Lines to All Cells of an HTML Report	1022
Insert Inner and Outer Borders Within Headings or Footings in PDF Reports	1023
Controlling Borders Within Heading and Footing Elements in PDF Report Output ..	1026
Align Subheading and Subfooting Margins With the Report Body	1028
Considerations for Aligning Subheading and Subfooting Margins With the Report Body	1029
Aligning Subheading and Subfooting Margins in a Single Panel PDF Report	1033
Aligning Subheading and Subfooting Margins in a Multi-Panel Report	1037
Add and Adjust Grid Lines (PDF or PS)	1041
Applying Grid Lines to Report Data (PDF)	1041
Displaying Superscripts On Data, Heading, and Footing Lines	1042
Display Superscripts on Report Data, Heading, and Footing Lines	1043
Displaying Superscripts in Data and Footing Lines in PDF Output	1044
Adding an Image to a Report	1046
Image Attributes	1047
Add an Image to an HTML Report	1048

Specifying a URL	1050
Adding an Image to an HTML Report Heading	1050
Using a File Name in a Data Source Field in an HTML Report	1051
Supplying an Image Description Using the ALT Attribute	1053
Add a Background Image	1054
Adding a Background Image	1055
Add an Image to a PDF, PS, or HTML Report With Internal Cascading Style Sheet	1055
Adding a GIF Image to an HTML Report With Internal Cascading Style Sheet	1058
Adding a GIF Image to a PDF Report	1059
Linking in a Report	1060
Linking to a URL	1060
Link to a URL	1060
Linking to a URL	1061
Linking to a JavaScript Function	1062
Link to a JavaScript Function	1063
Linking With Conditions	1064
Link With Conditions	1064
Linking With Conditions	1065
Linking From a Graphic Image	1066
Specify Links From a Graphic Image	1066
Specifying a Link From an Image	1067
Specifying a Base URL	1068
Specify a Base URL	1069
Specifying a Base URL	1069
Specifying a Target Frame	1069
Specify a Target Frame	1070
Specify a Default Target Frame	1071
Specifying a Target Frame	1071
Linking Report Pages	1072
Link Report Pages	1072

Linking Report Pages Through Images in a Heading	1073
Linking Pages Through Page Number and Heading Elements	1074
Defining a Hyperlink Color for a Report Component	1076
Define a Hyperlink Color	1076
Defining a Hyperlink Color	1076
Working With Mailing Labels and Multi-Pane Pages	1078
Attributes for Mailing Labels and Multi-Pane Printing	1078
Set Up a Report to Print Mailing Labels	1079
Print Mailing Labels or a Multi-Pane Report	1080
Printing Mailing Labels	1081
Printing a Multi-Page Report	1082
Choosing a Styled Display Format	1083
Report Display Formats	1083
Choose a Display Format Using PCHOLD	1084
Choose a Display Format Using SET ONLINE-FMT	1086
Specifying MIME Types for WebFOCUS Reports	1087
Preserving Leading and Internal Blanks in Report Output	1088
Preserve Leading and Internal Blanks in HTML and EXL2K Reports	1088
Preserving Leading and Internal Blanks in HTML and EXL2K Report Output	1089
Using Web Display Format: HTML	1090
Usage Notes for HTML Report Output	1090
Creating HTML Reports With Absolute Positioning	1091
Create Web Archive Report Output	1091
Create a DHTML Report	1091
Usage Notes for Format DHTML	1092
Creating a DHTML Report	1092
Using Print Display Formats: PDF, PS	1093
Required Files and DDNAMES	1094
Using PDF Display Format	1095
Compress a PDF Output File	1096

Displaying Watermarks in PDF Output	1096
Inserting Images in PDF Reports With Backcolor	1097
Inserting Transparent Images Into a PDF Report	1097
Features Supported	1099
Limits	1100
Usage Notes	1100
Scaling PDF Report Output to Fit the Page Width	1100
Scale PDF Report Output to Fit the Page Width	1100
Usage Notes for PAGE-SCALE	1101
Scaling PDF Report Output to Fit the Page Width	1101
Aligning a PDF Report Within a Page	1104
Left-Aligning a PDF Report Within a Page	1105
Centering a PDF Report Within a Page	1106
Right-Aligning a PDF Report Within a Page	1107
WebFOCUS PDF Report Accessibility Support	1108
Controlling PDF Code For Accessibility	1109
Control PDF Code Accessibility	1109
Controlling PDF Code for Accessibility	1110
Aligning Elements in a Page Heading With Column Data	1113
Align Elements in a Page Heading With Column Data	1114
Aligning Elements in a Page Heading to Column Data	1114
Adding Bookmarks	1117
Adding Bookmarks to the Compound Layout	1118
Adding Descriptive Text to an Image	1122
Add Descriptive Text to an Image	1123
Adding Descriptive Text to an Image	1123
Describing Drill Down Information	1124
Add Descriptive Drill Down Information	1125
Accessibility Limitations	1127
Specifying the Main Document Heading	1128
Specifying the Main Document Heading	1128

Using PostScript (PS) Display Format	1131
Select Paper Size in a PostScript (PS) Report	1132
Selecting Paper Size Using SET Command in a PostScript Report	1133
FOCUS Font Support	1134
Support for the Symbol Font	1135
How FOCUS Uses Type 1 Fonts	1135
Adding PostScript Type 1 Fonts for PS and PDF Formats	1137
Configure Type 1 PostScript Fonts on the Windows and UNIX Platforms	1137
Configure Type 1 PostScript Fonts on z/OS	1139
Add Fonts to the Font Map	1140
FOCUS StyleSheet Declaration	1144
Editing the Font Map File	1144
The FOCUS Default Font Map	1144
Define a Default Font in the Font Map	1145
Embedding TrueType Fonts Into WebFOCUS PDF Reports Generated in Windows	1147
Add TrueType Fonts for Embedding Into PDF Output Files	1147
Embedding TrueType Fonts in a PDF Output File	1153
Creating a Compound PDF or PS Report	1155
Create a Compound PDF or PS Report	1155
Creating a Compound PDF Report	1157
Displaying An and AnV Fields With Line Breaks	1160
Display An and AnV Fields Containing Line Breaks on Multiple Lines	1161
Displaying an Alphanumeric Field With Line Breaks in a PDF Report	1161
Using an Alphanumeric Field With a Line Break in a Subfoot	1162
Creating PDF Files on z/OS for Use With UNIX Systems	1164
Specify Line Termination Characters When Creating a PDF File	1164
Required PDFLINETERM Settings Based on Environment	1165
Using Excel Display Formats: XLSX, EXL2K, EXL97	1166
Viewing Excel Workbooks in the Browser vs. the Excel Application	1167
Redirection and Excel Drilldown Reports	1168

Assigning XLSX Format to Your Report Output	1169
Overview of XLSX Format	1170
Building the .xlsx Workbook File	1170
Select the Method for Zipping the .xlsx File Using EXCELSERVURL	1171
Designate C-Based Zip Local Mode for Zipping the .xlsx File	1172
Building the XLSX Workbook File	1172
Building the XLSX Workbook File	1172
Building the .xlsx Workbook File	1173
Select the Method for Zipping the .xlsx File	1174
Generate an Excel 2007 or 2010 Workbook	1175
Opening EXL07 Report Output in Excel 2000/2003	1175
Formatting Values Within Cells in XLSX Report Output	1177
Displaying Formatted Numeric Values in XLSX Report Output	1178
Passing Numeric Formats to XLSX Report Output	1179
Using Numeric Formats in Report Headings and Footings	1181
Using Numeric Format Punctuation in Headings and Footings	1181
Passing Dates to XLSX Report Output	1182
Translating FOCUS Dates to Excel 2007/2010 Dates	1182
Passing Dates Without a Day Component	1183
Passing FOCUS Dates With and Without a Day Component to XLSX Report Output	1184
Passing Date Components for Use in Excel Formulas	1184
Passing Numeric Date Components to XLSX Report Output	1184
Passing Quarter Formats	1185
Passing Dates With a Quarter Component to Excel 2007	1185
Passing Date Components Defined as Translated Text	1186
Passing Date Components Defined as Translated Text to XLSX Report Output	1187
Usage Notes for Date Values in XLSX Report Output	1187
Passing Date-Time to XLSX	1188
Passing Date-Time to XLSX	1188
Generating Native Excel Formulas in XLSX Report Output	1189
Understanding Formula Versus Value	1189

Translation Support for FORMAT XLSX FORMULA	1190
Save Reports as FORMAT XLSX FORMULA	1191
Generating Native Excel Formulas for Column Totals	1192
Generating Native Excel Formulas for Row Totals	1193
Generating Native Excel Formulas for Calculated Values	1194
Generating a Native Excel Formula for a Function	1195
Generating a Formula With Recomputed Values	1196
Generating a Formula With Recomputed Values	1196
Using XLSX FORMULA With Prefix Operators	1198
Using a Summary Prefix Operator With FORMAT XLSX FORMULA	1200
Using a Prefix Operator on a Display Command With FORMAT XLSX FORMULA	1201
NODATA With Formulas	1201
Usage Notes for XLSX With Formulas	1202
Controlling Column Width and Wrapping in XLSX Report Output	1202
Set Column Width in XLSX Report Output	1203
Wrap Data in XLSX Report Output	1204
Controlling Column Width and Wrapping in XLSX Report Output	1205
Preserving Leading and Internal Blanks in Report Output	1206
Preserve Leading and Internal Blanks in XLSX Reports	1207
Preserving Leading and Internal Blanks in XLSX Report Output	1208
Excel Page Settings	1210
Define Excel Page Settings	1211
Inserting Text and Images Into XLSX Workbook Headers and Footers	1212
Insert Text and Images Into XLSX Workbook Headers and Footers	1212
Inserting Images in Excel Headers and Footers and Defining Page Settings	1213
Inserting Text and Images in Excel Report Output	1216
Synchronizing FOCUS Page Breaks With Excel Page Breaks	1217
Control Synchronization of FOCUS Page Breaks With Excel Page Breaks	1217
Synchronizing FOCUS Page Breaks With Excel Page Breaks in Format XLSX Report Output	1218
Adding an Image to a Report	1220

Inserting Images Into Excel XLSX Reports	1221
Insert Images Into FOCUS Report Elements in XLSX Reports	1221
Adding a GIF Image to a Single Table Request	1223
Inserting Images Into XLSX Workbook Headers and Footers	1225
Insert Images Into Excel Headers and Footers	1226
Inserting Images in Excel Headers and Footers and Defining Page Settings	1227
Usage Notes for Inserting Images Into XLSX Worksheet Headers and Footers	1229
Displaying Watermarks on XLSX Output	1230
Placing a Watermark in an XLSX Header	1230
Creating Excel 2007/2010 Worksheets Using Templates	1231
Create an EXL07 Report Using Any Supported Template File Type	1233
Usage Notes for EXL07 Templates	1233
Creating Excel Table of Contents Reports	1234
Use the Excel Table of Contents Feature	1234
Creating a Simple BYTOC Report	1234
How to Name Worksheets	1235
Naming XLSX Worksheets With Case Sensitive Data	1235
Overcoming the Excel 2007 and 2010 Row Limit Using Overflow Worksheets	1236
Enable Overflow Worksheets	1237
Usage Notes for XLSX Overflow Worksheets	1238
Creating Overflow Worksheets	1239
Creating Overflow Worksheets With FOCUS Page Breaks	1241
Generating XLSX Compound Reports Using the OPEN, CLOSE, and NOBREAK Keywords	1243
Guidelines for Producing Excel Compound Reports Using XLSX	1244
Creating a Simple Compound Report Using XLSX	1245
Creating a Compound Report Using NOBREAK	1246
Format XLSX Limitations	1248
Assigning EXL2K Format to Your Report Output	1248
Creating an EXL2K Report	1249
Create a Styled EXL2K File	1250

Usage Notes for EXL2K Output Files	1251
Font Support for EXL2K Format	1251
National Language Support With EXL2K	1252
Set the Default Language	1252
Identifying Null Values in EXL2K Output Files	1252
Identify Null Values in EXL2K Reports	1252
Identifying Null Values in EXL2K Report Output	1253
Displaying Formatted Numeric Values in EXL2K Report Output	1255
Displaying Formatted Numeric Data in EXL2K Report Output	1256
Usage Notes for Numeric Formats	1258
Passing FOCUS Dates to Excel 2000/2003	1259
Displaying Formatted Dates in EXL2K Report Output	1259
Usage Notes for Date Formats	1261
Using Date Separators in Excel	1261
Passing Dates With Translated Text to Excel 2000/2003	1261
Pass Translated Dates to Excel 2000/2003 as Date Values	1262
Usage Notes for SET EXL2KTXTDATE	1262
Passing Dates With Translated Text to Excel 2000/2003	1263
Passing Dates Without a Day Component	1264
Passing FOCUS Dates With and Without a Day Component to Excel 2000/2003	1265
Passing Date Components for Use in EXL2K FORMULA Reports	1266
Passing Numeric Date Components to Excel 2000/2003	1266
Passing Quarter Formats	1267
Passing Dates With a Quarter Component to Excel 2000/2003	1267
Passing Date Components Defined as Translated Text	1268
Passing Date Components Defined as Translated Text to Excel 2000/2003	1268
Controlling Column Width and Wrapping in EXL2K Report Output	1269
Wrap Data in EXL2K Report Output	1269
Set Column Width in EXL2K Report Output	1270
Controlling Column Width and Wrapping in EXL2K Report Output	1271
Locking Columns in EXL2K Report Output	1273

Enable Worksheet Locking	1273
Lock Specific Cells Within a Worksheet	1274
Locking an Entire EXL2K Workbook	1274
Locking a Single Column on an EXL2K Workbook	1275
Generating Native Excel Formulas in EXL2K Report Output	1276
Save Reports as FORMAT EXL2K FORMULA	1277
Generating Native Excel Formulas for Column Totals	1277
Generating Native Excel Formulas for Row Totals	1278
Generating Native Excel Formulas for Calculated Values	1279
Generating a Native Excel Formula for a Function	1280
Generating a Formula With Recomputed Values	1281
Generating a Formula With Recomputed Values	1281
Translation Support for FORMAT EXL2K FORMULA	1283
Using EXL2K Formula With Prefix Operators	1285
Using a Summary Prefix Operator With Format EXL2K FORMULA	1286
Using PivotTables in EXL2K Report Output	1287
View the PivotTable Toolbar in Excel 2000/2003	1288
How TABLE Elements Appear in a Pivot Table	1288
Effect of TABLE Syntax Elements on PivotTables	1290
Enabling PivotTables	1291
Enable the PivotTable	1291
Usage Notes for PivotTable Requests	1291
Using the EXL2K PIVOT Option	1292
Designating CACHEFIELDS in PivotTables	1293
Usage Notes for Specifying CACHEFIELDS	1293
Using CACHEFIELDS With EXL2K PIVOT	1294
Designating PAGEFIELDS in PivotTables	1295
Using FORMAT EXL2K PIVOT With PAGEFIELDS	1295
Creating EXL2K Reports Using an Excel Template	1296
Support for Excel Templates With EXL2K Display Formats	1297
Create a Report Using an Excel Template	1298

Utilizing Excel Named Ranges	1298
Use Excel Named Ranges	1299
Using Excel Named Ranges	1299
Rules for Excel Named Ranges	1300
Support for Excel Named Ranges	1301
Creating Excel Table of Contents Reports	1301
Use the Excel Table of Contents Feature	1302
Limitations of TOC Reports	1302
Creating a Simple TOC Report	1302
How to Name Worksheets	1303
Naming EXL2K Worksheets with Case Sensitive Data	1304
Using Case Sensitive Data in an EXL2K TOC Report	1304
Using Case Sensitive Data as Worksheet Names	1305
Creating Unique Case Sensitive Sheet Names	1305
Overcoming the Excel 2003 65K Row Limit Using Overflow Worksheets	1306
Enable Overflow Worksheets	1307
Usage Notes for Excel 2003 Overflow Worksheets	1308
Creating Overflow Worksheets With EXL2K Report Output	1309
Creating Overflow Worksheets With FOCUS Page Breaks	1311
Providing a Tooltip on a Drilldown Hyperlink for EXL2K Reports	1313
Provide a ToolTip for a Drilldown Hyperlink	1313
Usage Notes for Drilldown Hyperlinks With EXL2K Report Output	1315
Providing a Tooltip for a Drilldown Link in a Footing	1315
Embedding a WebFOCUS Report in an Excel 2000/2003 Workbook	1317
Embedding a WebFOCUS Report in a Customized Excel 2000/2003 Worksheet	1320
Tips for Populating Excel Worksheets With WebFOCUS Reports	1325
Creating a Compound Excel Report	1325
Guidelines for Using the OPEN, CLOSE, and NOBREAK Keywords and SET COMPOUND	1326
Guidelines for Producing Excel Compound Reports	1327
Creating a Simple Compound Report Using EXL2K	1328

Creating a Compound Report With Pivot Tables and Formulas	1330
Creating a Compound Report Using NOBREAK	1333
Transferring EXL2K Formatted Files Using FTP	1336
Important Considerations for Transferring EXL2K-generated Files	1337
Viewing a Report in EXL97 Format	1337
Create a Styled Excel 97 File	1337
Creating an EXL97 Output File	1338
Limitations for FORMAT EXL97	1339
Embedding a WebFOCUS Report in an Excel 97 Spreadsheet	1340
Create a Web Query (IQY) File	1341
Embedding a WebFOCUS Report in an Excel 97 Spreadsheet	1342
Deploying a Worksheet With a WebFOCUS Web Query	1347
Deploying a Worksheet With a WebFOCUS Web Query to a Web Server	1347
Using PowerPoint PPT Display Format	1349
Using PowerPoint PPT Templates	1350
Create PowerPoint PPT Report Output	1350
Using a PowerPoint PPT Template	1351
Using PowerPoint PPTX Display Format	1351
Create PowerPoint PPTX Report Output	1352
Using PowerPoint PPTX Templates	1352
Create PowerPoint PPTX Report Output	1353
Building the .pptx Presentation File	1353
Select the Method for Zipping the .pptx File	1354
Usage Notes for PPTX	1355
Format PPTX Limitations	1355
Handling Records With Missing Field Values	1356
Irrelevant Report Data	1356
Irrelevant Report Data	1356
Missing Field Values	1358
Counting With Missing Values	1359

Averaging With Missing Values	1359
MISSING Attribute in the Master File	1359
Handling Missing Values With the MISSING Attribute	1360
MISSING Attribute in a DEFINE or COMPUTE Command	1361
Specify Missing Values in a DEFINE or COMPUTE Command	1362
Handling Missing Values for a Virtual Field With MISSING OFF	1363
Handling Missing Values for Virtual Fields With SOME and ALL	1364
Setting MISSING ON Behavior for DEFINE and COMPUTE	1366
Setting a Default Value for MISSING ON in DEFINE and COMPUTE	1367
Testing for Missing Values in IF-THEN-ELSE Expressions	1368
Using SET MISSINGTEST With IF-THEN-ELSE Expressions	1370
Using SET MISSINGTEST With IF-THEN-ELSE Expressions	1371
Testing for a Segment With a Missing Field Value	1372
Test for a Segment With a Missing Field Value	1372
Testing for a Missing Field Value	1373
Testing for an Existing Field Value	1373
Testing for a Blank or Zero	1375
Excluding Missing Values From a Test	1375
Preserving Missing Data Values in an Output File	1376
Distinguish Missing Data in an Extract File	1376
Incorporating MISSING Values in an Extract File	1377
Store Missing Data in HOLD Files	1378
Usage Notes for Holding Missing Values	1378
Holding Missing Values Using HOLDMISS	1378
Propagating Missing Values to Reformatted Fields in a Request	1379
Control Missing Values in Reformatted Fields	1380
Controlling Missing Values in Reformatted Fields	1380
Usage Notes for SET COMPMISS	1381
Handling a Missing Segment Instance	1382
Reporting Against Segments Without Descendant Instances	1383
Reporting Against Segments With Descendant Instances	1384

Including Missing Instances in Reports With the ALL. Prefix	1384
Including Missing Segment Instances With the ALL. Prefix	1385
Including Missing Instances in Reports With the SET ALL Parameter	1386
Include a Parent Instance With Missing Descendants	1387
Including Missing Segment Instances With SET ALL	1387
Control Short Path Processing In a Left Outer Join	1388
Usage Notes for SET SHORTPATH = SQL	1389
Controlling Outer Join Processing	1389
Finding Host Records That Have No Matching Cross-Referenced Records	1392
Testing for Missing Instances in ibi FOCUS Data Sources	1392
Testing for a MISSING Instance	1392
Setting the NODATA Character String	1393
Set the NODATA String	1393
Setting NODATA Not to Display Characters	1393
Setting the NODATA Character String	1394
Joining Data Sources	1396
Types of Joins	1396
Joined Data Structure	1397
Data Sources You Can and Cannot Join	1398
Notes on DBA Security for Joined Data Structures	1398
Unique and Non-Unique Joined Structures	1399
A Unique Equijoin Structure	1399
A Non-Unique Equijoin Structure	1400
Correct for Lagging Values With a Unique Join	1401
Correcting for Lagging Values in a Procedure With Unique Segments and Multiple Children	1402
Recursive Joined Structures	1403
Understanding Recursive Joined Structures	1403
Usage Notes for Recursive Joined Structures	1405
Using Recursive Joined Structures	1406
How the JOIN Command Works	1408

Increasing Retrieval Speed in Joined Data Sources	1409
Creating an Equijoin	1409
Join Real Fields	1410
Creating a Simple Unique Joined Structure	1413
Creating an Inner Join	1413
Creating a Left Outer Join	1415
Creating a Right Outer Join	1416
Creating Two Inner Joins With a Multipath Structure	1418
Requirements for Cross-Referenced Fields in an Equijoin	1420
Restrictions on Group Fields	1421
Usage Notes for Inner and Outer JOIN Command Syntax	1422
Joining From a Virtual Field to a Real Field Using an Equijoin	1423
Join From a Virtual Field to a Real Field	1423
Notes on Using Virtual Fields With Joined Data Sources	1426
Creating a Virtual Host Field for a Joined Structure	1427
Join Modes in an Equijoin	1428
Control the Join Mode for Record-Based Data Sources	1429
Data Formats of Shared Fields	1429
Joining Fields With Different Numeric Data Types	1430
Enable Joins With Data Type Conversion	1431
Issuing Joins With Data Type Conversion	1431
Using a Conditional Join	1432
Create a Conditional JOIN	1432
Using a Conditional Join	1435
Full Outer Joins	1436
Specify a Full Outer Join	1437
Optimizing a Full Outer Join of Db2 Tables	1442
Reporting Against a Multi-Fact Cluster Synonym	1445
Reporting Against a Multi-Fact Cluster Synonym	1446
Adding a New Fact To Multi-Fact Synonyms: JOIN AS_ROOT	1447
Add an Additional Parent Segment	1447

Generating Outer Joins of Cluster Synonym Contexts	1452
Control Join Processing of Cluster Synonym Contexts	1453
Joining From a Multi-Fact Synonym	1453
Invoking Context Analysis for a Star Schema With a Fan Trap	1457
Navigating Joins Between Cluster Synonyms	1458
Usage Notes for Joins to Cluster Synonyms	1459
Navigating Joins Between Cluster Synonyms	1459
Adding DBA Restrictions to the Join Condition: SET DBAJJOIN	1463
Add DBA Restrictions to the Join Condition	1463
Using the DBAJJOIN Setting With Relational Tables	1464
Preserving Virtual Fields During Join Parsing	1466
Preserving Virtual Fields Using KEEPDEFINES	1466
Use KEEPDEFINES	1467
Usage Notes for KEEPDEFINES	1468
Preserving Virtual Fields During Join Parsing With KEEPDEFINES	1468
Preserving Virtual Fields Using DEFINE FILE SAVE and RETURN	1471
Preserving Virtual Fields With DEFINE FILE SAVE and RETURN	1471
Screening Segments With Conditional JOIN Expressions	1474
Parsing WHERE Criteria in a Join	1474
Displaying Joined Structures	1474
Display a Joined Structure	1475
Displaying a Joined Structure	1475
List Joined Structures	1476
Clearing Joined Structures	1477
Clear a Join	1477
Clearing a Conditional Join	1478
Clearing Joins	1478
Merging Data Sources	1480
Merging Data	1480
Merge Data Sources	1481

Types of MATCH Processing	1482
Controlling MATCH Processing	1483
Usage Notes for Match Requests	1484
Merging Data Sources	1484
Comparing Grouped and Ungrouped Processing	1486
Merge Phrases	1488
Specify Merge Phrases	1489
MATCH Processing With Common High-Order Sort Fields	1491
MATCH Processing With Common High-Order Sort Fields	1492
Merging With a Common High-Order Sort Field	1494
Merging Without a Common High-Order Sort Field	1494
Fine-Tuning MATCH Processing	1495
Using Display Commands in MATCH Processing	1496
Universal Concatenation	1498
Concatenate Data Sources	1499
Concatenating Data Sources	1500
Field Name and Format Matching	1501
Matching Field Names and Formats	1502
Merging Concatenated Data Sources	1503
Merge Concatenated Data Sources	1503
Using Sort Fields in MATCH Requests	1505
Merging Concatenated Data Sources With Common High-Order Sort Fields	1505
Merging Concatenated Data Sources Without a Common Sort Field	1507
Cartesian Product	1508
Enable/Disable Cartesian Product	1509
Usage Notes for Cartesian Product	1509
Reporting With Cartesian Product	1510
Improving Report Processing	1511
Rotating a Data Structure for Enhanced Retrieval	1511
Request an Alternate View	1512

Usage Notes for Restructuring Data	1512
Restructuring Data	1513
Optimizing Retrieval Speed for ibi FOCUS Data Sources	1514
Automatic Indexed Retrieval	1515
Use Indexed Retrieval	1515
Usage Notes for Indexed Retrieval	1515
Using Indexed Retrieval	1516
Data Retrieval Using TABLEF	1517
Printing Using Fast Table Retrieval	1518
Preserving the Internal Matrix of Your Last Report	1518
Save an Internal Matrix	1519
Saving the Internal Matrix of a Report	1519
Compiling Expressions	1520
Compiling Expressions Using the DEFINES Parameter	1520
Usage Notes for Compiled Expressions	1520
Creating Financial Reports With Financial Modeling Language (FML)	1521
Reporting With FML	1521
Sample FML Request	1522
Creating Rows From Data	1525
Retrieve FOR Field Values From a Data Source	1526
Creating Rows From Values in a Data Source	1527
Creating Rows From Multiple Records	1528
Sum Values in Rows With the OR Phrase	1529
Summing Values in Rows	1530
Identify a Range of Values With the TO Phrase	1530
Identifying a Range of Values	1531
Use Masking Characters to Retrieve Tag Values	1531
Using Masking Characters to Match a Group of Tags	1532
Use the Same FOR Field Value in Multiple Rows	1532
Referencing the Same Value in More Than One Row	1533

Using Tags From External Files	1534
Using the BY Phrase in FML Requests	1535
Combining BY and FOR Phrases in an FML Request	1535
Supplying Data Directly in a Request	1536
Supply Data Directly in a Request	1536
Supplying Data Directly in a Request	1537
Performing Inter-Row Calculations	1538
Define Inter-Row Calculations	1538
Usage Notes for RECAP	1539
Referring to Rows in Calculations	1539
Assign an Explicit Row Label	1540
Referring to Default Row Labels in RECAP Expressions	1541
Referring to Columns in Calculations	1543
Referring to Column Numbers in Calculations	1543
Referring to Column Numbers in a RECAP Expression	1543
Referring to Contiguous Columns in Calculations	1545
Recapping Over Contiguous Columns	1545
Referring to Column Addresses in Calculations	1546
Use Column Addressing in a RECAP Expression	1546
Applying Column Addressing in a RECAP Expression	1547
Referring to Relative Column Addresses in Calculations	1547
Applying Relative Column Addressing in a RECAP Expression	1547
Controlling the Creation of Column Reference Numbers	1548
Control the Creation of Column Reference Numbers	1549
Referring to Column Values in Calculations	1549
Referring to a Column by Its Value in a RECAP Expression	1550
Referring to Rows and Columns in Calculations	1551
Styling Multiple RECAP Statements in a Matrix	1551
Referring to Cells in Calculations	1552
Use Cell Notation for Rows and Columns in a RECAP Expression	1552
Referring to Columns Using Cell Notation in a RECAP Expression	1553

Using Functions in RECAP Calculations	1554
Call a Function in a RECAP Command	1554
Calling a Function in a RECAP Command	1555
Inserting Rows of Free Text	1556
Inserting Free Text	1557
Insert Data Variables in Text Rows	1557
Inserting a Data Variable in a Text Row	1558
Adding a Column to an FML Report	1559
Adding a Column to an FML Report	1559
Creating a Recursive Model	1561
Creating a Recursive Model	1562
Reporting Dynamically From a Hierarchy	1563
Requirements for FML Hierarchies	1564
Defining a Hierarchy in a Master File	1565
Displaying an FML Hierarchy	1566
Display an FML Hierarchy	1566
Displaying an FML Hierarchy	1568
Consolidating an FML Hierarchy	1569
Create One Summary Row for an FML Hierarchy	1570
Displaying One Summary Line for an FML Hierarchy	1572
Consolidate FML Hierarchy Data to Any Level and Depth	1573
Consolidating FML Hierarchy Data	1575
Loading a Hierarchy Manually	1578
Load a Hierarchy From One Master File for Use With a Separate Master File	1579
Usage Notes for FML Hierarchies	1581
Customizing a Row Title	1581
Customize a Row Title in FML	1581
Changing the Titles of Tag Rows	1582
Formatting an FML Report	1583
Add an Underline Character for Columns	1584
Underlining Columns	1584

Specify a Page Break in an FML Report	1585
Specifying a Page Break in an FML Report	1585
Format a Row, Column, or Cell in an FML Report	1587
Formatting Rows in an FML Report	1588
Add and Format Row and Cell Borders	1594
Emphasizing a Row Using Uniform Border Lines	1597
Emphasizing a Row Using Different Top/Bottom and Left/Right Borders	1597
Adding Uniform Border Lines Around a Cell	1598
Specify an Indent for an FML Label, Tag, or Caption	1599
Indenting a Tag Row in an FML Hierarchy	1601
Indenting Row Titles in an FML Hierarchy	1602
Indent FML Hierarchy Captions in an HTML Report	1603
Using the Default Indentation for FML Hierarchy Captions	1604
Specifying an Indentation Value for FML Hierarchy Captions	1605
Suppressing the Display of Rows	1606
Suppressing the Display of a TAG Row	1606
Suppressing Rows With No Data	1607
Suppressing Rows With No Data	1607
Saving and Retrieving Intermediate Report Results	1608
Posting Data	1608
Post Data to a File	1609
Posting Rows to a Work File	1609
Pick Up Data From a Work File	1610
Picking Up Data From a Work File	1611
Creating HOLD Files From FML Reports	1612
Creating a Hold File From an FML Report	1613
Creating a Free-Form Report	1615
Creating a Free-Form Report	1615
Creating a Free-Form Report	1616
Request for EMPLOYEE EDUCATION HOURS REPORT	1618
Designing a Free-Form Report	1620

Incorporating Text in a Free-Form Report	1620
Incorporating Data Fields in a Free-Form Report	1621
Incorporating Graphic Characters in a Free-Form Report	1622
Laying Out a Free-Form Report	1622
Sorting and Selecting Records in a Free-Form Report	1623
Creating Graphs: GRAPH	1624
Introduction	1624
GRAPH vs. TABLE Requests	1625
Running Graph Requests Offline	1631
Run a Graph Request Offline	1631
Controlling the Format	1632
Graphic Devices Supported	1635
Medium-Resolution Devices	1636
High-Resolution Devices	1636
Command Syntax	1637
GRAPH vs. TABLE Syntax	1637
Specifying Graph Forms and Contents	1639
Naming Subjects: Verb Phrases	1639
Selecting Forms: BY and ACROSS Phrases	1640
Selecting the Contents: Selection Phrases	1641
Concatenating Unlike Data Sources	1642
Adding Annotating Text: HEADING and FOOTING Lines	1644
Inserting Formatting Controls	1644
Inserting Field References	1645
Graph Forms	1646
Connected Point Plots	1647
Point Plot Features	1648
Histograms	1651
Histogram Features	1653
Bar Charts	1654

Bar Chart Features	1655
Pie Charts	1658
Pie Chart Features	1659
Scatter Diagrams	1659
Scatter Diagram Features	1661
Adjusting Graph Elements	1662
The Horizontal Axis: System Defaults	1665
Set the Width	1666
Set the Scale: Assigning Fixed Limits	1666
Set Class and Tick Intervals	1667
The Vertical Axis: System Defaults	1668
Set the Height	1669
Set the Scale: Assigning Fixed Limits	1669
Set Class and Tick Intervals	1670
Highlighting Facilities	1671
Add Horizontal or Vertical Grids	1671
Add Summary Numbers in Pie and Bar Charts	1672
Add Trend Lines on Scatter Plots	1672
Special Topics	1672
Plotting Dates	1673
Handling Missing Data	1674
Using Fixed-Axis Scales	1677
Saving Formatted GRAPH Output	1678
Display Stored Graphs	1679
Creating Formatted Input for CA-TELLAGRAF	1680
Using the FOCUS ICU Interface	1680
Special Graphics Devices	1681
Medium-Resolution Devices	1682
High-Resolution Devices	1682
IBM Devices Using GDDM	1682
GDDM Default Conditions	1682

GDDM Save and Print Facilities	1683
Graphics Device Characteristics	1683
Hewlett-Packard Plotters	1683
Tektronix Color Terminals	1684
Command and SET Parameter Summary	1685
GRAPH Command	1685
Enter the Environment	1685
Specify Annotating Text	1685
Name the Subject and Graph Type	1686
Specify Display Fields	1686
Specify Horizontal Sorting of Data Points	1687
Specify Separate Graphs or Vertical Sorting of Plot Points	1687
Save the Formatted Graph Data in a File	1687
Complete the GRAPH Request	1687
Concatenate Unlike Data Sources	1688
SET Parameters	1688
Using SQL to Create Reports	1698
Supported and Unsupported SQL Statements	1698
Supported SQL Statements	1698
Unsupported SQL Statements	1700
SQL Translator Reserved Words	1700
Using SQL Translator Commands	1701
Use SQL Translator Commands	1701
Using SQL Translator Commands	1702
TABLE Formatting Phrases in SQL Requests	1703
The SQL SELECT Statement	1703
Using the SQL SELECT Statement Without a FROM Clause	1704
SQL Joins	1705
Create an Inner Join	1705
Create an Outer Join	1706

Join Name Assignments From the SQL Translator	1707
Using Qualified Field Names in SQL Joins	1708
Using Recursive SQL Joins	1708
Using SQL Full Outer Joins	1708
SQL Join Considerations	1709
SQL CREATE TABLE and INSERT INTO Commands	1709
Usage Notes for CREATE TABLE and INSERT INTO Commands	1710
Creating a Table With Single-Record Insert	1710
Inserting Values Expressed With an Exponent	1710
SQL CREATE VIEW and DROP VIEW Commands	1711
Create a View	1711
Creating and Reporting From an SQL View	1712
Dropping an SQL View	1712
SQL PREPARE, EXECUTE, and COMMIT Commands	1713
Executing an SQL SELECT Statement Using an Identifier	1713
Cartesian Product Style Answer Sets	1714
Continental Decimal Notation (CDN)	1714
Using CDN to Separate Digits	1714
Specifying Field Names in SQL Requests	1714
Specifying a Field Name With a Delimited Identifier	1715
Qualifying a Delimited Field Name	1715
SQL UNION, INTERSECT, and EXCEPT Operators	1715
Numeric Constants, Literals, Expressions, and Functions	1716
SQL Translator Support for Date, Time, and Timestamp Fields	1716
SQL Translator Support for Date, Time, and Timestamp Fields	1716
Extracting Date-Time Components Using the SQL Translator	1718
Use Date, Time, and Timestamp Functions Accepted by the SQL Translator	1718
Using SQL Translator Date, Time, and Timestamp Functions	1719
Using SQL Translator Date, Time, and Timestamp Functions in a SELECT Statement	1720
Use the SQL Translator EXTRACT Function to Extract Date-Time Components ...	1721

Using the EXTRACT Function	1722
Index Optimized Retrieval	1722
Optimized Joins	1722
TABLEF Optimization	1723
Improve Performance Using SQLTOPTTF	1723
SQL INSERT, UPDATE, and DELETE Commands	1724
Master Files and Diagrams	1726
EMPLOYEE Data Source	1726
EMPLOYEE Master File	1727
EMPLOYEE Structure Diagram	1728
JOBFILE Data Source	1729
JOBFILE Master File	1729
JOBFILE Structure Diagram	1729
EDUCFILE Data Source	1730
EDUCFILE Master File	1730
EDUCFILE Structure Diagram	1731
SALES Data Source	1731
SALES Master File	1732
SALES Structure Diagram	1732
CAR Data Source	1733
CAR Master File	1734
CAR Structure Diagram	1735
LEDGER Data Source	1735
LEDGER Master File	1736
LEDGER Structure Diagram	1736
FINANCE Data Source	1736
FINANCE Master File	1736
FINANCE Structure Diagram	1737
REGION Data Source	1737
REGION Master File	1737

REGION Structure Diagram	1738
EMPDATA Data Source	1738
EMPDATA Master File	1738
EMPDATA Structure Diagram	1739
TRAINING Data Source	1739
TRAINING Master File	1739
TRAINING Structure Diagram	1740
COURSE Data Source	1740
COURSE Master File	1740
COURSE Structure Diagram	1741
JOBHIST Data Source	1741
JOBHIST Master File	1741
JOBHIST Structure Diagram	1741
JOBLIST Data Source	1742
JOBLIST Master File	1742
JOBLIST Structure Diagram	1742
LOCATOR Data Source	1743
LOCATOR Master File	1743
LOCATOR Structure Diagram	1743
PERSINFO Data Source	1744
PERSINFO Master File	1744
PERSINFO Structure Diagram	1744
SALHIST Data Source	1745
SALHIST Master File	1745
SALHIST Structure Diagram	1745
VIDEOTRK, MOVIES, and ITEMS Data Sources	1746
VIDEOTRK Master File	1746
VIDEOTRK Structure Diagram	1746
MOVIES Master File	1747
MOVIES Structure Diagram	1748
ITEMS Master File	1748

ITEMS Structure Diagram	1749
VIDEOTR2 Data Source	1749
VIDEOTR2 Master File	1749
VIDEOTR2 Structure Diagram	1750
Gotham Grinds Data Sources	1751
GGDEMOG Master File	1751
GGDEMOG Structure Diagram	1752
GGORDER Master File	1753
GGORDER Structure Diagram	1753
GGPRODS Master File	1754
GGPRODS Structure Diagram	1754
GGSALES Master File	1755
GGSALES Structure Diagram	1755
GGSTORES Master File	1756
GGSTORES Structure Diagram	1756
Century Corp Data Sources	1757
CENTCOMP Master File	1758
CENTCOMP Structure Diagram	1758
CENTFIN Master File	1759
CENTFIN Structure Diagram	1759
CENTHR Master File	1760
CENTHR Structure Diagram	1762
CENTINV Master File	1763
CENTINV Structure Diagram	1763
CENTORD Master File	1764
CENTORD Structure Diagram	1765
CENTQA Master File	1766
CENTQA Structure Diagram	1767
CENTGL Master File	1768
CENTGL Structure Diagram	1768
CENTSYSF Master File	1769

CENTSYSF Structure Diagram	1769
CENTSTMT Master File	1769
CENTSTMT Structure Diagram	1770
CENTGLL Master File	1771
CENTGLL Structure Diagram	1771
Error Messages	1773
Displaying Messages	1773
Table Syntax Summary and Limits	1774
TABLE Syntax Summary	1774
Hierarchical Reporting Syntax Summary	1776
TABLEF Syntax Summary	1776
MATCH Syntax Summary	1778
FOR Syntax Summary	1779
TABLE Limits	1780
Writing User-Coded Programs to Create HOLD Files	1782
Arguments Used in Calls to Programs That Create HOLD Files	1782
Sample User-Coded Program That Creates a HOLD File	1783
ibi Documentation and Support Services	1785
Legal and Third-Party Notices	1786

Creating Tabular Reports

The FOCUS reporting language is a powerful tool for analyzing and formatting information. The language is non-procedural—that is, you only need to think about what information you want to present in your report. For the most part, you can describe the report in any order; the sequence of commands is not important.

The simplest form of report that you can produce is a tabular report, a report whose information is arranged vertically in columns. This is the basic report format, incorporating the fundamental reporting concepts and command syntax. Most of the other report formats build on these concepts and syntax.

Requirements for Creating a Report

To create a report, only two things are required:

- **Data.** You need data from which to report. If the data is protected by an underlying security system, you may need permission to report from the data source. In addition, FOCUS must be able to locate the data source.

You can report from many different types of data sources (with variations for different operating environments), including the following:

- Relational data sources, such as DB2, Teradata, and Oracle, and Sybase.
- Hierarchical data sources, such as IMS and FOCUS.
- Indexed data sources, such as ISAM and VSAM.
- Network data sources, such as CA-IDMS.
- Sequential data sources, both fixed-format and delimited format.

For a complete list, see your *Describing Data* manual.

- **A data description.** You need a Master File, which describes the data source from which you are reporting. The Master File is a map of the segments in the data source and all of the fields in each segment. For some types of data sources, the Master File is supplemented by an Access File. See the *Describing Data* manual for information on Master Files and Access Files.

By looking at the Master File, you can determine what fields are in the data source, what they are named, and how they are formatted. You can also determine how the segments in the data source relate to each other. Although you can create a very simple report without this information, knowing the structure of the data source enables you to generate creative and sophisticated reports.

You can supplement the information in the Master File by generating a picture of the data source structure, which shows how the data source segments relate to each other. Use the following command:

```
CHECK FILE filename PICTURE RETRIEVE
```

In the picture, segments are shown in the order in which they are retrieved. Four fields of each segment are displayed. For details, see Chapter 2, *Displaying Report Data*.

Creating a Report Request

You can use any text editor to create your report request. Using the text editor, you can create ad hoc reports or create a report and save it as a stored procedure, enabling you to edit the request at any time. Stored procedures are described in more detail in the *Developing Applications* manual.

Beginning a Report Request

A report request begins with the TABLE FILE command and ends with the END command. The commands and phrases between the beginning and end of a request define the contents and format of a report. These parts of the request are optional; you only need to include the commands and phrases that produce the report functions you want. For example, if you want your report to be sorted, you need only include a sorting phrase.

Begin a Report Request

To begin a report request, use the command

```
TABLE FILE filename
```

where:

filename

Specifies a data source for the report.

Issuing Report Requests

The following examples produce the same report:

1. TABLE FILE EMPLOYEE PRINT LAST_NAME BY DEPARTMENT
END
2. TABLE FILE EMPLOYEE
PRINT LAST_NAME
BY DEPARTMENT
END
3. TABLE
FILE EMPLOYEE
PRINT
LAST_NAME BY DEPARTMENT
END

The output is:

DEPARTMENT	LAST_NAME
-----	-----
MIS	SMITH
	JONES
	MCCOY
	BLACKWOOD
	GREENSPAN
	CROSS
PRODUCTION	STEVENS
	SMITH
	BANNING
	IRVING
	ROMANS
	MCKNIGHT

Reporting With a Default Data Source

An alternate way to specify the file name is with the SET FILE command. SET FILE establishes a default data source for all requests, as described in the *Developing Applications* manual. The following sets the EMPLOYEE data source as the default:

```
SET FILE = EMPLOYEE

TABLE
PRINT CURR_SAL
BY DEPARTMENT
END
```

This alternative is useful when you wish to enter several report requests against the same data source. Of course, you can still issue requests against other data sources simply by specifying the file name in the request instead of relying upon the default name.

Requesting Help When Issuing a Report Request

If you issue report requests interactively at the command prompt rather than from a procedure, online error correction is provided with help text after you issue the END command. For example, if you enter

```
TABLE FI EMPLOYEE
PRINT LAST_NAME FIRST_NAME
BY DEPARTMENT
END
```

at the command prompt, the following error message displays:

```
(FOC001) THE NAME OF THE FILE OR THE WORD 'FILE' IS MISSING
```

However, if the information provided by the error message is not sufficient, issue

```
? errornumber
```

for a more detailed explanation of the error.

Every command you enter is scanned, and a report is generated immediately after you enter the END command.

When the value of the MESSAGE parameter is ON (the default value), the number of records retrieved from the data source and the number of lines displayed in the report displays at the beginning of each report.

Completing a Report Request

To complete a report request, use the END or RUN command. These commands must be typed on a line by themselves. To discontinue a report request without executing it, enter the QUIT command.

If you plan to issue consecutive report requests against different data sources during one session, use the END command.

You also have the option of using the RUN command to complete a report request. The RUN command keeps the TABLE facility and the data source active for the duration of the TABLE session. This is useful since you do not need to repeat the TABLE command to produce another report using the same data source.

Selecting a Report Output Destination

Once you generate a report, you still need to display it. The following facilities are available for displaying your report:

- **On a screen.** The HotScreen facility enables you to search for report data, save parts of the report to a file, and customize how your report scrolls on the screen. Unless you specify otherwise, your reports automatically display on the screen using the HotScreen facility.
- **On paper.** When you print your reports on paper, you can control how reports that are too wide to fit on a single page are arranged on the supplementary pages so that the context of the data is clear.

Of course, you can easily direct the same report to both the screen and the printer by switching display modes and using the RETYPE command. Or you can choose not to display your report at all, and instead store the results as a data source using the HOLD, SAVE, or SAVB command. For details, see [Saving and Reusing Your Report Output](#).

Developing Your Report Request

The only requirement for reporting is identifying a data source. Beyond that, the structure of a report request is very flexible; that is, you only need to include the report elements you want. For example, you only need to include sorting instructions if you want your report to be sorted, or selection criteria if you want to report on a subset of your data.

A report request begins with the TABLE FILE command and ends with the END command. The commands and phrases between the beginning and end of a request define the contents and format of a report. These parts of the request are optional; you only need to include the commands and phrases that produce the report functions you want.

The following are the most frequently used options for structuring a report request.

- **Specifying fields and columns.** Each column in your report represents a field. You can specify which fields you want to display, which fields you want to use to sort the report, which fields you want to use to select records, and which data source fields you want to use in creating temporary fields. Therefore, specifying the fields you want in a report is fundamentally tied to how you want to use those fields in your report.
- **Displaying data.** You can display data in your report by listing all the records for a field (detailed presentation), or by totaling the records for a field (summary presentation). You can also perform calculations and other operations on fields, such as finding the highest value of a field or calculating the average sum of squares of all the values of a field, and present the results of the operation in your report.
- **Sorting a report column.** Sorting a report enables you to organize a column's information. FOCUS displays the sort field (the field that controls the sorting order) at the left of the report if you are sorting vertically or at the top if you are sorting horizontally. Sort fields are displayed when their values change. You can also choose not to display sort fields.

You can sort information vertically, down a column, horizontally, across a row; you can also combine vertical sorting and horizontal sorting to create a simple matrix.

- **Selecting records.** When you generate a report, you may not want to include every record. Selecting records enables you to define a subset of the data source based on your criteria and then report on that subset. Your selection criteria can be as simple or complex as you wish.
- **Showing subtotals and totals.** You can display column and row totals, grand totals, and section subtotals in your report.

- **Customizing the presentation.** There are two aspects of a successful report: the information you present, and how it is presented. A report that identifies related groups of information and draws attention to important facts is more effective than one that simply shows columns of data. For example, you can:
 - Give column titles more meaningful names.
 - Control the display of columns in your report.
 - Create headings and footings for different levels of the report, including each sort group, each page, and the entire report, and dynamically control the display of headings and footings based on conditions you set.
 - Add fonts, colors, grids, and images in a styled report.
 - Highlight a group of related information and separate it from other groups by inserting blank lines, underlines, and page breaks.
- **Creating temporary fields.** When you create a report, you are not limited to the fields that already exist in the data source. You can create temporary fields, deriving their values from real data source fields, and include them in your report. For details, see [Creating Temporary Fields](#).
- **Joining data sources.** You can join two or more data sources to create a larger integrated data structure, from which you can report in a single request. For details, see [Joining Data Sources](#).
- **Storing and reusing the results.** You can store your report data as a data source against which you can make additional queries. This is especially helpful for creating a subset of your data source and for generating two-step reports. You can also format the new data source for use by other data processing tools such as spreadsheets and word processors. For details, see [Saving and Reusing Your Report Output](#).

You can run the request as an ad hoc query or save it as a procedure. Saving a report request as a procedure enables you to run or edit it at any time.

Developing a Report Request

The following report incorporates many customization features, such as renaming column titles, creating headings and footings for sections of the report, and dynamically controlling the display of headings and footings.

```

TABLE FILE EMPLOYEE
HEADING CENTER
"Departmental Salary Report </1"
PRINT CURR_JOBCODE AS 'Job Code'
BY DEPARTMENT AS 'Department'
BY LAST_NAME AS 'Last Name'
BY CURR_SAL AS 'Current,Salary'
ON CURR_SAL SUBFOOT
"<13 *** WARNING: <LAST_NAME 's salary exceeds recommended guidelines."
WHEN CURR_SAL GT 27000;
ON DEPARTMENT SUBFOOT
"<13 Total salary expense for the <DEP dept is: <ST.CURR_SAL"
ON DEPARTMENT SKIP-LINE
END

```

The output is:

PAGE 1

Departmental Salary Report

Department	Last Name	Current Salary	Job Code
-----	-----	-----	-----
MIS	BLACKWOOD	\$21,780.00	B04
	CROSS	\$27,062.00	A17
	*** WARNING: CROSS 's salary exceeds recommended guidelines.		
	GREENSPAN	\$9,000.00	A07
	JONES	\$18,480.00	B03
	MCCOY	\$18,480.00	B02
	SMITH	\$13,200.00	B14
	Total salary expense for the MIS dept is:		

```

$108,002.00
      PRODUCTION  BANNING                $29,700.00  A17
      *** WARNING: BANNING 's salary exceeds recommended
guidelines.
      IRVING                $26,862.00  A15
      MCKNIGHT             $16,100.00  B02
      ROMANS                $21,120.00  B04
      SMITH                 $9,500.00   A01
      STEVENS              $11,000.00  A07
      Total salary expense for the PRODUCTION dept is:
$114,282.00

```

Including Display Fields in a Report Request

The maximum number of display fields you can include in a report request is approximately 1024 (495 for MATCH requests). However, when adding fields to a request, it is important to be aware that the allowable number of fields includes all named fields, whether printed or not. These include data source fields, temporary fields (virtual fields and calculated values), certain internal fields (for example, TABPAGENO), and fields used in headings and footings. The total does not include sort fields.

This field limit is also affected by the combined length of fields in the request: that is, the field limit represents the maximum number of fields allowed when each field has the smallest length possible (A4 ACTUAL). Longer field lengths reduce the total number of printable fields.

When you create a report, the fields specified in the request are stored in a 64K (3956 bytes for MATCH requests) data area. The capacity of the data area is affected by a number of factors:

- Every field is rounded up to a full word boundary (a multiple of 4).
- Every field is associated with a four-byte counter field, which affects the total number of bytes in this data area.
- Field prefixes and formatting options impact the available data area.

If the combined length of the display fields in the data area exceeds the maximum capacity, an error message displays. To correct the problem, adjust the number or lengths of the fields in the request. The total length of fields in the report output is limited to 32K.

Referring to Fields in a Report Request

When creating a report, you refer to fields in several parts of the request—for example, in display commands (PRINT, SUM), in sort phrases (BY, ACROSS), and in selection criteria (WHERE, WHERE TOTAL, IF).

Several methods are available for referring to a field. You can:

- Refer to individual fields by using the alias specified in the Master File, referring to the name defined in the Master File, or using the shortest unique truncation of the field name or alias. For details, see [Referring to an Individual Field](#).
- Refer to fields using qualified field names. For details, see [Referring to Fields Using Qualified Field Names](#).
- Refer to all fields in a segment using only one field name. For details, see [Referring to All of the Fields in a Segment](#).

You can also view a list of all the fields that are included in a data source, or a specified Master File. For details, see [Displaying a List of Field Names](#) and [Listing Field Names, Aliases, and Format Information](#).

Referring to an Individual Field

You can refer to an individual field in any one of the following ways:

- Using the field name defined in the Master File.
- Using the alias (the field name's synonym) defined in the Master File.
- Using the shortest unique truncation of the field name or the alias. When a truncation is used, it must be unique; if it is not unique, an error message is displayed.
- Adding the letter S to the end of the field name defined in the Master File.

Referring to an Individual Field

In the following requests, DEPARTMENT is the complete field name, DPT is the alias, and DEP is a unique truncation of DEPARTMENT. All these examples produce the same output.

1. TABLE FILE EMPLOYEE
PRINT DEPARTMENT
END
2. TABLE FILE EMPLOYEE
PRINT DPT
END
3. TABLE FILE EMPLOYEE
PRINT DEP
END

i Note: If you use a truncation that is not unique, the following message appears:

```
(FOC016) THE TRUNCATED FIELDNAME IS NOT UNIQUE : D
```

Referring to Fields Using Qualified Field Names

In a request, you can qualify field names with the Master File name and/or the segment name. Field names are always displayed as column titles in reports, unless a TITLE attribute or an AS phrase is used to provide an alternative name. For related information, see [Customizing Tabular Reports](#).

You may use the file name, segment name, or both as a qualifier for a specified field. This is useful when structures contain duplicate field names. All referenced field names and aliases may be qualified.

Using a Qualified Field Name to Refer to a Field

```
EMPLOYEE.EMPINFO.EMP_ID
```

Is the fully qualified name of the field EMP_ID in the EMPINFO segment of the EMPLOYEE file.

Referring to All of the Fields in a Segment

If you want to generate a report that displays all of a segment's fields, you can refer to the complete segment without specifying every field. You only need to specify one field in the segment-any field will do-prefixed with the SEG. operator.

Referring to All Fields in a Segment

The segment PRODS01 in the GGPRODS Master File contains the PRODUCT_ID, PRODUCT_DESCRIPTION, VENDOR_CODE, VENDOR_NAME, PACKAGE_TYPE, SIZE, and UNIT_PRICE fields.

```
SEGMENT=PRODS01  
FIELDNAME = PRODUCT_ID  
FIELDNAME = PRODUCT_DESCRIPTION  
FIELDNAME = VENDOR_CODE  
FIELDNAME = VENDOR_NAME  
FIELDNAME = PACKAGE_TYPE  
FIELDNAME = SIZE  
FIELDNAME = UNIT_PRICE
```

To write a report that includes data from every field in the segment, you can issue either of the following requests:

1. TABLE FILE GGPRODS
PRINT PRODUCT_ID AND PRODUCT_DESCRIPTION AND VENDOR_CODE AND
VENDOR_NAME AND PACKAGE_TYPE AND SIZE AND UNIT_PRICE
END
2. TABLE FILE GGPRODS
PRINT SEG.PRODUCT_ID
END

Displaying a List of Field Names

If you want to see a list of all the fields that are included in a data source, you can issue the ?F field name query.

This is useful if you need to refer to a list of field names, or check the spelling of a field name. It also shows you the entire field name. More information on all of the query (?) commands appears in the *Developing Applications* manual.

Listing Field Names, Aliases, and Format Information

The ?FF query displays field name, alias, and format information for a specified Master File, grouped by segment. Like the ?F query, you may issue ?FF:

- From the command line.
- When entering a TABLE, MATCH, MODIFY, SCAN, or GRAPH request online. However, with a TABLE or MATCH request you will not see the list until after you issue the END command.

i Note:

- If duplicate field names match a specified string, the display includes the field name qualified by the segment name with both ?F and ?FF.
- Field names longer than 31 characters are truncated in the display, and a caret (>) is appended in the 32nd position to indicate that the field name is longer than the display.
- When issuing a request in the Terminal Operator Environment, the ?F query activates the Fields window. However, ?FF makes the Output window active.

Displaying Report Data

Reporting, at the simplest level, retrieves field values from a data source and displays those values. There are three ways to do this:

- List each field value (PRINT and LIST commands).
- Add all the values and display the sum (SUM command).
- Count all the values and display the quantity (COUNT command).

Using Display Commands in a Request

The four display commands (PRINT, LIST, SUM, and COUNT) are also known as verbs. These commands are flexible; you can report from several fields using a single command, and include several different display commands in a single report request.

Use Display Commands in a Request

```
display [THE] [SEG.]fieldname1 [AND] [THE] fieldname2 ...
```

or

```
display *
```

where:

display

Is the PRINT, LIST, SUM, or COUNT command. WRITE and ADD are synonyms of SUM and can be substituted for it.

SEG.

Displays all fields in a segment (a group of related fields in a Master File). The field name you specify can be any field in the segment.

fieldname

Is the name of the field to be displayed in the report.

The maximum number of display fields your report can contain is determined by a combination of factors. For details, see [Maximum Number of Display Fields Supported in a Request](#).

The fields appear in the report in the same order in which they are specified in the report request. For example, the report column for *fieldname1* appears first, followed by the report column for *fieldname2*.

The field to be displayed is also known as the display field.

AND

Is optional and is used to enhance readability. It can be used between any two field names, and does not affect the report.

THE

Is optional and is used to enhance readability. It can be used before any field name, and does not affect the report.

*

Applies the display command to every field in the left path of the data source.

i Note: The SEG. and * options do not display virtual fields. To print virtual fields, explicitly reference them in the PRINT statement (PRINT * virtual field name). This is true even if the virtual field name redefines a real field.

Displaying Individual Values

The display commands LIST and PRINT list the individual values of the fields you specify in your report request. LIST numbers the items in the report. PRINT does not number the items.

You can easily display all of the fields in the data source by specifying an asterisk (*) wildcard instead of a specific field name, as described in [Displaying Individual Values](#).

For all PRINT and LIST requests, the number of records retrieved and the number of lines displayed are the same. In addition, there is no order to the report rows. The PRINT and LIST commands display all the values of the selected fields found in the data source in the order in which they are accessed. The order in which data is displayed may be affected by the AUTOPATH setting. For more information, see [Optimizing Retrieval Speed for FOCUS Data Sources](#), and the documentation on SET parameters in the *ibi™ FOCUS® Developing Applications* manual.

In general, when using PRINT or LIST, the order of the values displayed in the report depends on whether or not the field is a key field, as described in the *ibi™ FOCUS® Describing Data* manual.

Alternatively, you can sort the values using the BY or ACROSS sort phrases. When LIST is used in a request that includes a sort phrase, the list counter is reset to 1 every time the value in the outermost sort field changes. For more information on sorting, see [Sorting Tabular Reports](#).

PRINT * or PRINT SEG.* prints only the real fields in the Master File. To print virtual fields, explicitly reference them in the PRINT statement (PRINT * virtual field name). This is true even if the virtual field name is a re-defines of a real field.

For PRINT and LIST syntax, see [Using Display Commands in a Request](#).

Displaying Individual Field Values

To display the values of individual fields, use the PRINT command. The following request displays the values of two fields, LAST_NAME and FIRST_NAME, for all employees.

```
TABLE FILE EMPLOYEE
PRINT LAST_NAME AND FIRST_NAME
END
```

The following shows the report output.

LAST_NAME	FIRST_NAME
STEVENS	ALFRED

LAST_NAME	FIRST_NAME
SMITH	MARY
JONES	DIANE
SMITH	RICHARD
BANNING	JOHN
IRVING	JOAN
ROMANS	ANTHONY
MCCOY	JOHN
BLACKWOOD	ROSEMARIE
MCKNIGHT	ROGER
GREENSPAN	MARY
CROSS	BARBARA

Listing Records

To number the records in a report, use the LIST command.

```
TABLE FILE EMPLOYEE  
LIST LAST_NAME AND FIRST_NAME  
END
```

The following shows the report output.

LIST	LAST_NAME	FIRST_NAME
1	STEVENS	ALFRED
2		
3	SMITH	MARY
4		
5	JONES	DIANE
6		
7	SMITH	RICHARD
8		
9	BANNING	JOHN
10		
11	IRVING	JOAN
12		
	ROMANS	ANTHONY
	MCCOY	JOHN
	BLACKWOOD	ROSEMARIE
	MCKNIGHT	ROGER
	GREENSPAN	MARY
	CROSS	BARBARA

Displaying All Fields

You can easily display all of the fields in the left path of the data source by specifying an asterisk (*) wildcard instead of a specific field name. For additional information about Master File structures and segment paths, including left paths and short paths, see the *ibi™ FOCUS® Describing Data* manual.

Displaying All Fields

The following request produces a report displaying all of the fields in the EDUCFILE data source.

```
TABLE FILE EDUCFILE
LIST *
END
```

The following shows the report output.

LIST	COURSE_CODE	COURSE_NAME	DATE_ATTEND	EMP_ID
----	-----	-----	-----	-----
1	101	FILE DESCRPT & MAINT	83/01/04	
212289111				
2	101	FILE DESCRPT & MAINT	82/05/25	
117593129				
3	101	FILE DESCRPT & MAINT	82/05/25	
071382660				
4	101	FILE DESCRPT & MAINT	81/11/15	
451123478				
5	101	FILE DESCRPT & MAINT	81/11/15	
112847612				
6	102	BASIC REPORT PREP NON-PROG	82/07/12	
326179357				
7	103	BASIC REPORT PREP FOR PROG	83/01/05	
212289111				
8	103	BASIC REPORT PREP FOR PROG	82/05/26	
117593129				
9	103	BASIC REPORT PREP FOR PROG	81/11/16	
112847612				
10	104	FILE DESC & MAINT NON-PROG	82/07/14	
326179357				
11	106	TIMESHARING WORKSHOP	82/07/15	
326179357				
12	202	WHAT'S NEW IN FOCUS	82/10/28	
326179357				
13	301	DECISION SUPPORT WORKSHOP	82/09/03	
326179357				
14	107	BASIC REPORT PREP DP MGRS	82/08/02	
818692173				
15	302	HOST LANGUAGE INTERFACE	82/10/21	
818692173				
16	108	BASIC RPT NON-DP MGRS	82/10/10	
315548712				
17	108	BASIC RPT NON-DP MGRS	82/08/24	
119265415				
18	201	ADVANCED TECHNIQUES	82/07/26	
117593129				
19	203	FOCUS INTERNALS	82/10/28	
117593129				

Displaying All Fields in a Segment

You can easily display all fields in a segment by adding the prefix "SEG." to any field in the desired segment.

Display All Fields in a Segment

```
seg.anyfield
```

where:

anyfield

Is any field that is in the desired segment.

Displaying All Fields in a Segment

The following request produces a report displaying all of the fields in the segment that contains the QTY_IN_STOCK field.

```
TABLE FILE CENTINV
PRINT SEG.QTY_IN_STOCK
BY PRODNAME NOPRINT
END
```

The following shows the report output.

Product Number:	Product Name:	Quantity In Stock:	Price:	Our Cost:
-----	-----	-----	-----	-----
-				
1028	AR2 35MM Camera 8 X	11499	109.00	79.00
1026	AR3 35MM Camera 10 X	12444	129.00	95.00
1006	Combo Player - 4 Hd VCR + DVD	13527	399.00	289.00

1008	DVD Upgrade Unit for Cent. VCR	199	199.00
139.00			
1030	QX Portable CD Player	22000	169.00
99.00			
1032	R5 Micro Digital Tape Recorder	1990	89.00
69.00			
1036	ZC Digital PDA - Standard	33000	299.00
249.00			
1034	ZT Digital PDA - Commercial	21000	499.00
349.00			
1024	110 VHS-C Camcorder 20 X	4000	349.00
249.00			
1022	120 VHS-C Camcorder 40 X	2300	399.00
259.00			
1020	150 8MM Camcorder 20 X	5961	319.00
240.00			
1004	2 Hd VCR LCD Menu	43068	179.00
129.00			
1018	250 8MM Camcorder 40 X	60073	399.00
320.00			
1016	330DX Digital Camera 1024K P	12707	279.00
199.00			
1014	340SX Digital Camera 65K P	990	249.00
199.00			
1012	650DL Digital Camcorder 150 X	2972	899.00
710.00			
1010	750SL Digital Camcorder 300 X	10758	999.00
750.00			

<u>Product Number:</u>	<u>Product Name:</u>	<u>Quantity In Stock:</u>	<u>Price:</u>	<u>Our Cost:</u>
1024	110 VHS-C Camcorder 20 X	4000	349.00	249.00
1022	120 VHS-C Camcorder 40 X	2300	399.00	259.00
1020	150 8MM Camcorder 20 X	5961	319.00	240.00
1004	2 Hd VCR LCD Menu	43068	179.00	129.00
1018	250 8MM Camcorder 40 X	60073	399.00	320.00
1016	330DX Digital Camera 1024K P	12707	279.00	199.00
1014	340SX Digital Camera 65K P	990	249.00	199.00
1012	650DL Digital Camcorder 150 X	2972	899.00	710.00
1010	750SL Digital Camcorder 300 X	10758	999.00	750.00
1028	AR2 35MM Camera 8 X	11499	109.00	79.00
1026	AR3 35MM Camera 10 X	12444	129.00	95.00
1006	Combo Player - 4 Hd VCR + DVD	13527	399.00	289.00
1008	DVD Upgrade Unit for Cent. VCR	199	199.00	139.00
1030	QX Portable CD Player	22000	169.00	99.00
1032	R5 Micro Digital Tape Recorder	1990	89.00	69.00
1036	ZC Digital PDA - Standard	33000	299.00	249.00
1034	ZT Digital PDA - Commercial	21000	499.00	349.00

Displaying the Structure and Retrieval Order of a Multi-Path Data Source

When using display commands, it is important to understand the structure of the data source and the relationship between segments, since these factors affect your results. You can use the CHECK command PICTURE option to display a diagram of the data source structure defined by the Master File.

You can also display the retrieval order of a data source using the CHECK command PICTURE RETRIEVE option. It should be noted that retrieval is controlled by the minimum referenced subtree. For more information, see *Understanding the Efficiency of the Minimum Referenced Subtree* in the *Describing a Group of Fields* chapter in the *ibi™ FOCUS® Describing Data* manual.

Displaying the Retrieval Order of a Multi-Path Data Source

To display the retrieval order of the EMPLOYEE data source, which is joined to the JOBFIL and EDUCFILE data sources, issue the following command:

```
CHECK FILE EMPLOYEE PICTURE RETRIEVE
```

The following shows the command output that adds the numbers that display at the top left of each segment, indicating the retrieval order of the segments. A unique segment such as FUNDTRAN is treated as a logical addition to the parent segment for retrieval. FUNDTRAN and SECSEG are unique segments, and are therefore treated as part of their parents.

The following shows the retrieval order:

```

check file employee picture retrieve
NUMBER OF ERRORS=          0
NUMBER OF SEGMENTS= 11 ( REAL= 6 VIRTUAL= 5 )
NUMBER OF FIELDS=  34 INDEXES= 0 FILES=  3
TOTAL LENGTH OF ALL FIELDS= 365
SECTION 01
      RETRIEVAL VIEW OF FOCUS   FILE EMPLOYEE ON 12/29/93 AT 14.42.18

      EMPINFO
01      S1
*****
*EMP_ID **
*LAST_NAME **
*FIRST_NAME **
*HIRE_DATE **
*
*****
      I
      I
      I
      I FUNDTRAN
02      I U
*****
*BANK_NAME *
*BANK_CODE *
*BANK_ACCT *
*EFFECT_DATE *
*
*****
      I
      I
      I
      I PAYINFO          I ADDRESS          I SALINFO          I ATTNDEG
03      I SH1          07      I S1          08      I SH1          10      I KM
*****
*DATE_INC ** *TYPE ** *PAY_DATE ** *DATE_ATTEND **
*PCT_INC ** *ADDRESS_LM1 ** *GROSS ** *EMP_ID **K
*SALARY ** *ADDRESS_LM2 ** * ** * **
*JOBCODE ** *ADDRESS_LM3 ** * ** * **
* ** * ** * ** *
*****
      I          I          I          I EDUCFILE
      I          I          I          I
      I          I          I          I
      I JOBSEG          I DEDUCT          I COURSEG
04      I KU          09      I S1          11      I KLU
*****
:JOBCODE :K          *DED_CODE ** *COURSE_CODE :
:JOB_DESC :          *DED_AMT ** *COURSE_NAME :
:          :          * ** :
:          :          * ** :
:          :          * ** :
:          :          * ** :
*****
      I JOBFILE          ***** EDUCFILE
      I
      I
      I
      I SECSEG
05      I KLU
*****
:SEC_CLEAR :
:
:
:
*****
      I JOBFILE
      I
      I
      I
      I SKILLSEG
06      I RL
*****
:SKILLS :
:SKILL_DESC :
:
:
:
*****

```

Displaying Fields From a Multi-Path Data Source

The following request produces a report displaying all of the fields on the left path of the EMPLOYEE data source.

```
TABLE FILE EMPLOYEE  
PRINT *  
END
```

The following shows a list of the output fields the previous request produces. Due to the size of the report, only the fields for which all instances will be printed are listed here. In the report, these fields would be displayed from left to right, starting with EMP_ID.

```
EMP_ID  
LAST_NAME  
FIRST_NAME  
HIRE_DATE  
DEPARTMENT  
CURR_SAL  
CURR_JOBCODE  
ED_HRS  
BANK_NAME  
BANK_CODE  
BANK_ACCT  
EFFECT_DATE  
DAT_INC  
PCT_INC  
SALARY  
JOBCODE  
JOBDESC  
JOB_DESC  
SEC_CLEAR  
SKILLS  
SKILL_DESC
```

Each field in this list appears in segments on the left path of the EMPLOYEE data source. To view the retrieval order structure of the EMPLOYEE data source, see [Displaying the Retrieval Order of a Multi-Path Data Source](#).



Tip: In some environments, the following warning is displayed whenever you use PRINT * with a multi-path data source, to remind you that PRINT * only displays the left path:

```
(FOC757) WARNING. YOU REQUESTED PRINT * OR COUNT * FOR A MULTI-  
PATH FILE
```

Adding Values

SUM, WRITE, and ADD sum the values of a numeric field. The three commands are synonyms; they can be used interchangeably, and every reference to SUM in this documentation also refers to WRITE and ADD.

When you use SUM, multiple records are read from the data source, but only one summary line is produced. If you use SUM with a non-numeric field—such as an alphanumeric, text, or date field—SUM does not add the values. Instead, by default, it displays the last value retrieved from the data source. You can change this to the first value, minimum value, or maximum value using the SUMPREFIX parameter.

For SUM, WRITE, and ADD syntax, see [Using Display Commands in a Request](#).

Adding Values

This request adds all the values of the field CURR_SAL:

```
TABLE FILE EMPLOYEE
SUM CURR_SAL
END
```

The following shows the output of the request.

```
NUMBER OF RECORDS IN TABLE=      12  LINES=      1
```

CURR_SAL	

\$222,284.00	

The number of lines in the report is less than the number of records from the data source. It took a total of 12 records to get the results in the report, but only one summary line is displayed.

Adding Non-Numeric Values

This request attempts to add non-numeric fields. Any request for aggregation on non-numeric data returns the last record retrieved from the data source.

```
TABLE FILE EMPLOYEE
SUM LAST_NAME AND FIRST_NAME
END
```

The following shows the output of the request.

LAST_NAME	FIRST_NAME
-----	-----
CROSS	BARBARA

Note that any request for aggregation on all date format fields also returns the last record retrieved from the data source.

✔ **Tip:** You can set the SUMPREFIX parameter to FST, MIN, MAX, or LST to control the sort order. For details, see [Sorting Tabular Reports](#).

Counting Values

The COUNT command counts the number of instances that exist for a specified field. The COUNT command is particularly useful when combined with the BY phrase, which is discussed in [Sorting Tabular Reports](#).

COUNT counts the instances of data contained in a report, not the data values.

For COUNT syntax, see [Using Display Commands in a Request](#).

By default, a COUNT field is a five-digit integer. You can reformat it using the COMPUTE command, and change its field length using the SET COUNTWIDTH parameter. For details

about the COMPUTE command, see [Creating Temporary Fields](#). For information about SET COUNTWIDTH, see the *ibi™ FOCUS® Developing Applications* manual.

When COUNT is used in a request, the word COUNT is appended to the default column title, unless the column title is changed with an AS phrase.

Counting Values

To determine how many employees are in the EMPLOYEE data source, you can count the instances of EMP_ID, the employee identification number.

```
TABLE FILE EMPLOYEE
COUNT EMP_ID
END
```

The following shows the output of the request.

```
EMP_ID
```

```
COUNT
```

```
-----
```

```
12
```

Counting Values With a Sort Phrase

To count the instances of EMP_ID for each department, use this request:

```
TABLE FILE EMPLOYEE
COUNT EMP_ID
```

```
BY DEPARTMENT
END
```

The following shows the output of the request indicating that of the 12 EMP_IDs in the data source, six are from the MIS department and six are from the PRODUCTION department:

DEPARTMENT	EMP_ID COUNT
-----	-----
MIS	6
PRODUCTION	6

Counting Instances of Data

The following example counts the instances of data in the LAST_NAME, DEPARTMENT, and JOBCODE fields in the EMPLOYEE data source.

```
TABLE FILE EMPLOYEE
COUNT LAST_NAME AND DEPARTMENT AND JOBCODE
END
```

The following shows the output of the request.

LAST_NAME COUNT	DEPARTMENT COUNT	JOBCODE COUNT
-----	-----	-----
12	12	19

The EMPLOYEE data source contains data on 12 employees, with one instance for each LAST_NAME. While there are only two values for DEPARTMENT, there are 12 instances of the DEPARTMENT field because each employee works for one of the two departments. Similarly, there are 19 instances of the JOBCODE field because employees can have more than one job code during their employment.

Counting Segment Instances

You can easily count the instances of the lowest segment in the left path of a data source by specifying an asterisk (*) wildcard instead of a specific field name. In a single-segment

data source, this effectively counts all instances in the data source.

COUNT * accomplishes this by counting the values of the first field in the segment. Instances with a missing value in the first field are not counted (when SET MISSING=ON).

Segment instances in short paths are not counted by COUNT *, regardless of the value of the ALL parameter of the SET command.

For more information about missing values, short paths, and the SET ALL parameter, see [Handling Records With Missing Field Values](#).

Counting Segments From a Multi-Path Data Source

The following request counts the number of instances of the SKILLSEG segment of the EMPLOYEE data source.

```
TABLE FILE EMPLOYEE
COUNT *
END
```

The following shows the output of the request.

```

COUNT *
-----
COUNT
-----
-----
-----
19
```

COUNT * counts the number of instances of the SKILLSEG segment, which is the lowest segment in the left path of the EMPLOYEE data source structure (that is, the EMPLOYEE data source joined to the JOBFIL and EDUCFIL data sources). You can see a picture of the path structure in [Displaying the Structure and Retrieval Order of a Multi-Path Data Source](#).

- ✔ **Tip:** In some environments, the following warning is displayed if you use COUNT * with a multi-path data source (such as EMPLOYEE in the above example):

```
(FOC757) WARNING. YOU REQUESTED PRINT * OR COUNT * FOR A MULTI-PATH FILE
```

Expanding Byte Precision for COUNT and LIST

By default, the number of characters that display for counter values retrieved using the COUNT and LIST commands is five. You can increase the number of characters to nine.

For example, if the number of records retrieved for a field exceeds 99,999 (5 bytes), asterisks appear in the report to indicate an overflow condition. You can increase the display to allow as large a count as 999,999,999 (9 bytes) using SET COUNTWIDTH.

- ⓘ **Note:** You can change the overflow character by issuing the SET OVERFLOWCHAR command.

Set the Precision for COUNT and LIST

```
SET COUNTWIDTH = {OFF|ON}
```

where:

OFF

Displays five characters (bytes) for COUNT and LIST counter values. Asterisks are displayed if the number of records retrieved for a field exceeds five characters. OFF is the default.

ON

Displays up to nine characters (bytes) for COUNT and LIST counter values. Asterisks are displayed if the value exceeds nine characters.

Setting Precision for COUNT and LIST

The following example shows the COUNT command with SET COUNTWIDTH = OFF:

```
TABLE FILE filename
COUNT Fldxx
BY Fldyy
END
```

	Fldxx
<u>Fldyy</u>	<u>COUNT</u>
value	*****

The following example shows the COUNT command with SET COUNTWIDTH = ON:

```
TABLE FILE filename
COUNT Fldxx
BY Fldyy
END
```

	Fldxx
<u>Fldyy</u>	<u>COUNT</u>
value	999999999

i Note: This feature affects the width of a report when COUNTWIDTH is set to ON. Calculating the width of a report now requires an additional four display positions for each COUNT or LIST column.

Maximum Number of Display Fields Supported in a Request

There is no limit to the number of verb objects in a TABLE or MATCH request.

However, an error can occur under the following conditions:

- The report output format has a limit to the number of columns supported. For example, Excel, FOCUS, and XFOCUS formats have limits on the number of columns.
- The operating system has a maximum record length that cannot fit all of the columns.
- The amount of memory needed to store the output is not available.

If the combined length of the display fields in the data area exceeds the maximum capacity, an error message displays. To correct the problem, adjust the number or lengths of the fields in the request.

Manipulating Display Fields With Prefix Operators

You can use prefix operators to perform calculations directly on the values of fields.

i Note: Unless you change a column or ACROSS title with an AS phrase, the prefix operator is automatically added to the title. Without an AS phrase, the column title is constructed using the prefix operator and either the field name or the TITLE attribute in the Master File (if there is one):

- If there is no TITLE attribute, the field name is used.

- If there is a TITLE attribute in the Master File, the choice between using the field name or the TITLE attribute depends on the value of the TITLES parameter:
 - If SET TITLES = ON, the TITLE attribute is used.
 - If SET TITLES = OFF or NOPREFIX, the field name is used.

You can use the SET PRFTITLE command to create descriptive and translatable column titles for prefixed fields. For example, the following request sets PRFTITLE to LONG.

```
SET PRFTITLE = LONG
TABLE FILE WFLITE
SUM COGS_US CNT.COGS_US AVE.COGS_US CNT.DST.COGS_US MIN.COGS_US
MAX.COGS_US MDN.COGS_US
BY PRODUCT_CATEGORY
ON TABLE SET PAGE NOLEAD
ON TABLE SET STYLE *
GRID=OFF,$
ENDSTYLE
END
```

The output is shown in the following image. The prefix operator names are converted to descriptive text.

Product Category	Cost of Goods	Count of Goods	Average Cost of Goods	Count of Distinct Cost of Goods	Minimum Cost of Goods	Maximum Cost of Goods	Median Cost of Goods
Accessories	\$342,877.00	1484	\$231.05	50	\$16.00	\$2,850.00	\$174.00
Camcorder	\$453,205.00	1417	\$319.83	46	\$60.00	\$8,610.00	\$180.00
Computers	\$109,281.00	600	\$182.13	8	\$81.00	\$668.00	\$167.00
Media Player	\$779,593.00	2249	\$346.64	77	\$36.00	\$1,640.00	\$310.00
Stereo Systems	\$857,042.00	3338	\$256.75	100	\$48.00	\$2,700.00	\$166.00
Televisions	\$227,820.00	267	\$853.26	22	\$275.00	\$9,750.00	\$550.00
Video Production	\$180,540.00	645	\$279.91	21	\$78.00	\$1,880.00	\$190.00

If PRFTITLE had been set to SHORT (the default), the prefix operator name would have been used instead of the descriptive text.

For a list of prefix operators and their functions, see [Manipulating Display Fields With Prefix Operators](#).

Prefix Operator Basics

This topic describes basic syntax and notes for using prefix operators.

Use Prefix Operators

Each prefix operator is applied to a single field, and affects only that field.

```
{SUM|COUNT} prefix.fieldname AS 'coltitle'
```

```
{PRINT|COMPUTE} RNK.byfield
```

where:

prefix

Is any prefix operator.

fieldname

Is the name of the field to be displayed in the report.

'coltitle'

Is the column title for the report column, enclosed in single quotation marks.

byfield

Is the name of a vertical sort field to be ranked in the report.

Usage Notes for Prefix Operators

- Because PRINT and LIST display individual field values, not an aggregate value, they are not used with prefix operators, except TOT. and DST.
- To sort by the results of a prefix command, use the phrase BY TOTAL to aggregate and sort numeric columns simultaneously. For details, see [Sorting Tabular Reports](#).
- The WITHIN phrase is very useful when using prefixes. The WITHIN phrase is not supported with the MDN., MDE., DST., CNT.DST., AVE.DST., or SUM.DST. prefix operators in an aggregation display command, such as SUM. The WITHIN phrase is supported with the DST. operator with the PRINT display command.
- You can use the results of prefix operators in COMPUTE commands.

- With the exception of PCT., RPCT., CNT. and PCT.CNT., resulting values have the same format as the field against which the prefix operation was performed.
- For percent-based prefix operators PCT. and RPCT., if you set the PCTFORMAT parameter to OLD, the resulting values have the same format as the field against which the prefix operation was performed. By default, PCTFORMAT is set to PERCENT, which displays the prefixed column with a percent sign and removes other options, such as currency symbols, although you can reformat it. PCT.CNT.*field* will always display with two decimal places and a percent sign, unless reformatted. With PCTFORMAT = PERCENT, the format of the output column may depend on the format of the original field. For a field with a:
 - Precision-based format (F, D, M, X), the column will display with length 7 and two decimal places.
 - Packed format, the column will display with its original number of decimal places.
 - Integer format, the column will display with no decimal places.
- Text fields can only be used with the FST., LST., and CNT. prefix operators.
- PCT., TOT., PCT.CNT., RNK., and RPCT. are *not* supported with TABLEF and should not be used with TABLEF.
- It is recommended to avoid using a prefix operator as a Master File name, either from the WebFOCUS Reporting Server or in a HOLD file.

Functions You Can Perform With Prefix Operators

The following table lists prefix operators and describes the function of each.

Prefix	Function
ASQ.	Computes the average sum of squares for standard deviation in statistical analysis.

Prefix	Function
AVE.	Computes the average value of the field.
CNT.	Counts the number of occurrences of the field. The data type of the result is always Integer.
AVE.DST.	Averages the distinct values within a field.
CNT.DST.	Counts the number of distinct values within a field.
SUM.DST.	Sums the distinct values within a field.
CT.	Produces a cumulative total of the specified field. This operator only applies when used in subfootings.
DST.	Determines the total number of distinct values in a single pass of a data source.
FST.	Generates the first physical instance of the field. Can be used with numeric or text fields.
LST.	Generates the last physical instance of the field. Can be used with numeric or text fields.
MAX.	Generates the maximum value of the field.
MDE.	Computes the mode of the field values.

Prefix	Function
MDN.	Computes the median of the field values.
MIN.	Generates the minimum value of the field.
PCT.	Computes a field percentage based on the total values for the field. The PCT operator can be used with detail as well as summary fields.
PCT.CNT.	Computes a field percentage based on the number of instances found. The format of the result is always F6.2 and cannot be reformatted.
RNK.	Ranks the instances of a BY sort field in the request. Can be used in PRINT commands, COMPUTE commands, and IF or WHERE TOTAL tests.
ROLL.	Recalculates values on summary lines using the aggregated values from lower level summary lines.
RPCT.	Computes a field percentage based on the total values for the field across a row.
ST.	Produces a subtotal value of the specified field at a sort break in the report. This operator only applies when used in subfootings.
STDP.	Computes the standard deviation for a population.
STDS.	Computes the standard deviation for a sample.
SUM.	Sums the field values.

Prefix	Function
TOT.	Totals the field values for use in a heading (includes footings, subheads, and subfoots).

Averaging Values of a Field

The AVE. prefix computes the average value of a particular field. The computation is performed at the lowest sort level of the display command. It is computed as the sum of the field values within a sort group divided by the number of records in that sort group. If the request does not include a sort phrase, AVE. calculates the average for the entire report.

Averaging Values of a Field

This request calculates the average number of education hours spent in each department.

```
TABLE FILE EMPLOYEE
SUM AVE.ED_HRS BY DEPARTMENT
END
```

The following shows the output of the request.

```

      AVE
DEPARTMENT  ED_HRS
-----  -----
MIS          38.50
PRODUCTION  20.00
```

Averaging the Sum of Squared Fields

The ASQ. prefix computes the average sum of squares, which is a component of the standard deviation in statistical analysis (shown as a formula in the following image).

$$\left(\sum_{i=1}^n x_i^2 \right)$$

i Note: If the field format is integer and you get a large set of numbers, the ASQ. result may exceed the limit of the I4 field, which is 2,147,483,647. The display of any number larger than this will generate a negative number or an incorrect positive number. For this reason, we recommend that you do not use Integer fields if this result could occur.

Averaging the Sum of Squared Fields

This request calculates the sum and the sum of squared fields for the DELIVER_AMT field.

```
TABLE FILE SALES
SUM DELIVER_AMT AND ASQ.DELIVER_AMT
BY CITY
END
```

The following shows the output of the request.

CITY	DELIVER_AMT	ASQ DELIVER_AMT
----	-----	-----
NEW YORK	300	980
NEWARK	60	900
STAMFORD	430	3637
UNIONDALE	80	1600

Calculating Maximum and Minimum Field Values

The prefixes MAX. and MIN. produce the maximum and minimum values, respectively, within a sort group. If the request does not include a sort phrase, MAX. and MIN. produce the maximum and minimum values for the entire report.

Calculating Maximum and Minimum Field Values

This report request calculates the maximum and minimum values of SALARY.

```
TABLE FILE EMPLOYEE
SUM MAX.SALARY AND MIN.SALARY
END
```

The following shows the output of the request.

MAX SALARY -----	MIN SALARY -----
\$29,700.00	\$8,650.00

Calculating Median and Mode Values for a Field

You can use the MDN. (median) and MDE. (mode) prefix operators, in conjunction with an aggregation display command (SUM, WRITE) and a numeric or smart date field, to calculate the statistical median and mode of the values in the field.

These calculations are not supported in a DEFINE command, in WHERE or IF expressions, in a WITHIN phrase, or in a summary command. If used in a multi-verb request, they must be used at the lowest level of aggregation.

The median is the middle value (50th percentile). If there is an even number of values, the median is the average of the middle two values. The mode is the value that occurs most frequently within the set of values. If no value occurs more frequently than the others, MDE. returns the lowest value.

Calculating the Median and Mode

The following request against the EMPLOYEE data source displays the current salaries and calculates the average (mean), median, and mode within each department.

```
TABLE FILE EMPLOYEE
SUM CURR_SAL AS 'INDIVIDUAL', SALARIES'
```



```

AVE.CURR_SAL AS 'DEPARTMENT,AVERAGE'
MDN.CURR_SAL AS 'DEPARTMENT,MEDIAN'
MDE.CURR_SAL AS 'DEPARTMENT,MODE'
BY DEPARTMENT
ON TABLE SET PAGE NOPAGE
END

```

Both departments have an even number of employees. For the MIS department, the two middle values are the same, making that value (\$18,480.00) both the median and the mode. For the PRODUCTION department, the median is the average of the two middle values (\$16,100.00 and \$21,120.00) and, since there are no duplicate values, the mode is the lowest value (\$9,500.00).

<u>DEPARTMENT</u>	<u>INDIVIDUAL SALARIES</u>	<u>DEPARTMENT AVERAGE</u>	<u>DEPARTMENT MEDIAN</u>	<u>DEPARTMENT MODE</u>
MIS	\$108,002.00	\$18,000.33	\$18,480.00	\$18,480.00
PRODUCTION	\$114,282.00	\$19,047.00	\$18,610.00	\$9,500.00

Calculating Column and Row Percentages

For each individual value in a column, PCT. calculates what percentage that field makes up of the column total value. You can control how values are distributed down the column by sorting the column using the BY phrase.

You can also determine percentages for row values. For each individual value in a row that has been sorted using the ACROSS phrase, the RPCT. operator calculates what percentage it makes up for the total value of the row.

Calculating Column Percentages

To calculate each employee share of education hours, issue the following request:

```

TABLE FILE EMPLOYEE
SUM ED_HRS PCT.ED_HRS BY LAST_NAME
ON TABLE COLUMN-TOTAL
ON TABLE SET PAGE NOPAGE
ON TABLE SET STYLE *
GRID=OFF,$

```

```
ENDSTYLE
END
```

The output is shown in the following image:

<u>LAST_NAME</u>	<u>ED_HRS</u>	<u>PCT ED_HRS</u>
BANNING	.00	.00%
BLACKWOOD	75.00	21.37%
CROSS	45.00	12.82%
GREENSPAN	25.00	7.12%
IRVING	30.00	8.55%
JONES	50.00	14.25%
MCCOY	.00	.00%
MCKNIGHT	50.00	14.25%
ROMANS	5.00	1.42%
SMITH	46.00	13.11%
STEVENS	25.00	7.12%
TOTAL	351.00	100.00%

If you set PCFORMAT to OLD, PCT. and RPCT. WILL take the same format as the field, and the column may not always total exactly 100 because of the nature of floating-point arithmetic.

Calculating Row Percentages

The following request calculates the total units sold for each product (UNIT_SOLD column), and the percentage that total makes up in relation to the sum of all products sold (RPCT.UNIT_SOLD column) in each city.

```
TABLE FILE SALES
SUM UNIT_SOLD RPCT.UNIT_SOLD ROW-TOTAL
BY PROD_CODE
ACROSS CITY WHERE
CITY EQ 'NEW YORK' OR 'STAMFORD'
ON TABLE SET PAGE NOPAGE
ON TABLE SET STYLE *
GRID=OFF,$
```

```
ENDSTYLE
END
```

The output is shown in the following image.

PROD_CODE	CITY NEW YORK		STAMFORD		TOTAL	
	UNIT_SOLD	RPCT UNIT_SOLD	UNIT_SOLD	RPCT UNIT_SOLD	UNIT_SOLD	RPCT UNIT_SOLD
B10	30	33%	60	66%	90	99%
B12	.	.	40	100%	40	100%
B17	20	40%	29	59%	49	99%
B20	15	100%	.	.	15	100%
C13	.	.	25	100%	25	100%
C17	12	100%	.	.	12	100%
C7	.	.	45	100%	45	100%
D12	20	42%	27	57%	47	99%
E1	30	100%	.	.	30	100%
E2	.	.	80	100%	80	100%
E3	35	33%	70	66%	105	99%

Because UNIT_SOLD has an integer format, the columns created by RPCT. also have integer (I) formats. Therefore, individual percentages may be truncated and the total percentage may be less than 100%. If you require precise totals, redefine the field with a format that declares decimal places (D, F).

Producing a Direct Percent of a Count

When counting occurrences in a file, a common reporting need is determining the relative percentages of each row's count within the total number of instances. You can do this, for columns only, with the following syntax:

```
PCT.CNT.fieldname
```

The format is a decimal value of length seven, with two decimal places and a percent sign.

Producing a Direct Percent of a Count

This request illustrates the relative percentage of the values in the EMP_ID field for each department.

```
TABLE FILE EMPLOYEE
SUM PCT.CNT.EMP_ID
BY DEPARTMENT
ON TABLE SET PAGE NOPAGE
ON TABLE SET STYLE *
GRID=OFF,$
ENDSTYLE
END
```

The output is shown in the following image:

<u>DEPARTMENT</u>	<u>PCT.CNT EMP_ID</u>
MIS	50.00%
PRODUCTION	50.00%

Aggregating and Listing Unique Values

The distinct prefix operator (DST.) may be used to aggregate and list unique values of any data source field. Similar in function to the SQL COUNT, SUM, and AVG(DISTINCT col) column functions, it permits you to determine the total number of distinct values in a single pass of the data source.

The DST. operator can be used with the SUM, PRINT or COUNT commands, and also in conjunction with the aggregate prefix operators SUM., CNT., and AVE. Multiple DST. operators are supported in TABLE and TABLEF requests. They are supported in requests that use the BY, ACROSS, and FOR phrases.

Note that in a request using the PRINT command and multiple DST operators, you should issue the command SET PRINTDST=NEW. For more information, see the *ibi™ FOCUS® Developing Applications* manual.

Use the Distinct Operator

```
command DST.fieldname
```

or

```
SUM [operator].DST.fieldname
```

where:

command

Is SUM, PRINT, or COUNT.

DST.

Indicates the distinct operator.

fieldname

Indicates the display-field object or field name.

operator

Indicates SUM., CNT., or AVE.

Using the Distinct Operator

The procedure requesting a count of unique ED_HRS values is either:

```
TABLE FILE EMPLOYEE
SUM CNT.DST.ED_HRS
END
```

or

```
TABLE FILE EMPLOYEE
COUNT DST.ED_HRS
END
```

The output is:

```
COUNT
DISTINCT
ED_HRS
-----
          9
```

Notice that the count includes records for both employees with the last name SMITH, but excludes the second records for values 50.00, 25.00, and .0, resulting in nine unique ED_HRS values.

Counting Distinct Field Values With Multiple Display Commands

The following request against the GGSales data source counts the total number of records by region, then the number of records, distinct categories, and distinct products by region and by state. The DST or CNT.DST operator can be used only with the last display command:

```
TABLE FILE GGSales
COUNT CATEGORY AS 'TOTAL,COUNT'
  BY REGION
SUM CNT.CATEGORY AS 'STATE,COUNT'
  CNT.DST.CATEGORY    CNT.DST.PRODUCT
  BY REGION
  BY ST
END
```

The output is:

Region	TOTAL COUNT	State	STATE COUNT	COUNT DISTINCT CATEGORY	COUNT DISTINCT PRODUCT
Midwest	1085	IL	362	3	9
		MO	361	3	9
		TX	362	3	9
Northeast	1084	CT	361	3	10
		MA	360	3	10
		NY	363	3	10
Southeast	1082	FL	361	3	10
		GA	361	3	10
		TN	360	3	10
West	1080	CA	721	3	10
		WA	359	3	10

Distinct Operator Limitations

- If you reformat a column created using COUNT DST. or the CNT.DST operator, you must reformat it to an integer (I) data type. If you specify another data type, the following error occurs:

```
(FOC950) INVALID REFORMAT OPTION WITH COUNT OR CNT.
```

- The following error occurs if you use the prefix operators CNT., SUM., and AVE. with any other display command:

```
(FOC1853) CNT/SUM/AVE.DST CAN ONLY BE USED WITH AGGREGATION VERBS
```

- The following error occurs if you use DST. in a MATCH command:

```
(FOC1854) THE DST OPERATOR IS ONLY SUPPORTED IN TABLE REQUESTS
```

- The following error occurs if you reformat a BY field (when used with the PRINT command, the DST.*fieldname* becomes a BY field):

```
(FOC1862) REFORMAT DST.FIELD IS NOT SUPPORTED WITH PRINT
```

- The following error occurs if you use the DST. operator with NOSPLIT:

```
(FOC1864) THE DST OPERATOR IS NOT SUPPORTED WITH NOSPLIT
```

- The following error occurs if you use a multi-verb request, SUM DST.*fieldname* BY *field* PRINT *fld* BY *fld* (a verb object operator used with the SUM command must be at the lowest level of aggregation):

```
(FOC1867) DST OPERATOR MUST BE AT THE LOWEST LEVEL OF AGGREGATION
```

- The DST. operator may not be used as part of a HEADING or a FOOTING.
- The DST., AVE.DST, CNT.DST., and SUM.DST. operators are not supported with WITHIN in a request that uses an aggregation display command, such as SUM. The DST. operator is supported with WITHIN when the request uses the PRINT display command.

Retrieving First and Last Records

FST. is a prefix that displays the first retrieved record selected for a given field. LST. displays the last retrieved record selected for a given field.

When using the FST. and LST. prefix operators, it is important to understand how your data source is structured.

- If the record is in a segment with values organized from lowest to highest (segment type S1), the first logical record that the FST. prefix operator retrieves is the lowest value in the set of values. The LST. prefix operator would, therefore, retrieve the highest value in the set of values.
- If the record is in a segment with values organized from highest to lowest (segment type SH1), the first logical record that the FST. prefix operator retrieves is the highest value in the set of values. The LST. prefix operator would, therefore, retrieve the lowest value in the set of values.

For more information on segment types and file design, see the *ibi™ FOCUS® Describing Data* manual. If you wish to reorganize the data in the data source or restructure the data source while reporting, see [Improving Report Processing](#).

Retrieving the First Record

The following request retrieves the first logical record in the EMP_ID field:

```
TABLE FILE EMPLOYEE
SUM FST.EMP_ID
END
```

The output is:

```
FST
EMP_ID
-----
071382660
```

Segment Types and Retrieving Records

The EMPLOYEE data source contains the DEDUCT segment, which orders the fields DED_CODE and DED_AMT from lowest value to highest value (segment type of S1). The DED_CODE field indicates the type of deduction, such as CITY, STATE, FED, and FICA. The following request retrieves the first logical record for DED_CODE for each employee:

```
TABLE FILE EMPLOYEE
SUM FST.DED_CODE
BY EMP_ID
END
```

The output is:

EMP_ID	FST DED_CODE
-----	-----
071382660	CITY
112847612	CITY
117593129	CITY
119265415	CITY
119329144	CITY
123764317	CITY
126724188	CITY
219984371	CITY
326179357	CITY
451123478	CITY
543729165	CITY
818692173	CITY

Note, however, the command SUM LST.DED_CODE would have retrieved the last logical record for DED_CODE for each employee.

If the record is in a segment with values organized from highest to lowest (segment type SH1), the first logical record that the FST. prefix operator retrieves is the highest value in the set of values. The LST. prefix operator would therefore retrieve the lowest value in the set of values.

For example, the EMPLOYEE data source contains the PAYINFO segment, which orders the fields JOBCODE, SALARY, PCT_INC, and DAT_INC from highest value to lowest value (segment type SH1). The following request retrieves the first logical record for SALARY for each employee:

```
TABLEF FILE EMPLOYEE
SUM FST.SALARY
BY EMP_ID
END
```

The output is:

EMP_ID	FST SALARY
-----	-----
071382660	\$11,000.00
112847612	\$13,200.00
117593129	\$18,480.00
119265415	\$9,500.00
119329144	\$29,700.00
123764317	\$26,862.00
126724188	\$21,120.00
219984371	\$18,480.00
326179357	\$21,780.00
451123478	\$16,100.00
543729165	\$9,000.00
818692173	\$27,062.00

However, the command `SUM LST.SALARY` would have retrieved the last logical record for SALARY for each employee.

Summing and Counting Values

You can count occurrences and summarize values with one display command using the prefix operators `CNT.`, `SUM.`, and `TOT.` Just like the `COUNT` command, `CNT.` counts the occurrences of the field it prefixes. Just like the `SUM` command, `SUM.` sums the values of the field it prefixes. `TOT.` sums the values of the field it prefixes when used in a heading (including footings, subheads, and subfoots).

Counting Values With CNT

The following request counts the occurrences of `PRODUCT_ID`, and sums the value of `UNIT_PRICE`.

```
TABLE FILE GGPRODS
SUM CNT.PRODUCT_ID AND UNIT_PRICE
END
```

The output is:

Product Code COUNT -----	Unit Price -----
10	660.00

Summing Values With SUM

The following request counts the occurrences of PRODUCT_ID, and sums the value of UNIT_PRICE.

```
TABLE FILE GGPRODS
COUNT PRODUCT_ID AND SUM.UNIT_PRICE
END
```

The output is:

Product Code COUNT -----	Unit Price -----
10	660.00

Summing Values With TOT

The following request uses the TOT prefix operator to show the total of current salaries for all employees.

```
TABLE FILE EMPLOYEE
PRINT LAST_NAME
BY DEPARTMENT
```

```
ON TABLE SUBFOOT
"Total salaries equal: <TOT.CURR_SAL"
END
```

The output is:

```
DEPARTMENT  LAST_NAME
-----
MIS          SMITH
             JONES
             MCCOY
             BLACKWOOD
             GREENSPAN
             CROSS
PRODUCTION  STEVENS
             SMITH
             BANNING
             IRVING
             ROMANS
             MCKNIGHT
Total salaries equal:      $222,284.00
```

Ranking Sort Field Values With RNK.

RANKED BY *fieldname*, when used in a sort phrase in a TABLE request, not only sorts the data by the specified field, but assigns a RANK value to the instances. The RNK. prefix operator also calculates the rank while allowing the RANK value to be printed anywhere on the page. You use this operator by specifying RNK.*fieldname*, where *fieldname* is a BY field in the request.

The ranking process occurs after selecting and sorting records. Therefore, the RNK. operator cannot be used in a WHERE or IF selection test or in a virtual (DEFINE) field. However, RNK.*fieldname* can be used in a WHERE TOTAL or IF TOTAL test or in a calculated (COMPUTE) value. You can change the default column title for the rank field using an AS phrase.

You can apply the RNK. operator to multiple sort fields, in which case the rank for each BY field is calculated within its higher level BY field.

Calculate Ranks Using the RNK. Prefix Operator

In a PRINT command, COMPUTE expression, or IF/WHERE TOTAL expression :

```
RNK.field ...
```

where:

field

Is a vertical (BY) sort field in the request.

Ranking Within Sort Groups

The following request ranks years of service within department and ranks salary within years of service and department. Note that years of service depends on the value of TODAY. The output for this example was valid when run in September, 2006:

```
DEFINE FILE EMPDATA
  TODAY/YYMD = &YYMD;
  YRS_SERVICE/I9 = DATEDIF(HIREDATE,TODAY,'Y');
END
TABLE FILE EMPDATA
PRINT SALARY
  RNK.YRS_SERVICE AS 'RANKING,BY,SERVICE'
  RNK.SALARY AS 'SALARY,RANK'
  BY DEPT
  BY HIGHEST YRS_SERVICE
  BY HIGHEST SALARY NOPRINT
WHERE DEPT EQ 'MARKETING' OR 'SALES'
ON TABLE SET PAGE NOPAGE
END
```

The output is:

DEPT	YRS_SERVICE	SALARY	RANKING BY SERVICE	SALARY RANK
----	-----	-----	-----	-----
MARKETING	17	\$55,500.00	1	1
		\$55,500.00	1	1
	16	\$62,500.00	2	1

		\$62,500.00	2	1
		\$62,500.00	2	1
		\$58,800.00	2	2
		\$52,000.00	2	3
		\$35,200.00	2	4
		\$32,300.00	2	5
	15	\$50,500.00	3	1
		\$43,400.00	3	2
SALES	17	\$115,000.00	1	1
		\$54,100.00	1	2
	16	\$70,000.00	2	1
		\$43,000.00	2	2
	15	\$43,600.00	3	1
		\$39,000.00	3	2
	15	\$30,500.00	3	3

Using RNK. in a WHERE TOTAL Test

The following request displays only those rows in the highest two salary ranks within the years of service category. Note that years of service depends on the value of TODAY. The output for this example was valid when run in September, 2006:

```

DEFINE FILE EMPDATA
  TODAY/YYMD = &YYMD;
  YRS_SERVICE/I9 = DATEDIF(HIREDATE,TODAY,'Y');
END
TABLE FILE EMPDATA
PRINT LASTNAME FIRSTNAME RNK.SALARY
BY HIGHEST YRS_SERVICE BY HIGHEST SALARY
WHERE TOTAL RNK.SALARY LE 2
END

```

The output is:

YRS_SERVICE	SALARY	LASTNAME	FIRSTNAME	RANK SALARY
-----	-----	-----	-----	-----
17	\$115,000.00	LASTRA	KAREN	1
	\$80,500.00	NOZAWA	JIM	2
16	\$83,000.00	SANCHEZ	EVELYN	1
	\$70,000.00	CASSANOVA	LOIS	2
15	\$62,500.00	HIRSCHMAN	ROSE	1

	WANG	JOHN	1
\$50,500.00	LEWIS	CASSANDRA	2

Using RNK. in a COMPUTE Command

The following request sets a flag to **Y** for records in which the salary rank within department is less than or equal to 5 and the rank of years of service within salary and department is less than or equal to 6. Otherwise, the flag has the value **N**. Note that the years of service depends on the value of TODAY. The output for this example was valid when run in September, 2006:

```

DEFINE FILE EMPDATA
  TODAY/YYMD = &YYMD;
  YRS_SERVICE/I9 = DATEDIF(HIREDATE, TODAY, 'Y');
END
TABLE FILE EMPDATA
PRINT RNK.SALARY RNK.YRS_SERVICE
COMPUTE FLAG/A1 = IF RNK.SALARY LE 5 AND RNK.YRS_SERVICE LE 6
  THEN 'Y' ELSE 'N';
BY DEPT BY SALARY BY YRS_SERVICE
WHERE DEPT EQ 'MARKETING' OR 'SALES'
ON TABLE SET PAGE NOPAGE
END

```

The output is:

DEPT	SALARY	YRS_SERVICE	RANK SALARY	RANK YRS_SERVICE	FLAG
----	-----	-----	-----	-----	-----
MARKETING	\$32,300.00	16	1		1 Y
	\$35,200.00	16	2		1 Y
	\$43,400.00	15	3		1 Y
	\$50,500.00	15	4		1 Y
	\$52,000.00	16	5		1 Y
	\$55,500.00	17	6		1 N
			6		1 N
	\$58,800.00	16	7		1 N
	\$62,500.00	16	8		1 N
			8		1 N
			8		1 N
SALES	\$30,500.00	15	1		1 Y

\$39,000.00	15	2	1 Y
\$43,000.00	16	3	1 Y
\$43,600.00	15	4	1 Y
\$54,100.00	17	5	1 Y
\$70,000.00	16	6	1 N
\$115,000.00	17	7	1 N

Rolling Up Calculations on Summary Rows

Using SUMMARIZE and RECOMPUTE, you can recalculate values at sort field breaks, but these calculations use the detail data to calculate the value for the summary line.

Using the ROLL. operator in conjunction with another prefix operator on a summary line recalculates the sort break values using the values from summary lines generated for the lower level sort break.

The operator combinations supported are:

- ROLL.SUM. (same as ROLL.). Alphanumeric fields are supported with SUM. This returns either the first, minimum, maximum, or last value according to the SUMPREFIX parameter.
- ROLL.AVE.
- ROLL.MAX. (supported with alphanumeric fields as well as numeric fields)
- ROLL.MIN. (supported with alphanumeric fields as well as numeric fields)
- ROLL.FST. (supported with alphanumeric fields as well as numeric fields)
- ROLL.LST. (supported with alphanumeric fields as well as numeric fields)
- ROLL.CNT.
- ROLL.ASQ.

ROLL.**prefix** on a summary line indicates that the prefix operation will be performed on the summary values from the next lowest level of summary command.

If the ROLL. operator is used without another prefix operator, it is treated as a SUM. Therefore, if the summary command for the lowest BY field specifies AVE., and the next higher specifies ROLL., the result will be the sum of the averages. To get the average of the averages, you would use ROLL.AVE at the higher level.

i Note: With SUMMARIZE and SUB-TOTAL, the same calculations are propagated to all higher level sort breaks.

Roll Up Summary Values

```
BY field {SUMMARIZE|SUBTOTAL|SUB-TOTAL|RECOMPUTE} [ROLL.][prefix1.]
[field1field2 ...|*] [ROLL.][prefix2.] [fieldn ...]
```

Or:

```
BY field
```

```
ON field {SUMMARIZE|SUBTOTAL|SUB-TOTAL|RECOMPUTE} ROLL.[prefix.]
[field1field2 ...|*]
```

where:

ROLL.

Indicates that the summary values should be calculated using the summary values from the next lowest level summary command.

field

Is a BY field in the request.

prefix1, prefix2

Are prefix operators to use for the summary values. It can be one of the following operators: SUM. (the default operator if none is specified), AVE., MAX., MIN., FST., LST., CNT., ASQ.

field1field2fieldn

Are fields to be summarized.

Indicates that all fields, numeric and alphanumeric, should be included on the summary lines. You can either use the asterisk to display all columns or reference the specific

columns you want to display.

Rolling Up an Average Calculation

The following request against the GGSales data source contains two sort fields, REGION and ST. The summary command for REGION applies the AVE. operator to the sum of the units value for each state.

```
TABLE FILE GGSales
  SUM UNITS AS 'Inventory '
  BY REGION
  BY ST
  ON REGION SUBTOTAL      AVE. AS 'Average'
  WHERE DATE GE 19971001
  WHERE REGION EQ 'West' OR 'Northeast'
  ON TABLE SET PAGE NOPAGE
  END
```

On the output, the UNITS values for each state are averaged to calculate the subtotal for each region. The UNITS values for each state are also used to calculate the average for the grand total row.

Region	State	Inventory
-----	-----	-----
Northeast	CT	37234
	MA	35720
	NY	36248
Average Northeast		36400
West	CA	75553
	WA	40969
Average West		58261
TOTAL		45144

The following version of the request adds a summary command for the grand total line that includes the ROLL. operator:

```

TABLE FILE GGSALES
  SUM UNITS AS 'Inventory '
  BY REGION
  BY ST
  ON REGION SUBTOTAL AVE. AS 'Average'
  WHERE DATE GE 19971001
  WHERE REGION EQ 'West' OR 'Northeast'
  ON TABLE SUBTOTAL ROLL.AVE. AS ROLL.AVE
  ON TABLE SET PAGE NOPAGE
  END

```

On the output, the UNITS values for each state are averaged to calculate the subtotal for each region, and those region subtotal values are used to calculate the average for the grand total row:

Region	State	Inventory
-----	-----	-----
Northeast	CT	37234
	MA	35720
	NY	36248
Average Northeast		36400
West	CA	75553
	WA	40969
Average West		58261
ROLL.AVE		47330

Propagating Rollups to Higher Level Sort Breaks

The following request against the GGSALES data source has three BY fields. The SUBTOTAL command for the PRODUCT sort field specifies AVE., and the SUMMARIZE command for the higher level sort field, REGION, specifies ROLL.AVE.

```

TABLE FILE GGSALES
  SUM UNITS

```

```

BY REGION
BY PRODUCT
BY HIGHEST DATE
WHERE DATE GE 19971001
  WHERE REGION EQ 'Midwest' OR 'Northeast'
  WHERE PRODUCT LIKE 'C%'
  ON PRODUCT SUBTOTAL AVE.
  ON REGION SUMMARIZE ROLL.AVE. AS ROLL.AVE
ON TABLE SET PAGE NOPAGE
END

```

On the output, the detail rows for each date are used to calculate the average for each product. Because of the ROLL.AVE. at the region level, the averages for each product are used to calculate the averages for each region, and the region averages are used to calculate the average for the grand total line:

Region	Product	Date	Unit Sales
-----	-----	----	-----
Midwest	Coffee Grinder	1997/12/01	4648
		1997/11/01	3144
		1997/10/01	1597
	*TOTAL PRODUCT Coffee Grinder		3129
	Coffee Pot	1997/12/01	1769
		1997/11/01	1462
		1997/10/01	2346
	*TOTAL PRODUCT Coffee Pot		1859
	Croissant	1997/12/01	7436
		1997/11/01	5528
		1997/10/01	6060
	*TOTAL PRODUCT Croissant		6341
	ROLL.AVE Midwest		3776
Northeast	Capuccino	1997/12/01	1188
		1997/11/01	2282
		1997/10/01	3675
	*TOTAL PRODUCT Capuccino		2381
	Coffee Grinder	1997/12/01	1536
		1997/11/01	1399

	1997/10/01	1315
*TOTAL PRODUCT Coffee Grinder		1416
Coffee Pot	1997/12/01	1442
	1997/11/01	2129
	1997/10/01	2082
*TOTAL PRODUCT Coffee Pot		1884
Croissant	1997/12/01	4291
	1997/11/01	6978
	1997/10/01	4741
*TOTAL PRODUCT Croissant		5336
ROLL.AVE Northeast		2754
TOTAL		3265

Usage Notes for ROLL.

- ROLL.**prefix** on a summary line indicates that the prefix operation will be performed on the summary values from the next lowest level of summary command.
- If no summary command was issued at the level below the ROLL., and no other operator was used in conjunction with the ROLL., a SUM. will be calculated. If the lower level had no summary command and ROLL. was used with another prefix operator (for example, ROLL.AVE.), the specified prefix operator will be used. For example, ROLL.AVE. will become AVE.
- CNT. **prefix** shows the number of data lines displayed, which is not affected by MULTILINES.
- ROLL.CNT. **prefix** shows the number of summary lines displayed, which is affected by MULTILINES.

Calculating the Standard Deviation for a Population or a Sample

The standard deviation prefix operators return a numeric value that represents the amount of dispersion in the data. The set of data can be specified as the entire population (STDP.) or a sample (STDS.). The standard deviation is the square root of the variance, which is a measure of how observations deviate from their expected value (mean). If specified as a population, the divisor in the standard deviation calculation (also called degrees of freedom) will be the total number of data points, N. If specified as a sample, the divisor will be N-1.

If x_i is an observation, N is the number of observations, and μ is the mean of all of the observations, the formula for calculating the standard deviation for a population is:

$$\sqrt{\frac{1}{N} \sum_{i=1}^N (x_i - \mu)^2}$$

To calculate the standard deviation for a sample, the mean is calculated using the sample observations, and the divisor is N-1 instead of N.

To calculate the standard deviation for a population, the syntax is:

```
STDP.field
```

To calculate the standard deviation for a sample, the syntax is:

```
STDS.field
```

where:

field

Numeric

Is the set of observations for the standard deviation calculation.

Calculating the Standard Deviation of a Population

The following request calculates the standard deviation of the population of the DOLLARS field converted to double precision.

```
DEFINE FILE ibisamp/ggsales
DOLLARS/D12.2 = DOLLARS;
END
TABLE FILE ibisamp/ggsales
SUM DOLLARS STDP.DOLLARS
ON TABLE SET PAGE NOLEAD
ON TABLE SET STYLE *
GRID=OFF,$
ENDSTYLE
END
```

The output is shown in the following image.

<u>DOLLARS</u>	<u>STDP DOLLARS</u>
46,156,290.00	6,156.997845651

Using Report-Level Prefix Operators

Report level prefix operators are available for headings, footings, subheadings, subfootings, verb objects, and calculated values (COMPUTEs) that calculate the average, maximum, minimum, and count for the entire report. They are based on the TOT. operator, which calculates total values to include in a heading.

These operators cannot be referenced in WHERE or WHERE TOTAL tests. However, they can be used in a COMPUTE command to generate a calculated value that can be used in a WHERE TOTAL test.

Calculate Report-Level Average, Maximum, Minimum, and Count Values

```
operator.field
```

where:

operator

Can be one of the following prefix operators.

- **TOTAVE.** Calculates the average value of the field for the entire table.
- **TOTMAX.** Calculates the maximum value of the field for the entire table.
- **TOTMIN.** Calculates the minimum value of the field for the entire table.
- **TOTCNT.** Calculates the count of the field instances for the entire table.

field

Is a verb object or calculated value in the request.

Using Prefix Operators in a Heading

The following request uses prefix operators in the heading.

```
TABLE WFLITE
HEADING
"Heading Calculations:"
"Total:          <TOT.COGS_US"
"Count:                    <TOTCNT.COGS_US"
"Average:              <TOTAVE.COGS_US"
"Minimum:              <TOTMIN.COGS_US"
"Maximum:            <TOTMAX.COGS_US"
SUM COGS_US CNT.COGS_US AS Count AVE.COGS_US AS Average
MIN.COGS_US AS Minimum MAX.COGS_US AS Maximum
BY BUSINESS_REGION AS Region
BY PRODUCT_CATEGORY AS Category
WHERE BUSINESS_REGION NE 'Oceania'
ON TABLE SUBTOTAL COGS_US CNT.COGS_US AS Total
ON TABLE SET PAGE NOPAGE
```



```

ON TABLE SET SHOWBLANKS ON
ON TABLE SET STYLE *
type=report,grid=off, size=11,$
ENDSTYLE
END

```

The output is shown in the following image.

Heading Calculations:						
Total:		\$2,940,745.00				
Count:		9961				
Average:		\$295.23				
Minimum:		\$16.00				
Maximum:		\$9,750.00				
<u>Region</u>	<u>Category</u>	<u>Cost of Goods</u>	<u>Count</u>	<u>Average</u>	<u>Minimum</u>	<u>Maximum</u>
EMEA	Accessories	\$143,987.00	630	\$228.55	\$16.00	\$2,850.00
	Camcorder	\$187,000.00	611	\$306.06	\$60.00	\$8,610.00
	Computers	\$47,616.00	266	\$179.01	\$81.00	\$668.00
	Media Player	\$328,401.00	956	\$343.52	\$36.00	\$1,640.00
	Stereo Systems	\$361,756.00	1412	\$256.20	\$48.00	\$2,295.00
	Televisions	\$100,443.00	120	\$837.02	\$275.00	\$6,500.00
	Video Production	\$78,722.00	276	\$285.22	\$78.00	\$1,880.00
North America	Accessories	\$171,306.00	743	\$230.56	\$16.00	\$2,040.00
	Camcorder	\$242,967.00	692	\$351.11	\$60.00	\$6,000.00
	Computers	\$53,329.00	284	\$187.78	\$81.00	\$668.00
	Media Player	\$386,681.00	1118	\$345.87	\$36.00	\$1,600.00
	Stereo Systems	\$412,036.00	1636	\$251.86	\$48.00	\$2,700.00
	Televisions	\$101,212.00	121	\$836.46	\$275.00	\$6,500.00
	Video Production	\$89,489.00	325	\$275.35	\$78.00	\$1,410.00
South America	Accessories	\$25,723.00	103	\$249.74	\$16.00	\$1,470.00
	Camcorder	\$22,686.00	110	\$206.24	\$60.00	\$1,000.00
	Computers	\$7,845.00	47	\$166.91	\$81.00	\$501.00
	Media Player	\$60,183.00	161	\$373.81	\$36.00	\$1,480.00
	Stereo Systems	\$81,823.00	284	\$288.11	\$48.00	\$2,700.00
	Televisions	\$25,800.00	25	\$1,032.00	\$275.00	\$9,750.00
	Video Production	\$11,740.00	41	\$286.34	\$78.00	\$1,410.00
Total		\$2,940,745.00	9961			

Usage Notes for Report-Level Prefix Operators

- These operators can be used on a field in a heading or footing without being referenced in a display command in the request.
- They work in a heading or footing for real or virtual (DEFINE) fields. They work in a display command field list on real fields, virtual (DEFINE) fields, and calculated (COMPUTE) values that are calculated prior to their use in the request.
- They can be used in subheadings and subfootings to reference the total value for the entire report.

Viewing and Printing Report Output

Reports can be displayed on a terminal screen, sent to a printer, or routed to a file. FOCUS provides the HotScreen facility and the Terminal Operator Environment for displaying reports on a screen, and the OFFLINE command and the HotScreen facility for printing reports.

To display reports on a terminal screen, the value of the SET command PRINT parameter must be ONLINE, which is the default.

To send reports to a printer, the PRINT parameter must be set to OFFLINE.

Displaying Reports in HotScreen

By default, FOCUS reports are displayed in HotScreen, the FOCUS full-screen output facility that enables you to scroll within a report, store report data in a separate file, and print a report. Many of these functions can be invoked by using keys or by issuing commands at the command line. You can abbreviate a command name by using its shortest unique truncation.

Activate HotScreen

FOCUS automatically activates HotScreen every time you start a FOCUS session.

To check if HotScreen is activated, issue the following query at the FOCUS command prompt. The value of the SCREEN parameter should be ON:

```
? SET SCREEN
```

If you are using a full-screen terminal, you can activate HotScreen by issuing the following command at the FOCUS command prompt:

```
SET SCREEN=ON
```

This is the default setting for full-screen terminals.

Other acceptable values for SCREEN are OFF and PAPER.

- If SCREEN is set to OFF, then HotScreen is inactive. In this setting, FOCUS displays report output in line mode. It is the only setting for line terminals.
- If SCREEN is set to PAPER, HotScreen is active and FOCUS uses the settings for the LINES and PAPER parameters to set the format of the screen display. The default settings are LINES=57 and PAPER=66. See the *Developing Applications* manual for more information about the LINES and PAPER parameters.
- Use SET SCREEN=PAPER when you want the report display on your full-screen terminal to match the printed report.

i Note: You can reset the SCREEN parameter with either the SET SCREEN command or the ON TABLE SET SCREEN command in a report request.

Using PRINTPLUS

PRINTPLUS includes enhancements to the display alternatives offered by the FOCUS Report Writer. For example, you might wish to place a FOOTING after a SUBFOOT in your report. PRINTPLUS provides the flexibility to produce the exact report you desire.

The PRINTPLUS parameter must be set to ON to use the following TABLE capabilities:

- PAGE-BREAK is handled internally to provide the correct spacing of pages. For example, if a new report page is started and an instruction to skip a line at the top of the new page is encountered, FOCUS knows to suppress the blank line and start at the top of the page.
- NOSPLIT is handled internally. (Use NOSPLIT to force a break at a specific spot.)
- You can perform RECAPs in cases where pre-specified conditions are met.
- A Report SUBFOOT now prints above the footing instead of below it.
- Data displays correctly in subfoots when IF/WHERE TOTAL or BY HIGHEST is used.
- BY field actions are linked with BY field options so they appear on the same page. The footing no longer splits on two pages.
- Footings and Subfoots always appear on a page with at least one data item, and will

never be split between two pages.

- Printing beyond the length of the page no longer occurs.
- Splitting of fields linked by OVER onto separate pages no longer occurs.
- There is no reserved space for conditional output. The output page is fully used.
- The order of sort fields is no longer relevant.

i Note: PRINTPLUS is not supported for StyleSheets. A warning message is generated in this case.

Use PRINTPLUS

Issue the command

```
SET PRINTPLUS = {ON|OFF}
```

Using PRINTPLUS With SUBFOOT and FOOTING

With PRINTPLUS on, the SUBFOOT prints first, followed by the FOOTING.

```
SET PRINTPLUS = ON
TABLE FILE CAR
PRINT CAR MODEL
BY SEATS BY COUNTRY
IF COUNTRY EQ ENGLAND OR FRANCE OR ITALY
ON TABLE SUBFOOT
" "
" SUMMARY OF CARS IN COUNTRY BY SEATING CAPACITY"
FOOTING
" RELPMEK CAR SURVEY "
END
```

The output is:

SEATS	COUNTRY	CAR	MODEL
-----	-----	---	-----
2	ENGLAND	TRIUMPH	TR7
	ITALY	ALFA ROMEO	2000 GT VELOCE
		ALFA ROMEO	2000 SPIDER VELOCE
		MASERATI	DORA 2 DOOR
4	ENGLAND	JAGUAR	V12XKE AUTO
		JENSEN	INTERCEPTOR III
	ITALY	ALFA ROMEO	2000 4 DOOR BERLINA
5	ENGLAND	JAGUAR	XJ12L AUTO
	FRANCE	PEUGEOT	504 4 DOOR

SUMMARY OF CARS IN COUNTRY BY SEATING CAPACITY

RELPM EK CAR SURVEY

Accessing Help Information

To access help information about PF key assignments in HotScreen, press **PF1**:

KEYS: 1=HELP 2=FENC 3=END 4=OFFL 5=LOCA 6=SAVE 7=BACK 8=FORW 10=LEFT 11=RIGHT

To view additional information about PF keys, press **PF1** a second time.

To clear the Help window, press **PF1** a third time.

You can also issue the SET HOTMENU command to display the HotScreen PF key legend at the bottom of the HotScreen report. For more information about the SET HOTMENU command, see the *Developing Applications* manual.

Scrolling a Report

You can use HotScreen PF keys or commands to scroll within a report.

This section describes the keys and commands you use to scroll, save data, locate character strings, repeat commands, redisplay a report, preview a report, and display BY fields with panels.

Scrolling Forward

To scroll forward in a report one page at a time, press **PF8**. HotScreen displays the bottom two lines of the previous screen as the top two lines of the next screen.

When there are no more report lines, FOCUS displays the END-OF-REPORT message at the bottom of the screen. To clear this message and the end of the report, press **Enter**. HotScreen returns to the FOCUS command line.

You can also issue the following commands at the bottom of the screen to scroll forward through a report:

Command	Description
BOTTOM	Scrolls the display directly to the last page of the report.
NEXT <i>n</i>	Scrolls the display forward by the number of pages you specify.
FORW <i>n</i>	Like NEXT, scrolls the display forward the number of pages you specify.
DOWN <i>n</i>	Like NEXT and FORW, scrolls the display forward the number of pages you specify.

i **Note:** If omitted, *n* defaults to 1.

Scrolling Backward

To scroll backward from the bottom of a report, press **PF7**.

You can also use the following commands to scroll backward through the report:

Command	Description
TOP	Scrolls the display directly back to the first page of the report.
UP <i>n</i>	Scrolls the display back the number of pages you specify.
BACK <i>n</i>	Like UP, scrolls the display back the number of pages you specify.

i **Note:** If omitted, *n* defaults to 1.

Scrolling Horizontally

When a report exceeds the width of a screen, you can view it by scrolling horizontally to the left and to the right.

FOCUS displays the following symbol in the bottom-right corner of the screen when the report is too wide:

MORE =>

You can also have HotScreen scroll directly back to your first report screen.

- To scroll horizontally to the left one screen, press **PF10**. You can also issue:

LEFT *n*

where *n* is the number of characters. If *n* is omitted, it defaults to half of a screen.

- To scroll horizontally to the right one screen, press **PF11** or issue:

RIGHT *n*

where *n* is the number of characters. If *n* is omitted, it defaults to 4 characters.

If you wish to scroll horizontally from a particular column, move the cursor to that location and press **PF10** to scroll left or **PF11** to scroll right.

Scrolling From Fixed Columns (Fencing)

To help you view a wide report in HotScreen, you can hold the display of sort fields in the left-most columns of the screen while you scroll horizontally to the right to view the remaining columns.

To define a block of fixed columns, the steps are:

1. Scroll the display to the start of the first column to be held.
2. Press **PF2**.
3. Move the cursor to the end of the last column to be held.
4. Press **PF2** again.

Scrolling Report Headings

You can make report headings and footers scroll along with the report contents in your HotScreen report by using the SET BYSCROLL command. The headings and footers scroll along with data to avoid confusion in matching the data with a corresponding header or footer.

To scroll report headings along with data, the syntax is:

```
SET BYSCROLL = {ON|OFF}
```

where:

ON

Enables BYSCROLL.

OFF

Disables BYSCROLL. OFF is the default.

In order to use BYSCROLL, the text in the report must be longer than 80 characters, and BYPANEL must be set ON. With BYPANEL OFF, headings and footings do not scroll. Note that fencing is not supported while BYPANEL is on. To determine the setting of BYSCROLL, enter ? SET BYSCROLL.

Saving Selected Data

HotScreen also enables you to select and save data from a report request for use in subsequent requests. The steps are:

1. Position the cursor under the first character of the text to be saved.
2. Press **PF6**. FOCUS saves the text from that start character to the end of the line in a file with the file name SAVE. See [Saving and Reusing Your Report Output](#) for information about SAVE files.

Each time you repeat these steps, new text is appended to the SAVE file.

Locating Character Strings

To locate a character string in a report, the steps are:

1. Press **PF5**. FOCUS prompts for the string:

```
ENTER STRING TO LOCATE /
```

2. Type the string you want to locate and press **Enter**.

FOCUS searches from the current position forward. When it locates the string, the cursor is placed under the first occurrence of the string in the report. To locate additional instances of the string, press **Enter** for each instance. If the string is not found, a message is displayed at the bottom of the screen.

You can also issue the following command from the command line:

```
LOCATE/string
```

Repeating Commands

If you want to use a command repeatedly, issue it with a doubled first letter.

For example:

```
RRIGHT 5
```

After the command is executed, it remains on the command line and can be repeated by pressing **Enter**.

You can cancel a command implicitly, by using a key command, or explicitly, by tabbing the cursor down to the command line and overwriting it with another command or with spaces.

Redisplaying Reports

To redisplay reports immediately after you clear the last display, issue the command:

```
RETYPE
```

RETYPE only redisplay the report; the retrieval process is not repeated.

You can also use the RETYPE command to reformat specific fields in the report. The syntax is

```
RETYPE [field1/format1 ... fieldn/formatn]
```

where:

field1

Is a field name from the previous report request. It can be the full field name, alias, qualified field name, or unique truncation.

format1

Is the format of the field whose field type (D, I, P, F) is the same as the original field in the request. All formats are supported, except for alpha (A), text (TX), dates, and fields with date edit options.

When no arguments are provided, RETYPE redisplay the report. When one or more arguments are supplied, RETYPE redisplay the entire report, and reformats the specified fields to the new format.

i Note:

- RETYPE with a reformatted field does not recognize labels in FML.
- When reformatting a packed field, you may not change the number of places after the decimal point. For example, a P7 field can be redisplayed as P9 or P12.0C, but not as P9.2.
- You can save the internal matrix and issue a RETYPE later in the session if SAVEMATRIX is set to ON (see the *Developing Applications* manual).
- You can issue any number of RETYPE commands, one after the other:

```
TABLE FILE EMPLOYEE
.
.
.
END

RETYPE
RETYPE
```

Previewing Your Report

You can also preview the format of a report without actually accessing any data. The SET XRETRIEVAL command enables you to perform TABLE, TABLEF, or MATCH FILE requests and produce HOLD Master Files without processing the report. The syntax is

```
SET XRETRIEVAL = {OFF|ON}
```

where:

OFF

Specifies that no retrieval is to be performed.

ON

Specifies retrieval is to be performed. ON is the default.

SET XRETRIEVAL may also be issued from within a FOCUS request.

Displaying BY Fields With Panels

HotScreen also enables you to display BY fields in the left portion of each panel of multi-panel reports. BY fields are vertical sort fields (see Chapter 4, *Sorting Tabular Reports*). The non-BY fields are displayed on the right portion of the panel. BY paneling is also available for OFFLINE reports.

To enable the display of BY fields with panels, set the BYPANEL parameter to one of the following values before issuing the request or within the request (using the ON TABLE phrase):

Value	Description
ON	Displays all BY fields specified in the report on each panel, and prevents column splitting.
n	Is the number of BY fields to be displayed; <i>n</i> is less than or equal to the total number of BY fields, specified in the request, from the major sort (first BY field) down. This prevents column splitting. Column splitting occurs when a report column is too large to fit on the defined panel. By default, FOCUS splits the column, displaying as many characters as possible, and the remaining characters continue on the next panel.
0	Zero displays BY fields only on the first panel. This prevents column splitting.
OFF	Displays BY fields on the first panel only. Column splitting is permitted. This is the default.

In the following example, SET BYPANEL=ON displays the BY fields COUNTRY and CAR on each panel:

```

SET BYPANEL=ON
TABLE FILE CAR
PRINT SEG.LENGTH BY COUNTRY BY CAR
WHERE COUNTRY EQ 'ENGLAND'
END

```

The output is:

PAGE 1.1		LENGTH	WIDTH	HEIGHT	WEIGHT	WHEELBASE
COUNTRY	CAR					
ENGLAND	JAGUAR	190	66	48	3,435	105.0
		199	70	54	4,200	112.8
	JENSEN	188	69	53	4,000	105.0
	TRIUMPH	165	66	50	2,241	85.0
PAGE 1.2		FUEL_CAP	BHP	RPM	MPG	ACCEL
COUNTRY	CAR					
ENGLAND	JAGUAR	18.0	241	5750	16	7
		24.0	241	5750	9	9
	JENSEN	24.0	385	4700	11	8
	TRIUMPH	14.5	90	5000	25	0

BYPANEL Conditions

- In HotScreen, the panel width for the SET BYPANEL command is the physical screen width. The SET PANEL command is ignored.
- In OFFLINE reports, the SET PANEL command is respected when used with SET BYPANEL. If you choose to override the report width, define a panel large enough to enable the BYPANEL feature using the SET PANEL command. The panel size should accommodate all the BY fields in the request, plus one non-BY field. If the defined panel is too small, the BYPANEL feature is disabled for the request and you receive a FOCUS error message.
- In OFFLINE reports, the SET BYPANEL command only works for widths of up to 132 characters.
- When SET BYPANEL is specified, the maximum number of panels is 99. When SET BYPANEL is OFF, the maximum number of panels is 4.

- Setting SCREEN=PAPER respects the SET BYPANEL command.
- The BYPANEL command may truncate summary text.
- The BYPANEL = ON command may truncate heading text. The heading is repeated from the beginning on the panels which follow.
- FOCUS does not support non-default BYPANEL settings with the OVER phrase. A warning will be produced, and the report will be produced with the default BYPANEL=OFF setting.
- In a request with several display commands, the number of BY fields in the first display command determines the BY field count for the BYPANEL command.
- You may not use FOLD-LINE and IN to position columns with the BYPANEL command.
- You may not use BYPANEL with the GRAPH facility.

Scrolling by Columns of BY Fields

When a report is wider than the screen width and the SET COLUMNS command is specified, you can scroll columns using PF keys:

- To move to the right one column, press **PF10**.
- To move to the left one column, press **PF11**.
- To move up within the same column, press **PF7**.
- To move down within the same column, press **PF8**.

The SET COLUMNS Command

To enable column scrolling as described in this section, specify the SET COLUMNS command as ON. To turn column scrolling off, specify SET COLUMNS as OFF.

Note the following usage information:

- If you specify the panel feature (SET PANEL), the panel size must be greater than the screen width in order for you to perform column scrolling.
- You cannot control column scrolling from within a TABLE request using the ON TABLE SET command.

- Report output must extend beyond the screen for column scrolling to have an effect.
- The OVER formatting option is not supported.
- Column width is determined by either the column title or field format, whichever is larger.
- When COLUMNS and BYPANEL are both set to ON, column scrolling is not enabled.
- Heading and footing lines are not maintained across the report as you scroll.

Displaying Reports in the Panel Facility

The Panel facility enables you to view reports that are too wide to fit on a typical 80-character terminal screen by dividing the display into a maximum of four panels. Pages are automatically numbered with decimal notation indicating the panel number (for example, 1.1, 1.2, 1.3), so that the results can be easily referenced. When these pages are produced as hardcopy, the page numbers also help you place the panels side by side. This feature is also very useful for reports over the 132-character standard line printer width.

To panel your report, issue

```
SET PANEL=n
```

before a report request. *n* is the number of characters you want displayed in each panel. This number must be in the range of 40 to 130.

For example:

```
SET PANEL=73
TABLE FILE EMPLOYEE
.
.
.
END
```

However, if you did not issue the panel command and the request has already been executed, FOCUS automatically prompts you for a panel width:

```
REPORT WIDTH IS ### IT EXCEEDS TERMINAL PRINT LINE OF 130
TO PROCEED ENTER A PANEL WIDTH (40-130) OR 0 TO END =
```

At that point, you can either enter a number between 40 and 130, or enter 0 to end the report request.

**Note:**

- If the SET BYPANEL command is specified, the SET PANEL command is ignored for reports displayed in HotScreen, and the terminal screen can be divided into a maximum of 99 panels.
- The PANEL setting is ignored if StyleSheets are enabled.

Printing Reports

You can print reports by issuing a command or by pressing a function key while in HotScreen.

The OFFLINE Command

You can use the OFFLINE command to send reports directly to a printer or a file without first displaying them on the screen. Simply issue the command

```
OFFLINE
```

before a report request.

Generally, this directs all offline reports to the default output spool file. This file is assigned automatically when you enter FOCUS, and is in almost all cases a printer.

However, if you already issued the report request to be displayed online, you can still send its output to the printer simply by entering the following two commands at the FOCUS command prompt:

```
OFFLINE  
RETYPE
```

You can also direct report output to a printer from within a report request by using the ON TABLE command:

```
ON TABLE SET PRINT OFFLINE
```

You can use OFFLINE to send reports to a file by allocating the ddname OFFLINE to the desired file using the FOCUS DYNAM command. The DYNAM command is described in the *Overview and Operating Environments* manual.

You can reroute report output to your screen by issuing the following command at the FOCUS command prompt:

```
ONLINE
```

You can reroute it only for the current request by including an ON TABLE SET PRINT ONLINE command in the request. Be sure also to issue the following command to close any current spool file and enable you to allocate new ones:

```
OFFLINE CLOSE
```

Printing Reports in HotScreen

To send all or part of a report displayed in HotScreen to an OFFLINE output device, press **PF4**.

The following print menu is displayed at the bottom of the screen:

```
1-Print entire report 2-Print this page 3-Cancel 4-Hold
```

1. Reformats the report to current page settings and then sends the entire report to a printer.
2. Prints the report page displayed, as formatted on the terminal screen.
3. Removes the print menu.
4. Creates a HOLD file using the entire report. The Master and FOCTEMP files have the default name HOLD.

Press the desired number key (not function key) and then press **Enter**.

Displaying Reports in the Terminal Operator Environment

The FOCUS Terminal Operator Environment, discussed in the *Overview and Operating Environments* manual, provides a table window that displays the report of the most recently executed report request. This enables you to view the report again without resubmitting the request. Unlike the RETYPE command, the most recent report is available even if other commands have been issued after the request.

The Table window displays a TABLE report as soon as you have terminated the report in HotScreen. It holds up to the first 10 pages of report data. That is up to 200 lines that are up to a width of 130 characters.

 **Note:** The Table Window does not record TABLEF reports, offline reports, or reports issued while the FOCUS SET SCREEN command is set to OFF.

Sorting Tabular Reports

Sorting enables you to group or organize report information vertically and horizontally, in rows and columns, and specify a desired sequence of data items in the report.

Any field in the data source can be the sort field. If you wish, you can select several sort fields, nesting one within another. Sort fields appear only when their values change.

Sorting Tabular Reports Overview

You sort a report using vertical (BY) and horizontal (ACROSS) phrases:

- BY displays the sort field values vertically, creating rows. Vertical sort fields are displayed in the left-most columns of the report.
- ACROSS displays the sort field values horizontally, creating columns. Horizontal sort fields are displayed across the top of the report.
- BY and ACROSS phrases used in the same report create rows and columns, producing a grid or matrix.

A request can include up to 128 sort phrases consisting of any combination of BY and ACROSS phrases.

Additional sorting options include:

- Sorting from low to high values or from high to low values, and defining your own sorting sequence.
- Sorting based on case-sensitive or case-insensitive collation sequence.
- Leaving the value of the sort field out of the report.
- Grouping numeric data into tiles such as percentiles or deciles.
- Aggregating and sorting numeric columns simultaneously.
- Grouping numeric data into ranges.
- Ranking data, and selecting data based on rank.

Sorting and Displaying Data

There are two ways that you can sort information, depending on the type of display command you use:

- You can sort and display individual values of a field using the PRINT or LIST command.
- You can group and aggregate information. For example, you can show the number of field occurrences per sort value using the COUNT command, or summing the field values using the SUM command.

When you use the display commands PRINT and LIST, the report may generate several rows per sort value; specifically, one row for each occurrence of the display field. When you use the commands SUM and COUNT, the report generates one row for each unique set of sort values. For related information, see [Sorting With Multiple Display Commands](#).

For details on all display commands, see [Displaying Report Data](#).

Sorting Rows

You can sort report information vertically using the BY phrase. This creates rows in your report. You can include up to 128 sort phrases (BY phrases plus ACROSS phrases) per report request (127 if using PRINT or LIST display commands).

Sort fields appear when their value changes. However, you can display every sort value using the BYDISPLAY parameter. For an example, see [Controlling Display of Sort Field Values](#).

Sort by Rows

```
BY {HIGHEST|LOWEST} [n] sortfield [AS 'text']
```

where:

HIGHEST

Sorts in descending order.

LOWEST

Sorts in ascending order. LOWEST is the default value.

n

Specifies that only **n** sort field values are included in the report.

sortfield

Is the name of the sort field.

text

Is the column heading to use for the sort field column on the report output.

Usage Notes for Sorting Rows

- When using the display command LIST with a BY phrase, the LIST counter is reset to 1 each time the major sort value changes.
- The default sort sequence is low-to-high, with the following variations for different operating systems. In z/OS the sequence is a-z, A-Z, 0-9 for alphanumeric fields; 0-9 for numeric fields. In UNIX and Windows the sequence is 0-9, A-Z, a-z for alphanumeric fields; 0-9 for numeric. You can specify other sorting sequences, as described in [Specifying the Sort Order](#).
- You cannot use text fields as sort fields. Text fields are those described in the Master File with a FORMAT value of TX.
- You can use a temporary field created by a DEFINE command, or by the DEFINE attribute in a Master File, as a sort field. In order to use a temporary field created by a COMPUTE command as a sort field, you must use the BY TOTAL phrase instead of the BY phrase.
- If you specify several sort fields when reporting from a multi-path data source, all the sort fields must be in the same path.
- Sort phrases cannot contain format information for fields.

- Each sort field value appears only once in the report. For example, if there are six employees in the MIS department, a request that declares

```
PRINT LAST_NAME BY DEPARTMENT
```

prints MIS once, followed by six employee names. You can populate every vertical sort column cell with a value, even if the value is repeating, using the SET BYDISPLAY parameter. For details, see [Controlling Display of Sort Field Values](#).

Sorting Rows With BY

The following illustrates how to display all employee IDs by department.

```
TABLE FILE EMPLOYEE
PRINT EMP_ID
BY DEPARTMENT
END
```

The output displays a row for each EMP_ID in each department:

```
DEPARTMENT  EMP_ID
-----  -----
MIS          112847612
             117593129
             219984371
             326179357
             543729165
             818692173
PRODUCTION  071382660
             119265415
             119329144
             123764317
             126724188
             451123478
```

<u>DEPARTMENT</u>	<u>EMP_ID</u>
MIS	112847612
	117593129
	219984371
	326179357
	543729165
PRODUCTION	818692173
	071382660
	119265415
	119329144
	123764317
	126724188
	451123478

Using Multiple Vertical (BY) Sort Fields

You can organize information in a report by using more than one sort field. When you specify several sort fields, the sequence of the BY phrases determines the sort order. The first BY phrase sets the major sort break, the second BY phrase sets the second sort break, and so on. Each successive sort is nested within the previous one.

Sorting With Multiple Vertical (BY) Sort Fields

The following request uses multiple vertical (BY) sort fields.

```
TABLE FILE EMPLOYEE
PRINT CURR_SAL
BY DEPARTMENT BY LAST_NAME
WHERE CURR_SAL GT 21500
END
```

The output is:

<u>DEPARTMENT</u>	<u>LAST_NAME</u>	<u>CURR_SAL</u>
-----	-----	-----
MIS	BLACKWOOD	\$21,780.00
	CROSS	\$27,062.00
PRODUCTION	BANNING	\$29,700.00
	IRVING	\$26,862.00

Displaying a Row for Data Excluded by a Sort Phrase

In a sort phrase, you can restrict the number of sort values displayed. With the PLUS OTHERS phrase, you can aggregate all other values to a separate group and display this group as an additional report row.

Display Data Excluded by a Sort Phrase

```
[RANKED] BY {HIGHEST|LOWEST|TOP|BOTTOM} n srtfield [AS 'text']
           [PLUS OTHERS AS 'othertext']
           [IN-GROUPS-OF m1 [TOP n2]]
           [IN-RANGES-OF m3 [TOP n4]]
```

where:

LOWEST

Sorts in ascending order, beginning with the lowest value and continuing to the highest value (a-z, A-Z, 0-9 for alphanumeric fields; 0-9 for numeric fields). BOTTOM is a synonym for LOWEST.

HIGHEST

Sorts in descending order, beginning with the highest value and continuing to the lowest value. TOP is a synonym for HIGHEST.

n

Specifies that only *n* sort field values are included in the report.

srtfield

Is the name of the sort field.

text

Is the text to be used as the column heading for the sort field values.

othertext

Is the text to be used as the row title for the "others" grouping. This AS phrase must be the AS phrase immediately following the PLUS OTHERS phrase.

m1

Is the incremental value between sort field groups.

n2

Is an optional number that defines the highest group label to be included in the report.

m3

Is an integer greater than zero indicating the range by which sort field values are grouped.

n4

Is an optional number that defines the highest range label to be included in the report. The range is extended to include all data values higher than this value.

Usage Notes for PLUS OTHERS

- Alphanumeric group keys are not supported.
- Only one PLUS OTHERS phrase is supported in a request.
- In a request with multiple display commands, the BY field that has the PLUS OTHERS phrase must be the lowest level BY field in the request. If it is not, a message will display and the request will not be processed.
- The BY ROWS OVER, TILES, ACROSS, and BY TOTAL phrases are not supported with PLUS OTHERS.
- PLUS OTHERS is not supported in a MATCH FILE request. However, MORE in a TABLE request is supported.
- HOLD is supported for formats PDF, PS, HTML, DOC, and WP.

Displaying a Row Representing Sort Field Values Excluded by a Sort Phrase

The following request displays the top two ED_HRS values and aggregates the values not included in a row-labeled Others:

```
TABLE FILE EMPLOYEE
PRINT CURR_SAL LAST_NAME
  BY HIGHEST 2 ED_HRS
  PLUS OTHERS AS 'Others'
END
```

The output is:

ED_HRS	CURR_SAL	LAST_NAME
-----	-----	-----
75.00	\$21,780.00	BLACKWOOD
50.00	\$18,480.00	JONES
	\$16,100.00	MCKNIGHT
Others	\$165,924.00	

Displaying a Row Representing Data Not Included in Any Sort Field Grouping

The following request sorts by highest 2 ED_HRS and groups the sort field values by increments of 25 ED_HRS. Values that fall below the lowest group label are included in the Others category. All values above the top group label are included in the top group:

```
TABLE FILE EMPLOYEE
PRINT CURR_SAL LAST_NAME
  BY HIGHEST 2 ED_HRS
  PLUS OTHERS AS 'Others'
IN-GROUPS-OF 25 TOP 50
END
```

The output is:

ED_HRS	CURR_SAL	LAST_NAME
-----	-----	-----
50.00	\$18,480.00	JONES
	\$21,780.00	BLACKWOOD
	\$16,100.00	MCKNIGHT
25.00	\$11,000.00	STEVENS
	\$13,200.00	SMITH
	\$26,862.00	IRVING
	\$9,000.00	GREENSPAN
	\$27,062.00	CROSS
Others	\$78,800.00	

If the BY HIGHEST phrase is changed to BY LOWEST, all values above the top grouping (50 ED_HRS and above) are included in the Others category:

```
TABLE FILE EMPLOYEE
PRINT CURR_SAL LAST_NAME
  BY LOWEST 2 ED_HRS
  PLUS OTHERS AS 'Others'
IN-GROUPS-OF 25 TOP 50
END
```

The output is:

ED_HRS	CURR_SAL	LAST_NAME
-----	-----	-----
.00	\$9,500.00	SMITH
	\$29,700.00	BANNING
	\$21,120.00	ROMANS
	\$18,480.00	MCCOY
25.00	\$11,000.00	STEVENS
	\$13,200.00	SMITH
	\$26,862.00	IRVING
	\$9,000.00	GREENSPAN
	\$27,062.00	CROSS
Others	\$56,360.00	

Sorting Columns

You can sort report information horizontally using the ACROSS phrase. This creates columns in your report. The total number of ACROSS columns is equal to the total number of ACROSS sort field values multiplied by the total number of display fields.

A request can include up to 128 sort phrases consisting of any combination of BY and ACROSS phrases.

The maximum number of display fields your report can contain is determined by a combination of factors. In general, if a horizontal (ACROSS) sort field contains many data values, you may exceed the allowed width for reports, or create a report that is difficult to read. For details, see [Displaying Report Data](#).

You can produce column totals or summaries for ACROSS sort field values using ACROSS-TOTAL, SUBTOTAL, SUB-TOTAL, RECOMPUTE, and SUMMARIZE. For details, see [Including Totals and Subtotals](#).

Sort Columns

```
ACROSS sortfield
```

where:

sortfield

Is the name of the sort field.

Usage Notes for Sorting Columns

- You cannot use text fields as sort fields. Text fields are those described in the Master File with a FORMAT value of TX.
- You can use a temporary field created by a DEFINE command, or by the DEFINE attribute in a Master File, as a sort field. However, you cannot use a temporary field created by a COMPUTE command as a sort field. You can accomplish this using the BY TOTAL phrase or indirectly by first creating a HOLD file that includes the field, and then reporting from the HOLD file. HOLD files are described in [Saving and Reusing Your Report Output](#).
- For an ACROSS phrase, the SET SPACES parameter controls the distance between ACROSS sets. For more information, see Customizing Tabular Reports.
- If you specify several sort fields when reporting from a multipath data source, all the

sort fields must be in the same path.

- In styled output formats (PDF, HTML, DHTML, PPT, PPTX, and XLSX), the width of ACROSS titles and ACROSS values above the data columns is defined as the largest width of all data columns, and associated column titles, within the ACROSS groups. To change the size of the ACROSS groups, apply SQUEEZE, WRAP, or WIDTH definitions to the data columns within each group.
- Each sort field value is displayed only once in the report unless you change this default using the SET BYDISPLAY command. For example, if there are six employees in the MIS department, a report that declares

```
PRINT LAST_NAME ACROSS DEPARTMENT
```

prints MIS once, followed by six employee names.

Sorting Columns With ACROSS

The following illustrates how to show the total salary outlay for each department. This request is sorted horizontally with an ACROSS phrase.

```
TABLE FILE EMPLOYEE
SUM CURR_SAL ACROSS DEPARTMENT
END
```

The output is:

DEPARTMENT	
MIS	PRODUCTION
-----	-----
\$108,002.00	\$114,282.00

Notice that the horizontal sort displays a column for each sort field (department).

Controlling Display of an ACROSS Title for a Single Field

Using the SET ACRSVRBTITL command, you can control the display of an ACROSS column title in an ACROSS group. The behavior of the title is determined by the number of verb columns in the ACROSS group. The field count is affected by the following features, which add internal matrix columns to the report:

- Fields in a heading or footing.
- Fields whose display is suppressed with the NOPRINT phrase.
- Reformatted fields (which are normally counted twice).
- A COMPUTE command referencing multiple fields.

Control Display of an ACROSS Title for a Single Field

```
SET ACRSVRBTITL = {HIDEONE|ON|OFF}
ON TABLE SET ACRSVRBTITL {HIDEONE|ON|OFF}
```

where:

HIDEONE

Suppresses the title when there is only one display field, or there is only one display field and the request contains one or more of the features that add internal matrix columns to the report. This value is the default.

ON

Always displays the title even if there is only one display field.

OFF

Suppresses the title when there is only one display field. Displays the title when there is only one display field and the request contains one or more of the features that add internal matrix columns to the report. This is legacy behavior.

Displaying or Suppressing a Single ACROSS Column Title

The following request against the GGSALES data source has one display field, DOLLARS. The ACRSVRBTTITL parameter is OFF:

```
SET ACRSVRBTTITL=OFF
TABLE FILE GGSALES
SUM DOLLARS AS Sales
ACROSS REGION
ON TABLE SET PAGE NOPAGE
ON TABLE SET STYLE *
GRID=OFF,$
ENDSTYLE
END
```

On the output, there is no column title that tells what the number in each column represents:

Region	Northeast	Southeast	West
Midwest			
11514345	11494543	11781285	11674908

The following is the same request with ACRSVRBTTITL=ON:

```
SET ACRSVRBTTITL=ON
TABLE FILE GGSALES
SUM DOLLARS AS Sales
ACROSS REGION
ON TABLE SET PAGE NOPAGE
ON TABLE SET STYLE *
GRID=OFF,$
ENDSTYLE
END
```

On the output, the title Sales appears above each field value in the ACROSS group:

Region	Northeast	Southeast	West
Midwest			
11514345	11494543	11781285	11674908

Sales	Sales	Sales	Sales
11514345	11494543	11781285	11674908

Hiding an ACROSS Title With HIDEONE

The following request against the GGSales data source has a display field in the heading:

```
SET ACRSVRBTITL=OFF
TABLE FILE GGSales
HEADING
"Sales Report for <CATEGORY with ACRSVRBTITL=OFF"
" "
SUM DOLLARS AS Sales
BY CATEGORY
ACROSS REGION
WHERE CATEGORY EQ 'Food'
ON TABLE SET PAGE NOPAGE
END
```

With the setting ACRSVRBTITL=OFF, the field in the heading counts and the ACROSS title **Sales** is not suppressed:

```
Sales Report for Food with ACRSVRBTITL=OFF

          Region
Category  Midwest  Northeast  Southeast  West
          Sales    Sales      Sales      Sales
-----
Food      4404483    4445197    4308731    4204333
```

Changing ACRSVRBTITL to ON produces the same report:

```
Sales Report for Food with ACRSVRBTITL=ON

          Region
Category  Midwest  Northeast  Southeast  West
          Sales    Sales      Sales      Sales
-----
Food      4404483    4445197    4308731    4204333
```

Changing ACRSVRBTITL to HIDEONE suppresses the ACROSS title **Sales**:

Sales Report for Food with ACRSVRBTITL=HIDEONE

	Region			
Category	Midwest	Northeast	Southeast	West
Food	4404483	4445197	4308731	4204333

Displaying or Suppressing a Single ACROSS Column Title

The following request against the GGSALES data source has one display field, DOLLARS. The ACRSVRBTITL parameter is OFF:

```
SET ACRSVRBTITL=OFF
TABLE FILE GGSALES
SUM DOLLARS AS Sales
ACROSS REGION
ON TABLE SET PAGE NOPAGE
ON TABLE SET STYLE *
GRID=OFF,$
ENDSTYLE
END
```

On the output, there is no column title that tells what the number in each column represents:

Region			
Midwest	Northeast	Southeast	West
11514345	11494543	11781285	11674908

The following is the same request with ACRSVRBTITL=ON:

```
SET ACRSVRBTITL=ON
TABLE FILE GGSALES
SUM DOLLARS AS Sales
ACROSS REGION
ON TABLE SET PAGE NOPAGE
ON TABLE SET STYLE *
```

```

GRID=OFF,$
ENDSTYLE
END

```

On the output, the title Sales appears above each field value in the ACROSS group:

Region			
Midwest	Northeast	Southeast	West
Sales	Sales	Sales	Sales
11514345	11494543	11781285	11674908

Hiding an ACROSS Title With ACRSVRBTITL

The following request against the GGSALES data source has a display field in the heading:

```

SET ACRSVRBTITL=HIDEONE
TABLE FILE GGSALES
HEADING
"Sales Report for <CATEGORY with ACRSVRBTITL=HIDEONE"
" "
SUM DOLLARS AS Sales
BY CATEGORY
ACROSS REGION
WHERE CATEGORY EQ 'Food'
ON TABLE SET PAGE NOPAGE
ON TABLE SET ACROSSTITLE SIDE
ON TABLE SET ACROSSLINE SKIP
ON TABLE HOLD FORMAT HTML
ON TABLE SET STYLE *
TYPE=REPORT, GRID=OFF, FONT='ARIAL', SIZE=9, SQUEEZE=ON,$
TYPE=TITLE,JUSTIFY=LEFT,BACKCOLOR=RGB(102 102 102),COLOR=RGB(255 255
255),STYLE=BOLD,$
TYPE=HEADING, SIZE=11, STYLE=BOLD,JUSTIFY=CENTER, $
TYPE=ACROSSTITLE,STYLE=BOLD,$
TYPE=ACROSSVALUE,BACKCOLOR=RGB(218 225 232),$
END

```

Using the default value for ACRSVRBTITL, HIDEONE, suppresses the ACROSS title **Sales**, even though the heading displays a field value that adds a report column to the internal matrix.

The report output is shown in the following image:

Sales Report for Food with ACRSVRBTITL=HIDEONE				
Region	Midwest	Northeast	Southeast	West
Category				
Food	4338271	4379994	4308731	4202337

If you change the SUM command to the following:

```
SUM DOLLARS/D12CM
```

the field in the heading and the reformatted dollar sales values add report columns to the internal matrix, but the ACROSS title **Sales** is still suppressed.

The report output is shown in the following image:

Sales Report for Food with ACRSVRBTITL=HIDEONE				
Region	Midwest	Northeast	Southeast	West
Category				
Food	\$4,338,271	\$4,379,994	\$4,308,731	\$4,202,337

Using the ACRSVRBTITL value ON, without reformatting the dollar sales column, does not suppress the ACROSS title **Sales** because the heading displays a field value that adds a report column to the internal matrix.

The report output is shown in the following image:

Sales Report for Food with ACRSVRBTITL=ON				
Region	Midwest	Northeast	Southeast	West
Category	Sales	Sales	Sales	Sales
Food	4338271	4379994	4308731	4202337

If you change the SUM command to the following:

```
SUM DOLLARS/D12CMC
```

the field in the heading and the reformatted dollar sales values add report columns to the internal matrix, so the ACROSS title **Sales** is not suppressed.

The report output is shown in the following image:

Sales Report for Food with ACRSVRBTITL=ON				
Region	Midwest	Northeast	Southeast	West
Category	Sales	Sales	Sales	Sales
Food	\$4,338,271	\$4,379,994	\$4,308,731	\$4,202,337

With the setting ACRSVRBTITL=OFF, the field in the heading adds a report column to the internal matrix, and the ACROSS title **Sales** is not suppressed.

The report output is shown in the following image:

Sales Report for Food with ACRSVRBTITL=OFF				
Region	Midwest	Northeast	Southeast	West
Category	Sales	Sales	Sales	Sales
Food	4338271	4379994	4308731	4202337

If you change the SUM command to the following:

```
SUM DOLLARS/D12CM
```

the field in the heading and the reformatted dollar sales values add report columns to the internal matrix, and the ACROSS title **Sales** is not suppressed.

The report output is shown in the following image:

Sales Report for Food with ACRSVRBTITL=OFF				
Region	Midwest	Northeast	Southeast	West
Category	Sales	Sales	Sales	Sales
Food	\$4,338,271	\$4,379,994	\$4,308,731	\$4,202,337

Positioning ACROSS Titles on Report Output

In a report that uses the ACROSS sort phrase to sort values horizontally across the page, by default, two lines are generated on the report output for the ACROSS columns. The first line displays the name of the sort field (ACROSS title), and the second line displays the values for that sort field (ACROSS value). The ACROSS field name is left justified above the first ACROSS value.

If you want to display both the ACROSS title and the ACROSS values on one line in the PDF, HTML, or EXL2K report output, you can issue the SET ACROSSTITLE = SIDE command. This command places ACROSS titles to the left of the ACROSS values. By default, the titles are right justified in the space above the BY field titles. You can change the justification of the ACROSS title by adding the JUSTIFY attribute to the StyleSheet declaration for the ACROSSTITLE component. If there are no BY fields, the heading line that is created by default to display the ACROSS title will not be generated.

This feature is designed for use in requests that have both ACROSS fields and BY fields. For requests with ACROSS fields but no BY fields, the set command is ignored, and the ACROSS titles are not moved.

Note that for certain output formats, you can control whether column titles are underlined using the SET TITLELINE command. SET ACROSSLINE is a synonym for SET TITLELINE. For more information, see Customizing Tabular Reports.

Control the Position of ACROSS Field Names

```
SET ACROSSTITLE = {ABOVE|SIDE}
```

where:

ABOVE

Displays ACROSS titles above their ACROSS values. ABOVE is the default value.

SIDE

Displays ACROSS titles to the left of their ACROSS values, above the BY columns.

Usage Notes for SET ACROSSTITLE

- When the ACROSS value wraps, the ACROSS title aligns with the top line of the wrapped ACROSS values.
- The ACROSS title spans the width of the BY columns. If the ACROSS title value is larger than the width of the BY columns on the current page, the value is truncated. The first panel may have more BY fields than subsequent panels, if SET BYPANEL is set to a value smaller than the total number of BY fields.
- This setting will not create a new column within the report for the title placement.
 - If the request does not have any BY fields, the ACROSS title is not moved.
 - With BYPANEL=OFF, the ACROSS title is not displayed on subsequent panels.
- WRAP is not supported for ACROSSTITLE with SET ACROSSTITLE=SIDE.

Placing the ACROSS Title on the Same Line as the ACROSS Values

The following example against the GGSALES data source has two ACROSS sort fields, CATEGORY and PRODUCT. SET ACROSSTITLE=SIDE moves the ACROSS title to the left of the ACROSS values. With BYPANEL=ON the ACROSS titles are repeated in the same location on each subsequent panel.

```
SET ACROSSTITLE=SIDE
SET BYPANEL=ON
TABLE FILE GGSALES
SUM
    DOLLARS/I8M AS ''
BY REGION
BY ST
BY CITY
ACROSS CATEGORY
ACROSS PRODUCT
WHERE PRODUCT NE 'Capuccino';
ON TABLE SET PAGE-NUM ON
ON TABLE NOTOTAL
ON TABLE HOLD FORMAT PDF
ON TABLE SET HTMLCSS ON
```

```

ON TABLE SET STYLE *
    UNITS=IN,
    SQUEEZE=ON,
    ORIENTATION=PORTRAIT,
$
TYPE=REPORT,
    FONT='ARIAL',
    SIZE=10,
    BORDER=LIGHT,
$
TYPE=ACROSSVALUE,
    WRAP=ON,
$
ENDSTYLE
END

```

The ACROSS title *Category* displays to the left of the ACROSS values *Coffee*, *Food*, and *Gifts*. The ACROSS title *Product* displays to the left of the ACROSS values *Espresso*, *Latte*, *Biscotti*, and so on. The ACROSS titles are right-justified above the space occupied by the BY field names *Region*, *State*, and *City*. Notice that the ACROSS value *Croissant* wraps onto a second line, and the ACROSS title is aligned with the top line. The following shows panel 1:

			Coffee		Food			Gifts
Product			Espresso	Latte	Biscotti	Croissant	Scone	Coffee Grinder
Region	State	City						
Midwest	IL	Chicago	\$420,439	\$978,340	\$378,412	\$549,366	\$595,069	\$233,292
	MO	St. Louis	\$419,143	\$966,981	\$368,077	\$613,871	\$481,953	\$181,570
	TX	Houston	\$455,365	\$938,245	\$345,238	\$587,887	\$418,398	\$204,292
Northeast	CT	New Haven	\$279,373	\$926,052	\$589,355	\$551,489	\$283,874	\$169,908
	MA	Boston	\$248,356	\$917,737	\$570,391	\$497,234	\$332,486	\$177,940
	NY	New York	\$322,378	\$928,026	\$642,259	\$622,095	\$290,811	\$161,352
Southeast	FL	Orlando	\$256,539	\$889,887	\$511,597	\$602,076	\$311,836	\$217,204
	GA	Atlanta	\$317,389	\$907,365	\$555,231	\$661,806	\$273,420	\$217,254
	TN	Memphis	\$279,644	\$820,584	\$438,889	\$638,477	\$315,399	\$171,319
West	CA	Los Angeles	\$267,809	\$809,647	\$266,030	\$800,084	\$315,584	\$214,557
		San Francisco	\$338,270	\$935,862	\$269,518	\$824,457	\$292,839	\$187,123
	WA	Seattle	\$301,538	\$924,896	\$328,320	\$801,060	\$304,445	\$201,756

The following shows panel 2:

PAGE 1.2

Category			Gifts		
Product			Coffee Pot	Mug	Thermos
Region	State	City			
Midwest	IL	Chicago	\$204,828	\$376,754	\$187,901
	MO	St. Louis	\$190,153	\$343,852	\$195,686
	TX	Houston	\$204,897	\$366,337	\$194,319
Northeast	CT	New Haven	\$208,209	\$392,967	\$221,827
	MA	Boston	\$184,119	\$401,944	\$203,435
	NY	New York	\$198,452	\$349,300	\$178,836
Southeast	FL	Orlando	\$212,057	\$409,466	\$195,526
	GA	Atlanta	\$232,552	\$355,447	\$227,482
	TN	Memphis	\$200,694	\$337,790	\$209,449
West	CA	Los Angeles	\$202,285	\$381,926	\$207,613
		San Francisco	\$197,845	\$379,399	\$165,115
	WA	Seattle	\$213,494	\$427,339	\$198,640

ACROSS Title Spacing

The following example against the GGSALES data source has two BY fields and two ACROSS fields. This example does not set borders on and does not enable wrapping of the ACROSS values. SET ACROSSTITLE=SIDE moves the ACROSS title to the left of the ACROSS values. The SET BYPANEL=1 command repeats only the first BY field on the second panel. To prevent the ACROSS titles from being truncated to fit above the BY field on the second panel, the first BY field has an AS name that is longer than the default name:

```
SET ACROSSTITLE=SIDE
SET BYPANEL=1
TABLE FILE GGSALES
SUM
    DOLLARS/I8M AS ''
BY ST AS 'State Code'
BY CITY
ACROSS CATEGORY AS 'Categories'
ACROSS PRODUCT AS 'Products'
WHERE PRODUCT NE 'Capuccino';
ON TABLE SET PAGE-NUM ON
ON TABLE NOTOTAL
ON TABLE HOLD FORMAT PDF
ON TABLE SET HTMLCSS ON
```

```

ON TABLE SET STYLE *
  UNITS=IN,
  SQUEEZE=ON,
  ORIENTATION=PORTRAIT,
$
TYPE=REPORT,
  FONT='ARIAL',
  SIZE=10,
$
ENDSTYLE
END

```

The first panel follows:

PAGE 1.1						
State Code	Categories City	Coffee Espresso	Latte	Food Biscotti	Croissant	Score
CA	Los Angeles	\$267,809	\$809,647	\$266,030	\$800,084	\$315,584
	San Francisco	\$338,270	\$935,862	\$269,518	\$824,457	\$292,839
CT	New Haven	\$279,373	\$926,052	\$589,355	\$551,489	\$283,874
FL	Orlando	\$256,539	\$889,887	\$511,597	\$602,076	\$311,836
GA	Atlanta	\$317,389	\$907,365	\$555,231	\$661,806	\$273,420
IL	Chicago	\$420,439	\$978,340	\$378,412	\$549,366	\$595,069
MA	Boston	\$248,356	\$917,737	\$570,391	\$497,234	\$332,486
MO	St. Louis	\$419,143	\$966,981	\$368,077	\$613,871	\$481,953
NY	New York	\$322,378	\$928,026	\$642,259	\$622,095	\$290,811
TN	Memphis	\$279,644	\$820,584	\$438,889	\$638,477	\$315,399
TX	Houston	\$455,365	\$938,245	\$345,238	\$587,887	\$418,398
WA	Seattle	\$301,538	\$924,896	\$328,320	\$801,060	\$304,445

Because of the SET BYPANEL=1 command, the space available above the BY fields on the second panel is smaller than the space on the initial panel. The AS name **State Code** adds space for the ACROSS titles, so the titles are not truncated on the second panel:

PAGE 1.2				
Categories Products State Code	Gifts Coffee Grinder	Coffee Pot	Mug	Thermos
CA	\$214,557	\$202,285	\$381,926	\$207,613
	\$187,123	\$197,845	\$379,399	\$165,115
CT	\$169,908	\$208,209	\$392,967	\$221,827
FL	\$217,204	\$212,057	\$409,466	\$195,526
GA	\$217,254	\$232,552	\$355,447	\$227,482
IL	\$233,292	\$204,828	\$376,754	\$187,901
MA	\$177,940	\$184,119	\$401,944	\$203,435
MO	\$181,570	\$190,153	\$343,852	\$195,686
NY	\$161,352	\$198,452	\$349,300	\$178,836
TN	\$171,319	\$200,694	\$337,790	\$209,449
TX	\$204,292	\$204,897	\$366,337	\$194,319
WA	\$201,756	\$213,494	\$427,339	\$198,640

Specifying Background Color for ACROSS Values With ACROSSTITLE=SIDE

The following request against the GGSales data source places the ACROSS titles next to the ACROSS values and sets matching styling of font color and bgcolor for the ACROSSTITLES, ACROSSVALUES, and column titles to white text on grey background color.

```

SET ACROSSTITLE=SIDE
TABLE FILE GGSales
SUM DOLLARS/I8M AS ''
BY REGION
BY ST
BY CITY
ACROSS CATEGORY
ACROSS PRODUCT
WHERE CATEGORY EQ 'Coffee' OR 'Food';
ON TABLE SET PAGE-NUM NOPAGE
ON TABLE NOTOTAL
ON TABLE HOLD FORMAT HTML
ON TABLE SET HTMLCSS ON
ON TABLE SET STYLE *
SQUEEZE=ON,UNITS=IN,ORIENTATION=PORTRAIT,$
TYPE=REPORT, FONT='ARIAL', SIZE=10, BORDER=LIGHT,$
TYPE=ACROSSTITLE, COLOR=WHITE, BACKCOLOR=GREY,$

```

```
TYPE=ACROSSVALUE,COLOR=WHITE, BACKCOLOR=GREY,$
TYPE=TITLE,COLOR=WHITE, BACKCOLOR=GREY,$
ENDSTYLE
END
```

The output has a grey background color and white text for the ACROSS titles, ACROSS values, and column titles.

Category			Coffee			Food		
Product			Capuccino	Espresso	Latte	Biscotti	Croissant	Scone
Region	State	City						
Midwest	IL	Chicago	.	\$420,439	\$978,340	\$378,412	\$549,366	\$595,069
	MO	St. Louis	.	\$419,143	\$966,981	\$368,077	\$613,871	\$481,953
	TX	Houston	.	\$455,365	\$938,245	\$345,238	\$587,887	\$418,398
Northeast	CT	New Haven	\$158,995	\$279,373	\$926,052	\$589,355	\$551,489	\$283,874
	MA	Boston	\$174,344	\$248,356	\$917,737	\$570,391	\$497,234	\$332,486
	NY	New York	\$208,756	\$322,378	\$928,026	\$642,259	\$622,095	\$290,811
Southeast	FL	Orlando	\$317,027	\$256,539	\$889,887	\$511,597	\$602,076	\$311,836
	GA	Atlanta	\$352,161	\$317,389	\$907,365	\$555,231	\$661,806	\$273,420
	TN	Memphis	\$274,812	\$279,644	\$820,584	\$438,889	\$638,477	\$315,399
West	CA	Los Angeles	\$306,468	\$267,809	\$809,647	\$266,030	\$800,084	\$315,584
		San Francisco	\$279,830	\$338,270	\$935,862	\$269,518	\$824,457	\$292,839
	WA	Seattle	\$309,197	\$301,538	\$924,896	\$328,320	\$801,060	\$304,445

Using Multiple Horizontal (ACROSS) Sort Fields

You can sort a report using more than one sort field. When several sort fields are used, the ACROSS phrase order determines the sorting order. The first ACROSS phrase sets the first sort break, the second ACROSS phrase sets the second sort break, and so on. Each successive sort is nested within the previous one.

Sorting With Multiple Horizontal (ACROSS) Phrases

The following request sorts the sum of current salaries, first by department and then by job code.

```
TABLE FILE EMPLOYEE
SUM CURR_SAL
ACROSS DEPARTMENT ACROSS CURR_JOBCODE
WHERE CURR_SAL GT 21500
END
```

The output is:

DEPARTMENT	MIS		PRODUCTION	
CURR_JOBCODE	A17	B04	A15	A17

	\$27,062.00	\$21,780.00	\$26,862.00	\$29,700.00

Collapsing PRINT With ACROSS

The PRINT command generates a report that has a single line for each record retrieved from the data source after screening out those that fail IF or WHERE tests. When PRINT is used in conjunction with an ACROSS phrase, many of the generated columns may be empty. Those columns display the missing data symbol.

To avoid printing such a sparse report, you can use the SET ACROSSPRT command to compress the lines in the report. The number of lines is reduced within each sort group by swapping non-missing values from lower lines with missing values from higher lines, and then eliminating any lines whose columns all have missing values.

Because data may be moved to different report lines, row-based calculations such as ROW-TOTAL and ACROSS-TOTAL in a compressed report are different from those in a non-compressed report. Column calculations are not affected by compressing the report lines.

Compress Report Lines

```
SET ACROSSPRT = {NORMAL | COMPRESS}
```

```
ON TABLE SET ACROSSPRT{NORMAL | COMPRESS}
```

where:

NORMAL

Does not compress report lines. NORMAL is the default value.

COMPRESS

Compresses report lines by promoting data values up to replace missing values within a sort group.

Usage Notes for SET ACROSSPRT

- Compression applies only to ACROSS fields, including ACROSS ... COLUMNS. It has no effect on BY fields.
- The only data values that are subject to compression are true missing values. If the value of the stored data is either 0 or blank and the metadata indicates that MISSING is ON, that value is not subject to compression.

Compressing Report Output With SET ACROSSPRT

The following request against the GGSALES data source prints unit sales by product across region:

```
TABLE FILE GGSALES
PRINT UNITS/I5
BY PRODUCT
ACROSS REGION
WHERE DATE FROM '19971201' TO '19971231';
WHERE PRODUCT EQ 'Capuccino' OR 'Espresso';
ON TABLE SET ACROSSPRT NORMAL
ON TABLE SET PAGE NOPAGE
END
```

Each line of the report represents one sale in one region, so at most one column in each row has a non-missing value when ACROSSPRT is set to NORMAL.

	Region			
	Midwest	Northeast	Southeast	West
Product	Unit Sales	Unit Sales	Unit Sales	Unit Sales

Capuccino	.	936	.	.
	.	116	.	.
	.	136	.	.
	.	.	1616	.
	.	.	1118	.
	.	.	774	.
	.	.	.	1696
	.	.	.	1519
	.	.	.	836
Espresso	1333	.	.	.
	280	.	.	.
	139	.	.	.
	.	1363	.	.
	.	634	.	.
	.	406	.	.
	.	.	1028	.
	.	.	1014	.
	.	.	885	.
	.	.	.	1782
	.	.	.	1399
	.	.	.	551

Setting ACROSSPRT to COMPRESS promotes non-missing values up to replace missing values within the same BY group and then eliminates lines consisting of all missing values.

```
TABLE FILE GGSales
PRINT UNITS/I5
BY PRODUCT
ACROSS REGION
WHERE DATE FROM '19971201' TO '19971231';
WHERE PRODUCT EQ 'Capuccino' OR 'Espresso';
ON TABLE SET ACROSSPRT COMPRESS
ON TABLE SET PAGE NOPAGE
END
```

The output is:

Product	Region			
	Midwest Unit Sales	Northeast Unit Sales	Southeast Unit Sales	West Unit Sales
Capuccino	.	936	1616	1696
	.	116	1118	1519
	.	136	774	836

Espresso	1333	1363	1028	1782
	280	634	1014	1399
	139	406	885	551

Hiding Null Columns in ACROSS Groups

Report requests that use the ACROSS sort phrase generate a group of columns (one for each display field in the request) under each value of the ACROSS field. In many cases, some of these columns have only missing or null values. You can use the HIDE NULLACRS parameter to hide the display of ACROSS groups containing only null columns in styled output formats. If there is a BY field with a PAGE-BREAK option, columns are hidden on each page of output generated by that PAGE-BREAK option. If the request contains no BY page breaks, ACROSS groups that are missing for the entire report are hidden.

Hiding null ACROSS columns is supported for all styled output formats except for the EXL2K PIVOT and EXL2K FORMULA options.

Hide Null ACROSS Columns

```
SET HIDE NULLACRS = {ON|OFF}
```

```
ON TABLE SET HIDE NULLACRS {ON|OFF}
```

where:

ON

Hides columns with missing data in ACROSS groups within a BY-generated page break.

OFF

Does not hide columns. OFF is the default value.

Usage Notes for Hiding Null Columns Within ACROSS Groups

- Aligning items in headings with the associated data columns (HEADALIGN) is not supported for ACROSS reports.
- Hiding ACROSS columns will not affect items placed in heading elements with spot markers or explicit positioning. This means that after ACROSS group columns are hidden, items may align with the ACROSS columns differently than expected.

Features Not Supported For Hiding Null ACROSS Columns

- EXL2K FORMULA.
- EXL2K PIVOT.
- OVER.
- HIDENULLACRS is only supported with page breaks specified in ON **byfieldname** PAGE-BREAK phrases or BY **fieldname** PAGE-BREAK phrases. It is not supported with:
 - BY **field** ROWS **value** OVER.
 - FML FOR fields (FOR **fieldvalue** OVER PAGE-BREAK).

Hiding ACROSS Groups and Columns Within BY Page Breaks

Hiding null columns is most useful when a BY sort field has the PAGE-BREAK option, either on the BY phrase itself or in an ON phrase. The change in value of the BY field determines when a page break is generated for that BY field. The change in BY field value defines the limits within which the ACROSS columns will be hidden, even if the BY field value spans multiple physical pages.

There is no way to specify a particular BY field with this setting, so if the request has multiple BY fields with page breaks, the setting applies to all of them. If there are no BY fields with page breaks, an ACROSS column must be missing for the entire report in order to be hidden.

The entire ACROSS group will be hidden either when the ACROSS value is missing or when all of the rows for all of the display columns under that ACROSS value contain null or missing values within the given BY field value.

The set of pages generated for a BY field value with a page break will be hidden if all ACROSS groups within that BY field value are hidden.

When columns are removed from a page or a panel, the existing columns are resituated to fill the missing space.

Hiding Null ACROSS Groups

The following request against the GGSALES data source has a page break on the BY field named REGION and an ACROSS phrase on the CITY field. The display fields in each ACROSS group are UNITS and DOLLARS:

```
SET HIDENULLACRS=OFF
TABLE FILE GGSALES
SUM UNITS DOLLARS
BY REGION PAGE-BREAK
BY ST
ACROSS CITY
WHERE CITY LE 'Memphis'
ON TABLE SET HTMLCSS ON
ON TABLE HOLD FORMAT HTML
ON TABLE SET STYLE *
TYPE=REPORT, FONT=ARIAL, SIZE=9,$
ENDSTYLE
END
```

With SET HIDENULLACRS=OFF, all columns display:

PAGE 1													
City													
Atlanta Boston Chicago Houston Los Angeles Memphis													
Region	State	Unit Sales	Dollar Sales	Unit Sales	Dollar Sales	Unit Sales	Dollar Sales	Unit Sales	Dollar Sales	Unit Sales	Dollar Sales	Unit Sales	Dollar Sales
Midwest	IL	307581	3924401
	TX	299737	3714978
PAGE 2													
City													
Atlanta Boston Chicago Houston Los Angeles Memphis													
Region	State	Unit Sales	Dollar Sales	Unit Sales	Dollar Sales	Unit Sales	Dollar Sales	Unit Sales	Dollar Sales	Unit Sales	Dollar Sales	Unit Sales	Dollar Sales
Northeast	MA	.	.	301909	3707986
PAGE 3													
City													
Atlanta Boston Chicago Houston Los Angeles Memphis													
Region	State	Unit Sales	Dollar Sales	Unit Sales	Dollar Sales	Unit Sales	Dollar Sales	Unit Sales	Dollar Sales	Unit Sales	Dollar Sales	Unit Sales	Dollar Sales
Southeast	GA	330283	4100107
	TN	294647	3687057
PAGE 4													
City													
Atlanta Boston Chicago Houston Los Angeles Memphis													
Region	State	Unit Sales	Dollar Sales	Unit Sales	Dollar Sales	Unit Sales	Dollar Sales	Unit Sales	Dollar Sales	Unit Sales	Dollar Sales	Unit Sales	Dollar Sales
West	CA	298070	3772003	.	.

Running the request with SET HIDE NULLACRS=ON eliminates the ACROSS groups for cities with missing data within each region. For example, the Midwest region has no columns for Atlanta or Boston:

PAGE 1					
		City			
		Chicago		Houston	
Region	State	Unit Sales	Dollar Sales	Unit Sales	Dollar Sales
Midwest	IL	307581	3924401	.	.
	TX	.	.	299737	3714978
PAGE 2					
		City			
		Boston			
Region	State	Unit Sales	Dollar Sales		
Northeast	MA	301909	3707986		
PAGE 3					
		City			
		Atlanta		Memphis	
Region	State	Unit Sales	Dollar Sales	Unit Sales	Dollar Sales
Southeast	GA	330283	4100107	.	.
	TN	.	.	294647	3687057
PAGE 4					
		City			
		Los Angeles			
Region	State	Unit Sales	Dollar Sales		
West	CA	298070	3772003		

Hiding Columns Within ACROSS Groups

In the following request against the GGSales data source, REGION is a BY field with a PAGE-BREAK, and PRODUCT is the ACROSS field. The DEFINE command creates a field named SHOWDOLLARS that has missing values for the Espresso column within the ACROSS group Coffee:

```
SET HIDENULLACRS=OFF
SET BYPANEL=2
DEFINE FILE GGSales
SHOWDOLLARS/I8M MISSING ON = IF (PRODUCT EQ 'Espresso') THEN MISSING
ELSE DOLLARS;
END
TABLE FILE GGSales
HEADING
```

```
"Page <TABPAGENO "  
SUM SHOWDOLLARS AS ''  
BY REGION  
BY ST  
BY CITY  
ACROSS PRODUCT  
WHERE REGION EQ 'Midwest' OR 'Northeast'  
WHERE CATEGORY EQ 'Coffee';  
ON REGION PAGE-BREAK  
ON TABLE SET PAGE-NUM ON  
ON TABLE NOTOTAL  
ON TABLE SET HTMLCSS ON  
ON TABLE HOLD FORMAT HTML  
ON TABLE SET STYLE *  
    UNITS=IN,  
    SQUEEZE=ON,  
    ORIENTATION=PORTRAIT,  
$  
TYPE=REPORT,  
    GRID=OFF,  
    FONT='ARIAL',  
    SIZE=9,  
$  
ENDSTYLE  
END
```

Running the request with SET HIDENULLACRS=OFF displays the Espresso column and any other column containing missing values within the Coffee group:

Page 1			Product	
Region	State	City	Capuccino	Espresso Latte
Midwest	IL	Chicago	.	.\$978,340
	MO	St. Louis	.	.\$966,981
	TX	Houston	.	.\$938,245

Page 2			Product	
Region	State	City	Capuccino	Espresso Latte
Northeast	CT	New Haven	\$158,995	.\$926,052
	MA	Boston	\$174,344	.\$917,737
	NY	New York	\$208,756	.\$928,026

Running the request with SET HIDENULLACRS=ON hides columns with missing data within each region. On page 1 (Midwest), both the Capuccino and Espresso columns are hidden, while on page 2 (Northeast), only the Espresso column is hidden:

Page 1			
Region	State	City	Product Latte
Midwest	IL	Chicago	\$978,340
	MO	St. Louis	\$966,981
	TX	Houston	\$938,245

Page 2				
Region	State	City	Product Capuccino Latte	
Northeast	CT	New Haven	\$158,995	\$926,052
	MA	Boston	\$174,344	\$917,737
	NY	New York	\$208,756	\$928,026

Hiding Null Columns With Multiple ACROSS Fields

The following request against the GGSales data source has two ACROSS fields, PRODUCT and CATEGORY. The BY field with the page break is REGION. The DEFINE command creates a field named SHOWDOLLARS that has missing values for the Espresso column within the ACROSS group **Coffee** and for the entire ACROSS group **Gifts**.

```

SET HIDE NULLACRS=OFF
DEFINE FILE GGSales
SHOWDOLLARS/I8M MISSING ON = IF (PRODUCT EQ 'Espresso' OR
    CATEGORY EQ 'Gifts') THEN MISSING ELSE DOLLARS;
END
TABLE FILE GGSales
SUM SHOWDOLLARS AS ''
BY REGION
BY ST
BY CITY
ACROSS CATEGORY
ACROSS PRODUCT
WHERE REGION EQ 'Midwest' OR 'Northeast'

```

```

ON REGION PAGE-BREAK
HEADING
"Page <TABPAGENO /<TABLASTPAGE "
ON TABLE SET PAGE-NUM OFF
ON TABLE SET BYPANEL ON
ON TABLE NOTOTAL
ON TABLE HOLD FORMAT HTML
ON TABLE SET HTMLCSS ON
ON TABLE SET STYLE *
    UNITS=IN,
    PAGESIZE='Letter',
    SQUEEZE=ON,
    ORIENTATION=PORTRAIT,
$
TYPE=REPORT,
    HEADPANEL=ON,
    GRID=OFF,
    FONT='ARIAL',
    SIZE=8,
$
ENDSTYLE
END
    
```

Running the request with SET HIDE NULLACRS=OFF displays all of the columns:

Page 1 /2												
			Category			Food			Gifts			
			Coffee									
			Product									
			Capuccino	Espresso	Latte	Biscotti	Croissant	Scone	Coffee Grinder	Coffee Pot	Mug	Thermos
Region	State	City										
Midwest	IL	Chicago	.	.	\$978,340	\$378,412	\$549,366	\$595,069
	MO	St. Louis	.	.	\$966,981	\$368,077	\$613,871	\$481,953
	TX	Houston	.	.	\$938,245	\$345,238	\$587,887	\$418,398
Page 2 /2												
			Category			Food			Gifts			
			Coffee									
			Product									
			Capuccino	Espresso	Latte	Biscotti	Croissant	Scone	Coffee Grinder	Coffee Pot	Mug	Thermos
Region	State	City										
Northeast	CT	New Haven	\$158,995	.	\$926,052	\$589,355	\$551,489	\$283,874
	MA	Boston	\$174,344	.	\$917,737	\$570,391	\$497,234	\$332,486
	NY	New York	\$208,756	.	\$928,026	\$642,259	\$622,095	\$290,811

Running the request with SET HIDE NULLACRS=ON hides the Espresso product and the entire Gifts category within each region. On page 1 (Midwest), the Gifts group and the

Espresso and Capuccino columns are hidden, while on page 2 (Northeast), the Gifts group and the Espresso column are hidden:

Page 1 /2							
Region	State	City	Category			Score	
			Coffee Product	Food			
			Latte	Biscotti	Croissant		
Midwest	IL	Chicago	\$978,340	\$378,412	\$549,366	\$595,069	
	MO	St. Louis	\$966,981	\$368,077	\$613,871	\$481,953	
	TX	Houston	\$938,245	\$345,238	\$587,887	\$418,398	
Page 2 /2							
Region	State	City	Category			Score	
			Coffee Product	Food			
			Capuccino	Latte	Biscotti	Croissant	
Northeast	CT	New Haven	\$158,995	\$926,052	\$589,355	\$551,489	\$283,874
	MA	Boston	\$174,344	\$917,737	\$570,391	\$497,234	\$332,486
	NY	New York	\$208,756	\$928,026	\$642,259	\$622,095	\$290,811

Generating Summary Lines and Hiding Null ACROSS Columns

If an entire ACROSS group is hidden, so are the totals generated for the associated BY field value. If any of the columns for the ACROSS value contain non-missing data, the ACROSS group will display with the non-missing columns.

Summary elements remain tied to their ACROSS group columns. If an ACROSS group is hidden, the associated summary value will be hidden, and subsequent values will realign with their ACROSS columns.

Summary lines generated at BY field breaks display at the end of the final page for that BY field value. All ACROSS groups that contain any non-null data within the entire BY value (even if they were hidden on some pages within the BY value) will display on the summary lines so that associated summary values can be displayed.

Grand totals can contain ACROSS columns that have been hidden on some pages within a BY field value. Therefore, they are always placed on a new page and presented for all ACROSS groups and columns that are displayed on any page within the report, regardless of what was hidden on other pages.

Summary lines defined for BY fields outside of the innermost BY page break may also contain ACROSS columns that have been hidden for some of the internal BY fields. For this reason, these summary lines will always present all available ACROSS columns and will be presented on a new page.

All totals calculated in columns (ACROSSTOTAL, ROWTOTAL) will be hidden if all of the column totals are missing.

Generating Column Totals and Hiding Null ACROSS Columns

In the following request against the GGSALES data source, REGION is a BY field with a PAGE-BREAK, and PRODUCT is the ACROSS field. The DEFINE command creates a field named SHOWDOLLARS that has missing values for the Espresso column within the ACROSS group **Coffee**. Column totals are generated at the end of the report:

```
SET HIDENULLACRS=ON
DEFINE FILE GGSALES
SHOWDOLLARS/I8M MISSING ON = IF (PRODUCT EQ 'Espresso') THEN MISSING
ELSE DOLLARS;
END
TABLE FILE GGSALES
SUM SHOWDOLLARS AS ''
BY REGION
BY ST
BY CITY
ACROSS PRODUCT
ON REGION PAGE-BREAK
HEADING
"Page <TABPAGENO /<TABLASTPAGE "
WHERE CATEGORY EQ 'Coffee';
ON TABLE SET PAGE-NUM OFF
ON TABLE SET BYPANEL ON
ON TABLE COLUMN-TOTAL AS 'TOTAL'
ON TABLE HOLD FORMAT HTML
ON TABLE SET HTMLCSS ON
ON TABLE SET STYLE *
```

```

        UNITS=IN,
        PAGESIZE='Letter',
        SQUEEZE=ON,
        ORIENTATION=PORTRAIT,
    $
    TYPE=REPORT,
        HEADPANEL=ON,
        GRID=OFF,
        FONT='ARIAL',
        SIZE=9,
    $
    ENDSTYLE
    END
    
```

Running the request hides the null columns within each REGION page break and generates a separate page for the column totals.

The following shows pages one through three. On page 1, the Espresso and Capuccino columns are hidden. On pages 2 and 3, the Espresso column is hidden:

The following shows pages four and five. On page 4, the Espresso column is hidden. Page 5 is the totals page. The Espresso column is hidden since it was hidden on every detail page. However, Capuccino is not hidden since it appeared on some pages:

Page 4 /5				
Region	State	City	Product Capuccino	Latte
West	CA	Los Angeles	\$306,468	\$809,647
		San Francisco	\$279,830	\$935,862
	WA	Seattle	\$309,197	\$924,896
Page 5 /5				
Region	State	City	Product Capuccino	Latte
TOTAL			\$2,381,590	\$10,943,622

Using Column Styling and Hiding Null ACROSS Columns

Column styling remains attached to the original column, regardless of whether the column remains in the same place on the report output because of hiding null columns. In particular:

- BORDERS and BACKCOLOR will readjust to fit the resulting panel or page layout after the columns are hidden.
- Styling specified for a designated column will remain attached to the designated column and be unaffected by the hidden columns. For example, if the third ACROSS column is defined with conditional styling, and the second ACROSS column is hidden, the formatting will remain on the column that was initially third, even though it becomes the second column on the output.

Using Column Styling and Hiding Null ACROSS Columns

In the following request against the GGSales data source, REGION is a BY field with a PAGE-BREAK and PRODUCT is the ACROSS field. The DEFINE command creates a field named SHOWDOLLARS that has missing values for the Capuccino column in the Midwest region, the Thermos column in the Northeast region, the Scone column in the Southeast region, and the entire West region. Column totals, row totals, and a subtotal for each region are generated.

Some of the columns are assigned background colors:

- Column C5 has BACKCOLOR=WHEAT. C5 is the fifth column counting display fields from left to right, but not counting BY fields or ROW-TOTAL fields. Column C5 corresponds to the **Croissant** column in the **Coffee** group.
- Column P5 has BACKCOLOR=THISTLE. P5 is the fifth column counting display fields, BY fields, and ROW-TOTAL fields, but not NOPRINT fields. Column P5 corresponds to the **Espresso** column in the **Coffee** group.
- Column N7 has BACKCOLOR=MEDIUM GOLDENROD. N7 is the seventh column counting display fields, BY fields, ROW-TOTAL fields, and NOPRINT fields. Column N7

corresponds to the **Biscotti** column in the **Food** group.

- Column B3 has BACKCOLOR=GOLDENROD. B3 is the third BY field, counting all BY fields, even if not printed. Column B3 corresponds to the **CITY** sort field.
- Column SHOWDOLLARS(6) has BACKCOLOR=SILVER. SHOWDOLLARS(6) is the sixth occurrence of the SHOWDOLLARS field and corresponds to the **Score** column in the **Food** group.

The request follows:

```

SET HIDE NULLACRS=OFF
DEFINE FILE GGSales
SHOWDOLLARS/I8M MISSING ON =
IF ((PRODUCT EQ 'Capuccino' AND REGION EQ 'Midwest') OR
(PRODUCT EQ 'Coffee Grinder' AND REGION EQ 'Northeast') OR
(PRODUCT EQ 'Scone' AND REGION EQ 'Southeast') OR
(REGION EQ 'West')) THEN MISSING ELSE DOLLARS;
END
TABLE FILE GGSales
SUM SHOWDOLLARS AS ''
BY REGION
BY ST
BY CITY
ACROSS CATEGORY
ACROSS PRODUCT
ON REGION SUBTOTAL AS '*TOTAL'
ON REGION PAGE-BREAK
HEADING
" Page <TABPAGENO "HEADING
" Capuccino Missing in Coffee Group "
WHEN REGION EQ 'Midwest';
HEADING
" Coffee Grinder Missing in Gifts Group "
WHEN REGION EQ 'Northeast';
HEADING
" Scone Missing in Food Group "
WHEN REGION EQ 'Southeast';
WHERE CATEGORY EQ 'Coffee' OR 'Food'
ON TABLE SET PAGE-NUM OFF
ON TABLE SET BYPANEL ON
ON TABLE ROW-TOTAL AS 'TOTAL'
ON TABLE COLUMN-TOTAL AS 'TOTAL'
ON TABLE SET HTMLCSS ON
ON TABLE HOLD FORMAT HTML
ON TABLE SET STYLE *
UNITS=IN,PAGESIZE='Letter',SQUEEZE=ON,ORIENTATION=PORTRAIT,$

```

```

TYPE=REPORT,HEADPANEL=ON,GRID=OFF, FONT='ARIAL',SIZE=6,$
TYPE=HEADING, style=bold, size=8,$
TYPE=DATA, COLUMN = C5, BACKCOLOR=WHEAT,$
TYPE=DATA, COLUMN = P5, BACKCOLOR=THISTLE,$
TYPE=DATA, COLUMN = N7, BACKCOLOR=MEDIUM GOLDENROD,$
TYPE=DATA, COLUMN = B3, BACKCOLOR=GOLDENROD,$
TYPE=DATA, COLUMN = SHOWDOLLARS(6), BACKCOLOR=silver,$
ENDSTYLE
END
    
```

Running the report with SET HIDE NULLACRS=OFF shows all columns. A page is generated for the West region and subtotals are calculated, even though all of the values are missing:

Page 1
Capuccino Missing in Coffee Group

Region	State	City	Category			Food			TOTAL
			Capuccino	Espresso	Latte	Biscotti	Croissant	Scone	
Midwest	IL	Chicago	-	\$420,439	\$978,340	\$378,412	\$549,366	\$595,069	\$2,921,626
	MO	St. Louis	-	\$419,143	\$966,981	\$368,077	\$613,871	\$481,953	\$2,850,025
	TX	Houston	-	\$455,365	\$938,245	\$345,238	\$587,887	\$418,398	\$2,745,133
*TOTAL Midwest			\$0	\$1,294,947	\$2,883,566	\$1,091,727	\$1,751,124	\$1,495,420	\$8,516,784

Coffee Grinder Missing in Gifts Group

Region	State	City	Category			Food			TOTAL
			Capuccino	Espresso	Latte	Biscotti	Croissant	Scone	
Northeast	CT	New Haven	\$158,995	\$279,373	\$926,052	\$589,355	\$551,489	\$283,874	\$2,789,138
	MA	Boston	\$174,344	\$248,356	\$917,737	\$570,391	\$497,234	\$332,486	\$2,740,546
	NY	New York	\$208,756	\$322,378	\$928,026	\$642,259	\$622,095	\$290,811	\$3,014,325
*TOTAL Northeast			\$542,095	\$850,107	\$2,771,815	\$1,802,005	\$1,670,818	\$907,171	\$8,544,011

Score Missing in Food Group									
			Category		Food				
			Coffee						
			Product						
Region	State	City	Capuccino	Espresso	Latte	Biscotti	Croissant	Scone	TOTAL
Southeast	FL	Orlando	\$317,027	\$256,539	\$389,887	\$511,597	\$602,076	-	\$2,577,126
	GA	Atlanta	\$352,161	\$317,389	\$907,365	\$555,231	\$661,806	-	\$2,793,952
	TN	Memphis	\$274,812	\$279,644	\$320,584	\$438,889	\$638,477	-	\$2,452,406
*TOTAL Southeast			\$944,000	\$853,572	\$2,617,836	\$1,505,717	\$1,902,359	\$0	\$7,823,484
			Category		Food				
			Coffee						
			Product						
Region	State	City	Capuccino	Espresso	Latte	Biscotti	Croissant	Scone	TOTAL
West	CA	Los Angeles	-	-	-	-	-	-	\$0
		San Francisco	-	-	-	-	-	-	\$0
	WA	Seattle	-	-	-	-	-	-	\$0
*TOTAL West			\$0	\$0	\$0	\$0	\$0	\$0	\$0
			Category		Food				
			Coffee						
			Product						
Region	State	City	Capuccino	Espresso	Latte	Biscotti	Croissant	Scone	TOTAL
TOTAL			\$1,486,095	\$2,998,626	\$8,273,217	\$4,399,449	\$5,324,301	\$2,402,591	\$24,884,279

Running the report with SET HIDE NULLACRS=ON, shows:

- On page 1, the Capuccino column is hidden and, therefore, the Espresso column is no longer P5 on the report, but it still has BACKCOLOR=THISTLE. Similarly, the Biscotti column has MEDIUM, GOLDENROD, the Croissant column has WHEAT, and the Scone column has SILVER.
- The subtotals for each region are calculated only for columns that display for that region.
- No page is generated for the West region since all of its values are missing.
- Every column is represented on the page with the grand totals.

The output is:

Page 1
Capuccino Missing in Coffee Group

Region	State	City	Category		Food			TOTAL
			Coffee		Food			
			Product	Espresso	Latte	Biscotti	Croissant	
Midwest	IL	Chicago	\$420,439	\$878,340	\$378,412	\$549,366	\$895,069	\$2,921,626
	MO	St. Louis	\$419,143	\$665,961	\$368,077	\$613,871	\$481,953	\$2,890,025
	TX	Houston	\$455,365	\$838,245	\$345,238	\$587,887	\$418,396	\$2,745,133
*TOTAL Midwest			\$1,294,947	\$2,883,566	\$1,091,727	\$1,751,124	\$1,495,420	\$8,516,784

Coffee Grinder Missing in Gifts Group

Region	State	City	Category		Food			TOTAL	
			Coffee		Food				
			Product	Capuccino	Espresso	Latte	Biscotti		Croissant
Northeast	CT	New Haven	\$158,995	\$279,373	\$205,052	\$589,355	\$551,489	\$283,874	\$2,789,138
	MA	Boston	\$174,344	\$248,356	\$917,737	\$570,391	\$497,234	\$332,486	\$2,740,548
	NY	New York	\$208,756	\$322,378	\$828,026	\$642,259	\$622,095	\$290,811	\$3,014,325
*TOTAL Northeast			\$542,095	\$850,107	\$2,771,815	\$1,802,005	\$1,670,818	\$907,171	\$8,544,011

Scone Missing in Food Group

Region	State	City	Category		Food			TOTAL
			Coffee		Food			
			Product	Capuccino	Espresso	Latte	Biscotti	
Southeast	FL	Orlando	\$317,027	\$256,539	\$889,887	\$511,597	\$602,076	\$2,577,126
	GA	Atlanta	\$352,161	\$317,389	\$907,365	\$555,231	\$661,806	\$2,793,952
	TN	Memphis	\$274,812	\$279,644	\$820,584	\$438,889	\$638,477	\$2,452,406
*TOTAL Southeast			\$944,000	\$853,572	\$2,617,836	\$1,505,717	\$1,902,359	\$7,823,484

Region	State	City	Category		Food			TOTAL	
			Coffee		Food				
			Product	Capuccino	Espresso	Latte	Biscotti		Croissant
TOTAL			\$1,496,095	\$2,968,626	\$8,273,217	\$4,399,449	\$5,324,301	\$2,402,591	\$24,884,279

Hiding Null ACROSS Columns in an FML Request

An FML request always has a FOR field that defines the order of specific rows. The FOR field cannot be used to trigger the hiding of null ACROSS columns. However, the request can also have a BY field with a PAGE-BREAK option and this can be used to hide null ACROSS columns.

Hiding Null ACROSS Columns in an FML Request

The following FML request against the GGSales data source has a BY field named REGION with the PAGE-BREAK option and an ACROSS field named QTR. The FOR field is PRODUCT. The DEFINE command creates the QTR field and contains missing values for Q4 in the Midwest region, Q2 in the Northeast region, and for all quarters in the Southeast region.

```

SET HIDENULLACRS=ON
DEFINE FILE GGSales
QTR/Q=DATE;
SHOWDOLLARS/D12CM MISSING ON =
    IF REGION EQ 'Midwest' AND QTR EQ 'Q4' THEN MISSING
    ELSE IF REGION EQ 'Northeast' AND QTR EQ 'Q2' THEN MISSING
    ELSE IF REGION EQ 'Southeast' THEN MISSING
    ELSE DOLLARS;
END
TABLE FILE GGSales
SUM SHOWDOLLARS
BY REGION
ACROSS QTR
FOR PRODUCT
'Biscotti' AS 'Biscotti' LABEL R1 OVER
'Capuccino' AS 'Capuccino' LABEL R2 OVER
'Latte' AS 'Latte' LABEL R3 OVER
'Mug' AS 'Mug' LABEL R4 OVER
'Coffee Pot' AS 'Coffee Pot' LABEL R5 OVER
RECAP R6/D12.2=R1+R2+R3+R4+R5;
AS ''
ON REGION PAGE-BREAK
ON TABLE SET PAGE-NUM OFF
ON TABLE NOTOTAL
ON TABLE HOLD FORMAT HTML
ON TABLE SET HTMLCSS ON

```

```

ON TABLE SET STYLE *
  UNITS=IN,
  SQUEEZE=ON,
  ORIENTATION=PORTRAIT,$
TYPE=REPORT,
  GRID=OFF,
  FONT='ARIAL',
  SIZE=9,$
TYPE=TITLE,
  STYLE=BOLD,$
TYPE=ACROSSTITLE,
  STYLE=BOLD,$
ENDSTYLE
END

```

Running the request with SET HIDE NULLACRS=OFF generates all columns and a page for all regions, including the Southeast regions where all values are missing:

		QTR			
		Q1	Q2	Q3	Q4
Region					
Midwest	Biscotti	\$205,440	\$252,072	\$275,976	.
	Capuccino
	Latte	\$630,883	\$704,089	\$776,434	.
	Mug	\$261,825	\$264,003	\$261,527	.
	Coffee Pot	\$128,026	\$169,533	\$164,565	.
		1,226,174.00	1,389,697.00	1,478,502.00	.
		QTR			
		Q1	Q2	Q3	Q4
Region					
Northeast	Biscotti	\$393,362	.	\$512,375	\$453,794
	Capuccino	\$62,070	.	\$175,864	\$185,712
	Latte	\$791,332	.	\$652,872	\$628,026
	Mug	\$265,133	.	\$307,917	\$308,783
	Coffee Pot	\$130,517	.	\$145,670	\$163,594
		1,642,414.00	.	1,794,698.00	1,739,909.00

		QTR			
Region		Q1	Q2	Q3	Q4
Southeast	Biscotti
	Capuccino
	Latte
	Mug
	Coffee Pot
	
		QTR			
Region		Q1	Q2	Q3	Q4
West	Biscotti	\$229,781	\$224,070	\$230,649	\$179,368
	Capuccino	\$205,057	\$194,149	\$237,778	\$258,511
	Latte	\$727,734	\$664,618	\$619,832	\$658,221
	Mug	\$296,839	\$281,809	\$313,692	\$296,324
	Coffee Pot	\$132,354	\$159,799	\$153,072	\$168,399
		1,591,765.00	1,524,445.00	1,555,023.00	1,560,823.00

Running the request with SET HIDENULLACRS=ON hides column Q4 for the Midwest region, Q2 for the Northeast region, and the entire page for the Southeast region:

		QTR		
		Q1	Q2	Q3
Region				
Midwest	Biscotti	\$205,440	\$252,072	\$275,976
	Capuccino	.	.	.
	Latte	\$630,883	\$704,089	\$776,434
	Mug	\$261,825	\$264,003	\$261,527
	Coffee Pot	\$128,026	\$169,533	\$164,565
		1,226,174.00	1,389,697.00	1,478,502.00

		QTR		
		Q1	Q3	Q4
Region				
Northeast	Biscotti	\$393,362	\$512,375	\$453,794
	Capuccino	\$62,070	\$175,864	\$185,712
	Latte	\$791,332	\$652,872	\$628,026
	Mug	\$265,133	\$307,917	\$308,783
	Coffee Pot	\$130,517	\$145,670	\$163,594
		1,642,414.00	1,794,698.00	1,739,909.00

		QTR			
		Q1	Q2	Q3	Q4
Region					
West	Biscotti	\$229,781	\$224,070	\$230,649	\$179,368
	Capuccino	\$205,057	\$194,149	\$237,778	\$258,511
	Latte	\$727,734	\$664,618	\$619,832	\$658,221
	Mug	\$296,839	\$281,809	\$313,692	\$296,324
	Coffee Pot	\$132,354	\$159,799	\$153,072	\$168,399
		1,591,765.00	1,524,445.00	1,555,023.00	1,560,823.00

Controlling Display of Sort Field Values

By default, a sort field value displays only on the first row or column of the set of detail rows or columns generated for that sort field value. You can control this behavior using the BYDISPLAY parameter. BYDISPLAY is supported for all output formats and can control the display of ACROSS values as well as BY values.

This feature enables you to avoid specifying the sort field twice, once as a display field and once for sorting (with the NOPRINT option). For example:

```
PRINT FIRST_NAME LAST_NAME  
BY FIRST_NAME NOPRINT
```

Control Display of Sort Field Values

```
SET BYDISPLAY = {OFF|ON|BY|ACROSS|ALL}
```

```
ON TABLE SET BYDISPLAY {OFF|ON|BY|ACROSS|ALL}
```

where:

OFF

Displays a sort field value only on the first line or column of the report output for the sort group and on the first line or column of a page. OFF is the default value.

ON or BY

Displays the relevant BY field value on every line of report output produced. BY is a synonym for ON.

ACROSS

Displays the relevant ACROSS field value on every column of report output produced.

ALL

Displays the relevant BY field value on every line of report output and the relevant ACROSS field value on every column of report output.

Controlling Display of Sort Field Values on Report Output

The following request generates a report on which sort field values only display when they change (BYDISPLAY OFF).

```

-SET &BYDISP = OFF;
SET BYDISPLAY = &BYDISP
TABLE FILE WFLITE
HEADING CENTER
" BYDISPLAY = &BYDISP"
" "
SUM QUANTITY_SOLD DAYSDELAYED
BY PRODUCT_CATEGORY
BY PRODUCT_SUBCATEG
ACROSS BUSINESS_REGION
ON TABLE SET PAGE NOLEAD
ON TABLE SET STYLE *
GRID=OFF,$
ENDSTYLE
END

```

The output is shown in the following image.

BYDISPLAY = OFF										
		Customer,Business,Region								
Product Category	Product Subcategory	EMEA		North America		Oceania		South America		
		Quantity Sold	Days Delayed	Quantity Sold	Days Delayed	Quantity Sold	Days Delayed	Quantity Sold	Days Delayed	
Accessories	Charger	187	55	220	84	.	.	26	25	
	Headphones	403	137	470	180	2	0	56	18	
	Universal Remote Controls	287	102	325	132	7	7	51	23	
Camcorder	Handheld	466	200	527	209	4	1	94	20	
	Professional	23	4	35	17	
	Standard	344	157	404	130	1	0	58	37	
Computers	Smartphone	384	162	411	151	5	2	65	27	
Media Player	Blu Ray	1,206	495	1,395	518	15	11	203	78	
	DVD Players	32	14	48	17	.	.	13	0	
	Streaming	88	30	124	53	3	0	13	2	
Stereo Systems	Home Theater Systems	741	239	847	349	4	5	138	59	
	Receivers	266	90	282	109	.	.	68	21	
	Speaker Kits	451	172	476	199	.	.	95	33	
	iPod Docking Station	529	186	673	272	7	0	102	62	
Televisions	Flat Panel TV	159	67	166	62	1	0	36	15	
Video Production	Video Editing	381	139	445	150	3	1	58	27	

Changing BYDISPLAY to ON or BY displays BY field values on every row, as shown in the following image.

BYDISPLAY = BY									
Product Category	Product Subcategory	Customer,Business,Region							
		EMEA		North America		Oceania		South America	
		Quantity Sold	Days Delayed	Quantity Sold	Days Delayed	Quantity Sold	Days Delayed	Quantity Sold	Days Delayed
Accessories	Charger	187	55	220	84	.	.	26	25
Accessories	Headphones	403	137	470	180	2	0	56	18
Accessories	Universal Remote Controls	287	102	325	132	7	7	51	23
Camcorder	Handheld	466	200	527	209	4	1	94	20
Camcorder	Professional	23	4	35	17
Camcorder	Standard	344	157	404	130	1	0	58	37
Computers	Smartphone	384	162	411	151	5	2	65	27
Media Player	Blu Ray	1,206	495	1,395	518	15	11	203	78
Media Player	DVD Players	32	14	48	17	.	.	13	0
Media Player	Streaming	88	30	124	53	3	0	13	2
Stereo Systems	Home Theater Systems	741	239	847	349	4	5	138	59
Stereo Systems	Receivers	266	90	282	109	.	.	68	21
Stereo Systems	Speaker Kits	451	172	476	199	.	.	95	33
Stereo Systems	iPod Docking Station	529	186	673	272	7	0	102	62
Televisions	Flat Panel TV	159	67	166	62	1	0	36	15
Video Production	Video Editing	381	139	445	150	3	1	58	27

Changing BYDISPLAY to ACROSS displays ACROSS field values over every column, as shown in the following image.

BYDISPLAY = ACROSS									
Product Category	Product Subcategory	Customer,Business,Region							
		EMEA	EMEA	North America	North America	Oceania	Oceania	South America	South America
		Quantity Sold	Days Delayed	Quantity Sold	Days Delayed	Quantity Sold	Days Delayed	Quantity Sold	Days Delayed
Accessories	Charger	187	55	220	84	.	.	26	25
	Headphones	403	137	470	180	2	0	56	18
	Universal Remote Controls	287	102	325	132	7	7	51	23
Camcorder	Handheld	466	200	527	209	4	1	94	20
	Professional	23	4	35	17
	Standard	344	157	404	130	1	0	58	37
Computers	Smartphone	384	162	411	151	5	2	65	27
Media Player	Blu Ray	1,206	495	1,395	518	15	11	203	78
	DVD Players	32	14	48	17	.	.	13	0
	Streaming	88	30	124	53	3	0	13	2
Stereo Systems	Home Theater Systems	741	239	847	349	4	5	138	59
	Receivers	266	90	282	109	.	.	68	21
	Speaker Kits	451	172	476	199	.	.	95	33
	iPod Docking Station	529	186	673	272	7	0	102	62
Televisions	Flat Panel TV	159	67	166	62	1	0	36	15
Video Production	Video Editing	381	139	445	150	3	1	58	27

Changing BYDISPLAY to ALL displays BY field values on every row and ACROSS field values over every column, as shown in the following image.

BYDISPLAY = ALL										
Product Category	Product Subcategory	Customer,Business,Region								
		EMEA Quantity Sold	EMEA Days Delayed	North America Quantity Sold	North America Days Delayed	Oceania Quantity Sold	Oceania Days Delayed	South America Quantity Sold	South America Days Delayed	
Accessories	Charger	187	55	220	84	.	.	26	25	
Accessories	Headphones	403	137	470	180	2	0	56	18	
Accessories	Universal Remote Controls	287	102	325	132	7	7	51	23	
Camcorder	Handheld	466	200	527	209	4	1	94	20	
Camcorder	Professional	23	4	35	17	
Camcorder	Standard	344	157	404	130	1	0	58	37	
Computers	Smartphone	384	162	411	151	5	2	65	27	
Media Player	Blu Ray	1,206	495	1,395	518	15	11	203	78	
Media Player	DVD Players	32	14	48	17	.	.	13	0	
Media Player	Streaming	88	30	124	53	3	0	13	2	
Stereo Systems	Home Theater Systems	741	239	847	349	4	5	138	59	
Stereo Systems	Receivers	266	90	282	109	.	.	68	21	
Stereo Systems	Speaker Kits	451	172	476	199	.	.	95	33	
Stereo Systems	iPod Docking Station	529	186	673	272	7	0	102	62	
Televisions	Flat Panel TV	159	67	166	62	1	0	36	15	
Video Production	Video Editing	381	139	445	150	3	1	58	27	

Reformatting Sort Fields

When displaying a vertical (BY) sort column or horizontal (ACROSS) sort row on report output, you can reformat the sort field values by specifying the new format in the sort phrase. The reformatting affects only the sort field value as displayed on the sort row or column. That is, if the field used as a sort field is referenced in a heading, subheading, footing, subfooting, or summary line, it displays with its original format.

Reformat a Sort Field

```
{BY [TOTAL]|ACROSS [TOTAL]} sortfield/fmt ...
```

where:

sortfield

Is the sort field.

fmt

Is the new display format.

Usage Notes for Reformatting Sort Fields

- Reformatting is not supported in an ON phrase.
- Reformatting is only applied to the row or column generated by the sort phrase, not to subheading, subfooting, or summary rows that reference the sort field.
- Field-based reformatting (the format is stored in a field) is not supported for sort fields. For information on field-based reformatting, see [Applying Dynamically Formatted Virtual Fields to Report Columns](#).
- BY field reformatting is propagated to HOLD files. ACROSS field reformatting *is not* propagated to HOLD files.
- The following features issue a warning, ignore the reformatting, and proceed with the request:
 - IN-GROUPS/RANGES-OF
 - ROWS
 - COLUMNS
 - FOR field/reformat
- All decisions are made based on an original field, therefore any option on a reformatted sort field should be placed on an original sort field break point. As a consequence, whenever the sort field value should appear (for example, in SUBTOTALS) an original field value displays.

Reformatting Sort Fields

The following request against the GGSales data source includes the following reformatted sort fields:

- BY CATEGORY, with CATEGORY reformatted as A3.
- BY PRODUCT, with PRODUCT reformatted as A4.
- ACROSS REGION, with region reformatted as A6.

```
TABLE FILE GGSales  
SUM UNIT
```

```

BY CATEGORY/A3
BY PRODUCT/A4
ACROSS REGION/A6
ON CATEGORY SUBTOTAL
ON CATEGORY SUBHEAD
"CATEGORY IS <CATEGORY "
" "
ON TABLE SET PAGE NOPAGE
END

```

On the output, the reformatting displays on the BY and ACROSS rows but is not propagated to the subheading and subtotal rows:

CATEGORY	PRODUCT	REGION			
		Midwes	Northe	Southe	West

CATEGORY IS Coffee					
Cof	Capu	.	44785	73264	72831
	Espr	101154	68127	68030	71675
	Latt	231623	226243	211063	213920
*TOTAL CATEGORY Coffee		332777	339155	352357	358426
CATEGORY IS Food					
Foo	Bisc	90413	149793	119594	70569
	Croi	139881	137394	156456	197022
	Scon	116127	70732	73779	72776
*TOTAL CATEGORY Food		346421	357919	349829	340367
CATEGORY IS Gifts					
Gif	Coff	54002	40977	50556	48081
	Coff	47156	46185	49922	47432
	Mug	86718	91497	88474	93881
	Ther	46587	48870	48976	45648
*TOTAL CATEGORY Gifts		234463	227529	237928	235042
TOTAL		913661	924603	940114	933835

Manipulating Display Field Values in a Sort Group

You can use the WITHIN phrase to manipulate a display field value as they are aggregated within a sort group. This technique can be used with a prefix operator to perform calculations on a specific aggregate field rather than a report column. In contrast, the SUM and COUNT commands aggregate an entire column.

The WITHIN phrase requires a BY phrase and/or an ACROSS phrase. A maximum of two WITHIN phrases can be used per display field. If one WITHIN phrase is used, it must act on a BY phrase. If two WITHIN phrases are used, the first must act on a BY phrase and the second on an ACROSS phrase.

You can also use WITHIN TABLE, which allows you to return the original value within a request command. The WITHIN TABLE command can also be used when an ACROSS phrase is needed without a BY phrase. Otherwise, a single WITHIN phrase requires a BY phrase.

Use WITHIN to Manipulate Display Fields

```
{SUM|COUNT} display_field WITHIN by_sort_field [WITHIN across_sort_field]
    BY by_sort_field [ACROSS across_sort_field]
```

where:

display_field

Is the object of a SUM or COUNT display command.

by_sort_field

Is the object of a BY phrase.

across_sort_field

Is the object of an ACROSS phrase.

Summing Values Within Sort Groups

The following report shows the units sold and the percent of units sold for each product within store and within the table:

```
TABLE FILE SALES
SUM UNIT_SOLD AS 'UNITS'
AND PCT.UNIT_SOLD AS 'PCT,SOLD,WITHIN,TABLE'
AND PCT.UNIT_SOLD WITHIN STORE_CODE AS 'PCT,SOLD,WITHIN,STORE'
BY STORE_CODE SKIP-LINE BY PROD_CODE
END
```

The output is:

STORE_CODE	PROD_CODE	UNITS	PCT SOLD WITHIN TABLE	PCT SOLD WITHIN STORE
-----	-----	-----	-----	-----
K1	B10	13	2	30
	B12	29	4	69
14B	B10	60	9	15
	B12	40	6	10
	B17	29	4	7
	C13	25	3	6
	C7	45	6	11
	D12	27	4	7
	E2	80	12	21
E3	70	10	18	
14Z	B10	30	4	18
	B17	20	3	12
	B20	15	2	9
	C17	12	1	7
	D12	20	3	12
	E1	30	4	18
	E3	35	5	21
77F	B20	25	3	38
	C7	40	6	61

STORE_CODE	PROD_CODE	UNITS	PCT SOLD WITHIN TABLE	PCT SOLD WITHIN STORE
14B	B10	60	9	15
	B12	40	6	10
	B17	29	4	7
	C13	25	3	6
	C7	45	6	11
	D12	27	4	7
	E2	80	12	21
14Z	E3	70	10	18
	B10	30	4	18
	B17	20	3	12
	B20	15	2	9
	C17	12	1	7
	D12	20	3	12
	E1	30	4	18
77F	E3	35	5	21
	B20	25	3	38
K1	C7	40	6	61
	B10	13	2	30
	B12	29	4	69

Creating a Matrix Report

You can create a matrix report by sorting both rows and columns. When you include both BY and ACROSS phrases in a report request, information is sorted vertically and horizontally, turning the report into a matrix of information that you read like a grid. A matrix report can have multiple BY and ACROSS sort fields.

Creating a Simple Matrix

The following request displays total salary outlay across departments and by job codes, creating a matrix report.

```
TABLE FILE EMPLOYEE
SUM CURR_SAL
ACROSS DEPARTMENT
BY CURR_JOBCODE
END
```

The output is:

CURR_JOBCODE	DEPARTMENT	
	MIS	PRODUCTION
A01	.	\$9,500.00
A07	\$9,000.00	\$11,000.00
A15	.	\$26,862.00
A17	\$27,062.00	\$29,700.00
B02	\$18,480.00	\$16,100.00
B03	\$18,480.00	.
B04	\$21,780.00	\$21,120.00
B14	\$13,200.00	.

Creating a Matrix With Several Sort Fields

The following request uses several BY and ACROSS sort fields to create a matrix report.

```
TABLE FILE EMPLOYEE
SUM CURR_SAL
ACROSS DEPARTMENT ACROSS LAST_NAME
BY CURR_JOBCODE BY ED_HRS
WHERE DEPARTMENT EQ 'MIS'
WHERE CURR_SAL GT 21500
END
```

The output is:

CURR_JOBCODE	ED_HRS	DEPARTMENT	
		MIS	CROSS
A17	45.00	.	\$27,062.00
B04	75.00	\$21,780.00	.

Controlling Collation Sequence

Collation is defined as a set of rules that apply to the ordering and matching of all language elements that involve comparison of two values. A wide variety of elements are affected by this feature. Among these features are sorting, aggregation, WHERE conditions, and StyleSheets. By default, items are sorted based on their binary values. The COLLATION settings SRV_CI and SRV_CS, case-insensitive and case-sensitive collation, implement collation based on the LANGUAGE setting. Case-insensitive collation means that all WHERE clauses and sorts ignore the case of the elements being compared. COLLATION is a session level setting (it is not supported in an ON TABLE phrase and should be set in the profile).

The collation setting applies only to alphanumeric values.

Establish Binary or Case-Insensitive Collation Sequence

Add the following command to the profile:

```
SET COLLATION = {BINARY|SRV_CI|SRV_CS|CODEPAGE}
```

where:

BINARY

Bases the collation sequence on binary values.

SRV_CI

Bases collation sequence on the LANGUAGE setting, and is case-insensitive.

SRV_CS

Bases collation sequence on the LANGUAGE setting, and is case-sensitive.

CODEPAGE

Bases collation sequence on the code page in effect, and is case-sensitive. CODEPAGE is the default value.

In most cases, CODEPAGE is the same as BINARY. The only differences are for Danish, Finnish, German, Norwegian, and Swedish in an EBCDIC environment.

Usage Notes for SET COLLATION

- SUFFIX=FIX or SUFFIX=FOCUS/XFOCUS HOLD files created in one mode may not be usable as targets for a JOIN in another mode if the join field is on alphanumeric data with mixed-cases.
- FIXRETRIEVE is supported only for binary data, so setting COLLATION to anything other than BINARY will turn FIXRETRIEVE OFF, which may affect join performance.

Rules for Sorting and Aggregation

- Records with the same characters in the same order, but with variations in case, are considered to be identical. If multiple input records have these variations, the value used is from the first such record.
- In a detail level report, the sort value is the same for each output record. That value will be the one for the input record that had the lowest value (collated first).
- When the MIN (or the MAX) value for two or more alphanumeric display fields having a given instance of the sort field values is the same by case-insensitive collation, but the two values vary by case in some positions, the one retained is the last one in the input file (highest input record number) when SUMPREF=LST and the first (lowest record number) when SUMPREF=FST.

Using Binary and Case-Insensitive Collation Sequence for Sorting

The following request creates a FOCUS data source named COLLATE that has some records with product names that differ only by the case of one letter:

```
CREATE FILE COLLATE
-RUN
MODIFY FILE COLLATE
FIXFORM PROD_NUM/C4  PRODNAME/C30  QTY_IN_STOCK/C7  PRICE/C12  COST/C12
CHECK OFF
DATA
10042 Hd VCR LCD Menu           43068           179.00           129.00
10052 HD VCR LCD Menu           43068           179.00           129.00
1006Combo Player - 4 HD VCR + DVD 13527           399.00           289.00
1007Combo Player - 4 Hd VCR + DVD 13527           399.00           289.00
```

1008DVD Upgrade Unit for Cent. VCR	199	199.00	139.00
1010750SL Digital Camcorder 300 X	10758	999.00	750.00
1012650DL Digital Camcorder 150 X	2972	899.00	710.00
1014340SX Digital Camera 65K P	990	249.00	199.00
1015340SX digital Camera 65K P	990	249.00	199.00
1016330DX Digital Camera 1024K P	12707	279.00	199.00
1018250 8MM Camcorder 40 X	60073	399.00	320.00
1019250 8mm Camcorder 40 X	60073	399.00	320.00
1020150 8MM Camcorder 20 X	5961	319.00	240.00
1022120 VHS-C Camcorder 40 X	2300	399.00	259.00
1024110 VHS-C Camcorder 20 X	4000	349.00	249.00
1026AR2 35mm Camera 8 X	12444	129.00	95.00
1029AR2 35MM Camera 8 X	11499	109.00	79.00
1028AR3 35MM Camera 10 X	11499	109.00	79.00
1030QX Portable CD Player	22000	169.00	99.00
1032R5 Micro Digital Tape Recorder	1990	89.00	69.00
1034ZT Digital PDA - Commercial	21000	499.00	349.00
1036ZC Digital PDA - Standard	33000	299.00	249.00
END			

The following request prints the values of PRODNAME in the order in which they are encountered in the input stream:

```
TABLE FILE COLLATE
PRINT PROD_NUM PRODNAME
END
```

On the output, the rows with product numbers 1004 and 1005 differ only in the case of the letter **d** in **HD**. The record with the lowercase **d** is before the record with the uppercase **D**. The rows with record numbers 1006 and 1007 also differ only in the case of the letter **d** in **HD**. In this case, the record with the uppercase **D** is before the record with the lowercase **d**:

Product Number:	Product Name:
-----	-----
1004	2 Hd VCR LCD Menu
1005	2 HD VCR LCD Menu
1006	Combo Player - 4 HD VCR + DVD
1007	Combo Player - 4 Hd VCR + DVD
1008	DVD Upgrade Unit for Cent. VCR
1010	750SL Digital Camcorder 300 X
1012	650DL Digital Camcorder 150 X
1014	340SX Digital Camera 65K P
1015	340SX digital Camera 65K P

```

1016      330DX Digital Camera 1024K P
1018      250 8MM Camcorder 40 X
1019      250 8mm Camcorder 40 X
1020      150 8MM Camcorder 20 X
1022      120 VHS-C Camcorder 40 X
1024      110 VHS-C Camcorder 20 X
1026      AR2 35mm Camera 8 X
1029      AR2 35MM Camera 8 X
1028      AR3 35MM Camera 10 X
1030      QX Portable CD Player
1032      R5 Micro Digital Tape Recorder
1034      ZT Digital PDA - Commercial
1036      ZC Digital PDA - Standard

```

The next request sorts the output in BINARY order. The setting COLLATION = BINARY is in effect:

```

TABLE FILE COLLATE
PRINT PROD_NUM
BY PRODNAME
END

```

In an EBCDIC environment, the records with the lowercase letters sort in front of the records with the uppercase letters, so the row with product number 1007 sorts in front of the row with product number 1006:

Product Name: -----	Product Number: -----
AR2 35mm Camera 8 X	1026
AR2 35MM Camera 8 X	1029
AR3 35MM Camera 10 X	1028
Combo Player - 4 Hd VCR + DVD	1007
Combo Player - 4 HD VCR + DVD	1006
DVD Upgrade Unit for Cent. VCR	1008
QX Portable CD Player	1030
R5 Micro Digital Tape Recorder	1032
ZC Digital PDA - Standard	1036
ZT Digital PDA - Commercial	1034
110 VHS-C Camcorder 20 X	1024
120 VHS-C Camcorder 40 X	1022
150 8MM Camcorder 20 X	1020
2 Hd VCR LCD Menu	1004
2 HD VCR LCD Menu	1005

250 8mm Camcorder 40 X	1019
250 8MM Camcorder 40 X	1018
330DX Digital Camera 1024K P	1016
340SX digital Camera 65K P	1015
340SX Digital Camera 65K P	1014
650DL Digital Camcorder 150 X	1012
750SL Digital Camcorder 300 X	1010

In an ASCII environment, the records with the uppercase letters sort in front of the records with the lowercase letters, so the row with product number 1005 sorts in front of the row with product number 1004:

Product Name:	Product Number:
-----	-----
110 VHS-C Camcorder 20 X	1024
120 VHS-C Camcorder 40 X	1022
150 8MM Camcorder 20 X	1020
2 HD VCR LCD Menu	1005
2 Hd VCR LCD Menu	1004
250 8MM Camcorder 40 X	1018
250 8mm Camcorder 40 X	1019
330DX Digital Camera 1024K P	1016
340SX Digital Camera 65K P	1014
340SX digital Camera 65K P	1015
650DL Digital Camcorder 150 X	1012
750SL Digital Camcorder 300 X	1010
AR2 35MM Camera 8 X	1029
AR2 35mm Camera 8 X	1026
AR3 35MM Camera 10 X	1028
Combo Player - 4 HD VCR + DVD	1006
Combo Player - 4 Hd VCR + DVD	1007
DVD Upgrade Unit for Cent. VCR	1008
QX Portable CD Player	1030
R5 Micro Digital Tape Recorder	1032
ZC Digital PDA - Standard	1036
ZT Digital PDA - Commercial	1034

With COLLATION set to SRV_CI and a sort on the PRODDNAME field, the uppercase and lowercase letters have the same value, so the row displays only once for multiple record numbers. For example, the rows with product numbers 1004 and 1005 display with the same PRODDNAME value and the sort field value for the display is the first one in the input stream.

The following shows the output in an EBCDIC environment:

Product Name:	Product Number:
-----	-----
AR2 35mm Camera 8 X	1026
	1029
AR3 35MM Camera 10 X	1028
Combo Player - 4 HD VCR + DVD	1006
	1007
DVD Upgrade Unit for Cent. VCR	1008
QX Portable CD Player	1030
R5 Micro Digital Tape Recorder	1032
ZC Digital PDA - Standard	1036
ZT Digital PDA - Commercial	1034
110 VHS-C Camcorder 20 X	1024
120 VHS-C Camcorder 40 X	1022
150 8MM Camcorder 20 X	1020
2 Hd VCR LCD Menu	1004
	1005
250 8MM Camcorder 40 X	1018
250 8MM Camcorder 40 X	1019
330DX Digital Camera 1024K P	1016
340SX Digital Camera 65K P	1014
	1015
650DL Digital Camcorder 150 X	1012
750SL Digital Camcorder 300 X	1010

The following shows the output in an ASCII environment:

Product Name:	Product Number:
-----	-----
110 VHS-C Camcorder 20 X	1024
120 VHS-C Camcorder 40 X	1022
150 8MM Camcorder 20 X	1020
2 Hd VCR LCD Menu	1004
	1005
250 8MM Camcorder 40 X	1018
	1019
330DX Digital Camera 1024K P	1016
340SX Digital Camera 65K P	1014
	1015
650DL Digital Camcorder 150 X	1012
750SL Digital Camcorder 300 X	1010
AR2 35mm Camera 8 X	1026
	1029
AR3 35MM Camera 10 X	1028

Combo Player - 4 HD VCR + DVD	1006
	1007
DVD Upgrade Unit for Cent. VCR	1008
QX Portable CD Player	1030
R5 Micro Digital Tape Recorder	1032
ZC Digital PDA - Standard	1036
ZT Digital PDA - Commercial	1034

Using Binary and Case-Insensitive Collation Sequence for Selection

The following request against the COLLATE data source selects records in which the PRODNAME contains the characters 'HD':

```
TABLE FILE COLLATE
PRINT PROD_NUM PRODNAME
WHERE PRODNAME CONTAINS 'HD'
END
```

With COLLATION set to BINARY, only the records with an exact match (uppercase HD) are selected. The output is:

Product Number:	Product Name:
-----	-----
1005	2 HD VCR LCD Menu
1006	Combo Player - 4 HD VCR + DVD

Running the same request but changing the COLLATION parameter to SRV_CI selects all records with any combination of uppercase and lowercase values for H and D. The rows are displayed in the order in which they appeared in the data source:

Product Number:	Product Name:
-----	-----
1004	2 Hd VCR LCD Menu
1005	2 HD VCR LCD Menu
1006	Combo Player - 4 HD VCR + DVD
1007	Combo Player - 4 Hd VCR + DVD

Specifying the Sort Order

Sort field values are automatically displayed in ascending order, beginning with the lowest value and continuing to the highest. The default sorting sequence varies for operating systems. On z/OS it is a-z, A-Z, 0-9 for alphanumeric fields; 0-9 for numeric fields. On UNIX and Windows it is 0-9, A-Z, a-z for alphanumeric fields; 0-9 for numeric fields.

You have the option of overriding this default and displaying values in descending order, ranging from the highest value to the lowest value, by including HIGHEST in the sort phrase.

Specify the Sort Order

```
{BY|ACROSS} {LOWEST|HIGHEST} sortfield
```

where:

LOWEST

Sorts in ascending order, beginning with the lowest value and continuing to the highest value (a-z, A-Z, 0-9 for alphanumeric fields; 0-9 for numeric fields). This option is the default.

HIGHEST

Sorts in descending order, beginning with the highest value and continuing to the lowest value. You can also use TOP as a synonym for HIGHEST.

sortfield

Is the name of the sort field.

Sorting in Ascending Order

The following report request does not specify a particular sorting order, and so, by default, it lists salaries ranging from the lowest to the highest.

```
TABLE FILE EMPLOYEE
PRINT LAST_NAME
BY CURR_SAL
END
```

You can specify this same ascending order explicitly by including **LOWEST** in the sort phrase.

```
TABLE FILE EMPLOYEE
PRINT LAST_NAME
BY LOWEST CURR_SAL
END
```

The output is:

```
      CURR_SAL  LAST_NAME
      -----  -
      $9,000.00 GREENSPAN
      $9,500.00 SMITH
      $11,000.00 STEVENS
      $13,200.00 SMITH
      $16,100.00 MCKNIGHT
      $18,480.00 JONES
                   MCCOY
      $21,120.00 ROMANS
      $21,780.00 BLACKWOOD
      $26,862.00 IRVING
      $27,062.00 CROSS
      $29,700.00 BANNING
```

<u>CURR SAL</u>	<u>LAST NAME</u>
\$9,000.00	GREENSPAN
\$9,500.00	SMITH
\$11,000.00	STEVENS
\$13,200.00	SMITH
\$16,100.00	MCKNIGHT
\$18,480.00	JONES
	MCCOY
\$21,120.00	ROMANS
\$21,780.00	BLACKWOOD
\$26,862.00	IRVING
\$27,062.00	CROSS
\$29,700.00	BANNING

Sorting in Descending Order

The following request lists salaries ranging from the highest to lowest.

```
TABLE FILE EMPLOYEE
PRINT LAST_NAME
BY HIGHEST CURR_SAL
END
```

The output is:

```
      CURR_SAL  LAST_NAME
-----  -
$29,700.00  BANNING
$27,062.00  CROSS
$26,862.00  IRVING
$21,780.00  BLACKWOOD
$21,120.00  ROMANS
$18,480.00  JONES
           MCCOY
$16,100.00  MCKNIGHT
$13,200.00  SMITH
$11,000.00  STEVENS
   $9,500.00  SMITH
   $9,000.00  GREENSPAN
```

<u>CURR_SAL</u>	<u>LAST_NAME</u>
\$29,700.00	BANNING
\$27,062.00	CROSS
\$26,862.00	IRVING
\$21,780.00	BLACKWOOD
\$21,120.00	ROMANS
\$18,480.00	JONES
	MCCOY
\$16,100.00	MCKNIGHT
\$13,200.00	SMITH
\$11,000.00	STEVENS
\$9,500.00	SMITH
\$9,000.00	GREENSPAN

Specifying Your Own Sort Order

Sort field values are automatically displayed in ascending order, beginning with the lowest value and continuing to the highest.

You can override the default order and display values in your own user-defined sorting sequence. To do this, you need to decide the following:

1. Which sort field values you want to allow. You can specify every sort field value, or a subset of values. When you issue your report request, only records containing those values are included in the report.
2. The order in which you want the values to appear. You can specify any order. For example, you could specify that an A1 sort field containing a single-letter code be sorted in the order A, Z, B, C, Y, and so on.

There are two ways to specify your own sorting order, depending on whether you are sorting rows with BY, or sorting columns with ACROSS:

- The BY ROWS OVER phrase, for defining your own row sort sequence.
- The ACROSS COLUMNS AND phrase, for defining your own column sort sequence.

Define Your Own Sort Order

```
BY sortfield AS 'coltitle' ROWS value1 [AS 'text1']
OVER value2 [AS 'text2']
[... OVER valuen [ AS 'textn']]
END
```

where:

sortfield

Is the last BY field in the report.

coltitle

Is the column title for the BY field on the report output.

value1

Is the sort field value that is first in the sorting sequence.

AS 'text1'

Enables you to assign alternate text for the first row, which replaces the field value in the output. Enclose the text in single quotation marks.

value2

Is the sort field value that is second in the sorting sequence.

AS 'text2'

Enables you to assign alternate text for the second row, which replaces the field value in the output. Enclose the text in single quotation marks.

valuen

Is the sort field value that is last in the sorting sequence.

AS 'textn'

Enables you to assign alternate text for the last row, which replaces the field value in the output. Enclose the text in single quotation marks.

An alternative syntax is

```
FOR sortfield  
value1 OVER value2 [... OVER valuen]
```

which uses the row-based reporting phrase FOR, described in [Creating Financial Reports With Financial Modeling Language \(FML\)](#).

Usage Notes for Defining Your Sort Order

- Any sort field value that you do not specify in the BY ROWS OVER phrase is not included in the sorting sequence, and does not appear in the report.
- Sort field values that contain embedded blank spaces should be enclosed in single quotation marks (').
- Any sort field value that you do specify in the BY ROWS OVER phrase is included in the report, whether or not there is data.
- If missing data is included in the report, it must be inserted at the lowest sort level.

- The name of the sort field is not included in the report.
- Each report request can contain only one BY ROWS OVER phrase. BY ROWS OVER is not supported with the FOR phrase. For information about the FOR phrase, see [Creating Financial Reports With Financial Modeling Language \(FML\)](#).

Defining Your Row Sort Order

The following illustrates how to sort employees by the banks at which their paychecks are automatically deposited, and how to define your own label in the sorting sequence for the bank field.

```
TABLE FILE EMPLOYEE
PRINT LAST_NAME
BY BANK_NAME ROWS 'BEST BANK' OVER STATE
   OVER ASSOCIATED OVER 'BANK ASSOCIATION'
END
```

The output is:

	LAST_NAME

BEST BANK	BANNING
STATE	JONES
ASSOCIATED	IRVING
ASSOCIATED	BLACKWOOD
ASSOCIATED	MCKNIGHT
BANK ASSOCIATION	CROSS

	<u>LAST_NAME</u>
BEST BANK	BANNING
STATE	JONES
ASSOCIATED	IRVING
ASSOCIATED	BLACKWOOD
ASSOCIATED	MCKNIGHT
BANK ASSOCIATION	CROSS

Define Column Sort Sequence

```
ACROSS sortfield COLUMNS value1 AND value2 [... AND valuen]
```

where:

sortfield

Is the name of the sort field.

value1

Is the sort field value that is first in the sorting sequence.

value2

Is the sort field value that is second in the sorting sequence.

valuen

Is the sort field value that is last in the sorting sequence.

ACROSS COLUMNS AND phrase

- Any sort field value that you do not specify in the ACROSS COLUMNS AND phrase is not included in the label within the sorting sequence, and does not appear in the report.
- Sort field values that contain embedded blank spaces should be enclosed in single quotation marks.
- Any sort field value that you do specify in the ACROSS COLUMNS AND phrase is included in the report, whether or not there is data.
- When using a COMPUTE with an ACROSS COLUMNS phrase, the COLUMNS should be specified last:

```
ACROSS acrossfield [AND] COMPUTE compute_expression; COLUMNS values
```

- Each report request may contain only one ACROSS COLUMNS AND phrase.

Defining Column Sort Sequence

The following illustrates how to sum employee salaries by the bank at which they are automatically deposited, and to define your own label within the sorting sequence for the bank field.

```
TABLE FILE EMPLOYEE
SUM CURR_SAL
ACROSS BANK_NAME COLUMNS 'BEST BANK' AND STATE
    AND ASSOCIATED AND 'BANK ASSOCIATION'
END
```

The output is:

BANK_NAME				
BEST BANK ASSOCIATION	STATE	ASSOCIATED	BANK	

-				
\$29,700.00	\$18,480.00	\$64,742.00	\$27,062.00	

Selecting and Assigning Column Titles to ACROSS Values

When you use the ACROSS COLUMNS phrase to select and order the columns that display on the report output for an ACROSS sort field, you can assign each selected column a new column title using an AS phrase.

Assign Column Titles To ACROSS Values

```
ACROSS sortfield [AS title]
  COLUMNS aval1 [AS val1title] [{AND|OR} aval2 [AS val2title] [...
  {AND|OR} avaln [AS valntitle]]]
```

where:

sortfield

Is the ACROSS field name.

title

Is the title for the ACROSS field name.

AND|OR

Is required to separate the selected ACROSS values. AND and OR are synonyms for this purpose.

aval1, aval2, ... avaln

Are the selected ACROSS values to display on the report output.

val1title, val2title ...valntitle

Are the column titles for the selected ACROSS values.

Usage Notes for Assigning Column Titles to ACROSS Values

- Any value you specify as an ACROSS value in the sort phrase will appear on the report output, even if the value is screened out by an IF or WHERE test, or if the value does not exist at all in the data source.

 **Note:** For styled output formats, SET HIDENULLACRS=ON removes empty columns in ACROSS groups from the report output.

- Column titles for ACROSS fields appear on a single line of the report output.
- Support for AS names for ACROSS values is limited to the TABLE FILE command.
- When you create a HOLD file with SET ASNAMES = ON, the original field name is propagated to the output Master File, *not* the AS name.

Selecting and Assigning Column Titles to ACROSS Values

The following request against the GGSales data source selects the columns **Coffee Grinder**, **Latte**, and **Coffee Pot** for the ACROSS field PRODUCT, and assigns each of them a new column title:

```
TABLE FILE GGSales
SUM
DOLLARS/I8M AS ''
BY REGION
ACROSS PRODUCT AS 'Products'
  COLUMNS 'Coffee Grinder' AS 'Grinder'
  OR Latte AS 'caffellatte'
  AND 'Coffee Pot' AS 'Carafe'
ON TABLE SET PAGE NOPAGE
END
```

The output is:

Region	Products Grinder	caffellatte	Carafe
Midwest	\$666,622	\$2,883,566	\$599,878
Northeast	\$509,200	\$2,808,855	\$590,780
Southeast	\$656,957	\$2,637,562	\$645,303
West	\$603,436	\$2,670,405	\$613,624

Ranking Sort Field Values

When you sort report rows using the BY phrase, you can indicate the numeric rank of each row. Ranking sort field values is frequently combined with restricting sort field values by rank.

Note that it is possible for several report rows to have the same rank if they have identical sort field values.

The default column title for RANKED BY is RANK. You can change the title using an AS phrase. The RANK field has format I7. Therefore, the RANK column in a report can be up to seven digits.

You can rank aggregated values using the syntax RANKED BY TOTAL. For details, see [Sorting and Aggregating Report Columns](#).

Rank Sort Field Values

```
RANKED [AS 'name'] BY {HIGHEST|LOWEST} [n] sortfield [AS 'text']
```

where:

name

Is the new name for the RANK column title.

sortfield

Is the name of the sort field. The field can be numeric or alphanumeric.

n

Is the number of rank categories to display on the report output.

text

Is the column heading to use for the sort field column on the report output.

Ranking Sort Field Values

Issue the following request to display a list of employee names in salary order, indicating the rank of each employee by salary. Note that employees Jones and McCoy have the same rank since their current salary is the same.

```
TABLE FILE EMPLOYEE
PRINT LAST_NAME
RANKED AS 'Sequence' BY CURR_SAL
END
```

The output is:

```
Sequence          CURR_SAL  LAST_NAME
-----          -
```

1	\$9,000.00	GREENSPAN
2	\$9,500.00	SMITH
3	\$11,000.00	STEVENS
4	\$13,200.00	SMITH
5	\$16,100.00	MCKNIGHT
6	\$18,480.00	JONES
		MCCOY
7	\$21,120.00	ROMANS
8	\$21,780.00	BLACKWOOD
9	\$26,862.00	IRVING
10	\$27,062.00	CROSS
11	\$29,700.00	BANNING

<u>Sequence</u>	<u>CURR SAL</u>	<u>LAST NAME</u>
1	\$9,000.00	GREENSPAN
2	\$9,500.00	SMITH
3	\$11,000.00	STEVENS
4	\$13,200.00	SMITH
5	\$16,100.00	MCKNIGHT
6	\$18,480.00	JONES
		MCCOY
7	\$21,120.00	ROMANS
8	\$21,780.00	BLACKWOOD
9	\$26,862.00	IRVING
10	\$27,062.00	CROSS
11	\$29,700.00	BANNING

Ranking and Restricting Sort Field Values

Ranking sort field values is frequently combined with restricting sort field values by rank, as in the following example.

```
TABLE FILE EMPLOYEE
PRINT LAST_NAME
RANKED BY HIGHEST 5 CURR_SAL
END
```

The output is:

```
RANK          CURR_SAL  LAST_NAME
-----          -
```

1	\$29,700.00	BANNING
2	\$27,062.00	CROSS
3	\$26,862.00	IRVING
4	\$21,780.00	BLACKWOOD
5	\$21,120.00	ROMANS

DENSE and SPARSE Ranking

The FOCUS sort phrases RANK BY and BY {HIGHEST|LOWEST} n sort the report output and assign rank numbers to the sequence of data values. When assigning a rank to a data value, by default FOCUS does not skip rank numbers. This means that even when multiple data values are assigned the same rank, the rank number for the next group of values is the next sequential integer. This method of assigning rank numbers is called **dense**.

Some of the relational engines assign rank numbers using a method called **sparse**. With sparse ranking, if multiple data values are assigned the same rank number, the next rank number will be the previous rank number plus the number of multiples.

You can use the FOCUS RANK parameter to control the type of ranking done by FOCUS. In addition, if you are accessing a relational data source, you can set the ranking method to the type of ranking done by your relational engine so that the rank calculation can be optimized. Some relational engines have functions for both dense and sparse ranking. In this case, either setting can be optimized.

Optimizing Ranking

In order to pass rank processing to a relational engine your request must:

- Use the SUM (or WRITE or ADD) command to aggregate values.
- Specify the number of rank categories to be displayed. That is, you must specify a value for **n**:

```
[RANKED] BY [HIGHEST] n
```

Control the Ranking Method

```
SET RANK={DENSE| SPARSE}
```

where:

DENSE

Specifies dense ranking. With this method, each rank number is the next sequential integer, even when the same rank is assigned to multiple data values. DENSE is the default value.

SPARSE

Specifies sparse ranking. With this method, if the same rank number is assigned to multiple data values, the next rank number will be the previous rank number plus the number of multiples.

Then, in your request, use one of the following forms of the BY phrase:

```
RANKED BY {HIGHEST|LOWEST} [n] sortfield [AS 'text']
```

or

```
BY {HIGHEST|LOWEST} n sortfield [AS 'text']
```

where:

n

Is the highest rank number to display on the report output when the RANKED BY phrase is used. When RANKED is not used, it is the number of distinct sort field values to display on the report output when SET RANK=DENSE, and the total number of lines of output for the sort field when SET RANK=SPARSE.

sortfield

Is the name of the sort field.

text

Is the column heading to be used for the sort field column on the report output.

Usage Notes for SET RANK

- The RNK. prefix operator is not affected by the RANK parameter.
- The rank numbers propagated to a HOLD file depend on the RANK parameter setting.

Ranking Values in a ibi FOCUS Data Source

The following request against the EMPDATA data source ranks salaries in descending order by division. The RANK parameter is set to DENSE (the default).

```
SET RANK = DENSE
TABLE FILE EMPDATA
PRINT LASTNAME FIRSTNAME
RANKED BY HIGHEST 12 SALARY
BY DIV
ON TABLE SET PAGE NOPAGE
END
```

On the output, six employees are included in rank number 6. With dense ranking, the next rank number is the next highest integer, 7.

RANK	SALARY	DIV	LASTNAME	FIRSTNAME
1	\$115,000.00	CE	LASTRA	KAREN
2	\$83,000.00	CORP	SANCHEZ	EVELYN
3	\$80,500.00	SE	NOZAWA	JIM
4	\$79,000.00	CORP	SOPENA	BEN
5	\$70,000.00	WE	CASSANOVA	LOIS
6	\$62,500.00	CE	ADAMS	RUTH
		CORP	CVEK	MARCUS
			WANG	JOHN
		NE	WHITE	VERONICA
		SE	BELLA	MICHAEL
			HIRSCHMAN	ROSE
7	\$58,800.00	WE	GOTLIEB	CHRIS
8	\$55,500.00	CORP	VALINO	DANIEL
		NE	PATEL	DORINA
9	\$54,100.00	CE	ADDAMS	PETER
		WE	FERNSTEIN	ERWIN
10	\$52,000.00	NE	LIEBER	JEFF
11	\$50,500.00	SE	LEWIS	CASSANDRA

12	\$49,500.00	CE	ROSENTHAL	KATRINA
		SE	WANG	KATE

Running the same request with SET RANK=SPARSE produces the following output. Since rank category 6 includes six employees, the next rank number is 6 + 6.

RANK	SALARY	DIV	LASTNAME	FIRSTNAME
----	-----	---	-----	-----
1	\$115,000.00	CE	LASTRA	KAREN
2	\$83,000.00	CORP	SANCHEZ	EVELYN
3	\$80,500.00	SE	NOZAWA	JIM
4	\$79,000.00	CORP	SOPENA	BEN
5	\$70,000.00	WE	CASSANOVA	LOIS
6	\$62,500.00	CE	ADAMS	RUTH
		CORP	CVEK	MARCUS
			WANG	JOHN
		NE	WHITE	VERONICA
		SE	BELLA	MICHAEL
			HIRSCHMAN	ROSE
12	\$58,800.00	WE	GOTLIEB	CHRIS

Limiting the Number of Sort Field Values

The following request against the EMPDATA data source sorts salaries in descending order by division and prints the 12 highest salaries. The RANK parameter is set to DENSE (the default).

```
SET RANK = DENSE
TABLE FILE EMPDATA
PRINT LASTNAME FIRSTNAME
BY HIGHEST 12 SALARY
BY DIV
ON TABLE SET PAGE NOPAGE
END
```

On the output, 12 distinct salary values are displayed, even though some of the employees have the same salaries.

SALARY	DIV	LASTNAME	FIRSTNAME
-----	---	-----	-----

\$115,000.00	CE	LASTRA	KAREN
\$83,000.00	CORP	SANCHEZ	EVELYN
\$80,500.00	SE	NOZAWA	JIM
\$79,000.00	CORP	SOPENA	BEN
\$70,000.00	WE	CASSANOVA	LOIS
\$62,500.00	CE	ADAMS	RUTH
	CORP	CVEK	MARCUS
		WANG	JOHN
	NE	WHITE	VERONICA
	SE	BELLA	MICHAEL
		HIRSCHMAN	ROSE
\$58,800.00	WE	GOTLIEB	CHRIS
\$55,500.00	CORP	VALINO	DANIEL
	NE	PATEL	DORINA
\$54,100.00	CE	ADDAMS	PETER
	WE	FERNSTEIN	ERWIN
\$52,000.00	NE	LIEBER	JEFF
\$50,500.00	SE	LEWIS	CASSANDRA
\$49,500.00	CE	ROSENTHAL	KATRINA
	SE	WANG	KATE

Running the same request with SET RANK=SPARSE produces the following output. Since six employees have salary \$62,500, that value is counted 6 times so that only 12 lines (seven distinct salary values) display on the output.

SALARY	DIV	LASTNAME	FIRSTNAME
-----	---	-----	-----
\$115,000.00	CE	LASTRA	KAREN
\$83,000.00	CORP	SANCHEZ	EVELYN
\$80,500.00	SE	NOZAWA	JIM
\$79,000.00	CORP	SOPENA	BEN
\$70,000.00	WE	CASSANOVA	LOIS
\$62,500.00	CE	ADAMS	RUTH
	CORP	CVEK	MARCUS
		WANG	JOHN
	NE	WHITE	VERONICA
	SE	BELLA	MICHAEL
		HIRSCHMAN	ROSE
\$58,800.00	WE	GOTLIEB	CHRIS

Grouping Numeric Data Into Ranges

When you sort a report using a numeric sort field, you can group the sort field values together and define the range of each group.

There are several ways of defining groups. You can define groups of:

- Equal range using the IN-GROUPS-OF phrase.

Each report request can contain a total of five IN-GROUPS-OF phrases plus IN-RANGES-OF phrases. The IN-GROUPS-OF phrase can only be used once per BY field. The first sort field range starts from the lowest value of a multiple of the IN-GROUPS-OF value, and the value displayed is the start point of each range.

- Equal range using the IN-RANGES-OF phrase.

Each report request can contain a total of five IN-GROUPS-OF phrases plus IN-RANGES-OF phrases. The IN-RANGES-OF phrase can only be used once per BY field, and it generates an additional internal sort phrase that must be counted in the total number of sort phrases. The first sort field range starts from the lowest value of a multiple of the IN-GROUPS-OF value. No message is generated if you specify a range of zero, but the values displayed on the report are unpredictable.

- Unequal range using the FOR phrase.
- Tiles. These include percentiles, quartiles, or deciles. For details, see [Grouping Numeric Data Into Tiles](#).

The FOR phrase is usually used to produce matrix reports and is part of the Financial Modeling Language (FML). However, you can also use it to create columnar reports that group sort field values in unequal ranges.

The FOR phrase displays the sort value for each individual row. The ranges do not have to be contiguous, that is, you can define your ranges with gaps between them. The FOR phrase is described in more detail in [Creating Financial Reports With Financial Modeling Language \(FML\)](#).

i Note: If there is not any data for a group, a row for the group still appears in the report.

Define Groups of Equal Range

```
{BY|ACROSS} sortfield IN-GROUPS-OF value [TOP limit]
```

where:

sortfield

Is the name of the sort field. The sort field must be numeric: its format must be I (integer), F (floating-point number), D (decimal number), or P (packed number).

value

Is a positive integer that specifies the range by which sort field values are grouped.

limit

Is an optional number that defines the highest group label to be included in the report.

Defining Groups of Equal Ranges

The following illustrates how to show which employees fall into which salary ranges, and to define the ranges by \$5,000 increments.

```
TABLE FILE EMPLOYEE
PRINT LAST_NAME
BY CURR_SAL IN-GROUPS-OF 5000
END
```

The output is:

CURR_SAL	LAST_NAME
-----	-----
\$5,000.00	SMITH GREENSPAN
\$10,000.00	STEVENS SMITH
\$15,000.00	JONES MCCOY MCKNIGHT
\$20,000.00	ROMANS BLACKWOOD

```
$25,000.00  BANNING
             IRVING
             CROSS
```

Define Equal Ranges

```
{BY|ACROSS} sortfield IN-RANGES-OF value [TOP limit]
```

where:

sortfield

Is the name of the sort field. The sort field must be numeric: its format must be I (Integer), F (floating-point), D (double-precision), or P (packed).

value

Is an integer greater than zero indicating the range by which sort field values are grouped.

limit

Is an optional number that defines the highest range label to be included in the report. The range is extended to include all data values higher than this value.

i Note: IN-RANGES-OF generates an internal sort phrase that must be counted in the total number of sort phrases.

Defining Equal Ranges

```
TABLE FILE EMPLOYEE
PRINT LAST_NAME
BY CURR_SAL IN-RANGES-OF 5000
END
```

The output is:

CURR_SAL		LAST_NAME
-----		-----
\$5,000.00 -	\$9,999.99	SMITH
		GREENSPAN
\$10,000.00 -	\$14,999.99	STEVENS
		SMITH
\$15,000.00 -	\$19,999.99	JONES
		MCCOY
		MCKNIGHT
\$20,000.00 -	\$24,999.99	ROMANS
		BLACKWOOD
\$25,000.00 -	\$29,999.99	BANNING
		IRVING
		CROSS

<u>CURR_SAL</u>	<u>LAST_NAME</u>
\$5,000.00 - \$9,999.99	SMITH
	GREENSPAN
\$10,000.00 - \$14,999.99	STEVENS
	SMITH
\$15,000.00 - \$19,999.99	JONES
	MCCOY
	MCKNIGHT
\$20,000.00 - \$24,999.99	ROMANS
	BLACKWOOD
\$25,000.00 - \$29,999.99	BANNING
	IRVING
	CROSS

Define Custom Groups of Data Values

```
FOR sortfield
begin1 TO end1 [OVER begin2 TO end2 ... ]
```

where:

sortfield

Is the name of the sort field.

begin

Is a value that identifies the beginning of a range.

end

Is a value that identifies the end of a range.

Defining Custom Groups of Data Values

The following request displays employee salaries, but it groups them in an arbitrary way. Notice that the starting value of each range prints in the report.

```
TABLE FILE EMPLOYEE
PRINT LAST_NAME
FOR CURR_SAL
9000 TO 13500 OVER
14000 TO 19700 OVER
19800 TO 30000
END
```

The output is:

```
          LAST_NAME
          -----
9000    STEVENS
9000    SMITH
9000    SMITH
9000    GREENSPAN
14000   JONES
14000   MCCOY
14000   MCKNIGHT
19800   BANNING
19800   IRVING
19800   ROMANS
19800   BLACKWOOD
19800   CROSS
```

	<u>LAST_NAME</u>
9000	STEVENS
9000	SMITH
9000	SMITH
9000	GREENSPAN
14000	JONES
14000	MCCOY
14000	MCKNIGHT
19800	BANNING
19800	IRVING
19800	ROMANS
19800	BLACKWOOD
19800	CROSS

Grouping Numeric Data Into Tiles

You can group numeric data into any number of tiles (percentiles, deciles, quartiles, etc.) in tabular reports. For example, you can group student test scores into deciles to determine which students are in the top ten percent of the class, or determine which sales representatives are in the top half of all sales representatives based on total sales.

Grouping is based on the values in the selected vertical (BY) field, and data is apportioned as equally as possible into the number of tile groups you specify.

The following occurs when you group data into tiles:

- A new column, labeled TILE by default, is added to the report output and displays the tile number assigned to each instance of the tile field. You can change the column heading with an AS phrase.
- Tiling is calculated within all of the higher-level sort fields in the request, and restarts whenever a sort field at a higher level than the tile field value changes.
- Instances are counted using the tile field. If the request prints fields from lower-level segments, there may be multiple report lines that correspond to one instance of the tile field.
- Instances with the same tile field value are placed in the same tile. For example, consider the following data, which is to be apportioned into three tiles:

1 5 5 5 8 9

In this case, dividing the instances into groups containing an equal number of records produces the following:

Group	Data Values
1	1,5
2	5,5
3	8,9

However, because all of the same data values must be in the same tile, the fives (5) that are in group 2 are moved to group 1. Group 2 remains empty. The final tiles are:

Tile Number	Data Values
1	1,5,5,5
2	
3	8,9

Group Numeric Data Into Tiles

```
BY [ {HIGHEST|LOWEST} [k] ] tilefield [AS 'head1']
   IN-GROUPS-OF n TILES [TOP m] [AS 'head2']
```

where:

HIGHEST

Sorts the data in descending order so that the highest data values are placed in tile 1.

LOWEST

Sorts the data in ascending order so that the lowest data values are placed in tile 1. This is the default sort order.

k

Is a positive integer representing the number of tile groups to display in the report. For example, BY HIGHEST 2 displays the two non-empty tiles with the highest data values.

tilefield

Is the field whose values are used to assign the tile numbers.

head1

Is a heading for the column that displays the values of the tile sort field.

n

Is a positive integer not greater than 32,767, specifying the number of tiles to be used in grouping the data. For example, 100 tiles produce percentiles, while 10 tiles produce deciles.

m

Is a positive integer indicating the highest tile value to display in the report. For example, TOP 3 does not display any data row that is assigned a tile number greater than 3.

head2

Is a new heading for the column that displays the tile numbers.

i Note:

- The syntax accepts numbers that are not integers for k , n , and m . On z/OS, values with decimals are rounded to integers; on UNIX and Windows they are truncated. If the numbers supplied are negative or zero, an error message is generated.
- Both k and m limit the number of rows displayed within each sort break in the report. If you specify both, the more restrictive value controls the display. If k and m are both greater than n (the number of tiles), n is used.

Grouping Data Into Five Tiles

The following illustrates how to group data into five tiles.

<u>DEPARTMENT</u>	<u>CURR SAL</u>	<u>TILE</u>	<u>LAST NAME</u>	<u>FIRST NAME</u>
MIS	\$9,000.00	1	GREENSPAN	MARY
	\$13,200.00	1	SMITH	MARY
	\$18,480.00	2	JONES	DIANE
			MCCOY	JOHN
	\$21,780.00	4	BLACKWOOD	ROSEMARIE
	\$27,062.00	5	CROSS	BARBARA
PRODUCTION	\$9,500.00	1	SMITH	RICHARD
	\$11,000.00	1	STEVENS	ALFRED
	\$16,100.00	2	MCKNIGHT	ROGER
	\$21,120.00	3	ROMANS	ANTHONY
	\$26,862.00	4	IRVING	JOAN
	\$29,700.00	5	BANNING	JOHN

```

TABLE FILE MOVIES
PRINT TITLE
BY CATEGORY
BY LISTPR IN-GROUPS-OF 5 TILES
WHERE CATEGORY EQ 'ACTION' OR 'CHILDREN'
END

```

The output is:

<u>CATEGORY</u>	<u>LISTPR</u>	<u>TILE</u>	<u>TITLE</u>
-----	-----	----	-----
ACTION	14.95	1	TOP GUN
	19.95	2	JAWS
			RAMBO III
	19.98	4	ROBOCOP
	19.99	5	TOTAL RECALL
CHILDREN	14.95	1	SESAME STREET-BEDTIME STORIES AND SONGS
	14.98	1	ROMPER ROOM-ASK MISS MOLLY
	19.95	2	SMURFS, THE
			SCOOBY-DOO-A DOG IN THE RUFF
	26.99	3	BAMBI
	29.95	4	ALICE IN WONDERLAND
			SLEEPING BEAUTY
	44.95	5	SHAGGY DOG, THE

Note that the tiles are assigned within the higher-level sort field CATEGORY. The ACTION category does not have any data assigned to tile 3. The CHILDREN category has all five tiles.

Displaying the First Three Tile Groups

<u>DEPARTMENT</u>	<u>CURR SAL</u>	<u>TILE</u>	<u>LAST NAME</u>	<u>FIRST NAME</u>
MIS	\$9,000.00	1	GREENSPAN	MARY
	\$13,200.00	1	SMITH	MARY
	\$18,480.00	2	JONES	DIANE
			MCCOY	JOHN
PRODUCTION	\$21,780.00	4	BLACKWOOD	ROSEMARIE
	\$9,500.00	1	SMITH	RICHARD
	\$11,000.00	1	STEVENS	ALFRED
	\$16,100.00	2	MCKNIGHT	ROGER
	\$21,120.00	3	ROMANS	ANTHONY

The following request prints only the first three tiles in each category:

```
TABLE FILE MOVIES
PRINT TITLE
BY CATEGORY
BY LOWEST 3 LISTPR IN-GROUPS-OF 5 TILES
WHERE CATEGORY EQ 'ACTION' OR 'CHILDREN'
END
```

The output is:

<u>CATEGORY</u>	<u>LISTPR</u>	<u>TILE</u>	<u>TITLE</u>
-----	-----	----	-----
ACTION	14.95	1	TOP GUN
	19.95	2	JAWS
			RAMBO III
CHILDREN	19.98	4	ROBOCOP
	14.95	1	SESAME STREET-BEDTIME STORIES AND SONGS
	14.98	1	ROMPER ROOM-ASK MISS MOLLY
	19.95	2	SMURFS, THE
			SCOOBY-DOO-A DOG IN THE RUFF
	26.99	3	BAMBI

Note that the request displays three tile groups in each category. Because no data was assigned to tile 3 in the ACTION category, tiles 1, 2, and 4 display for that category.

Displaying Tiles With a Value of Three or Less

<u>DEPARTMENT</u>	<u>CURR SAL</u>	<u>DECILE</u>	<u>LAST NAME</u>	<u>FIRST NAME</u>
MIS	\$9,000.00	1	GREENSPAN	MARY
	\$13,200.00	1	SMITH	MARY
	\$18,480.00	2	JONES	DIANE
PRODUCTION			MCCOY	JOHN
	\$9,500.00	1	SMITH	RICHARD
	\$11,000.00	1	STEVENS	ALFRED
	\$16,100.00	2	MCKNIGHT	ROGER
	\$21,120.00	3	ROMANS	ANTHONY

In the following request, the TOP 3 phrase restricts the display to tile numbers less than or equal to 3:

```
TABLE FILE MOVIES
PRINT TITLE
BY CATEGORY
BY LOWEST 3 LISTPR IN-GROUPS-OF 5 TILES TOP 3
WHERE CATEGORY EQ 'ACTION' OR 'CHILDREN'
END
```

The output is:

<u>CATEGORY</u>	<u>LISTPR</u>	<u>TILE</u>	<u>TITLE</u>
-----	-----	----	-----
ACTION	14.95	1	TOP GUN
	19.95	2	JAWS
			RAMBO III
CHILDREN	14.95	1	SESAME STREET-BEDTIME STORIES AND SONGS
	14.98	1	ROMPER ROOM-ASK MISS MOLLY
	19.95	2	SMURFS, THE
			SCOOBY-DOO-A DOG IN THE RUFF
	26.99	3	BAMBI

Because no data was assigned to tile 3 in the ACTION category, only tiles 1 and 2 display for that category.

Grouping Data Into Tiles and Customizing Column Headings

The following request changes the column headings for both the LISTPR and TILE columns:

```
TABLE FILE MOVIES
PRINT TITLE
BY CATEGORY
BY LISTPR AS 'PRICE' IN-GROUPS-OF 10 TILES TOP 3 AS 'DECILE'
WHERE CATEGORY EQ 'ACTION' OR 'CHILDREN'
END
```

The output is:

CATEGORY	PRICE	DECILE	TITLE
-----	-----	-----	-----
ACTION	14.95	1	TOP GUN
	19.95	3	JAWS
			RAMBO III
CHILDREN	14.95	1	SESAME STREET-BEDTIME STORIES AND SONGS
	14.98	2	ROMPER ROOM-ASK MISS MOLLY
	19.95	3	SMURFS, THE SCOOBY-DOO-A DOG IN THE RUFF

Usage Notes for Tiles

- If a request retrieves data from segments that are descendants of the segment containing the tile field, multiple report rows may correspond to one instance of the tile field. These additional report rows do not affect the number of instances used to assign the tile values. However, if you retrieve fields from multiple segments and create a single-segment output file, this flat file will have multiple instances of the tile field, and this increased number of instances may affect the tile values assigned. Therefore, when you run the same request against the multi-level file and the single-segment file, different tile assignments may result.
- Tiles are always calculated on a BY sort field in the request.
- Only one tiles calculation is supported per request. However, the request can contain up to five (the maximum allowed) non-tile IN-GROUP-OF phrases in addition to the TILES phrase.
- Comparisons for the purpose of assigning tile numbers use exact data values regardless of their display format. Therefore, if you display a floating-point value as D7, you may not be showing enough significant digits to indicate why values are placed in separate tiles.

- The tile field can be a real field or a virtual field created with a DEFINE command or a DEFINE in the Master File. The COMPUTE command cannot be used to create a tile field.
- Empty tiles do not display in the report output.
- In requests with multiple sort fields, tiles are supported only at the lowest level and only with the BY LOWEST phrase.
- Tiles are supported with output files. However, the field used to calculate the tiles propagates three fields to a HOLD file (the actual field value, the tile, and a ranking field) unless you set HOLDLIST to PRINTONLY.
- Tiles are not supported with BY TOTAL, TABLEF, FML, and GRAPH.

Restricting Sort Field Values by Highest/Lowest Rank

When you sort report rows using the BY phrase, you can restrict the sort field values to a group of high or low values. You choose the number of fields to include in the report. For example, you can choose to display only the 10 highest (or lowest) sort field values in your report by using BY HIGHEST (or LOWEST).

You can have up to five sort fields with BY HIGHEST or BY LOWEST.

Restrict Sort Field Values by Highest/Lowest Rank

```
BY {HIGHEST n|LOWEST n} sortfield
```

where:

HIGHEST n

Specifies that only the highest *n* sort field values are included in the report. TOP is a synonym for HIGHEST.

LOWEST n

Specifies that only the lowest n sort field values are included in the report.

sortfield

Is the name of the sort field. The sort field can be numeric or alphanumeric.

i Note: HIGHEST/LOWEST n refers to the number of sort field values, not the number of report rows. If several records have the same sort field value that satisfies the HIGHEST/LOWEST n criteria, all of them are included in the report.

Restricting Sort Field Values to a Group

The following request displays the names of the employees earning the five highest salaries.

```
TABLE FILE EMPLOYEE
PRINT LAST_NAME
BY HIGHEST 5 CURR_SAL
END
```

The output is:

```
      CURR_SAL  LAST_NAME
      -----  -
$29,700.00    BANNING
$27,062.00    CROSS
$26,862.00    IRVING
$21,780.00    BLACKWOOD
$21,120.00    ROMANS
```

<u>CURR SAL</u>	<u>LAST NAME</u>
\$29,700.00	BANNING
\$27,062.00	CROSS
\$26,862.00	IRVING
\$21,780.00	BLACKWOOD
\$21,120.00	ROMANS

Sorting and Aggregating Report Columns

Using the BY TOTAL phrase, you can apply aggregation and sorting simultaneously to numeric columns in your report in one pass of the data. For BY TOTAL to work correctly, you must have an aggregating display command such as SUM. A non-aggregating display command, such as PRINT, simply retrieves the data without aggregating it. Records are sorted in either ascending or descending sequence, based on your query. Ascending order is the default.

You can also use the BY TOTAL phrase to sort based on temporary values calculated by the COMPUTE command.

i **Note:** On z/OS, the sort on the aggregated value is calculated using an external sort package, even if EXTSORT = OFF.

Sort and Aggregate a Report Column

```
[RANKED] BY [HIGHEST|LOWEST [n] ]
          TOTAL {display_field|COMPUTE name/format=expression;}
```

or

```
[RANKED] BY TOTAL {[HIGHEST|LOWEST [n] ]
                   display_field|COMPUTE name/format=expression;}
```

where:

RANKED

Adds a column to the report in which a rank number is assigned to each aggregated sort value in the report output. If multiple rows have the same ranking, the rank number only appears in the first row.

n

Is the number of sort field values you wish to display in the report. If *n* is omitted, all values of the calculated sort field are displayed. The default order is from lowest to highest.

display_field

Can be a field name, a field name preceded by an operator (that is, prefixoperator.fieldname), or a calculated value.

A BY TOTAL field is treated as a display field when the internal matrix is created. After the matrix is created, the output lines are aggregated and re-sorted based on all of the sort fields.

Sorting and Aggregating Report Columns

	HIGHEST			SALARY
	AVERAGE			
<u>DEPARTMENT</u>	<u>SALARIES</u>	<u>CURR_JOBCODE</u>	<u>SALARY</u>	<u>COUNT</u>
MIS	\$26,418.50	A17	\$52,837.00	2
	\$21,780.00	B04	\$21,780.00	1
PRODUCTION	\$29,700.00	A17	\$29,700.00	1
	\$25,641.00	A15	\$51,282.00	2

In this example, the average of the wholesale prices is calculated and used as a sort field, and the highest two are displayed.

```
TABLE FILE MOVIES
SUM WHOLESALPR CNT.WHOLESALPR
BY CATEGORY
BY HIGHEST 2 TOTAL AVE.WHOLESALPR AS 'AVE.WHOLESALPR'
BY RATING
WHERE CATEGORY EQ 'CLASSIC' OR 'FOREIGN' OR 'MUSICALS'
END
```

The output is:

CATEGORY	AVE.WHOLESALPR	RATING	WHOLESALPR	WHOLESALPR COUNT
-----	-----	-----	-----	-----
CLASSIC	40.99	G	40.99	1
	16.08	NR	160.80	10
FOREIGN	31.00	PG	62.00	2
	23.66	R	70.99	3
MUSICALS	15.00	G	15.00	1
	13.99	PG	13.99	1
		R	13.99	1

Sorting, Aggregating, and Ranking Report Columns

<u>DEPARTMENT</u>	<u>RANK</u>	HIGHEST		SALARY	
		<u>AVERAGE</u> <u>SALARIES</u>	<u>CURR</u> <u>JOB</u> <u>CODE</u>	<u>SALARY</u>	<u>COUNT</u>
MIS	1	\$26,418.50	A17	\$52,837.00	2
	2	\$21,780.00	B04	\$21,780.00	1
PRODUCTION	1	\$29,700.00	A17	\$29,700.00	1
	2	\$25,641.00	A15	\$51,282.00	2

In this example, the average of the wholesale prices is calculated and used as a sort field, and the highest two are displayed and ranked.

```
TABLE FILE MOVIES
SUM WHOLESALPR CNT.WHOLESALPR
BY CATEGORY
RANKED BY HIGHEST 2 TOTAL AVE.WHOLESALPR AS 'AVE.WHOLESALPR'
BY RATING
WHERE CATEGORY EQ 'CLASSIC' OR 'FOREIGN' OR 'MUSICALS'
END
```

The output is:

<u>CATEGORY</u>	<u>RANK</u>	<u>AVE.WHOLESALPR</u>	<u>RATING</u>	<u>WHOLESALPR</u>	<u>WHOLESALPR</u> <u>COUNT</u>
CLASSIC	1	40.99	G	40.99	1
	2	16.08	NR	160.80	10
FOREIGN	1	31.00	PG	62.00	2
	2	23.66	R	70.99	3
MUSICALS	1	15.00	G	15.00	1
	2	13.99	PG	13.99	1
			R	13.99	1

Sorting and Aggregating Report Columns With COMPUTE

	HIGHEST MONTHLY			SALARY
<u>DEPARTMENT</u>	<u>SALARIES</u>	<u>CURR_JOBCODE</u>	<u>SALARY</u>	<u>COUNT</u>
MIS	\$4,403.08	A17	\$52,837.00	2
	\$3,019.17	B03	\$36,230.00	2
PRODUCTION	\$4,273.50	A15	\$51,282.00	2
	\$2,591.67	B02	\$31,100.00	2

In this example, the monthly salary is calculated using a COMPUTE within a sort field. The two highest monthly salaries are displayed.

```
TABLE FILE EMPLOYEE
SUM SALARY CNT.SALARY
BY DEPARTMENT
BY HIGHEST 2 TOTAL COMPUTE MONTHLY_SALARY/D12.2M=SALARY/12;
AS 'HIGHEST,MONTHLY,SALARIES'
BY CURR_JOBCODE
END
```

The output is:

DEPARTMENT	HIGHEST MONTHLY SALARIES	CURR_JOBCODE	SALARY	SALARY COUNT
-----	-----	-----	-----	-----
MIS	\$4,403.08	A17	\$52,837.00	2
	\$3,019.17	B03	\$36,230.00	2
PRODUCTION	\$4,273.50	A15	\$51,282.00	2
	\$2,591.67	B02	\$31,100.00	2

Using BY TOTAL on a Calculated Value With an ACROSS Phrase

The following request creates the calculated value PROFIT and uses it in the BY TOTAL phrase. The request also has an ACROSS RATING phrase.

```

TABLE FILE MOVIES
SUM LISTPR WHOLESALPR
COMPUTE
PROFIT = LISTPR - WHOLESALPR;
BY CATEGORY
BY TOTAL PROFIT
ACROSS RATING
WHERE RATING NE 'NR' OR 'R'
ON TABLE SET PAGE NOLEAD
ON TABLE SET STYLE *GRID = OFF,$
ENDSTYLE
END

```

The output is shown in the following image.

CATEGORY	PROFIT	RATING G		PROFIT	PG		PROFIT	PG13		PROFIT
		LISTPR	WHOLESALPR		LISTPR	WHOLESALPR		LISTPR	WHOLESALPR	
ACTION	13.92	.	.	.	34.90	20.98	13.92	.	.	.
CHILDREN	47.40	101.89	54.49	47.40
CLASSIC	48.96	89.95	40.99	48.96
COMEDY	58.12	.	.	.	74.83	46.70	28.13	59.99	30.00	29.99
FOREIGN	64.63	19.98	13.25	6.73	119.90	62.00	57.90	.	.	.
MUSICALS	25.93	29.95	15.00	14.95	19.98	13.99	5.99	14.98	9.99	4.99
MYSTERY	32.94	.	.	.	39.96	18.00	21.96	19.98	9.00	10.98
SCLFI	18.94	54.93	35.99	18.94	.

Usage Notes for BY TOTAL

- When you use BY HIGHEST/LOWEST *n* with BY TOTAL HIGHEST/LOWEST *n*, the BY TOTAL phrase works on the result of the BY phrase (that is, on the *n* rows that result from the BY phrase).

Restricting the Number of Columns in a Report

The number of columns created by ACROSS depends on the number of:

- Fields displayed in the report, since the maximum width of a report is 32K bytes.
- Values for each of these fields.
- ACROSS and ACROSS-TOTAL phrases in the request.

Row totals, BY columns, SUBHEADs, SUBFOOTs, and fields used in headings and footings do not count in calculating the number of ACROSS columns.

Hiding Sort Values

When you sort a report, you can omit the sort field value itself from the report by using the phrase NOPRINT. This can be helpful in several situations; for instance, when you use the same field as a sort field and a display field, or when you want to sort by a field but not display its values in the report output.

Hide Sort Values

```
{BY|ACROSS} sortfield {NOPRINT|SUP-PRINT}
```

where:

sortfield

Is the name of the sort field.

You can use SUP-PRINT as a synonym for NOPRINT.

Hiding Sort Values

<u>LAST NAME</u>	<u>FIRST NAME</u>	<u>HIRE DATE</u>
STEVENS	ALFRED	80/06/02
SMITH	MARY	81/07/01
JONES	DIANE	82/05/01
SMITH	RICHARD	82/01/04
BANNING	JOHN	82/08/01
IRVING	JOAN	82/01/04
ROMANS	ANTHONY	82/07/01
MCCOY	JOHN	81/07/01
BLACKWOOD	ROSEMARIE	82/04/01
MCKNIGHT	ROGER	82/02/02
GREENSPAN	MARY	82/04/01
CROSS	BARBARA	81/11/02

<u>LAST_NAME</u>	<u>FIRST_NAME</u>	<u>HIRE_DATE</u>
STEVENS	ALFRED	80/06/02
SMITH	MARY	81/07/01
MCCOY	JOHN	81/07/01
CROSS	BARBARA	81/11/02
SMITH	RICHARD	82/01/04
IRVING	JOAN	82/01/04
MCKNIGHT	ROGER	82/02/02
BLACKWOOD	ROSEMARIE	82/04/01
GREENSPAN	MARY	82/04/01
JONES	DIANE	82/05/01
ROMANS	ANTHONY	82/07/01
BANNING	JOHN	82/08/01

If you want to display a list of employee names sorted in alphabetical order, the following request is insufficient.

```
TABLE FILE EMPLOYEE
PRINT LAST_NAME FIRST_NAME
END
```

The output lists the names in the order that they were entered into the data source:

```
LAST_NAME      FIRST_NAME
-----
STEVENS        ALFRED
SMITH          MARY
JONES          DIANE
SMITH          RICHARD
BANNING        JOHN
IRVING         JOAN
ROMANS         ANTHONY
MCCOY          JOHN
BLACKWOOD     ROSEMARIE
MCKNIGHT      ROGER
GREENSPAN     MARY
CROSS         BARBARA
```

To list the employee names in alphabetical order, you would sort the report by the LAST_NAME field and hide the sort field occurrence using the phrase NOPRINT.

```
TABLE FILE EMPLOYEE
PRINT LAST_NAME FIRST_NAME
```

```
BY LAST_NAME NOPRINT
END
```

This request generates the desired output:

LAST_NAME	FIRST_NAME
-----	-----
BANNING	JOHN
BLACKWOOD	ROSEMARIE
CROSS	BARBARA
GREENSPAN	MARY
IRVING	JOAN
JONES	DIANE
MCCOY	JOHN
MCKNIGHT	ROGER
ROMANS	ANTHONY
SMITH	MARY
SMITH	RICHARD
STEVENS	ALFRED

Sort Performance Considerations

The sorting procedure analyzes the request being processed and the amount of sort memory available in order to reduce the amount of disk I/O. The sort strategy is controlled by the specifics of the request and the values of the SORTMATRIX and SORTMEMORY parameters.

SORTMATRIX

The SORTMATRIX parameter controls whether to employ in-memory sorting with decreased use of external memory. The syntax is

```
SET SORTMATRIX = {SMALL | LARGE}
```

where:

SMALL

Creates a single sort matrix of up to 2048 rows, and uses a binary search-based insertion sort with aggregation during retrieval. The maximum number of rows in this matrix has

been determined to provide the best performance for this type of sort. If the sort matrix becomes full, it is written to a file called FOCSORT on disk, the in-memory matrix is emptied, and retrieval continues, writing to FOCSORT as many times as necessary. When the end of data is detected, the remaining rows are written to FOCSORT and the merge routine merges all of the sort strings in FOCSORT (which, in extreme cases, may require multiple merge phases), while also completing the aggregation.

LARGE

Creates a large matrix or multiple small matrices in memory, when adequate memory is available as determined by the SORTMEMORY parameter. LARGE is the default value. The goal of this strategy is to do as much sorting as possible in internal memory before writing any records to disk. Whether disk I/O is necessary at all in the sorting process depends on the amount of memory allocated for sorting and the size of the request output. If the amount of SORTMEMORY is not large enough to meaningfully make use of the LARGE strategy, the sort will default to the SMALL strategy. The LARGE strategy greatly reduces the need for disk I/O and, if disk I/O is required after all (for very large output), it virtually eliminates the need for multiple merge phases.

SORTMEMORY

The SORTMEMORY parameter controls the amount of internal memory available for sorting. The syntax is

```
SET SORTMEMORY = {n|512}
```

where:

n

Is the positive number of megabytes of memory available for sorting. The default value is 512.

Sorting With Multiple Display Commands

A request can consist of up to 64 sets of separate display commands (also known as verb phrases), each with its own sort conditions. In order to display all of the information, a meaningful relationship has to exist among the separate sort condition sets. The following rules apply:

- Up to 64 display commands and their associated sort conditions can be used. The

first display command does not have to have any sort condition. Only the last display command may be a detail command, such as PRINT or LIST. Other preceding display commands must be aggregating commands.

- WHERE and IF criteria apply to the records selected for the report as a whole. WHERE and IF criteria are explained in [Selecting Records for Your Report](#).
- When a sort phrase is used with a display command, the display commands following it must use the same sorting condition in the same order. For example:

```
TABLE FILE EMPLOYEE
SUM ED_HRS
SUM CURR_SAL CNT.CURR_SAL
BY DEPARTMENT
PRINT FIRST_NAME
BY DEPARTMENT
BY LAST_NAME
END
```

The first SUM does not have a sort condition. The second SUM has a sort condition: BY DEPARTMENT. Because of this sort condition, the PRINT command must have BY DEPARTMENT as the first sort condition, and other sort conditions may be added as needed.

Using Multiple Display and Sort Fields

The following request summarizes several levels of detail in the data source.

```
TABLE FILE EMPLOYEE
SUM CURR_SAL
SUM CURR_SAL BY DEPARTMENT
SUM CURR_SAL BY DEPARTMENT BY LAST_NAME
END
```

The command SUM CURR_SAL calculates the total amount of current salaries; SUM CURR_SAL BY DEPARTMENT calculates the total amounts of current salaries in each department; SUM CURR_SAL BY DEPARTMENT BY LAST_NAME calculates the total amounts of current salaries for each employee name.

The output is:

CURR_SAL	DEPARTMENT	CURR_SAL	LAST_NAME	CURR_SAL
-----	-----	-----	-----	-----
\$222,284.00	MIS	\$108,002.00	BLACKWOOD	\$21,780.00
			CROSS	\$27,062.00
			GREENSPAN	\$9,000.00
			JONES	\$18,480.00
			MCCOY	\$18,480.00
			SMITH	\$13,200.00
	PRODUCTION	\$114,282.00	BANNING	\$29,700.00
			IRVING	\$26,862.00
			MCKNIGHT	\$16,100.00
			ROMANS	\$21,120.00
			SMITH	\$9,500.00
			STEVENS	\$11,000.00

<u>CURR_SAL</u>	<u>DEPARTMENT</u>	<u>CURR_SAL</u>	<u>LAST_NAME</u>	<u>CURR_SAL</u>
\$222,284.00	MIS	\$108,002.00	BLACKWOOD	\$21,780.00
			CROSS	\$27,062.00
			GREENSPAN	\$9,000.00
			JONES	\$18,480.00
			MCCOY	\$18,480.00
			SMITH	\$13,200.00
	PRODUCTION	\$114,282.00	BANNING	\$29,700.00
			IRVING	\$26,862.00
			MCKNIGHT	\$16,100.00
			ROMANS	\$21,120.00
			SMITH	\$9,500.00
			STEVENS	\$11,000.00

Controlling Formatting of Reports With Multiple Display Commands

You can use the SET DUPLICATECOL command to reformat report requests that use multiple display commands, placing aggregated fields in the same column above the displayed field.

By default, each new display command in a request generates additional sort field and display field columns. With DUPLICATECOL set to OFF, each field occupies only one column in the request, with the values from each display command stacked under the values for the previous display command.

Control the Format of Reports With Multiple Display Commands

```
SET DUPLICATECOL={ON|OFF}
```

where:

ON

Displays the report with each field as a column. This is the default value.

OFF

Displays the report with common fields as a row.

Displaying Reports With Multiple Display Commands

The following request sums current salaries and education hours for the entire EMPLOYEE data source and for each department:

```
TABLE FILE EMPLOYEE
SUM CURR_SAL ED_HRS
SUM CURR_SAL ED_HRS BY DEPARTMENT
END
```

With DUPLICATECOL=ON, the output has separate columns for the grand totals and for the departmental totals:

CURR_SAL	ED_HRS	DEPARTMENT	CURR_SAL	ED_HRS
-----	-----	-----	-----	-----
\$222,284.00	351.00	MIS	\$108,002.00	231.00
		PRODUCTION	\$114,282.00	120.00

With DUPLICATECOL=OFF, the output has one column for each field. The grand totals are on the top row of the report, and the departmental totals are on additional rows below the grand totals:

DEPARTMENT	CURR_SAL	ED_HRS
-----	-----	-----

	\$222,284.00	351.00
MIS	\$108,002.00	231.00
PRODUCTION	\$114,282.00	120.00

The following request adds a PRINT command sorted by department and by last name to the previous request:

```
SET SPACES = 1
TABLE FILE EMPLOYEE
SUM CURR_SAL ED_HRS
SUM CURR_SAL ED_HRS BY DEPARTMENT AS 'DEPT'
PRINT FIRST_NAME CURR_SAL ED_HRS BY DEPARTMENT BY LAST_NAME
END
```

With DUPLICATECOL=ON, the output has separate columns for the grand totals, for the departmental totals, and for each last name:

CURR_SAL	ED_HRS	DEPT	CURR_SAL	ED_HRS	LAST_NAME	FIRST_NAME	CURR_SAL	ED_HRS
\$222,284.00	351.00	MIS	\$108,002.00	231.00	BLACKWOOD	ROSEMARIE	\$21,780.00	75.00
					CROSS	BARBARA	\$27,062.00	45.00
					GREENSPAN	MARY	\$9,000.00	25.00
					JONES	DIANE	\$18,480.00	50.00
					MCCOY	JOHN	\$18,480.00	.00
					SMITH	MARY	\$13,200.00	36.00
		PRODUCTION	\$114,282.00	120.00	BANNING	JOHN	\$29,700.00	.00
					IRVING	JOAN	\$26,862.00	30.00
					MCKNIGHT	ROGER	\$16,100.00	50.00
					ROMANS	ANTHONY	\$21,120.00	5.00
					SMITH	RICHARD	\$9,500.00	10.00
					STEVENS	ALFRED	\$11,000.00	25.00

With DUPLICATECOL=OFF, the output has one column for each field. The grand totals are on the top row of the report, the departmental totals are on additional rows below the grand totals, and the values for each last name are on additional rows below their departmental totals:

DEPT	LAST_NAME	FIRST_NAME	CURR_SAL	ED_HRS
			\$222,284.00	351.00
MIS			\$108,002.00	231.00
	BLACKWOOD	ROSEMARIE	\$21,780.00	75.00
	CROSS	BARBARA	\$27,062.00	45.00
	GREENSPAN	MARY	\$9,000.00	25.00
	JONES	DIANE	\$18,480.00	50.00
	MCCOY	JOHN	\$18,480.00	.00
	SMITH	MARY	\$13,200.00	36.00
PRODUCTION			\$114,282.00	120.00
	BANNING	JOHN	\$29,700.00	.00
	IRVING	JOAN	\$26,862.00	30.00

MCKNIGHT	ROGER	\$16,100.00	50.00
ROMANS	ANTHONY	\$21,120.00	5.00
SMITH	RICHARD	\$9,500.00	10.00
STEVENS	ALFRED	\$11,000.00	25.00

Style a Report With SET DUPLICATECOL=ON

In a StyleSheet, you can identify the rows you want to style by specifying which display command created those rows:

```
VERBSET = n
```

where:

n

Is the ordinal number of the display command in the report request.

Styling Rows Associated With a Specific Display Command

The following request has two display commands:

1. SUM CURR_SAL ED_HRS BY DEPARTMENT (totals by department).
2. PRINT FIRST_NAME CURR_SAL ED_HRS BY DEPARTMENT BY LAST_NAME (values by employee by department).

```
SET DUPLICATECOL = OFF
TABLE FILE EMPLOYEE
SUM CURR_SAL ED_HRS BY DEPARTMENT
PRINT FIRST_NAME CURR_SAL ED_HRS BY DEPARTMENT BY LAST_NAME
ON TABLE HOLD FORMAT HTML
ON TABLE SET STYLE *
TYPE = REPORT, COLUMN= P4, VERBSET = 1, STYLE = ITALIC, COLOR=BLUE,$
TYPE = REPORT, COLUMN= B2, VERBSET = 2, STYLE = UNDERLINE, COLOR = RED,$
ENDSTYLE
END
```

On the output:

- The fourth displayed column (P4, department total of CURR_SAL) for the SUM command is italic and blue.
- The second BY field (LAST_NAME) for the PRINT command is underlined and red.

When you style specific columns, using P notation means that you count every column that displays on the report output, including BY columns. Therefore, P1 is the DEPARTMENT column, P2 is the LAST_NAME column (this is also B2, the second BY field column), P3 is the FIRST_NAME column, P4 is the displayed version of the CURR_SAL column (the internal matrix has multiple CURR_SAL columns), and P5 is the displayed ED_HRS column (the internal matrix has multiple ED_HRS columns).

The output is:

PAGE 1				
DEPARTMENT	LAST_NAME	FIRST_NAME	CURR_SAL	ED_HRS
MIS			<i>\$108,002.00</i>	231.00
	<u>BLACKWOOD</u>	ROSEMARIE	\$21,780.00	75.00
	<u>CROSS</u>	BARBARA	\$27,062.00	45.00
	<u>GREENSPAN</u>	MARY	\$9,000.00	25.00
	<u>JONES</u>	DIANE	\$18,480.00	50.00
	<u>MCCOY</u>	JOHN	\$18,480.00	.00
	<u>SMITH</u>	MARY	\$13,200.00	36.00
PRODUCTION			<i>\$114,282.00</i>	120.00
	<u>BANNING</u>	JOHN	\$29,700.00	.00
	<u>IRVING</u>	JOAN	\$26,862.00	30.00
	<u>MCKNIGHT</u>	ROGER	\$16,100.00	50.00
	<u>ROMANS</u>	ANTHONY	\$21,120.00	5.00
	<u>SMITH</u>	RICHARD	\$9,500.00	10.00
	<u>STEVENS</u>	ALFRED	\$11,000.00	25.00

Stacking Duplicate Columns in Multi-Verb Requests Based on AS Names

You can use the SET DUPLICATECOL command to reformat report requests that use multiple display commands, placing aggregated fields in the same column above the displayed field.

By default, each new display command in a request generates additional sort field and display field columns. With DUPLICATECOL set to OFF, each field occupies only one column in the request, with the values from each display command stacked under the values for the previous display command.

In prior releases, the duplicate columns were matched based on field names. Now, fields can also be matched based on AS names. An AS name will not be matched to a field name. When a field has an AS name, it will only be matched to other fields that have the same AS name.

Stacking Duplicate Columns in Multi-Verb Requests Based on AS Names

The following request has three display commands. The first sums the CURR_SAL field. The second sums the SALARY field by department. The third prints the GROSS field by department and last name. Each field is assigned the same AS name, even the CURR_SAL field.

```
TABLE FILE EMPLOYEE
SUM CURR_SAL AS CURR_SAL ED_HRS
SUM SALARY AS CURR_SAL ED_HRS BY DEPARTMENT AS 'DEPT'
PRINT FIRST_NAME GROSS AS CURR_SAL ED_HRS BY DEPARTMENT BY LAST_NAME
ON TABLE SET DUPLICATECOL OFF
ON TABLE SET PAGE NOLEAD
ON TABLE SET STYLE *
GRID=OFF, SIZE=10, $
VERBSET=1, COLOR=RED,$
VERBSET=2, COLOR=BLUE,$
VERBSET=3,COLOR=BLACK,$
ENDSTYLE
END
```

The partial output is shown in the following image.

<u>DEPT</u>	<u>LAST_NAME</u>	<u>FIRST_NAME</u>	<u>CURR_SAL</u>	<u>ED_HRS</u>
			\$222,284.00	351.00
MIS			\$160,177.00	231.00
	BLACKWOOD	ROSEMARIE	\$1,815.00	75.00
		ROSEMARIE	\$1,815.00	75.00
		ROSEMARIE	\$1,815.00	75.00
		ROSEMARIE	\$1,815.00	75.00
		ROSEMARIE	\$1,815.00	75.00
	CROSS	BARBARA	\$2,255.00	45.00
		BARBARA	\$2,255.00	45.00
		BARBARA	\$2,255.00	45.00
		BARBARA	\$2,255.00	45.00
		BARBARA	\$2,255.00	45.00
		BARBARA	\$2,147.75	45.00
		BARBARA	\$2,147.75	45.00
		BARBARA	\$2,147.75	45.00
		BARBARA	\$2,147.75	45.00
		BARBARA	\$2,147.75	45.00
		BARBARA	\$2,147.75	45.00
	GREENSPAN	MARY	\$750.00	25.00
		MARY	\$750.00	25.00
		MARY	\$750.00	25.00
		MARY	\$720.84	25.00
	JONES	DIANE	\$1,540.00	50.00
		DIANE	\$1,540.00	50.00
		DIANE	\$1,540.00	50.00
		DIANE	\$1,479.50	50.00
	MCCOY	JOHN	\$1,540.00	.00
	SMITH	MARY	\$1,100.00	36.00
		MARY	\$1,100.00	36.00
		MARY	\$1,100.00	36.00
		MARY	\$1,100.00	36.00
		MARY	\$1,100.00	36.00
		MARY	\$1,100.00	36.00
		MARY	\$1,100.00	36.00
		MARY	\$1,100.00	36.00

Improving Efficiency With External Sorts

When a report is generated, by default it is sorted using an internal sorting procedure. This sorting procedure is optimized for reports of up to approximately 180 to 200K, although many factors affect the size of the data that can be handled by the internal sort.

The FOCSORT file used for the internal sort can grow to any size allowed by the operating system running and the available disk space. The user does not have to break a request up to accommodate massive files. In previous releases, the FOCSORT file was limited to 2 GB and the user received a FOC298 message when the FOCUS limit was exceeded. With no limits enforced by FOCUS, the operating system provides whatever warning and error handling it has for the management of a FOCSORT file that exceeds its limits.

You can generate larger reports somewhat faster by using dedicated sorting products, such as SyncSort, or DFSORT.

To use an external sort, the EXTSORT parameter must be ON. Use of a StyleSheet turns off external sorting.

Note that in Mainframe environments, external sorting is supported with the French, Spanish, German, and Scandinavian National Languages (Swedish, Danish, Finnish, and Norwegian). To specify the National Language Support Environment, use the LANG parameter as described in the *ibi™ FOCUS® Developing Applications* manual.

Requirements for External Sorting

You can use the DFSORT and SyncSort external sort products with any TABLE, FML, GRAPH, or MATCH request.

Usage Notes for External Sorting in Non-Mainframe Environments

It is probably best not to use external sort if:

- Your request requires a matrix (which cannot be converted to a TABLEF request). If your request needs a matrix and uses external sort, it will go through two sorts, both

external and internal, and it will be hard to realize any performance gains.

To tell if your report is convertible to TABLEF, use ? STAT (as described in [Query the Sort Type](#)) or run an abbreviated version of the request with a low record limit and external sort on. If the report statistics are printed after the TABLE output, it was performed as TABLEF; if the statistics are printed before the first screen of TABLE output, it went through TABLE processing because it was not convertible to TABLEF.

- Your input is sorted or almost sorted.
- Your system cannot support a large number of work files (for more information, see [Sort Work Files and Return Codes](#)). In this case the internal sort may do a better job since internally it implements about 60 logical work files, all sharing space in FOCSORT.

Determine the Type of Sort Used

To determine which sort is used, the following criteria are evaluated, in this sequence:

Procedure

1. **BINS.** If an entire report can be sorted within the work area (BINS), the external sort is not invoked, even if EXTSORT is set ON.
2. **EXTERNAL.** If BINS is not large enough to sort the entire report and EXTSORT is set ON, the external sort utility will be invoked.

Control External Sorting

You can turn the external sorting feature on and off using the SET EXTSORT command.

```
SET EXTSORT = {ON|OFF}
```

where:

ON

Enables the selective use of a dedicated external sorting product to sort reports. This value is the default.

OFF

Uses the internal sorting procedure to sort all reports.

Query the Sort Type

To determine which sort is being used for a given report, issue the following command after the report request:

```
? STAT
```

The command displays the following values for the SORT USED parameter:

FOCUS

The internal sorting procedure was used to sort the entire report.

SQL

You are using a relational data source and the RDBMS supplied data already in order.

EXTERNAL

An external sorting product sorted the report.

NONE

The report did not require sorting.

Providing an Estimate of Input Records or Report Size for Sorting

There are two advantages to providing an estimate for the input size (ESTRECORDS) or the report size (ESTLINES):

- If the request cannot be converted to a TABLEF request and the file size estimate shows that the external sort will be needed, FOCUS® initiates the external sort immediately, which makes a FOCUS merge unnecessary. Without the estimate, such a request always performs this merge.

- In Mainframe environments, FOCUS passes the file size to the external sort, which enables it to allocate work files of the appropriate size.

Provide an Estimate of Input Records or Report Size for Sorting

From the command line:

```
SET ESTRECORDS = nSET ESTLINES = n
```

In a request:

```
ON TABLE SET ESTRECORDS nON TABLE SET ESTLINES n
```

where:

n

Is the estimated number of records or lines to be sorted.

i **Note:** These parameters cannot be set in FOCPARM.

Sort Work Files and Return Codes

In non-Mainframe environments, external sorts use temporary work files to hold intermediate sorting results. For each type of external sort, you must be aware of how sort work files are created and used.

Sort Work Files on UNIX, Windows, and OpenVMS

While internal sorting uses only one work file, FOCSORT (allocated in the EDATEMP directory), external sort allows up to 31 work files, allocated on one or more disk drives (spindles) or directories.

 **Warning:** Any one or more of these work files may become very large. Count on using many times the total disk space required by FOCSORT.

By default, five work files are allocated in the /tmp directory on UNIX, or in the directory pointed to by the TMP environment variable in Windows. This may not be enough sort work space and, even if the files fit in the directory, five files are probably not enough for optimal performance. Also, having all of the sort work files on the same disk may further degrade performance.

You have two other options:

- Define the TMPDIR shell variable (UNIX) or TMP environment variable (Windows) to point to some suitable writable directory. For best results, this directory should be on a disk with a lot of available space, and not the same disk as the data source or the EDATEMP directory. Again, you will get five temporary work files allocated on the same spindle, with consequent performance degradation.
- Define 1 to 31 shell variables of the form IBITMPDIR01 ... IBITMPDIR31 to point to one or more writable directories.

If the UNIX TMPDIR or Windows TMP variable is set, it must be "unset" in order to make use of the IBITMPDIR nn variables. The UNIX command for unsetting the TMPDIR variable is:

```
unset TMPDIR
```

The Windows command for unsetting the TMP variable is:

```
SET TMP=
```

Different variables may point to the same directory, if desired. If you wish to allocate n work files, you must define variables 01 through n . The first variable missing from the environment determines the number of work files that will be used. (If you define

fewer than five, additional files will be allocated using the system default location to make up the difference.) The more work files you allocate, and the more separated they are across different spindles, the better performance you should achieve. The major constraint is the total disk space available.

The work file names are generated by the ANSI tempnam function, however, the names all begin with the characters *srtwk*. If the sorting process ends normally or terminates because of a detectable error (typically, disk space overflow), all of the allocated work files are deleted. There is no explicit way to save them. If there is another type of abnormal termination, *srtwk* files may be left on the disk. You can and should erase them.

Sort Work Files on IBM i

On IBM i (formerly i5/OS), the number of work files is fixed at 9. They are virtual files.

WebFOCUS External Sort Return Codes

The WebFOCUS error message FOC909 is issued for all errors from external sort. An additional three-digit code is supplied, of which the last two digits are of interest. If you get an error number ending in:

- 16, external sort did not have enough memory allocated. You can try reducing the number of work files.
- 20, an I/O error occurred; in most cases, this means that one of the disks is not writable or has overflowed. Allocate the work files differently or reduce their number.
- 28, one of the work files could not be opened. Check to make sure the pathname was specified correctly and that protections allow writing and reading.
- 32, an internal logical error was detected in the sort processing. Report this problem to Technical Support Services.

Mainframe External Sort Utilities and Message Options

By default, error messages created by a Mainframe external sort product are not displayed. However, you may wish to display these messages on your screen for diagnostic purposes.

Select a Sort Utility and Message Options

You use the SET SORTLIB command to both specify the sort utility used at your site and, for DFSORT and SYNC SORT on z/OS, to display sort messages.

Procedure

1. Issue the SET SORTLIB command to specify the sort utility being used:

```
SET SORTLIB = {sortutility|DEFAULT}
```

where:

sortutility

Can be one of the following:

- **DFSORT** for DFSORT without messages.
 - **MVSMGDF** for DFSORT with messages.
 - **SYNC SORT** for SyncSort without messages.
 - **MVMSGSS** for SyncSort with standard messages.
 - **MVMSGSD** for SyncSort with debug (verbose) messages.
 - **DEFAULT** for DFSORT. However, it is more efficient and highly recommended that you explicitly specify the sort utility using one of the other values.
2. If you specified a sort option that produces sort messages on z/OS, you must direct the sort messages to the batch output stream, a file, or the terminal.
Allocate DDNAME SYSOUT to the batch output stream or a file on z/OS by inserting

the appropriate following DD card into your FOCUS batch JCL, if it is not already there. For example, the following DD card allocates DDNAME SYSOUT to the batch output stream:

```
//SYSOUT DD SYSOUT=*
```

Online, the following ALLOCATE command allocates DDNAME SYSOUT to the terminal:

```
ALLOC F(SYSOUT) DA(*) REU
```

Diagnosing External Sort Errors

When an external sort generates an error, you can generate a trace of sort processing and examine the FOCUS return codes and messages to diagnose the problem.

Trace Sort Processing

When an external sort problem occurs, one of the following messages is generated:

```
(FOC909) CRITICAL ERROR IN EXTERNAL SORT. RETURN CODE IS: xxxx
(FOC1810) External sort not found
(FOC1899) Load of %1 (external-sort module) under %2 failed
```

In response to these messages, as well as for any other problem with sorting, it is useful to trace sort processing. For more information on diagnosing external sort problems, see [Diagnosing External Sort Errors](#).

Procedure

1. Allocate DDNAME FSTRACE to the terminal or a file. The following example sends trace output to the terminal:

```
//FSTRACE DD SYSOUT=*,DCB=(RECFM=FA,LRECL=133,BLKSIZE=133)
```

2. Activate the trace by adding the following commands in any supported profile or a

FOCEXEC:

```
SET TRACEUSER = ON
SET TRACEON = SORT/1/FSTRACE
```

External Sort Messages and Return Codes

When you receive a FOC909 message, it includes a return code:

```
(FOC909) CRITICAL ERROR IN EXTERNAL SORT. RETURN CODE IS: xxxx
```

You may also receive one of the following messages:

```
(FOC1810) External sort not found
(FOC1899) Load of %1 (external-sort module) under %2 failed
```

The following notes apply when this message or a FOC1800 or FOC1899 message is generated by a TABLE request:

- The most common value for xxxx is 16. However, return code 16 is issued for a number of problems, including but not limited to the following:
 - Syntax errors.
 - Memory shortage.
 - I/O errors (depending on installation options).
 - Space problems with output.
 - Space problems with work files.

In order to diagnose the error, you must generate external sort messages (using the instructions in [Select a Sort Utility and Message Options](#) and [Trace Sort Processing](#)) and then reproduce the failure.

For return codes not described below, follow the same procedure described for return code 16.

- Return code 20 is issued by DFSORT under z/OS if messages were requested (using the MVSMSGDJ option of the SET SORTLIB command), but the SYSOUT DD card is missing. DFSORT terminates after issuing the return code. Under the same

conditions, SyncSort attempts to open SYSOUT, producing the following message, and then continues with messages written to the operator or terminal:

```
IEC130I SYSOUT DD STATEMENT MISSING.
```

- Return code 36 or a FOC1899 message under z/OS means that the external sort module could not be found; check the STEPLIBs allocated.

When REBUILD INDEX invokes an external sort that fails, it generates a message similar to the following:

```
ERROR OCCURRED IN THE SORT yyyyyyyyzzzzzzzz
```

In this case, the return code is yyyyyyyy and it is expressed in hex. The final eight digits (zzzzzzzz) should be ignored.

Translate the return code into decimal and follow the instructions for return codes in a TABLE request.

Note also that when a TABLE request generates a non-zero return code from an external sort, FOCUS is terminated. By contrast, when REBUILD INDEX gets a non-zero return code from an external sort, the REBUILD command is terminated but FOCUS continues.

Responding to an Indication of Inadequate Sort Work Space

Before following these instructions, make sure that external sort messages were generated (for more information, see [Select a Sort Utility and Message Options](#)) and that they clearly show that the reason for failure was inadequate sort work space.

1. Make an estimate of the number of lines of output the request will produce.
2. Set the ESTLINES parameter in the request or FOCEXEC. For information, see [Provide an Estimate of Input Records or Report Size for Sorting](#).

FOCUS will pass this estimate to the external sort utility through the parameter list.

Do not override the DD cards for SORTWKnn, S001WKnn, DFSPARM, or \$SORTPARM without direct instructions from technical support. The instructions in [Select a Sort Utility and Message Options](#), [Trace Sort Processing](#), and [Providing an Estimate of](#)

[Input Records or Report Size for Sorting](#) should provide equivalent capabilities.

Aggregation by External Sort (Mainframe Environments Only)

External sorts can be used to perform aggregation with a significant decrease in processing time in comparison to using the internal sort facility. The gains are most notable with relatively simple requests against large data sources.

When aggregation is performed by an external sort, the statistical variables &RECORDS and &LINES are equal because the external sort products do not return a line count for the answer set. This is a behavior change, and affects any code that checks the value of &LINES. (If you must test &LINES, do not use this feature.)

Use Aggregation in Your External Sort

```
SET EXTAGGR = aggropt
```

where:

aggropt

Can be one of the following:

OFF disallows aggregation by an external sort.

NOFLOAT allows aggregation if there are no floating point data fields present.

ON allows aggregation by an external sort. This value is the default.

Usage Notes for Aggregating With an External Sort

- You must use SyncSort or DFSORT.

- Your query should be simple (that is, it should be able to take advantage of the TABLEF facility).
- The PRINT display command may not be used in the query.
- SET ALL must be equal to OFF.
- Only the following column prefixes are allowed: SUM, AVG, CNT, FST.
- Columns can be calculated values or have a row total.
- When SET EXTAGGR = NOFLOAT and your query aggregates numeric data, the external sort is not called, and aggregation is performed through the internal sorting procedure.

Changing Output by Using an External Sort for Aggregation

If you use SUM on an alphanumeric field in your report request without using an external sort, the last instance of the sorted fields is displayed in the output, by default. Turning on aggregation in the external sort displays the first record instead. However, you can control the order of display using the SUMPREFIX parameter. For information about the SUMPREFIX parameter, see [Improving Efficiency With External Sorts](#).

The following command turns aggregation ON and leaves SUMPREFIX set to LST (the default) and, therefore, displays the last record:

```
SET EXTAGGR = ON
SET SUMPREFIX = LST
TABLE FILE CAR
SUM CAR BY COUNTRY
END
```

The output is:

```
COUNTRY    CAR
-----    ---
ENGLAND    TRIUMPH
FRANCE     PEUGEOT
ITALY      MASERATI
```

JAPAN	TOYOTA
W GERMANY	BMW

i Note: SUMPREFIX is described in [Changing Retrieval Order With Aggregation \(Mainframe Environments Only\)](#).

With SUMPREFIX = FST, the output is:

COUNTRY	CAR
-----	---
ENGLAND	JAGUAR
FRANCE	PEUGEOT
ITALY	ALFA ROMEO
JAPAN	DATSUN
W GERMANY	AUDI

Changing Retrieval Order With Aggregation

The SUMPREFIX parameter allows you to specify which value will be displayed when aggregating an alphanumeric or smart date field in the absence of any prefix operator. The default value is LST, which will return the physical last value within the sort group. FST will return the first physical value in the sort group. MIN and MAX return either the minimum value or maximum value within the sort group.

The SUMPREFIX command allows users to choose the answer to set display order.

Set Retrieval Order

```
SET SUMPREFIX = {FST|LST|MIN|MAX}
```

where:

FST

Displays the first value when alphanumeric or smart date data types are aggregated.

LST

Displays the last value when alphanumeric or smart date data types are aggregated. LST is the default value.

MIN

Displays the minimum value in the sort order set by your FOCUS code page and configuration when alphanumeric or smart date data types are aggregated.

MAX

Displays the maximum value in the sort order set by your FOCUS code page and configuration when alphanumeric or smart date data types are aggregated.

Displaying the Minimum Value for an Aggregated Alphanumeric Field

The following request sets SUMPREFIX to MIN and displays the aggregated PRODUCT_CATEGORY and DAYSDELAYED values as well as the minimum, maximum, first, and last PRODUCT_CATEGORY values. In each row, the aggregated PRODUCT_CATEGORY value matches the MIN.PRODUCT_CATEGORY value. The DAYSDELAYED numeric field is not affected by the SUMPREFIX value and is aggregated.

```

SET SUMPREFIX = MIN
TABLE FILE WFLITE
SUM PRODUCT_CATEGORY DAYSDELAYED MIN.PRODUCT_CATEGORY MAX.PRODUCT_
CATEGORY
    FST.PRODUCT_CATEGORY LST.PRODUCT_CATEGORY
BY BRAND
WHERE BRAND GT 'K' AND BRAND LT 'U'
ON TABLE SET PAGE NOLEAD
ON TABLE SET STYLE *
GRID=OFF,$
ENDSTYLE
END

```

The output is shown in the following image.

<u>Brand</u>	<u>Product Category</u>	<u>Days Delayed</u>	<u>MIN Product Category</u>	<u>MAX Product Category</u>	<u>FST Product Category</u>	<u>LST Product Category</u>
LG	Media Player	339	Media Player	Televisions	Media Player	Televisions
Logitech	Accessories	114	Accessories	Accessories	Accessories	Accessories
Niles Audio	Accessories	150	Accessories	Accessories	Accessories	Accessories
Onkyo	Stereo Systems	140	Stereo Systems	Stereo Systems	Stereo Systems	Stereo Systems
Panasonic	Camcorder	422	Camcorder	Televisions	Camcorder	Televisions
Philips	Stereo Systems	229	Stereo Systems	Stereo Systems	Stereo Systems	Stereo Systems
Pioneer	Accessories	339	Accessories	Stereo Systems	Accessories	Stereo Systems
Polk Audio	Stereo Systems	93	Stereo Systems	Stereo Systems	Stereo Systems	Stereo Systems
Roku	Media Player	85	Media Player	Media Player	Media Player	Media Player
Samsung	Accessories	525	Accessories	Stereo Systems	Accessories	Stereo Systems
Sanyo	Camcorder	298	Camcorder	Stereo Systems	Camcorder	Stereo Systems
Sennheiser	Accessories	128	Accessories	Accessories	Accessories	Accessories
Sharp	Media Player	252	Media Player	Stereo Systems	Media Player	Stereo Systems
Sony	Accessories	1,100	Accessories	Televisions	Accessories	Televisions
Thomson Grass Valley	Video Production	166	Video Production	Video Production	Video Production	Video Production
Toshiba	Media Player	7	Media Player	Media Player	Media Player	Media Player

Creating a HOLD File With an External Sort

You can use Mainframe external sort packages to create HOLD files, producing substantial savings in processing time. The gains are most notable with relatively simple requests against large data sources.

Create HOLD Files With an External Sort

```
SET EXTHOLD = {OFF|ON}
```

where:

OFF

Disables HOLD files by an external sort.

ON

Enables HOLD files by an external sort. This value is the default.

Usage Notes for Creating a HOLD File With an External Sort

- The default setting of EXTSORT=ON must be in effect.
- EXTHOLD must be ON.
- The request must contain a BY field.
- The type of HOLD file created must be a FOCUS, XFOCUS, ALPHA, or BINARY file.
- Your query should be simple. AUTOTABLEF analyzes a query and determines whether the combination of display commands and formatting options requires the internal matrix. In cases where it is determined that a matrix is not necessary to satisfy the query, you may avoid the extra internal costs associated with creating the matrix. The internal matrix is stored in a file or data set named FOCSORT. The AUTOTABLEF default is ON, in order to realize performance gains.
- SET ALL must be OFF.
- There cannot be an IF/WHERE TOTAL or BY TOTAL in the request.
- If a request contains a SUM command, EXTAGGR must be set ON, and the only column prefixes allowed are SUM. and FST.

Hierarchical Reporting: BY HIERARCHY

Cube data sources such as Essbase or SAP BW are organized into dimensions and facts. Dimensions are often organized into hierarchies. The synonyms for cube data sources have attributes that describe the dimension hierarchies, and FOCUS has hierarchical reporting syntax that can automatically report against these hierarchies and display the results indented to show the hierarchical relationships.

FOCUS also supports defining dimension hierarchies in synonyms for non-cube data sources that have hierarchical data. Once hierarchical dimensions are defined in a synonym, you can issue hierarchical reporting requests against them. Non-cube synonyms with hierarchical attributes are called *virtual cubes*.

Dimensions are categories of data, such as Region or Time, that you use to analyze and compare business performance. Dimensions consist of data elements that are called members. For example, a Region dimension could have members England and France.

Dimension members are usually organized into hierarchies. Hierarchies can be viewed as tree-like structures where members are the nodes. For example, the Region dimension may have the element World at its top level (the root node). The World element may have children nodes (members) representing continents. Continents, in turn, can have children nodes that represent countries, and countries can have children nodes representing states or cities. Nodes with no children are called leaf nodes.

Measures are numeric values, such as Sales Volume or Net Income, that are used to quantify how your business is performing.

A cube consists of data derived from facts, which are records about individual business transactions. For example, an individual fact record reflects a sales transaction of a certain number of items of a certain product at a certain price, which occurred in a certain store at a certain moment in time. The cube contains summarized fact values for all combinations of measures and members of different dimensions.

A synonym describes a hierarchy using a set of fields that define the hierarchical structure and the relationships between the hierarchy members. FOCUS has special hierarchical reporting syntax for reporting on hierarchies.

Hierarchical reporting requests have several phases:

- **Phase 1, selecting hierarchy members to display.**

The hierarchical reporting phrase BY or ON HIERARCHY automatically sorts and formats a hierarchy with appropriate indentations that show the parent/child relationships. It also automatically rolls up the measure values for child members to generate the measure values for the parent members.

If you do not want to see the entire hierarchy, you can use the WHEN phrase to select hierarchy members for display. The expression in this WHEN phrase must reference only hierarchy fields, not dimension properties or measures.

- **Phase 2, screening the retrieved dimension data.**

WHERE criteria are applied to the leaf nodes of the members selected during phase 1. Therefore, dimension properties can be used in WHERE tests. These tests can also reference hierarchy fields. However, since the selection criteria are always applied to the values at the leaf nodes, they cannot select data based on values that occur at higher levels. For example, in a dimension with Continents, Countries, and Cities, your request will not display any rows if you use WHERE to select at the Country level, but it may if you use it to select at the City level. WHERE tests can also reference measures.

- **Phase 3, screening based on aggregated values.**

Measures, being summarized values, can be referenced in WHERE TOTAL tests and COMPUTE commands because those commands are processed after the hierarchy selection and aggregation phases of the request.

Specify a Hierarchy in a Master File

The data source must have at least one dimension that is organized hierarchically. The declaration for a dimension is:

```
DIMENSION=dimname,CAPTION=dimcaption, $
```

where:

dimname

Is a name for the dimension.

dimcaption

Is a label for the dimension.

The declaration for a hierarchy within the dimension is:

```
HIERARCHY=hname,CAPTION='hcaption',HRY_DIMENSION=dimname,  
HRY_STRUCTURE=RECURSIVE, $
```

where:

hname

Is a name for the hierarchy.

hcaption

Is a label for the hierarchy.

dimname

Is the name of the dimension for which this hierarchy is defined.

Several fields are used to define a parent/child hierarchy. Each has a PROPERTY attribute that describes which hierarchy property it represents. Each hierarchy must have a unique identifier field. This field is called the hierarchy field. If the synonym represents a FOCUS

data source, this field must be indexed (FIELDTYPE=I). The declaration for the hierarchy field is:

```
FIELD=hfield,ALIAS=halias,USAGE= An, [ACTUAL=Am,]
WITHIN='*hierarchy',PROPERTY=UID, [TITLE='title1',] [FIELDTYPE=I,] $
```

where:

hfield

Is the field name for the hierarchy field.

halias

Is the alias for the hierarchy field. If the data source is relational, this must be the name of the column in the Relational DBMS.

hierarchy

Is the name of the hierarchy to which this field belongs.

USAGE= An, [ACTUAL=Am,]

Are the USAGE format and, if the data source is not a FOCUS data source, the ACTUAL format of the field.

title1

Is an optional title for the field.

Other fields defined for the hierarchy include the parent field and the caption field. Each of these fields has the same name as the hierarchy field with a suffix added. Each has a PROPERTY attribute that specifies its role in the hierarchy and a REFERENCE attribute that points to the corresponding hierarchy field.

The following is the declaration for the parent field. The parent field is needed to define the parent/child relationships in the hierarchy:

```
FIELD=hfield_PARENT,ALIAS=parentalias,USAGE=An, [ACTUAL=Am,]
[TITLE=ptitle,]
PROPERTY=PARENT_OF, REFERENCE=hfield, $
```

where:

hfield

Is the hierarchy field.

parentalias

Is the alias for the parent field. If the data source is relational, this must be the name of the column in the relational DBMS.

USAGE= An, [ACTUAL=Am,]

Are the USAGE format and, if the data source is not a FOCUS data source, the ACTUAL format of the field.

ptitle

Is a column title for the parent field.

The following is the declaration for the caption field. A caption is a descriptive title for each value of the hierarchy field. It is part of the data and, therefore, is different from a TITLE attribute in the Master File, which is a literal title for the column on the report output.

```
FIELD=hfield_CAPTION,ALIAS=capalias,USAGE=Ann,[ACTUAL=Amm,]
[TITLE=captitle,]
PROPERTY=CAPTION, REFERENCE=hfield, $
```

where:

hfield

Is the hierarchy field.

capalias

Is the alias for the caption field. If the data source is relational, this must be the name of the column in the relational DBMS.

USAGE= Ann, [ACTUAL=Amm,]

Are the USAGE format and, if the data source is not a FOCUS data source, the ACTUAL format of the field.

captitle

Is a column title for the caption field.

Sample Master File With a Dimension Hierarchy

The following Master File is based on the CENTGL Master File, which has an FML hierarchy defined. This version is named NEWGL and it has a dimension hierarchy of accounts in which GL_ACCOUNT is the hierarchy field, GL_ACCOUNT_PARENT is the parent field, and GL_ACCOUNT_CAPTION is the caption field. There are other fields based on the hierarchy (GL_ACCOUNT_LEVEL, GL_ROLLUP_OP, and GL_ACCOUNT_TYPE). In addition, there is a measure field (GL_ACCOUNT_AMOUNT):

```
FILE=NEWGL      ,SUFFIX=FOC,$
SEGNAME=ACCOUNTS ,SEGTYPE=S01
DIMENSION=Accnt,CAPTION=Accnt, $
HIERARCHY=Accnt,CAPTION='Accnt',HRY_DIMENSION=Accnt,
HRY_STRUCTURE=RECURSIVE, $
FIELD=GL_ACCOUNT,GLACCT,A7,WITHIN='*Accnt',PROPERTY=UID,
      TITLE='Ledger,Account', FIELDTYPE=I, $
FIELD=GL_ACCOUNT_PARENT,GLPAR,A7, TITLE=Parent,
      PROPERTY=PARENT_OF, REFERENCE=GL_ACCOUNT, $
FIELD=GL_ACCOUNT_TYPE,GLTYPE,A1, TITLE=Type,$
FIELD=GL_ROLLUP_OP,ROLL,A1, TITLE=Op, $
FIELD=GL_ACCOUNT_LEVEL,GLLEVEL,I3, TITLE=Lev, $
FIELDNAME=GL_ACCOUNT_AMOUNT,GLAMT,D12.2, TITLE=Amount, $
FIELD=GL_ACCOUNT_CAPTION,GLCAP,A30, TITLE=Caption,
      PROPERTY=CAPTION, REFERENCE=GL_ACCOUNT, $
FIELD=SYS_ACCOUNT,ALINE,A6, TITLE='System,Account,Line', MISSING=ON, $
```

The following procedure loads data into this data source, as long as the Master File is available to FOCUS (on the path or allocated):

```
CREATE FILE NEWGL NOMSG
-RUN
MODIFY FILE NEWGL
COMPUTE TGL_ACCOUNT_LEVEL/A3=;
COMPUTE TGL_ACCOUNT_AMOUNT/A12=;
FIXFORM GL_ACCOUNT/A4B X3 GL_ACCOUNT_PARENT/A4B X3 GL_ACCOUNT_TYPE/A1B
FIXFORM SYS_ACCOUNT/A4B GL_ROLLUP_OP/A1B
FIXFORM TGL_ACCOUNT_LEVEL/A3B GL_ACCOUNT_CAPTION/A30B
FIXFORM TGL_ACCOUNT_AMOUNT/A12B
COMPUTE GL_ACCOUNT_LEVEL = EDIT(TGL_ACCOUNT_LEVEL);
COMPUTE GL_ACCOUNT_AMOUNT = ATODBL(TGL_ACCOUNT_AMOUNT , '12', GL_
ACCOUNT_AMOUNT);
```

MATCH GL_ACCOUNT
 ON MATCH REJECT
 ON NOMATCH INCLUDE

DATA

1000		R.	+	1Profit Before Tax	
2000	1000	R.	+	2Gross Margin	
2100	2000	R.	+	3Sales Revenue	
2200	2100	R.	+	4Retail Sales	
2210	2200	R7001+		5Retail - Television	505.00
2220	2200	R7002+		5Retail - Stereo	505.00
2230	2200	R7003+		5Retail - Video Player	505.00
2240	2200	R7004+		5Retail - Computer	505.00
2250	2200	R7005+		5Retail - Video Camera	505.00
2300	2100	R.	+	4Mail Order Sales	
2310	2300	R7011+		5Mail Order - Television	505.00
2320	2300	R7012+		5Mail Order - Stereo	505.00
2330	2300	R7013+		5Mail Order - Video Player	505.00
2340	2300	R7014+		5Mail Order - Computer	505.00
2350	2300	R7015+		5Mail Order - Video Camera	505.00
2400	2100	R.	+	4Internet Sales	
2410	2400	R7021+		5Internet - Television	505.00
2420	2400	R7022+		5Internet - Stereo	505.00
2430	2400	R7023+		5Internet - Video Player	505.00
2440	2400	R7024+		5Internet - Computer	505.00
2450	2400	R7025+		5Internet - Video Camera	505.00
2500	2000	E.	-	3Cost Of Goods Sold	
2600	2500	E.	+	4Variable Material Costs	
2610	2600	E7101+		5Television COGS	505.00
2620	2600	E7102+		5Stereo COGS	505.00
2630	2600	E7103+		5Video COGS	505.00
2640	2600	E7104+		5Computer COGS	505.00
2650	2600	E7105+		5Video Camera COGS	505.00
2700	2500	E7111+		4Direct Labor	404.00
2800	2500	E7112+		4Fixed Costs	404.00
3000	1000	E.	-	2Total Operating Expenses	
3100	3000	E.	+	3Selling Expenses	
3110	3100	E.	+	4Advertising	
3112	3110	E7202+		5TV/Radio	505.00
3114	3110	E7203+		5Print Media	505.00
3116	3110	E7206+		5Internet Advertising	505.00
3120	3100	E7212+		4Promotional Expenses	404.00
3130	3100	E7213+		4Joint Marketing	404.00
3140	3100	E7214+		4Bonuses/Commisions	404.00
3200	3000	E.	+	3General + Admin Expenses	
3300	3200	E.	+	4Salaries-Corporate	

3310	3300	E7301+	5Salaries-Corp Mgmt	505.00
3320	3300	E7302+	5Salaries-Administration	505.00
3330	3300	E7303+	5IT Contractors	505.00
3400	3200	E. +	4Company Benefits	
3410	3400	E7311+	5Social Security	505.00
3420	3400	E7312+	5Unemployment	505.00
3430	3400	E7313+	5Vacation Pay	505.00
3440	3400	E7314+	5Sick Pay	505.00
3450	3400	E. +	5Insurances	
3451	3450	E7321+	6Medical Insurance	606.00
3452	3450	E7322+	6Dental Insurance	606.00
3453	3450	E7323+	6Pharmacy Insurance	606.00
3454	3450	E7324+	6Disability Insurance	606.00
3455	3450	E7325+	6Life Insurance	606.00
3500	3200	E. +	4Depreciation Expenses	
3510	3500	E7411+	5Equipment	505.00
3520	3500	E7412+	5Building	505.00
3530	3500	E7413+	5Vehicles	505.00
3600	3200	R7414-	4Gain/(Loss) Sale of Equipment	404.00
3700	3200	E. +	4Leasehold Expenses	
3710	3700	E7421+	5Equipment	505.00
3720	3700	E7422+	5Buildings	505.00
3730	3700	R7429-	5Sub-Lease Income	505.00
3800	3200	E7440+	4Interest Expenses	404.00
3900	3200	E. +	4Utilities	
3910	3900	E7451+	5Electric	505.00
3920	3900	E7452+	5Gas	505.00
3930	3900	E7453+	5Telephone	505.00
3940	3900	E7454+	5Water	505.00
3950	3900	E7455+	5Internet Access	505.00
5000	1000	E. -	2Total R+D Costs	
5100	5000	E7511+	3Salaries	303.00
5200	5000	E7521+	3Misc. Equipment	303.00
END				

Report on a Hierarchy

In hierarchical reporting, measure values for child dimension members will be rolled up to generate the parent values. In the data source, the parent members should not have values for the measures.

```
SUM measure_field ...
BY hierarchy_field [HIERARCHY [WHEN expression_using_hierarchy_fields;]
[SHOW [TOP|UP n] [TO {BOTTOM|DOWN m}] [byoption [WHEN condition] ...] ]
[WHERE expression_using_dimension_data]
[ON hierarchy_field HIERARCHY [WHEN expression_using_hierarchy_fields;]
[SHOW [TOP|UP n] [TO BOTTOM|DOWN m] [byoption [WHEN condition] ...]]]
```

where:

measure_field

Is the field name of a measure.

BY hierarchy_field HIERARCHY

Identifies the hierarchy used for sorting. The field must be a hierarchy field.

ON hierarchy_field HIERARCHY

Identifies the hierarchy used for sorting. The field must be a hierarchy field. The request must include either a BY phrase or a BY HIERARCHY phrase for this field name.

WHEN expression_using_hierarchy_fields;

Selects hierarchy members. The WHEN phrase must immediately follow the word HIERARCHY to distinguish it from a WHEN phrase associated with a BY option (such as SUBFOOT). Any expression using only hierarchy fields is supported. The WHEN phrase can be on the BY HIERARCHY command or the ON HIERARCHY command, but not both.

SHOW

Specifies which levels to show on the report output relative to the levels selected by the WHEN phrase. If there is no WHEN phrase, the SHOW option is applied to the root node of the hierarchy. The SHOW option can be specified on the BY HIERARCHY phrase or the ON HIERARCHY phrase, but not both.

n

Is the number of ascendants above the set of selected members that will have measure values. All ascendants appear on the report to show the hierarchical context of the selected members. However, ascendants that are not included in the SHOW phrase appear on the report with missing data symbols in the report columns that display measures. The default for n is 0.

TOP

Specifies that ascendant levels to the root node of the hierarchy will be populated with measure values.

TO

Is required when specifying a SHOW option for descendant levels.

BOTTOM

Specifies all descendants to the leaf nodes of the hierarchy will be populated with measure values. This is the default value.

m

Is the number of descendants of each selected level that will display. The default for *m* is BOTTOM, which displays all descendants.

byoption

Is one of the following sort-based options: PAGE-BREAK, REPAGE, RECAP, RECOMPUTE, SKIP-LINE, SUBFOOT, SUBHEAD, SUBTOTAL, SUB-TOTAL, SUMMARIZE, UNDER-LINE. If you specify SUBHEAD or SUBFOOT, you must place the WHEN phrase on the line following the heading or footing text.

condition

Is a logical expression.

expression_using_dimension_data

Screens the rows selected in the BY/ON HIERARCHY and WHEN phrases based on dimension data. The expression can use dimension properties and hierarchy fields. However, the selection criteria are always applied to the values at the leaf nodes. Therefore, you cannot use WHERE to select rows based on hierarchy field values that occur at higher levels. For example, in a dimension with Continents, Countries, and Cities, your request will not display any rows if you use WHERE to select a Country name, but it may if you use it to select a City name.

Reporting on a Dimension Hierarchy

The following request reports on the entire GL_ACCOUNT hierarchy for the CENTGL2 data source created in the *ibi™ FOCUS® Describing Data* manual.

```
TABLE FILE NEWGL  
SUM GL_ACCOUNT_AMOUNT  
BY GL_ACCOUNT_HIERARCHY  
ON TABLE SET PAGE NOPAGE  
ON TABLE SET STYLE *  
TYPE=REPORT,GRID=OFF,$  
ENDSTYLE  
END
```

Partial output is shown in the following image. The accounts are indented to show the hierarchical relationships:

Ledger	
<u>Account</u>	<u>Amount</u>
1000	27,169.00
2000	10,908.00
2100	7,575.00
2200	2,525.00
2210	505.00
2220	505.00
2230	505.00
2240	505.00
2250	505.00
2300	2,525.00
2310	505.00
2320	505.00
2330	505.00
2340	505.00
2350	505.00
2400	2,525.00
2410	505.00
2420	505.00
2430	505.00
2440	505.00
2450	505.00
2500	3,333.00
2600	2,525.00
2610	505.00
2620	505.00
2630	505.00
2640	505.00
2650	505.00

The following is the same request using the GL_ACCOUNT_CAPTION field:

```
TABLE FILE NEWGL
SUM GL_ACCOUNT_AMOUNT
BY GL_ACCOUNT_CAPTION HIERARCHY
ON TABLE SET PAGE NOPAGE
ON TABLE SET STYLE *
TYPE=REPORT,GRID=OFF,$
ENDSTYLE
END
```

Partial output is shown in the following image:

<u>Caption</u>	<u>Amount</u>
Profit Before Tax	27,169.00
Gross Margin	10,908.00
Sales Revenue	7,575.00
Retail Sales	2,525.00
Retail - Television	505.00
Retail - Stereo	505.00
Retail - Video Player	505.00
Retail - Computer	505.00
Retail - Video Camera	505.00
Mail Order Sales	2,525.00
Mail Order - Television	505.00
Mail Order - Stereo	505.00
Mail Order - Video Player	505.00
Mail Order - Computer	505.00
Mail Order - Video Camera	505.00
Internet Sales	2,525.00
Internet - Television	505.00
Internet - Stereo	505.00
Internet - Video Player	505.00
Internet - Computer	505.00
Internet - Video Camera	505.00
Cost Of Goods Sold	3,333.00
Variable Material Costs	2,525.00
Television COGS	505.00
Stereo COGS	505.00
Video COGS	505.00
Computer COGS	505.00
Video Camera COGS	505.00

Using WHEN to Select Hierarchy Members

The following request selects certain accounts using the WHEN phrase and populates one level up and one level down from the selected nodes with values. Note that all levels to the root node display on the output for context, but if they are not in the members selected, they are not populated with measure values:

```
TABLE FILE NEWGL
SUM GL_ACCOUNT_AMOUNT
BY GL_ACCOUNT_CAPTION HIERARCHY
WHEN GL_ACCOUNT GT '2000' AND GL_ACCOUNT LT '3000';
  SHOW UP 1 TO DOWN 1
ON TABLE SET PAGE NOPAGE
ON TABLE SET STYLE *
TYPE=REPORT,GRID=OFF,$
ENDSTYLE
END
```

The output is shown in the following image:

<u>Caption</u>	<u>Amount</u>
Profit Before Tax	.
Gross Margin	10,908.00
Sales Revenue	7,575.00
Retail Sales	2,525.00
Retail - Television	505.00
Retail - Stereo	505.00
Retail - Video Player	505.00
Retail - Computer	505.00
Retail - Video Camera	505.00
Mail Order Sales	2,525.00
Mail Order - Television	505.00
Mail Order - Stereo	505.00
Mail Order - Video Player	505.00
Mail Order - Computer	505.00
Mail Order - Video Camera	505.00
Internet Sales	2,525.00
Internet - Television	505.00
Internet - Stereo	505.00
Internet - Video Player	505.00
Internet - Computer	505.00
Internet - Video Camera	505.00
Cost Of Goods Sold	3,333.00
Variable Material Costs	2,525.00
Television COGS	505.00
Stereo COGS	505.00
Video COGS	505.00
Computer COGS	505.00
Video Camera COGS	505.00
Direct Labor	404.00
Fixed Costs	404.00

Using WHERE to Screen Selected Hierarchy Members

The following request selects members using the WHEN phrase and then screens the output by applying a WHERE phrase to the selected members:

```
TABLE FILE NEWGL
SUM GL_ACCOUNT_AMOUNT GL_ACCOUNT_TYPE
BY GL_ACCOUNT HIERARCHY
WHEN GL_ACCOUNT NE '3000';
  SHOW UP 0 TO DOWN 0
WHERE GL_ACCOUNT_TYPE NE 'E' ;
ON TABLE SET PAGE NOLEAD
ON TABLE SET STYLE *
TYPE=REPORT, GRID=OFF,$
ENDSTYLE
END
```

The output is shown in the following image:

Ledger		
<u>Account</u>	<u>Amount</u>	<u>Type</u>
1000	8,484.00	R
2000	7,575.00	R
2100	7,575.00	R
2200	2,525.00	R
2210	505.00	R
2220	505.00	R
2230	505.00	R
2240	505.00	R
2250	505.00	R
2300	2,525.00	R
2310	505.00	R
2320	505.00	R
2330	505.00	R
2340	505.00	R
2350	505.00	R
2400	2,525.00	R
2410	505.00	R
2420	505.00	R
2430	505.00	R
2440	505.00	R
2450	505.00	R
3000	..	
3200	909.00	R
3600	404.00	R
3700	505.00	R
3730	505.00	R

Selecting Records for Your Report

When generating a report and selecting fields, you may not want to include every instance of a field. By including selection criteria, you can display only those field values that meet your needs. In effect, you can select a subset of data that you can easily redefine each time you issue the report request.

Selecting Records Overview

When developing a report request, you can define criteria that select records based on a variety of factors:

- The values of an individual field. See [Selections Based on Individual Values](#).
- The aggregate value of a field (for example, the sum or average of field values). See [Selection Based on Aggregate Values](#).
- The existence of missing values for a field, whether field values fall within a range, or whether a field does not contain a certain value. See [Types of Record Selection Tests](#).
- The number of records that exist for a field (for example, the first 50 records), rather than on the field values. See [Setting Limits on the Number of Records Read](#).
- For non-FOCUS data sources that have group keys, you can select records based on group key values. See [Selections Based on Group Key Values](#).

In addition, you can take advantage of a variety of record selection efficiencies, including assigning filtering criteria to a data source and reading selection values from a file.

Choosing a Filtering Method

There are two phrases for selecting records: WHERE and IF. It is recommended that you use WHERE to select records. IF offers a subset of the functionality of WHERE. Everything that you can accomplish with IF, you can also accomplish with WHERE. WHERE can accomplish things that IF cannot.

If you used IF to select records in the past, remember that WHERE and IF are two different phrases, and may require different syntax to achieve the same result.

WHERE syntax is described and illustrated throughout this topic. For details on IF syntax, see [Selecting Records Using IF Phrases](#).

Selections Based on Individual Values

The WHERE phrase selects records from the data source to be included in a report. The data is evaluated according to the selection criteria before it is retrieved from the data source.

You can use as many WHERE phrases as necessary to define your selection criteria. For an illustration, see [Using Multiple WHERE Phrases](#). For additional information, see [Using Compound Expressions for Record Selection](#).

i Note: Multiple selection tests on fields that reside on separate paths of a multi-path data source are processed as though connected by either AND or OR operators, based on the setting of a parameter called MULTIPATH. For details, see [Controlling Record Selection in Multi-path Data Sources](#).

Select Records With WHERE

```
WHERE criteria [;]
```

where:

criteria

Are the criteria for selecting records to include in the report. The criteria must be defined in a valid expression that evaluates as true or false (that is, a Boolean expression). Expressions are described in detail in [Using Expressions](#). Operators that can be used in WHERE expressions (such as, CONTAINS, IS, and GT), are described in [Operators Supported for WHERE and IF Tests](#).

;

Is an optional semicolon that can be used to enhance the readability of the request. It does not affect the report.

Usage Notes for WHERE Phrases

The WHERE phrase can include:

- Most expressions that would be valid on the right-hand side of a DEFINE expression. However, the logical expression IF ... THEN ... ELSE cannot be used.
- Real fields, temporary fields, and fields in joined files. If a field name is enclosed in single or double quotation marks, it is treated as a literal string, not a field reference.
- The operators EQ, NE, GE, GT, LT, LE, CONTAINS, OMITS, FROM ... TO, NOT-FROM ... TO, INCLUDES, EXCLUDES, LIKE, and NOT LIKE.
- All arithmetic operators (+, -, *, /, **), as well as, functions (MIN, MAX, ABS, and SQRT).
- An alphanumeric expression, which can be a literal, or a function yielding an alphanumeric or numeric result using EDIT or DECODE.

Note that files used with DECODE expressions can contain two columns, one for field values and one for numeric decode values.

- Alphanumeric and date literals enclosed in single quotation marks and date-time literals in the form DT (*date-time literal*).
- A date literal used in a selection test against a date field cannot contain the day of the week value.
- Text fields. However, the only operators supported for use with text fields are CONTAINS and OMITS.
- All functions.

You can build complex selection criteria by joining simple expressions with AND and OR logical operators and, optionally, adding parentheses to specify explicitly the order of evaluation. This is easier than trying to achieve the same effect with the IF phrase, which may require the use of a separate DEFINE command. For details, see [Using Compound Expressions for Record Selection](#).

Selecting Records for Partitioned FOCUS Data Sources

When you are reporting from a partitioned FOCUS data source, if your selection criteria are based on the same fields used to place data in the partitions, only those partitions with relevant data are opened for retrieval. For details on partitioned FOCUS data sources, see the *Describing Data* manual.

Using a Simple WHERE Test

To show only the names and salaries of employees earning more than \$20,000 a year, issue the following request:

```
TABLE FILE EMPLOYEE
PRINT LAST_NAME AND FIRST_NAME AND CURR_SAL
BY LAST_NAME NOPRINT
WHERE CURR_SAL GT 20000
END
```

In this example, CURR_SAL is a selected field, and CURR_SAL GT 20000 is the selection criterion. Only those records with a current salary greater than \$20,000 are retrieved; all other records are ignored.

The output is:

LAST_NAME	FIRST_NAME	CURR_SAL
-----	-----	-----
BANNING	JOHN	\$29,700.00
BLACKWOOD	ROSEMARIE	\$21,780.00
CROSS	BARBARA	\$27,062.00
IRVING	JOAN	\$26,862.00
ROMANS	ANTHONY	\$21,120.00

Using Multiple WHERE Phrases

You can use as many WHERE phrases as necessary to define your selection criteria. This request uses multiple WHERE phrases so that only those employees in the MIS or Production departments with the last name of Cross or Banning are included in the report.

```
TABLE FILE EMPLOYEE
PRINT EMP_ID LAST_NAME
WHERE SALARY GT 20000
WHERE DEPARTMENT IS 'MIS' OR 'PRODUCTION'
WHERE LAST_NAME IS 'CROSS' OR 'BANNING'
END
```

The output is:

EMP_ID	LAST_NAME
-----	-----
119329144	BANNING
818692173	CROSS

For related information, see [Using Compound Expressions for Record Selection](#).

Controlling Record Selection in Multi-path Data Sources

When you report from a multi-path data source, a parent segment may have children down some paths, but not others. The MULTIPATH parameter allows you to control whether such a parent segment is omitted from the report output.

The MULTIPATH setting also affects the processing of selection tests on independent paths. If MULTIPATH is set to:

- **COMPOUND**, WHERE or IF tests on separate paths are treated as if they are connected by an AND operator. That is, *all* paths must pass the screening tests in order for the parent to be included in the report output.
- **SIMPLE**, WHERE or IF tests on separate paths are considered independently, as if an OR operator connected them. Therefore, a parent instance is included in the report if at least one of the paths passes its screening test. A warning message is produced,

indicating that if the request contains a test on one path, data is also retrieved from another, independent path. Records on the independent path are retrieved regardless of whether the condition is satisfied on the tested path.

The MULTIPATH settings apply in all types of data sources and in all reporting environments (TABLE, TABLEF, MATCH, GRAPH, and requests with multiple display commands). MULTIPATH also works with alternate views, indexed views, filters, DBA, and joined structures.

Control Record Selection in Multi-path Data Sources

To set MULTIPATH from the command level or in a stored procedure, use

```
SET MULTIPATH = {SIMPLE | COMPOUND}
```

To set MULTIPATH in a report request, use

```
ON TABLE SET MULTIPATH {SIMPLE | COMPOUND}
```

where:

SIMPLE

Is the default value. Includes a parent segment in the report output if:

- It has at least one child that passes its screening conditions.



Note: A unique segment is considered a part of its parent segment, and therefore does not invoke independent path processing.

- It lacks any referenced child on a path, but the child is optional.

The (FOC144) warning message is generated when a request screens data in a multi-path report:

```
(FOC144) WARNING. TESTING IN INDEPENDENT SETS OF DATA
```

COMPOUND

Includes a parent in the report output if it has *all* of its required children. WHERE or IF tests on separate paths are treated as if they are connected by an AND operator. That is, *all* paths must pass the screening tests in order for the parent to be included in the report output.

For related information, see [MULTIPATH and SET ALL Combinations](#) and [Rules for Determining If a Segment Is Required](#).

Requirements and Usage Notes for MULTIPATH = COMPOUND

- The minimum memory requirement for the MULTIPATH = COMPOUND setting is 4K per active segment. If there is insufficient memory, the SIMPLE setting is implemented and a message is returned.

There is no limit to the number of segment instances (rows). However, no single segment instance can have more than 4K of active fields (referenced fields or fields needed for retrieving referenced fields). If this limit is exceeded, the SIMPLE setting is implemented and a message is returned.

- WHERE criteria that screen on more than one path with the OR operator are not supported.

Retrieving Data From Multiple Paths

This example uses the following segments from the EMPLOYEE data source:

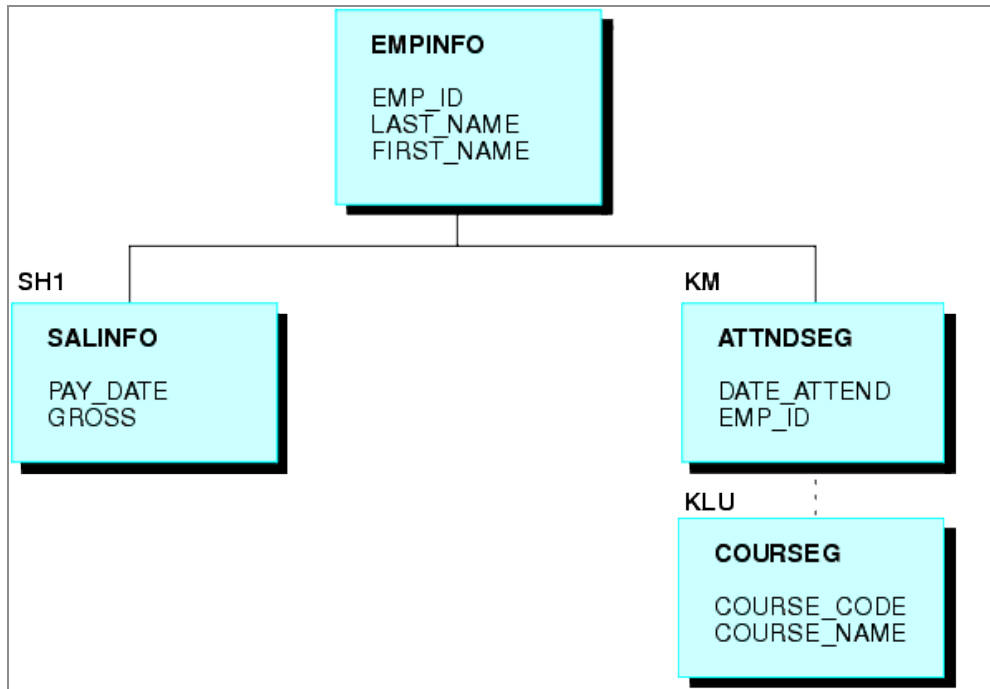

The request that follows retrieves data from both paths with MULTIPATH = SIMPLE, and displays data if either criterion is met:

```

SET ALL = OFF
SET MULTIPATH = SIMPLE
TABLE FILE EMPLOYEE
PRINT GROSS DATE_ATTEND COURSE_NAME
BY LAST_NAME BY FIRST_NAME
WHERE PAY_DATE EQ 820730
WHERE COURSE_CODE EQ '103'
END
  
```

The following warning message is generated:

```
(FOC144) WARNING. TESTING IN INDEPENDENT SETS OF DATA
```

Although several employees have not taken any courses, they are included in the report output since they have instances on one of the two paths.

The output is:

LAST_NAME	FIRST_NAME	GROSS	DATE_ATTEND	COURSE_NAME
-----	-----	-----	-----	-----

BLACKWOOD	ROSEMARIE	\$1,815.00	.	.
CROSS	BARBARA	\$2,255.00	.	.
GREENSPAN	MARY	\$750.00	.	.
IRVING	JOAN	\$2,238.50	.	.
JONES	DIANE	\$1,540.00	82/05/26	BASIC REPORT PREP FOR PROG
MCKNIGHT	ROGER	\$1,342.00	.	.
ROMANS	ANTHONY	\$1,760.00	.	.
SMITH	MARY	\$1,100.00	81/11/16	BASIC REPORT PREP FOR PROG
	RICHARD	\$791.67	.	.
STEVENS	ALFRED	\$916.67	.	.

LAST_NAME	FIRST_NAME	GROSS	DATE_ATTEND	COURSE_NAME
BANNING	JOHN	\$2,475.00	.	.
BLACKWOOD	ROSEMARIE	\$1,815.00	.	.
CROSS	BARBARA	\$2,255.00	.	.
GREENSPAN	MARY	\$750.00	.	.
IRVING	JOAN	\$2,238.50	.	.
JONES	DIANE	\$1,540.00	82/05/26	BASIC REPORT PREP FOR PROG
MCCOY	JOHN	\$1,540.00	.	.
MCKNIGHT	ROGER	\$1,342.00	.	.
ROMANS	ANTHONY	\$1,760.00	.	.
SMITH	MARY	\$1,100.00	81/11/16	BASIC REPORT PREP FOR PROG
	RICHARD	\$791.67	.	.
STEVENS	ALFRED	\$916.67	.	.

If you run the same request with MULTIPATH = COMPOUND, the employees without instances for COURSE_NAME are omitted from the report output, and the warning message is not generated.

The output is:

LAST_NAME	FIRST_NAME	GROSS	DATE_ATTEND	COURSE_NAME
-----	-----	-----	-----	-----
JONES	DIANE	\$1,540.00	82/05/26	BASIC REPORT
PREP FOR PROG				
SMITH	MARY	\$1,100.00	81/11/16	BASIC REPORT
PREP FOR PROG				

MULTIPATH and SET ALL Combinations

The ALL parameter affects independent path processing. The following table uses examples from the EMPLOYEE data source to explain the interaction of ALL and MULTIPATH.

Request	MULTIPATH=SIMPLE	MULTIPATH=COMPOUND
<pre>SET ALL = OFF PRINT EMP_ID PAY_DATE DATE_ ATTEND</pre>	Shows employees who have <i>either</i> SALINFO data <i>or</i> ATTNDSEG data.	Shows employees who have <i>both</i> SALINFO <i>and</i> ATTNDSEG data.
<pre>SET ALL = ON PRINT EMP_ID PAY_DATE DATE_ ATTEND</pre>	Shows employees who have SALINFO data <i>or</i> ATTNDSEG data <i>or</i> no child data at all.	Same as SIMPLE.
<pre>SET ALL = OFF PRINT EMP_ID PAY_DATE DATE_ ATTEND WHERE PAY_DATE EQ 980115</pre>	Shows employees who have <i>either</i> SALINFO data for 980115 <i>or</i> any ATTNDSEG data. Produces (FOC144) message.	Shows employees who have <i>both</i> SALINFO data for 980115 <i>and</i> ATTNDSEG data.
<pre>SET ALL = ON PRINT EMP_ID PAY_DATE DATE_ ATTEND WHERE PAY_DATE EQ 980115</pre>	Shows employees who have <i>either</i> SALINFO data for 980115 <i>or</i> any ATTNDSEG data. Produces (FOC144) message.	Shows employees who have SALINFO data for 980115. Any DATE_ATTEND data is also shown.
<pre>SET ALL = OFF PRINT ALL.EMP_ID DATE_ATTEND WHERE PAY_DATE EQ 980115</pre>	Shows employees who have <i>either</i> SALINFO data for 980115 <i>or</i> any ATTNDSEG data. Produces (FOC144) message.	Shows employees who have SALINFO data for 980115. Any DATE_ATTEND data is also shown.

Request	MULTIPATH=SIMPLE	MULTIPATH=COMPOUND
<pre>SET ALL = ON or OFF PRINT EMP_ID PAY_DATE DATE_ ATTEND WHERE PAY_DATE EQ 980115 AND COURSE_CODE EQ '103'</pre>	<p>Shows employees who have <i>either</i> SALINFO data for 980115 <i>or</i> COURSE 103.</p> <p>Note: SIMPLE treats AND in the WHERE clause as OR.</p> <p>Produces (FOC144) message.</p>	<p>Shows employees who have <i>both</i> SALINFO data for 980115 <i>and</i> COURSE 103.</p>

i Note: SET ALL = PASS is not supported with MULTIPATH = COMPOUND.

For related information about the ALL parameter, see [Handling Records With Missing Field Values](#).

Rules for Determining If a Segment Is Required

The segment rule is applied level by level, descending through the data source/view hierarchy. That is, a parent segment existence depends on the child segment existence, and the child segment depends on the grandchild existence, and so on, for the full data source tree.

The following rules are used to determine if a segment is required or optional:

- When SET ALL is ON or OFF, a segment with WHERE or IF criteria is required for its parent, and all segments up to the root segment are required for their parents.
When SET ALL = PASS, a segment with WHERE or IF criteria is optional.
- IF SET ALL = ON or PASS, all referenced segments with no WHERE or IF criteria are optional for their parents (outer join).
- IF SET ALL = OFF, all referenced segments are required (inner join).
- A referenced segment can become optional if its parent segment uses the ALL. field prefix operator.

i Note: ALL = PASS is not supported for all data adapters and, if it is supported, it may behave slightly differently. Check your specific data adapter documentation for detailed information.

For related information about the ALL parameter, see [Handling Records With Missing Field Values](#), and the *ibi™ FOCUS® Describing Data* manual.

Selection Based on Aggregate Values

You can select records based on the aggregate value of a field. For example, on the sum of field values, or on the average of field values, by using the WHERE TOTAL phrase. WHERE TOTAL is very helpful when you employ the aggregate display commands SUM and COUNT, and is required for fields with a prefix operator, such as AVE. and PCT.

In WHERE tests, data is evaluated before it is retrieved. In WHERE TOTAL tests, however, data is selected after all the data has been retrieved and processed. For an example, see [Using WHERE TOTAL for Record Selection](#).

Select Records With WHERE TOTAL

```
WHERE TOTAL criteria[;]
```

where:

criteria

Are the criteria for selecting records to include in the report. The criteria must be defined in a valid expression that evaluates as true or false (that is, a Boolean expression). Expressions are described in detail in [Using Expressions](#). Operators that can be used in WHERE expressions (such as, IS and GT) are described in [Operators Supported for WHERE and IF Tests](#).

;

Is an optional semicolon that can be used to enhance the readability of the request. It does not affect the report.

Usage Notes for WHERE TOTAL

- Any reference to a calculated value, or use of a feature that aggregates values, such as TOT.field, AVE.field, requires the use of WHERE TOTAL.
- Fields with prefix operators require the use of WHERE TOTAL.
- WHERE TOTAL tests are performed at the lowest sort level.
- Alphanumeric and date literals must be enclosed in single quotation marks. Date-time literals must be in the form DT (*date-time literal*).
- When you use ACROSS with WHERE TOTAL, data that does not satisfy the selection criteria is represented in the report with the NODATA character.
- If you save the output from your report request in a HOLD file, the WHERE TOTAL test creates a field called WH\$\$\$T1, which contains its internal computations. If there is more than one WHERE TOTAL test, each TOTAL test creates a corresponding WH\$\$\$T field and the fields are numbered consecutively.

Using WHERE TOTAL for Record Selection

The following example sums current salaries by department.

```
TABLE FILE EMPLOYEE
SUM CURR_SAL
BY DEPARTMENT
END
```

The output is:

DEPARTMENT	CURR_SAL
-----	-----
MIS	\$108,002.00
PRODUCTION	\$114,282.00

Now, add a WHERE TOTAL phrase to the request in order to generate a report that lists only the departments where the total of the salaries is more than \$110,000.

```
TABLE FILE EMPLOYEE
SUM CURR_SAL
BY DEPARTMENT
WHERE TOTAL CURR_SAL EXCEEDS 110000
END
```

The values for each department are calculated and then each final value is compared to \$110,000. The output is:

DEPARTMENT	CURR_SAL
-----	-----
PRODUCTION	\$114,282.00

Combining WHERE TOTAL and WHERE for Record Selection

The following request extracts records for the MIS department. Then, CURR_SAL is summed for each employee. If the total salary for an employee is greater than \$20,000, the values of CURR_SAL are processed for the report. In other words, WHERE TOTAL screens data after records are selected.

```
TABLE FILE EMPLOYEE
SUM CURR_SAL
BY LAST_NAME AND BY FIRST_NAME
WHERE TOTAL CURR_SAL EXCEEDS 20000
WHERE DEPARTMENT IS 'MIS'
END
```

The output is:

LAST_NAME	FIRST_NAME	CURR_SAL
-----	-----	-----
BLACKWOOD	ROSEMARIE	\$21,780.00
CROSS	BARBARA	\$27,062.00

Applying Selection Criteria to the Internal Matrix Prior to COMPUTE Processing

WHERE TOTAL tests are applied to the rows of the internal matrix after COMPUTE calculations are processed in the output phase of the report. WHERE_GROUPED tests are applied to the internal matrix values prior to COMPUTE calculations. The processing then continues with COMPUTE calculations, and then WHERE TOTAL tests. This allows the developer to control the evaluation, and is particularly useful in recursive calculations.

Apply WHERE_GROUPED Selection Criteria

```
WHERE_GROUPED expression
```

where:

expression

Is an expression that does not refer to more than one row in the internal matrix. For example, it cannot use the LAST operator to refer to or retrieve a value from a prior record.

Using a WHERE_GROUPED Test

The following request has two COMPUTE commands. The first COMPUTE checks to see if the business region value has changed, incrementing a counter if it has. This allows us to sequence the records in the matrix. The second COMPUTE creates a rolling total of the days delayed within the business region.

```
TABLE FILE WFLITE
SUM  DAYSDELAYED AS DAYS
COMPUTE CTR/I3 = IF BUSINESS_REGION EQ LAST BUSINESS_REGION THEN CTR+1
ELSE 1;
COMPUTE NEWDAYS = IF BUSINESS_REGION EQ LAST BUSINESS_REGION THEN
NEWDAYS+DAYSDELAYED ELSE DAYSDELAYED;
BY BUSINESS_REGION AS Region
BY TIME_MTH
```

```
WHERE BUSINESS_REGION NE 'Oceania'
ON TABLE SET PAGE NOPAGE
END
```

The output is shown in the following image.

Region	Sale Month	DAYS	CTR	NEWDAYS
EMEA	1	191	1.00	191.00
	2	205	2.00	396.00
	3	224	3.00	620.00
	4	213	4.00	833.00
	5	185	5.00	1,018.00
	6	234	6.00	1,252.00
	7	223	7.00	1,475.00
	8	234	8.00	1,709.00
	9	249	9.00	1,958.00
	10	290	10.00	2,248.00
	11	1	11.00	2,249.00
North America	1	253	1.00	253.00
	2	205	2.00	458.00
	3	293	3.00	751.00
	4	319	4.00	1,070.00
	5	273	5.00	1,343.00
	6	268	6.00	1,611.00
	7	219	7.00	1,830.00
	8	248	8.00	2,078.00
	9	220	9.00	2,298.00
	10	326	10.00	2,624.00
	11	8	11.00	2,632.00
South America	1	64	1.00	64.00
	2	87	2.00	151.00
	3	29	3.00	180.00
	4	39	4.00	219.00
	5	29	5.00	248.00
	6	49	6.00	297.00
	7	16	7.00	313.00
	8	26	8.00	339.00
	9	54	9.00	393.00
	10	54	10.00	447.00

The following version of the request adds a WHERE TOTAL test to select only those months where DAYSDELAYED exceeded 200 days.

```
TABLE FILE WFLITE
SUM  DAYSDELAYED AS DAYS
COMPUTE CTR/I3 = IF BUSINESS_REGION EQ LAST BUSINESS_REGION THEN CTR+1
ELSE 1;
COMPUTE NEWDAYS= IF BUSINESS_REGION EQ LAST BUSINESS_REGION THEN
NEWDAYS+DAYSDELAYED ELSE DAYSDELAYED;
BY BUSINESS_REGION AS Region
BY TIME_MTH
WHERE BUSINESS_REGION NE 'Oceania'
WHERE TOTAL DAYSDELAYED GT 200
ON TABLE SET PAGE NOPAGE
END
```

The output is shown in the following image. The COMPUTE calculations for CTR and NEWDAYS were processed prior to eliminating the rows in which TOTAL DAYSDELAYED were 200 or less, so their values are the same as in the original output. This does not correctly reflect the sequence of records and the rolling total of the values that are actually displayed on the output. To do this, we need to select the appropriate months (DAYSDELAYED GT 200) before the COMPUTE expressions are evaluated. This requires WHERE_GROUPED.

Region	Sale Month	DAYS	CTR	NEWDAYS
EMEA	2	205	2.00	396.00
	3	224	3.00	620.00
	4	213	4.00	833.00
	6	234	6.00	1,252.00
	7	223	7.00	1,475.00
	8	234	8.00	1,709.00
	9	249	9.00	1,958.00
	10	290	10.00	2,248.00
North America	1	253	1.00	253.00
	2	205	2.00	458.00
	3	293	3.00	751.00
	4	319	4.00	1,070.00
	5	273	5.00	1,343.00
	6	268	6.00	1,611.00
	7	219	7.00	1,830.00
	8	248	8.00	2,078.00
	9	220	9.00	2,298.00
	10	326	10.00	2,624.00

The following version of the request replaces the WHERE TOTAL test with a WHERE_GROUPED test.

```
TABLE FILE WFLITE
SUM  DAYSDELAYED AS DAYS
COMPUTE CTR/I3 = IF BUSINESS_REGION EQ LAST BUSINESS_REGION THEN CTR+1
ELSE 1;
COMPUTE NEWDAYS= IF BUSINESS_REGION EQ LAST BUSINESS_REGION THEN
NEWDAYS+DAYSDELAYED ELSE DAYSDELAYED;
BY BUSINESS_REGION AS Region
BY TIME_MTH
WHERE BUSINESS_REGION NE 'Oceania'
WHERE_GROUPED DAYSDELAYED GT 200
ON TABLE SET PAGE NOPAGE
END
```

The output is shown in the following image. The COMPUTE calculation for NEWDAYS was processed after eliminating the rows in which TOTAL DAYSDELAYED were 200 or less, so its values are based on fewer rows than the calculations in the original request. This is verified by the CTR values, which are now in a continuous sequence. The rolling total now reflects the values that are actually displayed on the report output.

Region	Sale Month	DAYS	CTR	NEWDAYS
EMEA	2	205	1.00	205.00
	3	224	2.00	429.00
	4	213	3.00	642.00
	6	234	4.00	876.00
	7	223	5.00	1,099.00
	8	234	6.00	1,333.00
	9	249	7.00	1,582.00
	10	290	8.00	1,872.00
North America	1	253	1.00	253.00
	2	205	2.00	458.00
	3	293	3.00	751.00
	4	319	4.00	1,070.00
	5	273	5.00	1,343.00
	6	268	6.00	1,611.00
	7	219	7.00	1,830.00
	8	248	8.00	2,078.00
	9	220	9.00	2,298.00
	10	326	10.00	2,624.00

Usage Notes for WHERE_GROUPED

- If the expression refers to multiple rows in the internal matrix, the following message is generated and processing stops.

(FOC32692) WHERE_GROUPED CANNOT REFER TO OTHER LINES OF REPORT

- A COMPUTE that does not reference multiple lines will be evaluated prior to WHERE_GROUPED tests, and may, therefore, be used in an expression and evaluated as part of a WHERE_GROUPED test.
- WHERE_GROUPED can be optimized for SQL data sources by creating a GROUP BY *fieldname* HAVING *expression* clause, where the expression is the WHERE_GROUPED selection criteria.

Using Compound Expressions for Record Selection

You can combine two or more simple WHERE expressions, connected by AND and/or OR operators, to create a compound expression.

By default, when multiple WHERE phrases are evaluated, logical ANDs are processed before logical ORs. In compound expressions, you can use parentheses to change the order of evaluation. All AND and OR operators enclosed in parentheses are evaluated first, followed by AND and OR operators outside of parentheses.

You should always use parentheses in complex expressions to ensure that the expression is evaluated correctly. For example:

```
WHERE (SEATS EQ 2) AND (SEATS NOT-FROM 3 TO 4)
```

This is especially useful when mixing literal OR tests with logical AND and OR tests:

- In a logical AND or OR test, all field names, test relations, and test values are explicitly referenced and connected by the words OR or AND. For example:

```
WHERE (LAST_NAME EQ 'CROSS') OR (LAST_NAME EQ 'JONES')
```

or

```
WHERE (CURR_SAL GT 20000) AND (DEPARTMENT IS 'MIS')  
AND (CURR_JOBCODE CONTAINS 'A')
```

- In a literal OR test, the word OR is repeated between test values of a field name, but the field name itself and the connecting relational operator are not repeated. For example:

```
WHERE (LAST_NAME EQ 'CROSS' OR 'JONES')
```

Mixing AND and OR Record Selection Tests

This example illustrates the impact of parentheses on the evaluation of literal ORs and logical ANDs.

In this request, each expression enclosed in parentheses is evaluated first in the order in which it appears. Notice that the first expression contains a literal OR. The result of each expression is then evaluated using the logical AND.

If parentheses are excluded, the logical AND is evaluated before the literal OR.

```
TABLE FILE EMPLOYEE
PRINT CURR_SAL BY LAST_NAME
WHERE (LAST_NAME EQ 'CROSS' OR 'JONES')
AND (CURR_SAL GT 22000)
END
```

The output is:

```
LAST_NAME          CURR_SAL
-----
CROSS              $27,062.00
```

Using Operators in Record Selection Tests

You can include a variety of operators in your WHERE and IF selection tests. Many of the operators are common for WHERE and IF. However, several are supported only for WHERE tests.

Operators Supported for WHERE and IF Tests

You can define WHERE and IF selection criteria using the following operators.

WHERE Operator	IF Operator	Meaning
EQ IS	EQ IS	Tests for and selects values equal to the test expression.

WHERE Operator	IF Operator	Meaning
NE IS-NOT	NE IS-NOT	Tests for and selects values not equal to the test expression.
GE	GE FROM IS-FROM	Tests for and selects values greater than or equal to the test value (based on the characters 0 to 9 for numeric values, A to Z and a to z for alphanumeric values). The test value can be a field value or the result of an expression.
GT EXCEEDS IS-MORE-THAN	GT EXCEEDS IS-MORE-THAN	Tests for and selects values greater than the test value.
LT IS-LESS-THAN	LT IS-LESS-THAN	Tests for and selects values less than the test value.
LE	LE TO	Tests for and selects values less than or equal to the test value.
GE lower AND ... LE upper		Tests for and selects values within a range of values.
LT lower OR ... GT upper		Tests for and selects values outside of a range of values.
FROM lower		Tests for and selects values within a range of values.

WHERE Operator	IF Operator	Meaning
TO upper		
IS-FROM lower TO upper	IS-FROM lower TO upper	Tests for and selects values within a range of values. For WHERE, this is an alternate syntax for FROM lower to UPPER. Both operators produce identical results.
NOT-FROM lower TO upper	NOT-FROM lower TO upper	Tests for and selects values that are outside a range of values.
IS MISSING IS-NOT MISSING NE MISSING	IS MISSING IS-NOT MISSING NE MISSING	Tests whether a field contains missing values. If some instances of the field contain no data, they have missing data. For information on missing data, see Handling Records With Missing Field Values .
CONTAINS LIKE	CONTAINS LIKE	Tests for and selects values that include a character string matching test value. The string can occur in any position in the value being tested. When used with WHERE, CONTAINS can test alphanumeric fields. When used with IF, it can test both alphanumeric and text fields.
OMITS NOT LIKE	OMITS UNLIKE	Tests for and selects values that do not include a character string matching test value. The string cannot occur in any position in the value being tested. When used with WHERE, OMITS can test alphanumeric fields. When used with IF, it can test both alphanumeric and

WHERE Operator	IF Operator	Meaning
		text fields.
INCLUDES	INCLUDES	Tests whether a chain of values of a given field in a child segment includes all of a list of literals.
EXCLUDES	EXCLUDES	Tests whether a chain of values of a given field in a child segment excludes all of a list of literals.
IN (z,x,y)		Selects records based on values found in an unordered list.
NOT ... IN (z,x,y)		Selects records based on values not found in an unordered list.
IN FILE		Selects records based on values stored in a sequential file.
NOT ... IN FILE		Selects records with field values not found in a sequential file.
IF-THEN-ELSE		Selects records based on the logical conditions listed in the IF-THEN-ELSE phrase.

Using Operators to Compare a Field to One or More Values

The following examples illustrate field selection criteria that use one or more values. You may use the operators: EQ, IS, IS-NOT, EXCEEDS, IS-LESS-THAN, and IN.

Example 1: The field LAST_NAME must equal the value JONES:

```
WHERE LAST_NAME EQ 'JONES'
```

Example 2: The field LAST_NAME begins with 'CR' or 'MC:'

```
WHERE EDIT (LAST_NAME, '99') EQ 'CR' OR 'MC'
```

Example 3: The field AREA must not equal the value EAST or WEST:

```
WHERE AREA IS-NOT 'EAST' OR 'WEST'
```

Example 4: The value of the field AREA must equal the value of the field REGION:

```
WHERE AREA EQ REGION
```

Note that you cannot compare one field to another in an IF test.

Example 5: The ratio between retail cost and dealer cost must be greater than 1.25:

```
WHERE RETAIL_COST/DEALER_COST GT 1.25
```

Example 6: The field UNITS must be equal to or less than the value 50, and AREA must not be equal to either NORTH EAST or WEST. Note the use of single quotation marks around NORTH EAST. All alphanumeric strings must be enclosed within single quotation marks.

```
WHERE UNITS LE 50 WHERE AREA IS-NOT 'NORTH EAST' OR 'WEST'
```

Example 7: The value of AMOUNT must be greater than 40:

```
WHERE AMOUNT EXCEEDS 40
```

Example 8: The value of AMOUNT must be less than 50:

```
WHERE AMOUNT IS-LESS-THAN 50
```

Example 9: The value of SALES must be equal to one of the numeric values in the unordered list. Use commas or blanks to separate the list values.

```
WHERE SALES IN (43000,12000,13000)
```

Example 10: The value of CAR must be equal to one of the alphanumeric values in the unordered list. Single quotation marks must enclose alphanumeric list values.

```
WHERE CAR IN ('JENSEN', 'JAGUAR')
```

Using IF-THEN-ELSE Logic in a WHERE Clause

The following request uses IF-THEN-ELSE logic in a WHERE clause to select records based on values of WHOLESALEPR where the values used for selection vary depending on the value of LISTPR in that record.

```
TABLE FILE MOVIES  
PRINT COPIES  
LISTPR  
WHOLESALEPR  
BY CATEGORY  
WHERE WHOLESALEPR GT (IF LISTPR GT 20.00 THEN 15.00 ELSE 11.00)  
ON TABLE SET PAGE NOLEAD  
ON TABLE SET STYLE *  
GRID=OFF,$  
ENDSTYLE  
END
```

The output is shown in the following image. In the selected records, WHOLESALEPR is greater than \$15.00 if LISTPR is greater than \$20.00. WHOLESALEPR is greater than \$11.00 if LISTPR is less than or equal to \$20.00.

<u>CATEGORY</u>	<u>COPIES</u>	<u>LISTPR</u>	<u>WHOLESALEPR</u>
ACTION	3	19.98	11.50
	4	19.99	11.99
CHILDREN	2	44.95	29.99
	1	29.95	15.99
CLASSIC	3	39.99	20.00
	1	29.95	15.99
	3	89.95	40.99
COMEDY	2	89.99	40.99
	4	19.95	12.55
	2	19.95	12.55
	3	59.99	30.00
	4	19.98	13.75
FOREIGN	4	19.98	13.75
	1	19.98	13.25
	1	59.95	30.00
	1	29.95	15.99
	1	39.98	25.00
	1	59.95	32.00
MUSICALS	1	59.95	30.00
	1	19.98	13.99
	1	19.98	13.99
MYSTERY	4	29.98	15.99
	2	25.99	15.99
	4	59.99	30.00
SCI/FI	1	19.98	14.99
	1	19.98	14.55
	1	19.95	13.99
	1	24.95	16.00
	3	29.98	19.99

Types of Record Selection Tests

You can select records for your reports using a variety of tests that are implemented using the operators described in [Operators Supported for WHERE and IF Tests](#). You can test for:

- Values that lie within or outside of a range. See [Types of Record Selection Tests](#) and [Range Tests With GE and LE or GT and LT](#).
- Missing or existing data. See [Missing Data Tests](#).
- The existence or absence of a character string. See [Character String Screening With](#)

CONTAINS and OMITs.

- Partially defined character strings in a data field. See [Types of Record Selection Tests](#).
- Literals in a parent segment. See [Qualifying Parent Segments Using INCLUDES and EXCLUDES](#).

Range Tests With FROM and TO

Use the operators FROM ... TO and NOT-FROM ... TO in order to determine whether field values fall within or outside of a given range. You can use either values or expressions to specify the lower and upper boundaries. Range tests can also be applied on the sort control fields. The range test is specified immediately after the sort phrase.

You can also test whether an expression falls within or outside the boundaries.

Specify a Range Test (FROM and TO)

```
WHERE [TOTAL] {fieldname|expression} {FROM|IS-FROM} lower TO upper
WHERE [TOTAL] fieldname NOT-FROM      lower TO upper
```

where:

fieldname

Is any valid field name or alias.

expression

Is any valid expression.

lower

Are numeric or alphanumeric values or expressions that indicate lower boundaries. You may add parentheses around expressions for readability.

upper

Are numeric or alphanumeric values or expressions that indicate upper boundaries. You may add parentheses around expressions for readability.

Range Test With FROM ... TO

An example of a range test using expressions as boundaries follows:

```
WHERE SALES FROM (DEALER_COST * 1.4) TO (DEALER_COST * 2.0)
```

The following is an example of a range test using expressions as the comparison value and the boundaries:

```
WHERE SALES * 1.5 FROM (DEALER_COST * 1.4) TO (DEALER_COST * 2.0)
```

Range Test With NOT-FROM ... TO

The following illustrates how you can use the range test NOT-FROM ... TO to display only those records that fall outside of the specified range. In this example, it is all employees whose salaries do not fall in the range between \$12,000 and \$22,000.

```
TABLE FILE EMPLOYEE
PRINT CURR_SAL
BY LAST_NAME
WHERE CURR_SAL NOT-FROM 12000 TO 22000
END
```

The output is:

LAST_NAME	CURR_SAL
-----	-----
BANNING	\$29,700.00
CROSS	\$27,062.00
GREENSPAN	\$9,000.00
IRVING	\$26,862.00
SMITH	\$9,500.00
STEVENS	\$11,000.00

Range Tests on Sort Fields With FROM ... TO

The following examples demonstrate how to perform range tests when sorting a field using the BY or ACROSS sort phrases:

```
BY MONTH FROM 4 TO 8
```

or

```
ACROSS MONTH FROM 6 TO 10
```

Range Tests With GE and LE or GT and LT

The operators GE (greater than or equal to), LE (less than or equal to), GT (greater than), and LT (less than) can be used to specify a range.

GE ... LE enable you to specify values within the range of test boundaries.

LT ...GT enable you to specify values outside the range test boundaries.

Specify Range Tests (GE and LE)

To select values that fall within a range, use

```
WHERE fieldname GE lower AND fieldname LE upper
```

To find records whose values do not fall in a specified range, use

```
WHERE fieldname LT lower OR fieldname GT upper
```

where:

fieldname

Is any valid field name or alias.

lower

Are numeric or alphanumeric values or expressions that indicate lower boundaries. You may add parentheses around expressions for readability.

upper

Are numeric or alphanumeric values or expressions that indicate upper boundaries. You may add parentheses around expressions for readability.

Selecting Values Inside a Range

This WHERE phrase selects records in which the UNIT value is between 10,000 and 14,000.

```
WHERE UNITS GE 10000 AND UNITS LE 14000
```

This example is equivalent to:

```
WHERE UNITS GE 10000
WHERE UNITS LE 14000
```

Selecting Values Outside a Range

The following illustrates how you can select values that are outside a range of values using the LT and GT operators. In this example, only those employees whose salaries are less than \$12,000 and greater than \$22,000 are included in the output.

```
TABLE FILE EMPLOYEE
PRINT CURR_SAL
BY LAST_NAME
WHERE CURR_SAL LT 12000 OR CURR_SAL GT 22000
END
```

The output is:

LAST_NAME	CURR_SAL
-----	-----
BANNING	\$29,700.00
CROSS	\$27,062.00
GREENSPAN	\$9,000.00
IRVING	\$26,862.00
SMITH	\$9,500.00
STEVENS	\$11,000.00

Missing Data Tests

When creating report requests, you may want to test for missing data. This type of test is most useful when fields that have missing data also have the MISSING attribute set to ON in the Master File. For information on missing data, see [Handling Records With Missing Field Values](#), and the *ibi™ FOCUS® Describing Data* manual.

i Note: If a test value to screen on an alphanumeric field is a variable and you want to look for missing instances, you must use `_FOC_MISSING`, instead of `MISSING`, as an alphanumeric literal value in a test must be in single quotation marks, and `'MISSING'` is the literal value `MISSING`, not the `MISSING` value. The value `_FOC_MISSING` represents the `MISSING` value whether it is in single quotation marks or not.

Test for Missing Data

```
{WHERE|IF} fieldname {EQ|IS} MISSING
```

where:

fieldname

Is any valid field name or alias.

EQ|IS

Are record selection operators. EQ and IS are synonyms.

Test for Existing Data

```
{WHERE|IF} fieldname {NE|IS-NOT} MISSING
```

where:

fieldname

Is any valid field name or alias.

NE|IS-NOT

Are record selection operators. NE and IS-NOT are synonyms.

Character String Screening With CONTAINS and OMITS

The CONTAINS and OMITS operators test alphanumeric fields when used with WHERE, and both alphanumeric and text fields when used with IF. With CONTAINS, if the characters in the given literal or literals appear anywhere within the characters of the field value, the test is passed.

OMITS is the opposite of CONTAINS; if the characters of the given literal or literals appear anywhere within the characters of the field's value, the test fails.

CONTAINS and OMITS tests are useful when you do not know the exact spelling of a value. As long as you know that a specific string appears within the value, you can retrieve the desired data.

Selecting Records With CONTAINS and OMITS

The following examples illustrate several ways to use the CONTAINS and OMITS operators. The field name that is being tested must appear on the left side of the CONTAINS or OMITS operator.

- In this example, the characters JOHN are contained in JOHNSON, and are selected by the following phrase:

```
WHERE LAST_NAME CONTAINS 'JOHN'
```

The LAST_NAME field may contain the characters JOHN anywhere in the field.

- In this example, any last name without the string JOHN is selected:

```
WHERE LAST_NAME OMITTS 'JOHN'
```

- In this example, all names that contain the letters ING are retrieved.

```
TABLE FILE EMPLOYEE
LIST LAST_NAME AND FIRST_NAME
WHERE LAST_NAME CONTAINS 'ING'
END
```

The output is:

LIST	LAST_NAME	FIRST_NAME
----	-----	-----
1	BANNING	JOHN
2	IRVING	JOAN

Screening on Masked Fields

A mask is an alphanumeric pattern that you supply for comparison to characters in a data field. The data field must have an alphanumeric format (A). You can use the LIKE and NOT LIKE or the IS and IS-NOT operators to perform screening on masked fields.

The wildcard characters for screening on masked fields with:

- LIKE and NOT LIKE operators are % and _. The percent allows any following sequence of zero or more characters. The underscore indicates that any character in that position is acceptable. The LIKE operator is supported in expressions that are used to derive temporary fields with either the DEFINE or COMPUTE command.
- IS (or EQ) and IS-NOT (or NE) operators are \$ and \$*. The dollar sign indicates that any character in that position is acceptable. The \$* is shorthand for writing a sequence of dollar signs to fill the end of the mask without specifying a length. This combination can only be used at the end of the mask.

In IF clauses and those WHERE clauses that can be translated into one or more IF clauses, you can treat the \$ and \$* characters as normal characters rather than wildcards by issuing the SET EQTEST=EXACT command.

i Note: The IS (or EQ) and IS-NOT (or NE) operators support screening based on a mask for fixed-length formats only. If the format is a variable length format, for example, A n V, use the LIKE or NOT LIKE operator to screen based on a mask.

Screen Fields Based on a Mask (Using LIKE and NOT LIKE)

To search for records with the LIKE operator, use

```
WHERE field LIKE 'mask'
```

To reject records based on the mask value, use either

```
WHERE field NOT LIKE 'mask'
```

or

```
WHERE NOT field LIKE 'mask'
```

where:

field

Is any valid field name or alias.

mask

Is an alphanumeric or text character string you supply. There are two wildcard characters that you can use in the mask. The underscore (_) indicates that any character in that position is acceptable, and the percent sign (%) allows any following sequence of zero or more characters.

For related information, see [Restrictions on Masking Characters](#).

Screen Using LIKE and UNLIKE in an IF Phrase

To search for records with the LIKE operator, use

```
IF field LIKE 'mask1' [OR 'mask2'...]
```

To reject records based on the mask value, use

```
IF field UNLIKE 'mask1' [OR 'mask2' ...]
```

where:

field

Is any valid field name or alias.

mask1, mask2

Are the alphanumeric patterns you want to use for comparison. The single quotation marks are required if the mask contains blanks. There are two wildcard characters that you can use in a mask. The underscore (_) indicates that any character in that position is acceptable, and the percent sign (%) allows any following sequence of zero or more characters. Every other character in the mask accepts only itself in that position as a match to the pattern.

Screen Fields Based on a Mask (Using IS and IS-NOT)

To search for records with the IS operator, use

```
{WHERE|IF} field {IS|EQ} 'mask'
```

To reject records based on the mask value, use

```
{WHERE|IF} field {IS-NOT|NE} 'mask'
```

where:

field

Is any valid field name or alias.

IS|IS-NOT

Are record selection operators. EQ is a synonym for IS. NE is a synonym for IS-NOT.

mask

Is an alphanumeric or text character string you supply. The wildcard characters that you can use in the mask are the dollar sign (\$) and the combination \$*. The dollar sign indicates that any character in that position is acceptable. The \$* combination allows any sequence of zero or more characters. The \$* is shorthand for writing a sequence of dollar signs to fill the end of the mask without specifying a specific length. This combination can only be used at the end of the mask.

For related information, see [Restrictions on Masking Characters](#).

Restrictions on Masking Characters

- The wildcard characters dollar sign (\$) and dollar sign with an asterisk (\$*), which are used with IS operators, are treated as literals with LIKE operators.
- Masking with the characters \$ and \$* is not supported for compound WHERE phrases that use the AND or OR logical operators.

Screening on Initial Characters

To list all employees who have taken basic-level courses, where every basic course begins with the word BASIC, issue the following request:

```
TABLE FILE EMPLOYEE
PRINT COURSE_NAME COURSE_CODE
BY LAST_NAME BY FIRST_NAME
WHERE COURSE_NAME LIKE 'BASIC%'
END
```

The output is:

LAST_NAME	FIRST_NAME	COURSE_NAME	COURSE_CODE
-----	-----	-----	-----
BLACKWOOD	ROSEMARIE	BASIC REPORT PREP NON-PROG	102
CROSS	BARBARA	BASIC REPORT PREP DP MGRS	107
JONES	DIANE	BASIC REPORT PREP FOR PROG	103
SMITH	MARY	BASIC REPORT PREP FOR PROG	103
	RICHARD	BASIC RPT NON-DP MGRS	108

<u>LAST_NAME</u>	<u>FIRST_NAME</u>	<u>COURSE_NAME</u>	<u>COURSE_CODE</u>
BLACKWOOD	ROSEMARIE	BASIC REPORT PREP NON-PROG	102
CROSS	BARBARA	BASIC REPORT PREP DP MGRS	107
JONES	DIANE	BASIC REPORT PREP FOR PROG	103
SMITH	MARY	BASIC REPORT PREP FOR PROG	103
SMITH	RICHARD	BASIC RPT NON-DP MGRS	108

Screening on Characters Anywhere in a Field

If you want to see which employees have taken a FOCUS course, but you do not know where the word FOCUS appears in the title, bracket the word FOCUS with wildcards (which is equivalent to using the CONTAINS operator):

```
TABLE FILE EMPLOYEE
PRINT COURSE_NAME COURSE_CODE
BY LAST_NAME BY FIRST_NAME
WHERE COURSE_NAME LIKE '%FOCUS%'
END
```

The output is:

LAST_NAME	FIRST_NAME	COURSE_NAME	COURSE_CODE
-----	-----	-----	-----
BLACKWOOD	ROSEMARIE	WHAT'S NEW IN FOCUS	202
JONES	DIANE	FOCUS INTERNALS	203

If you want to list all employees who have taken a 20x-series course, and you know that all of these courses have the same code except for the final character, issue the following request:

```
TABLE FILE EMPLOYEE
PRINT COURSE_NAME COURSE_CODE
BY LAST_NAME BY FIRST_NAME
```

```
WHERE COURSE_CODE LIKE '20_'
END
```

The output is:

LAST_NAME	FIRST_NAME	COURSE_NAME	COURSE_CODE
-----	-----	-----	-----
BLACKWOOD	ROSEMARIE	WHAT'S NEW IN FOCUS	202
JONES	DIANE	FOCUS INTERNALS	203
		ADVANCED TECHNIQUES	201

Screening on Initial Characters and Specific Length

The following example illustrates how to screen on initial characters and specify the length of the field value you are searching for. In this example, the WHERE phrase states that the last name must begin with BAN and be seven characters in length (the three initial characters BAN and the four placeholders, in this case, the dollar sign). The remaining characters in the field (positions 8 through 15) must be blank.

```
TABLE FILE EMPLOYEE
PRINT LAST_NAME
WHERE LAST_NAME IS 'BAN$$$$'
END
```

The output is:

```
LAST_NAME
-----
BANNING
```

Screening on Records of Unspecified Length

To retrieve records with unspecified lengths, use the dollar sign followed by an asterisk (\$*):

```
WHERE LAST_NAME IS 'BAN$*'

```

This phrase searches for last names that start with the letters BAN, regardless of the name length. The characters \$* reduce typing, and enable you to define a screen mask without knowing the exact length of the field you wish to retrieve.

Deactivate Wildcard Characters

```
SET EQTEST = {WILDCARD|EXACT}
```

where:

WILDCARD

Treats the \$ and \$* characters as wildcard characters. WILDCARD is the default value.

EXACT

Treats the \$ and \$* characters as normal characters, not wildcards, in IF tests and in WHERE tests that can be translated to IF tests.

Selecting Records With SET EQTEST

The following request against the VIDEOTR2 data source creates two similar email addresses:

- handy\$man@usa.com, which has a dollar sign.
- handyiman@usa.com, which has the letter i in the same position as the \$ character in the other email address.

```
DEFINE FILE VIDEOTR2
SMAIL/A18= IF EMAIL EQ 'handyman@usa.com'
          THEN 'handyiman@usa.com'
          ELSE EMAIL;
SMAIL/A18 = STRREP(18,SMAIL,1,'_',1,'$',18,SMAIL);
END
TABLE FILE VIDEOTR2
PRINT SMAIL
BY LASTNAME BY FIRSTNAME
WHERE SMAIL EQ 'handy$man@usa.com'
```

```
ON TABLE SET EQTEST WILDCARD
END
```

With SET EQTEST=WILDCARD (the default), the WHERE test **WHERE SMAIL IS 'handy\$man@usa.com'** returns both the record with the \$ in the address and the record with the letter i in the address because the \$ is treated as a wildcard character, and any character in that position causes the record to pass the screening test:

LASTNAME	FIRSTNAME	SMAIL
-----	-----	-----
HANDLER	EVAN	handy\$man@usa.com handyiman@usa.com

Changing the ON TABLE SET command to ON TABLE SET EQTEST EXACT returns just the ONE email address with the \$ character because the dollar sign is now treated as a normal character and only passes the test if there is an exact match:

LASTNAME	FIRSTNAME	SMAIL
-----	-----	-----
HANDLER	EVAN	handy\$man@usa.com

Using an Escape Character for LIKE

You can use an escape character in the LIKE syntax to treat the masking characters (% and _) as literals within the search pattern, rather than as wildcards. This technique enables you to search for these characters in the data. For related information, see [Screening on Masked Fields](#).

Use an Escape Character in a WHERE Phrase

Any single character can be used as an escape character, if prefaced with the word ESCAPE

```
WHERE fieldname LIKE 'mask' ESCAPE 'c'
```

where:

fieldname

Is any valid field name or alias to be evaluated in the selection test.

mask

Is the search pattern that you supply. The single quotation marks are required.

c

Is any single character that you identify as the escape character. If you embed the escape character in the mask, before a % or _, the % or _ character is treated as a literal, rather than as a wildcard. The single quotation marks are required.

Specify an Escape Character for a Mask in an IF Phrase

You can assign any single character as an escape character by prefacing it with the word ESCAPE in the LIKE or UNLIKE syntax

```
IF field {LIKE|UNLIKE} 'mask1' ESCAPE 'a' [OR 'mask2' ESCAPE 'b' ...
```

where:

field

Is any valid field name or alias to be evaluated in the selection test.

mask1, mask2

Are search patterns that you supply. The single quotation marks are required.

a, b ...

Are single characters that you identify as escape characters. Each mask can specify its own escape character or use the same character as other masks. If you embed the escape character in the mask, before a % or _, the % or _ character is treated as a literal, rather than as a wildcard. The single quotation marks are required if the mask contains blanks.

Usage Notes for Escape Characters

- The use of an escape character in front of any character other than %, _, and itself is ignored.
- The escape character itself can be escaped, thus becoming a normal character in a string (for example, 'abc\%\%').
- Only one escape character can be used per LIKE phrase in a WHERE phrase.
- The escape character is only in effect when the ESCAPE syntax is included in the LIKE phrase.
- Every LIKE phrase can provide its own escape character.
- If a WHERE criterion is used with literal OR phrases, the ESCAPE must be on the first OR phrase, and applies to all subsequent phrases in that WHERE expression. For example:

```
WHERE field LIKE 'ABCg_' ESCAPE 'g' OR 'ABCg%' OR 'g%ABC'
```

Using the Escape Character in a WHERE Phrase

The VIDEOTR2 data source contains an email address field. To search for the email address with the characters 'handy_' you can issue the following request:

```
TABLE FILE VIDEOTR2
PRINT CUSTID LASTNAME FIRSTNAME EMAIL
WHERE EMAIL LIKE 'handy_%'
END
```

Because the underscore character functions as a wildcard character, this request returns two instances, only one of which contains the underscore character.

The output is:

CUSTID	LASTNAME	FIRSTNAME	EMAIL
0944	HANDLER	EVAN	handy_man@usa.com
0944	HANDLER	EVAN	handyman@usa.com

To retrieve only the instance that contains the underscore character, you must indicate that the underscore should be treated as a normal character, not a wildcard. The following request retrieves only the instance with the underscore character in the email field:

```
TABLE FILE VIDEOTR2
PRINT CUSTID LASTNAME FIRSTNAME EMAIL
WHERE EMAIL LIKE 'handy\_%' ESCAPE '\'
END
```

The output is:

CUSTID	LASTNAME	FIRSTNAME	EMAIL
0944	HANDLER	EVAN	handy_man@usa.com

Using an Escape Character in an IF Phrase

The VIDEOTR2 data source contains an email address field. To search for email addresses with the characters 'handy_' you can issue the following request:

```
TABLE FILE VIDEOTR2
PRINT CUSTID LASTNAME FIRSTNAME EMAI
IF EMAIL LIKE 'handy_%'
END
```

Because the underscore character functions as a wildcard character, this request returns two instances, only one of which contains the underscore character.

The output is:

CUSTID	LASTNAME	FIRSTNAME	EMAIL
0944	HANDLER	EVAN	handy_man@usa.com
0944	HANDLER	EVAN	handyman@usa.com

To retrieve only the instance that contains the underscore character, you must indicate that the underscore should be treated as a normal character, not a wildcard. The following request retrieves only the instance with the underscore character in the email field:

```
TABLE FILE VIDEOTR2
PRINT CUSTID LASTNAME FIRSTNAME EMAI
IF EMAIL LIKE 'handy\_%' ESCAPE '\ '
END
```

The output is:

CUSTID	LASTNAME	FIRSTNAME	EMAIL
-----	-----	-----	-----
0944	HANDLER	EVAN	handy_man@usa.com

Qualifying Parent Segments Using INCLUDES and EXCLUDES

You can test whether instances of a given field in a child segment include or exclude all literals in a list using the INCLUDES and EXCLUDES operators. INCLUDES and EXCLUDES retrieve only parent records. You cannot print or list any field in the same segment as the field specified for the INCLUDES or EXCLUDES test.



Note: INCLUDES and EXCLUDES work only with multi-segment FOCUS data sources.

Usage Notes for INCLUDES and EXCLUDES

- Literals containing embedded blanks must be enclosed in single quotation marks.
- The total number of literals must be 31 or less.
- To use more than one INCLUDES or EXCLUDES phrase in a request, begin each phrase on a separate line.
- You can connect the literals you are testing for with ANDs and ORs; however, the ORs are changed to ANDs.

Selecting Records With INCLUDES and EXCLUDES

A request that contains the phrase

```
WHERE JOBCODE INCLUDES A01 OR B01
```

returns employee records with JOBCODE instances for both A01 and B01, as if you had used AND.

In the following example, for a record to be selected, its JOBCODE field must have values of both A01 and B01:

```
WHERE JOBCODE INCLUDES A01 AND B01
```

If either one is missing, the record is not selected for the report.

If the selection criterion is

```
WHERE JOBCODE EXCLUDES A01 AND B01
```

every record that does not have both values is selected for the report.

In the CAR data source, only England produces Jaguars and Jensens, and so the request

```
TABLE FILE CAR
PRINT COUNTRY
WHERE CAR INCLUDES JAGUAR AND JENSEN
END
```

generates this output:

```
COUNTRY
-----
ENGLAND
```

Selections Based on Group Key Values

Some data sources use group keys. A group key is a single key composed of several fields. You can use a group name to refer to group key fields.

To select records based on a group key value, you need to supply the value of each field. The values must be separated by the slash character (/).

Note that a WHERE phrase that refers to a group field cannot be used in conjunction with AND or OR. For related information, see [Using Compound Expressions for Record Selection](#).

Selecting Records Using Group Keys

Suppose that a data source has a group key named PRODNO, which contains three separate fields. The first is stored in alphanumeric format, the second as a packed decimal, and the third as an integer. A screening phrase on this group might be:

```
WHERE PRODNO EQ 'RS/62/83'
```

Setting Limits on the Number of Records Read

For some reports, a limited number of records is satisfactory. When the specified number of records is retrieved, record retrieval can stop. This is useful when:

- You are designing a new report, and you need only a few records from the actual data source to test your design.
- The database administrator needs to limit the size of reports by placing an upper limit on retrieval from very large data sources. This limit is attached to the user password.
- You know the number of records that meet the test criteria. You can specify that number so that the search does not continue beyond the last record that meets the criteria. For example, suppose only ten employees use electronic transfer of funds, and you want to retrieve only those records. The record limit would be ten, and retrieval would stop when the tenth record is retrieved. The data source would not be searched any further.

Limit the Number of Records Read

There are two ways to limit the number of records retrieved. You can use

```
WHERE RECORDLIMIT EQ n
```

where:

n

Is a number greater than 0, and indicates the number of records to be retrieved. This syntax can be used with FOCUS and non-FOCUS data sources.

For all non-FOCUS data sources, you can also use

```
WHERE READLIMIT EQ n
```

where:

n

Is a number greater than 0, and indicates the number of read operations (not records) to be performed. For details, see the appropriate data adapter manual.

 **Tip:** If an attempt is made to apply the READLIMIT test to a FOCUS data source, the request is processed correctly, but the READLIMIT phrase is ignored.

 **Note:** Using SET RECORDLIMIT disables AUTOINDEX.

Limiting the Number of Records Read

The following request retrieves four records, generating a four-line report:

```
TABLE FILE EMPLOYEE
PRINT LAST_NAME AND FIRST_NAME AND EMP_ID
WHERE RECORDLIMIT EQ 4
END
```

The output is:

```
LAST_NAME          FIRST_NAME  EMP_ID
-----          -
```

STEVENS	ALFRED	071382660
SMITH	MARY	112847612
JONES	DIANE	117593129
SMITH	RICHARD	119265415

Selecting Records Using IF Phrases

The IF phrase selects records to be included in a report, and offers a subset of the functionality of WHERE. For a list of supported IF operators, see [Using Operators in Record Selection Tests](#).

 **Tip:** Unless you specifically require IF syntax (for example, to support legacy applications), we recommend using WHERE.

Select Records Using the IF Phrase

```
IF fieldname operator literal [OR literal]
```

where:

fieldname

Is the field you want to test (the test value).

operator

Is the type of selection operator you want. Valid operators are described in [Operators Supported for WHERE and IF Tests](#).

literal

Can be the MISSING keyword (as described in [Types of Record Selection Tests](#)) or alphanumeric or numeric values that are in your data source, with the word OR between values.

Note that all literals that contain blanks (for example, New York City) and all date and date-time literals must be enclosed within single quotation marks.

i Note: The IF phrase alone cannot be used to create compound expressions by connecting simple expressions with AND and OR logical operators. Compound logic requires that the IF phrase be used with the DEFINE command, as described in [Using Expressions](#). You can accomplish this more easily with WHERE. See [Using Compound Expressions for Record Selection](#).

Using Multiple IF Phrases

You can use as many IF phrases as necessary to define all your selection criteria, as illustrated in the following example:

```
TABLE FILE EMPLOYEE
PRINT EMP_ID LAST_NAME
IF SALARY GT 20000
IF DEPARTMENT IS MIS
IF LAST_NAME IS CROSS OR BANNING
END
```

All of these criteria must be satisfied in order for a record to be included in a report. The output is:

```
EMP_ID      LAST_NAME
-----
818692173  CROSS
```

Reading Selection Values From a File

Instead of typing literal test values in a WHERE or IF phrase, you can store them in a file and refer to the file in the report request. You can then select records based on equality or inequality tests on values stored in the file.

This method has the following advantages:

- You can save time by coding a large set of selection values once, then using these values as a set in as many report requests as you wish. You can also ensure consistency by maintaining the criteria in just one location.

- If the selection values already exist in a data source, you can quickly create a file of selection values by generating a report and saving the output in a HOLD or SAVE file. You can then read selection values from that file.

Values from a HOLD file (with a data description) can be in either BINARY format (the default) or ALPHA (simple character) format. If you use a SAVE file, it must be in ALPHA format (the default). Using a SAVB file is only valid for alphanumeric values. For information on HOLD and SAVE files, see [Saving and Reusing Your Report Output](#).

Note that a HOLD file in BINARY format that is used for selection values must be allocated to ddname HOLD (the default). The other extract files used for this purpose can be allocated to any ddname.

- You can include entries with mixed-case and special characters.

Read Selection Values From a File: WHERE field IN file

```
WHERE [NOT] fieldname IN FILE file
```

where:

fieldname

Is the name of the selection field. It can be any real or temporary field in the data source.

file

Is the name of the file.

Two-part names (app/file) are not supported. The file name is the ddname assigned by a DYNAM or TSO ALLOCATE command.

For related information, see [Usage Notes for Reading Values From a File](#).

Read Selection Values From a File: WHERE field operator (file)

```
WHERE field1 operator1 (file1) [{OR|AND} field2 operator2 (file2) ... ]
```

where:

field1, field2

Are any valid field names or aliases.

operator1, operator2

Can be the EQ, IS, NE, or IS-NOT operator.

file1, file1

Are the names of the files.

Two-part names (app/file) are not supported. The file name is the ddname assigned by a DYNAM or TSO ALLOCATE command.

Read Selection Values From a File: IF

```
IF fieldname operator (file) [OR (file) ... ]
```

where:

fieldname

Is any valid field name or alias.

operator

Is the EQ, IS, NE, or IS-NOT operator (see [Operators Supported for WHERE and IF Tests](#)).

file

Is the name of the file.

Two-part names (app/file) are not supported. The file name is the ddname assigned by a DYNAM or TSO ALLOCATE command.

Usage Notes for Reading Values From a File

In order to read selection criteria from a file, the file must comply with the following rules:

- Each value in the file must be on a separate line.
For IF, more information can appear on a line, but only the first data value encountered on the line is used.
- The selection value must start in column one.
- The values are assumed to be in character format, unless the file name is HOLD, and numeric digits are converted to internal computational numbers where needed (for example, binary integer).
- The maximum number of values is 32,767.
- For WHERE, alphanumeric values with embedded blanks or any mathematical operator (-, +, *, /) must be enclosed in single quotation marks.
- For WHERE, when a compound WHERE phrase uses IN FILE more than once, the specified files must have the same record formats.
If your list of literals is too large, an error is displayed.
- For IF, sets of file names may be used, separated by the word OR, and with WHERE, AND. The file names cannot be prefaced with app names. Actual literals may also be mixed with the file names. For example:

```
IF fieldname operator (filename) OR literal...etc...
```

Reading Selection Values From a File (WHERE field IN file)

Create a file named EXPER, which contains the values B141 and B142.

This request uses selection criteria from the file EXPER. You must allocate or FILEDEF the EXPER file prior to running the request. For example, if the file is named exper.ftm and it is in the baseapp application, you can issue the following FILEDEF command:

```
FILEDEF EXPER DISK baseapp/exper.ftm
```

All records for which PRODUCT_ID has a value of B141 or B142 are selected:

```
TABLE FILE GGPRODS
SUM UNIT_PRICE
BY PRODUCT_DESCRIPTION
WHERE PRODUCT_ID IN FILE EXPER
END
```

If you include the selection criteria directly in the request, the WHERE phrase specifies the values explicitly:

```
WHERE PRODUCT_DESCRIPTION EQ 'B141' or 'B142'
```

The output is:

Product	Unit Price
-----	-----
French Roast	81.00
Hazelnut	58.00

Reading Selection Values From a File With WHERE field operator (file)

The following request against the GGPRODS data source creates a HOLD file named EXPER1 that contains product IDs B141, B142, B143, and B144.

```
TABLE FILE GGPRODS
BY PRODUCT_ID BY PRODUCT_DESCRIPTION
WHERE PRODUCT_ID EQ 'B141' OR 'B142' OR 'B143' OR 'B144'
ON TABLE HOLD AS EXPER1 FORMAT ALPHA
END
```

The following request against the GGPRODS data source creates a HOLD file named EXPER2 that contains product IDs B144, F101, and F102.

```
TABLE FILE GGPRODS
BY PRODUCT_ID BY PRODUCT_DESCRIPTION
WHERE PRODUCT_ID EQ 'B144' OR 'F101' OR 'F102'
ON TABLE HOLD AS EXPER2 FORMAT ALPHA
END
```

The following request selects the values that exist in both EXPER1 AND EXPER2.

```
TABLE FILE GGPRODS
SUM PRODUCT_DESCRIPTION
BY PRODUCT_ID
WHERE PRODUCT_ID EQ (EXPER1) AND PRODUCT_ID IS (EXPER2)
ON TABLE SET PAGE NOPAGE
END
```

The output is:

```
Product
Code      Product
-----
B144      Kona
```

Reading Selection Values From a File (IF)

Create a file named EXPER, which contains the values B141 and B142.

This request uses selection criteria from the file EXPER. All records for which PRODUCT_ID has a value of B141 or B142 are selected:

```
TABLE FILE GGPRODS
SUM UNIT_PRICE
BY PRODUCT_DESCRIPTION
IF PRODUCT_ID IS (EXPER)
END
```

If you include the selection criteria directly in the request, the IF phrase specifies the values explicitly:

```
IF PRODUCT_DESCRIPTION EQ 'B141' or 'B142'
```

The output is:

Product	Unit Price
-----	-----
French Roast	81.00
Hazelnut	58.00

Assigning Screening Conditions to a File

You can assign screening conditions to a data source, independent of a request, and activate these screening conditions for use in report requests against the data source.

A filter is a packet of definitions that resides at the file level, containing WHERE and/or IF criteria. Whenever a report request is issued against a data source, all filters that have been activated for that data source are in effect. WHERE or IF syntax that is valid in a report request is also valid in a filter.

A filter can be declared at any time before the report request is run. The filters are available to subsequent requests during the session in which the filters have been run. For details, see [Assigning Screening Conditions to a File](#).

Filters allow you to:

- Declare a common set of screening conditions that apply each time you retrieve data from a data source. You can declare one or more filters for a data source.
- Declare a set of screening conditions and dynamically turn them on and off.
- Limit access to data without specifying rules in the Master File.

In an interactive environment, filters also reduce repetitive ad hoc typing.



Note: Simply declaring a filter for a data source does *not* make it active. A filter must be activated with a SET command. For details, see [Assigning Screening Conditions to a File](#).

Declare a Filter

A filter can be described by the following declaration

```
FILTER FILE filename [CLEAR|ADD]
  [filter-defines;]
  NAME=filtername1 [,DESC=text]
  where-if phrases .
  .
  .
  NAME=filternamen [,DESC=text]
  where-if phrases END
```

where:

filename

Is the name of the Master File to which the filters apply.

CLEAR

Deletes any existing filter phrases, including any previously defined virtual fields.

ADD

Enables you to add new filter phrases to an existing filter declaration without clearing previously defined filters.

filter-defines

Are virtual fields declared for use in filters. For more information, see [Usage Notes for Virtual Fields Used in Filters](#).

filtername1...filternamen

Is the name by which the filter is referenced in subsequent SET FILTER commands. This name may be up to 66 characters long and must be unique for a particular file name.

text

Describes the filter for documentation purposes. Text must fit on one line.

where-if phrases

Are screening conditions that can include all valid syntax. They may refer to data source fields and virtual fields in the Master File. They may not refer to virtual fields declared using a DEFINE command, or to other filter names.

Usage Notes for Virtual Fields Used in Filters

Virtual fields used in filters:

- Are exclusively local to (or usable by) filters in a specific filter declaration.
- Cannot be referenced in a DEFINE or TABLE command.
- Support any syntax valid for virtual fields in a DEFINE command.
- Cannot reference virtual fields in a DEFINE command, but can reference virtual fields in the Master File.
- Do not count toward the display field limit, unlike virtual fields in DEFINE commands.
- Must all be declared before the first named filter.
- Must each end with a semi-colon.
- Cannot be enclosed between the DEFINE FILE and END commands.
- Cannot reuse a virtual field name for the same file.

Declaring Filters

The first example creates the filter named UK, which consists of one WHERE condition. It also adds a definition for the virtual field MARK_UP to the set of virtual fields already being used in filters for the CAR data source.

When a report request is issued for CAR, with UK activated, the condition WHERE MARK_UP is greater than 1000 is automatically added to the request.



Note: The virtual field MARK_UP cannot be explicitly displayed or referenced in the TABLE request.

```
FILTER FILE CAR ADD
MARK_UP/D7=RCOST-DCOST;
NAME=UK
WHERE MARK_UP GT 1000
END
```

The second example declares three named filters for the CAR data source: ASIA, UK, and LUXURY. The filter ASIA contains a textual description, for documentation purposes only. CLEAR, on the first line, erases any previously existing filters for CAR, as well any previously defined virtual fields used in filters for CAR, before it processes the new definitions.

```
FILTER FILE CAR CLEAR
NAME=ASIA,DESC=Asian cars only
IF COUNTRY EQ JAPAN
NAME=UK
IF COUNTRY EQ ENGLAND
NAME=LUXURY
IF RETAIL_COST GT 50000
END
```

Activate or Deactivate Filters

Filters can be activated and deactivated with the command

```
SET FILTER= {*|xx[yy zz]} IN {file|*} {ON|OFF}
```

where:

—

Denotes all declared filters. This is the default value.

xx, yy, zz

Are the names of filters as declared in the NAME = syntax of the FILTER FILE command.

file

Is the name of the data source to which you are assigning screening conditions. * denotes all data sources.

ON

Activates all (*) or specifically named filters for the data source or all data sources (*). The maximum number of filters you can activate for a data source is limited by the number of WHERE/IF phrases that the filters contain, not to exceed the limit of WHERE/IF criteria in any single report request.

OFF

Deactivates all (*) or specifically named filters for the data source or all data sources (*). OFF is the default value.

i Note: The SET FILTER command is limited to one line. To activate more filters than fit on one line, issue additional SET FILTER commands. As long as you specify ON, the effect is cumulative.

Activating and Deactivating Filters

The following commands activate A, B, C, D, E, F, and deactivate G (assuming that it was set ON, previously):

```
SET FILTER = A B C IN CAR ON
SET FILTER = D E F IN CAR ON
SET FILTER = G IN CAR OFF
```

The following commands activate some filters and deactivate others:

```
SET FILTER = UK LUXURY IN CAR ON
...
TABLE FILE CAR
PRINT COUNTRY MODEL RETAIL_COST
END
...
SET FILTER = LUXURY IN CAR OFF
TABLE FILE CAR
PRINT COUNTRY MODEL RETAIL_COST
END
```

The first SET FILTER command activates the filters UK and LUXURY, assigned to the CAR data source, and applies their screening conditions to any subsequent report request against the CAR data source.

The second SET FILTER command deactivates the filter LUXURY for the CAR data source. Unless LUXURY is reactivated, any subsequent report request against CAR will not apply the conditions in LUXURY, but will continue to apply UK.

Query the Status of Filters

To determine the status of existing filters, use

```
? FILTER [{{file|*}}] [SET] [ALL]]
```

where:

file

Is the name of a Master File.

Displays filters for all Master Files for which filters have been declared.

SET

Displays only active filters.

ALL

Displays all information about the filter, including its description and the exact WHERE/IF definition.

Querying Filters

To query filters, issue the following command:

```
FILTER FILE CAR CLEAR  
NAME=BOTH, DESC=Asian and British cars only  
IF COUNTRY EQ JAPAN AND ENGLAND  
END  
SET FILTER =BOTH IN CAR ON  
TABLE FILE CAR  
PRINT CAR RETAIL_COST  
BY COUNTRY  
END
```

The output is:

COUNTRY	CAR	RETAIL_COST
-----	---	-----
ENGLAND	JAGUAR	8,878
	JAGUAR	13,491
	JENSEN	17,850
	TRIUMPH	5,100
JAPAN	DATSUN	3,139
	TOYOTA	3,339

The following example queries filters for all data sources:

```
? FILTER
```

If no filters are defined, the following message displays:

```
NO FILTERS DEFINED
```

If filters are defined, the following screen displays:

Set	File	Filter name	Description
---	-----	-----	-----
	CAR	ROB	Rob's selections
*	CAR	PETER	Peter's selections for CAR
*	EMPLOYEE	DAVE	Dave's tests
	EMPLOYEE	BRAD	Brad's tests

To query filters for the CAR data source, issue:

```
? FILTER CAR
```

If no filters are defined for the CAR data source, the following message displays:

```
NO FILTERS DEFINED FOR FILE NAMED CAR
```

If filters are defined for the CAR data source, the following screen displays:

Set	File	Filter name	Description
---	-----	-----	-----
	CAR	ROB	Rob's selections
*	CAR	PETER	Peter's selections for CAR

To see all active filters, issue the following command:

```
? FILTER * SET
```

The output is:

Set	File	Filter name	Description
*	CAR	PETER	Peter's selections for CAR
*	EMPLOYEE	DAVE	Dave's tests

The asterisk in the first column indicates that a filter is activated.

Preserving Filters Across Joins

By default, filters defined on the host data source are cleared by a JOIN command. However, filters can be maintained when a JOIN command is issued, by issuing the SET KEEPFILTERS=ON command.

Setting KEEPFILTERS to ON reinstates filter definitions and their individual declared status after a JOIN command. The set of filters and virtual fields defined prior to each join is called a context (see your documentation on SET KEEPDEFINES and on DEFINE FILE SAVE for information about contexts as they relate to virtual fields). Each new JOIN or DEFINE FILE command creates a new context.

If a new filter is defined after a JOIN command, it cannot have the same name as any previously defined filter unless you issue the FILTER FILE command with the CLEAR option. The CLEAR option clears all filter definitions for that data source in all contexts.

When a JOIN is cleared, each filter definition that was in effect prior to the JOIN command and that was not cleared, is reinstated with its original status. Clearing a join by issuing the JOIN CLEAR join_name command removes all of the contexts and filter definitions that were created after the JOIN join_name command was issued.

i Note: When an error occurs because of a reference to a field that does not exist in the original FILTER FILE, the filter is disabled even though KEEPFILTERS is set to ON.

Preserve Filter Definitions With KEEPFILTERS

```
SET KEEPFILTERS = {OFF|ON}
```

where:

OFF

Does not preserve filters issued prior to a join. OFF is the default value.

ON

Preserves filters across joins.

Preserving Filters With KEEPFILTERS

The first filter, UNITPR, is defined prior to issuing any joins, but after setting KEEPFILTERS to ON:

```
SET KEEPFILTERS = ON
FILTER FILE VIDEOTRK
PERUNIT/F5 = TRANSTOT/QUANTITY;
NAME=UNITPR
WHERE PERUNIT GT 2
WHERE LASTNAME LE 'CRUZ'
END
```

The ? FILTER command shows that the filter named UNITPR was created but not activated (activation is indicated by an asterisk in the SET column of the display:

```
? FILTER

SET FILE      FILTER NAME DESCRIPTION
-----
VIDEOTRK UNITPR
```

Next, the filter is activated:

```
SET FILTER= UNITPR IN VIDEOTRK ON
```

The ? FILTER query shows that the filter is now activated:

```
? FILTER
```

```
SET FILE      FILTER NAME DESCRIPTION
-----
```

```
*  VIDEOTRK UNITPR
```

The following TABLE request is issued against the filtered data source:

```
TABLE FILE VIDEOTRK
SUM QUANTITY TRANSTOT BY LASTNAME
END
```

The output shows that the TABLE request retrieved only the data that satisfies the UNITPR filter:

```
NUMBER OF RECORDS IN TABLE=          6  LINES=          3
ACCESS LIMITED BY FILTERS
```

```
PAUSE.. PLEASE ISSUE CARRIAGE RETURN WHEN READY
```

LASTNAME	QUANTITY	TRANSTOT
-----	-----	-----
CHANG	3	31.00
COLE	2	18.98
CRUZ	2	16.00

Now, the VIDEOTRK data source is joined to the MOVIES data source. The ? FILTER query shows that the join did not clear the UNITPR filter:

```
JOIN MOVIECODE IN VIDEOTRK TO ALL MOVIECODE IN MOVIES AS J1
```

The ? FILTER command shows that the UNITPR filter still exists and is still activated:

```
? FILTER
```

```
SET FILE      FILTER NAME DESCRIPTION
-----
```

```
*  VIDEOTRK UNITPR
```

Next a new filter, YEARS1, is created and activated for the join between VIDEOTRK and MOVIES:

```

FILTER FILE VIDEOTRK
YEARS/I5 = (EXPDATE - TRANSDATE)/365;
NAME=YEARS1
WHERE YEARS GT 1
END
SET FILTER= YEARS1 IN VIDEOTRK ON

```

The ? FILTER query shows that both the UNITPR and YEARS1 filters exist and are activated:

```

? FILTER

SET FILE      FILTER NAME DESCRIPTION
-----
*  VIDEOTRK  UNITPR
*  VIDEOTRK  YEARS1

```

Now, J1 is cleared. The output of the ? FILTER command shows that the YEARS1 filter that was created after the JOIN command was issued no longer exists. The UNITPR filter created prior to the JOIN command still exists with its original status:

```

JOIN CLEAR J1
? FILTER

SET FILE      FILTER NAME DESCRIPTION
-----
*  VIDEOTRK  UNITPR

```

VSAM Record Selection Efficiencies

The most efficient way to retrieve selected records from a VSAM KSDS data source is by applying an IF screening test against the primary key. This results in a direct reading of the data using the data source's index. Only those records that you request are retrieved from the file. The alternative method of retrieval, the sequential read, forces the data adapter to retrieve all the records into storage.

Selection criteria that are based on the entire primary key, or on a subset of the primary key, cause direct reads using the index. A partial key is any contiguous part of the primary key beginning with the first byte.

IF selection tests performed against virtual fields can take advantage of these efficiencies as well, if the full or partial key is embedded in the virtual field.

The EQ and IS relations realize the greatest performance improvement over sequential reads. When testing on a partial key, equality logic is used to retrieve only the first segment instance of the screening value. To retrieve subsequent instances, the NEXT logic is used.

Screening relations GE, FROM, FROM-TO, GT, EXCEEDS, IS-MORE-THAN, and NOT-FROM-TO all obtain some benefit from direct reads. The following example uses the index to find the record containing the primary key value 66:

```
IF keyfield GE 66
```

It then continues to retrieve records by sequential processing, because VSAM stores records in ascending key sequence. The direct read is not attempted when the IF screening conditions NE, IS-NOT, CONTAINS, OMITS, LT, IS-LESS-THAN, LE, and NOT-FROM are used in the report request.

Reporting From Files With Alternate Indexes

Similar performance improvement is available for ESDS and KSDS files that use alternate indexes. An alternate index provides access to records in a key-sequenced data set based on a key other than the primary key.

All benefits and limitations inherent with screening on the primary or partial key are applicable to screening on the alternate index or partial alternate index.

i Note: It is not necessary to take an explicit indexed view to use the index.

Creating Temporary Fields

When you create a report, you are not restricted to the fields that exist in your data source. If you can generate the information you want from the existing data, you can create a temporary field to evaluate and display it. A temporary field takes up no storage space in the data source. It is created only when needed.

What Is a Temporary Field?

A temporary field is a field whose value is not stored in the data source, but can be calculated from the data that is there, or assigned an absolute value. A temporary field takes up no storage space in the data source, and is created only when needed.

When you create a temporary field, you determine its value by writing an expression. You can combine fields, constants, and operators in an expression to produce a single value. For example, if your data contains salary and deduction amounts, you can calculate the ratio of deductions to salaries using the following expression:

```
deduction / salary
```

You can specify the expression yourself, or you can use one of the many supplied functions that perform specific calculations or manipulations. In addition, you can use expressions and functions as building blocks for more complex expressions, as well as use one temporary field to evaluate another.

Types of Temporary Fields

You can use two types of temporary fields (a *virtual field* and a *calculated value*), which differ in how they are evaluated:

A virtual field (DEFINE) is evaluated as each record that meets the selection criteria is retrieved from the data source. The result of the expression is treated as though it were a real field stored in the data source. A virtual field is in effect until it is cleared.

A calculated value (COMPUTE) is evaluated after all the data that meets the selection criteria is retrieved, sorted, and summed. Therefore, the calculation is performed using the aggregated values of the fields.

Evaluation of Temporary Fields

The following illustration shows how a request processes, and when each type of temporary field is evaluated:

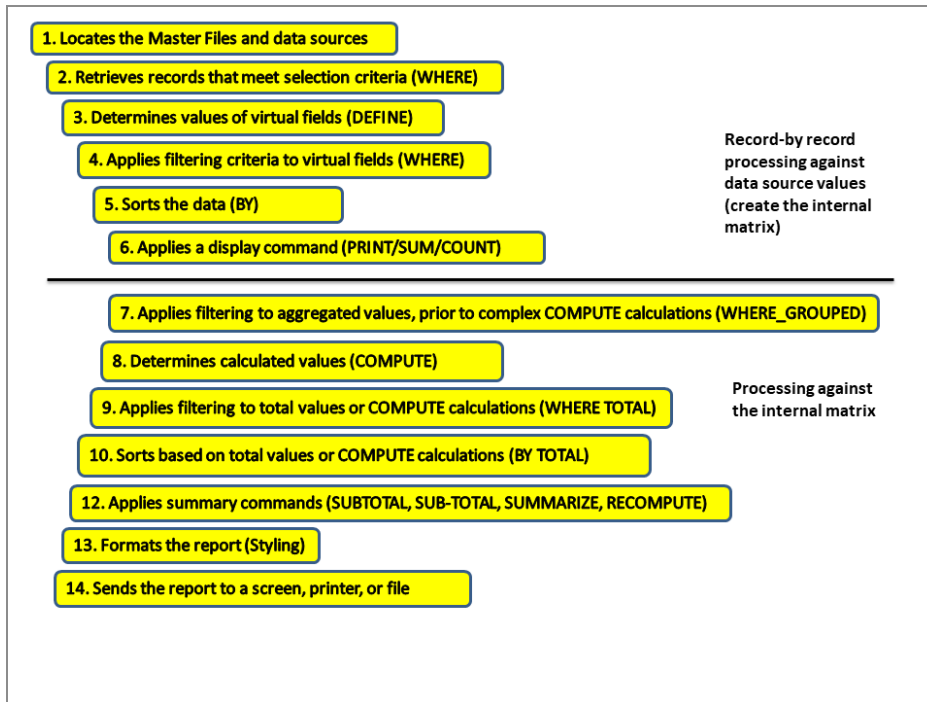

Distinguishing Between Virtual Fields and Calculated Values

In the following example, both the DRATIO field (virtual field) and the CRATIO (calculated value) use the same expression $\text{DELIVER_AMT} / \text{OPENING_AMT}$, but do not return the same result. The value for CRATIO is calculated after all records have been selected, sorted, and aggregated. The virtual field DRATIO is calculated for each retrieved record.

```

DEFINE FILE SALES
DRATIO = DELIVER_AMT/OPENING_AMT;
END
TABLE FILE SALES
SUM DELIVER_AMT AND OPENING_AMT AND DRATIO
COMPUTE CRATIO = DELIVER_AMT/OPENING_AMT;
END

```

The output is:

<u>DELIVER_AMT</u>	<u>OPENING_AMT</u>	<u>DRATIO</u>	<u>CRATIO</u>
760	724	28.41	1.05

DELIVER_AMT	OPENING_AMT	DRATIO	CRATIO
-----	-----	-----	-----
760	724	28.41	1.05

Selecting a Temporary Field

The following is to help you choose the kind of temporary field you need.

Choose a virtual field when you want to:

- Use the temporary field to select data for your report. You cannot use a calculated value, since it is evaluated after data selection takes place.
- Use the temporary field to sort on data values. A calculated value is evaluated after the data is sorted. With the BY TOTAL phrase, you can sort on this type of field.

Choose a calculated value when you want to:

- Evaluate the temporary field using total values or prefix operators (which operate on total values). You cannot use a virtual field, since it is evaluated before any totaling takes place.
- Evaluate the temporary field using fields from different paths in the data structure. You cannot use a virtual field, since it is evaluated before the relationship between data in the different paths is established.

Defining a Virtual Field

A virtual field can be used in a request as though it is a real data source field. The calculation that determines the value of a virtual field is performed on each retrieved record that passes any screening conditions on real fields. The result of the expression is treated as though it were a real field stored in the data source.

You can define a virtual field in the following ways:

- **In a Master File.** These virtual fields are available whenever the data source is used for reporting. These fields cannot be cleared by JOIN or DEFINE FILE commands. For more information, see the *ibi™ FOCUS® Describing Data* manual.
- **In a procedure.** A virtual field created in a procedure lasts either for the session or until it is cleared by a:
 - DEFINE FILE *filename* CLEAR command.
 - Subsequent DEFINE command without the ADD phrase against the same data source.
 - JOIN command.

✔ **Tip:** If your environment supports the KEEPDEFINES parameter, you can set KEEPDEFINES to ON or ALL to protect virtual fields from being cleared by a subsequent JOIN command.

Usage Notes for Creating Virtual Fields

- If you do not use the KEEPDEFINES parameter, when a JOIN is issued, all pre-existing virtual fields for that data source are cleared except those defined in the Master File.
- To join structures using a virtual field with the source, make sure the DEFINE follows the JOIN command. Otherwise, the JOIN command clears the temporary field. For an explanation of reporting on joined data sources, see [Joining Data Sources](#).
- If no field in the expression is in the Master File or has been defined, use the WITH command to identify the logical home of the defined calculation. See [Establishing a Segment Location for a Virtual Field](#).

- WITH can be used to move the logical home for the virtual field to a segment lower than that to which it would otherwise be assigned (for example, to count instances in a lower segment).
- You may define fields simultaneously (in addition to fields defined in the Master File) for as many data sources as desired. The total length of all virtual fields and real fields cannot exceed 32,000 characters.
- When you specify virtual fields in a request, they count toward the display field limit. For details on determining the maximum number of display fields that can be used in a request, see [Displaying Report Data](#).
- Virtual fields are only available when the data source is used for reporting. Virtual fields cannot be used with MODIFY.
- A DEFINE command may not contain qualified field names on the left-hand side of the expression. If the same field name exists in more than one segment, and that field must be redefined or recomputed, use the REDEFINES command.
- Using a self-referencing DEFINE such as `x=x+1` disables AUTOPATH (see the *ibi™ FOCUS® Developing Applications* manual).
- Field names used in the expression that defines the virtual field cannot be enclosed in single or double quotation marks. Any character string enclosed in quotation marks is treated as a literal string, not a field reference.
- A DEFINE FILE command overwrites a DEFINE in the Master File with same name as long as you do not redefine the format (which is not allowed).

Create a Virtual Field

Before you begin a report request, include

```
DEFINE FILE filename[.view_fieldname] [CLEAR|ADD]
fieldname[/format] [(GEOGRAPHIC_ROLE = georole]
    [,TITLE = 'line1[,line2 ...']]
    [,DESCRIPTION = 'description']] = expression;
fieldname[/format][WITH realfield] = expression;
fieldname[/format] REDEFINES qualifier.fieldname = expression;
.
.
.
END
```

where:

filename

Is the name of the data source for which you are defining the virtual field.

If the report request specifies an alternate view, use *filename* in conjunction with *view_fieldname*.

All fields used to define the virtual field must lie on a single path in the data source. If they do not, you can use an alternate view, which requires alternate view DEFINE commands. For an alternate view, virtual fields cannot have qualified field names. For information on alternate views, see [Rotating a Data Structure for Enhanced Retrieval](#).

The DEFINE FILE command line must be on a separate line from its virtual field definitions.

view_fieldname

Is the field on which an alternate view is based in the corresponding request. You may need to use an alternate view if the fields used do not lie on a single path in the normal view.

CLEAR

Clears previously defined virtual fields associated with the specified data source. CLEAR is the default value.

ADD

Enables you to specify additional virtual fields for a data source without releasing any existing virtual fields. Omitting ADD produces the same results as the CLEAR option.

fieldname

Is a name that complies with FOCUS field naming rules. Indexed field names in FOCUS data sources must be less than or equal to 12 characters. It can be the name of a new virtual field that you are defining, or an existing field declared in the Master File, which you want to redefine.

The name can include any combination of letters, digits, and underscores (_), and should begin with a letter.

Do not use field names of the type *Cn*, *En*, or *Xn* (where *n* is any sequence of one or two digits), because they are reserved for other uses.

format

Is the format of the field. The default value is D12.2. For information on field formats, see the *ibi™ FOCUS® Describing Data* manual.

georole

Is a valid geographic role. The following is a list of default geographic roles.

- **ADDRESS_FULL.** Full address.
- **ADDRESS_LINE.** Number and street name.
- **CITY.** City name.
- **CONTINENT.** Continent name.
- **COUNTY.** County name.
- **COUNTRY.** Country name.
- **GEOMETRY_AREA.** Geometry area.
- **GEOMETRY_LINE.** Geometry line.
- **GEOMETRY_POINT.** Geometry point.
- **LATITUDE.** Latitude.
- **LONGITUDE.** Longitude.
- **POSTAL_CODE.** Postal code.
- **STATE.** State name.

WITH realfield

Associates a virtual field with a data source segment containing a real field. For more information, see [Usage Notes for Creating Virtual Fields](#).

line1, line2...

Are the lines of default column title to be displayed for the virtual field unless overridden by an AS phrase.

description

Is the description to be associated with the virtual field, enclosed in single quotation marks.

REDEFINES qualifier.fieldname

Enables you to redefine or recompute a field whose name exists in more than one segment. If you change the format of the field when redefining it, the length in the new format must be the same as or shorter than the original. In addition, conversion between alphanumeric and numeric data types is not supported.

expression

Can be an arithmetic or logical expression or function, evaluated to establish the value of *fieldname* (see [Using Expressions](#)). You must end each expression with a semicolon except for the last one, where the semicolon is optional.

Fields in the expression can be real data fields, data fields in data sources that are cross-referenced or joined, or previously defined virtual fields. For related information, see [Usage Notes for Creating Virtual Fields](#).

END

Is required to end the DEFINE FILE command. END must be on its own line in the procedure.



Note: For information about missing attributes for virtual fields, see [Missing Field Values](#).

Defining a Virtual Field

In the following request, the value of `RATIO` is calculated by dividing the value of `DELIVER_AMT` by `OPENING_AMT`. The `DEFINE` command creates `RATIO` as a virtual field, which is used in the request as though it were a real field in the data source.

```
DEFINE FILE SALES
RATIO = DELIVER_AMT/OPENING_AMT;
END
TABLE FILE SALES
PRINT DELIVER_AMT AND OPENING_AMT AND RATIO
WHERE DELIVER_AMT GT 50
END
```

The output is:

DELIVER_AMT	OPENING_AMT	RATIO
-----	-----	-----
80	65	1.23
100	100	1.00
80	90	.89

Redefining a Field

The following request redefines the salary field in the EMPDATA data source to print asterisks for job titles that contain the word EXECUTIVE:

```

SET EXTENDNUM=OFF
DEFINE FILE EMPDATA
SALARY REDEFINES EMPDATA.SALARY =
  IF TITLE CONTAINS 'EXECUTIVE' THEN ELSE
  EMPDATA.SALARY;
END
TABLE FILE EMPDATA
SUM SALARY BY TITLE
WHERE TITLE CONTAINS 'MANAGER' OR 'MARKETING' OR 'SALES'
ON TABLE SET PAGE OFF
END

```

The output is:

TITLE	SALARY
-----	-----
EXEC MANAGER	\$54,100.00
EXECUTIVE MANAGER	*****
MANAGER	\$270,500.00
MARKETING DIRECTOR	\$176,800.00
MARKETING EXECUTIVE	*****
MARKETING SUPERVISOR	\$50,500.00
SALES EXECUTIVE	*****
SALES MANAGER	\$70,000.00
SALES SPECIALIST	\$82,000.00
SENIOR SALES EXEC.	\$43,400.00

Redefining a Field That Has the Same Name in Multiple Segments

The following request joins the EMPDATA data source to itself. This creates a two-segment structure in which the names are the same in both segments. The request then redefines the salary field in the top segment (tag name ORIG) so that all names starting with the letter L are replaced by asterisks, and redefines the salary field in the child segment (tag name NEW) so that all names starting with the letter M are replaced by asterisks:

```

SET EXTENDNUM=OFF
JOIN PIN IN EMPDATA TAG ORIG TO PIN IN EMPDATA TAG NEW AS AJ
DEFINE FILE EMPDATA
SALARY/D12.2M REDEFINES ORIG.SALARY = IF LASTNAME LIKE 'L%' THEN
                                     999999999999 ELSE ORIG.SALARY;
SALARY/D12.2M REDEFINES NEW.SALARY = IF LASTNAME LIKE 'M%' THEN
                                     999999999999 ELSE NEW.SALARY * 1.2;

END
TABLE FILE EMPDATA
PRINT ORIG.SALARY AS 'ORIGINAL' NEW.SALARY AS 'NEW'
BY LASTNAME
WHERE LASTNAME FROM 'HIRSCHMAN' TO 'OLSON'
ON TABLE SET PAGE NOPAGE
END

```

The output is:

LASTNAME	ORIGINAL	NEW
-----	-----	---
HIRSCHMAN	\$62,500.00	\$75,000.00
KASHMAN	\$33,300.00	\$39,960.00
LASTRA	*****	\$138,000.00
LEWIS	*****	\$60,600.00
LIEBER	*****	\$62,400.00
LOPEZ	*****	\$31,680.00
MARTIN	\$49,000.00	*****
MEDINA	\$39,000.00	*****
MORAN	\$30,800.00	*****
NOZAWA	\$80,500.00	\$96,600.00
OLSON	\$30,500.00	\$36,600.00

Defining Multiple Virtual Fields

You may wish to have more than one set of virtual fields for the same data source, and to use some or all of the virtual fields in the request. The ADD option enables you to specify additional virtual fields without clearing existing ones. If you omit the ADD option, previously defined virtual fields in that data source are cleared.

If you want to clear a virtual field for a particular data source, use the CLEAR option.

Add a Virtual Field to Existing Virtual Fields

```
DEFINE FILE filename ADD
```

where:

filename

Is the data source.

Adding Virtual Fields

The following annotated example illustrates the use of the ADD and CLEAR options for virtual fields:

```
1. DEFINE FILE CAR
   ETYPE/A2=DECODE STANDARD (OHV O OHC O ELSE L);
   END
2. DEFINE FILE CAR ADD
   TAX/D8.2=IF MPG LT 15 THEN .06*RCOST
     ELSE .04*RCOST;
   FCOST = RCOST+TAX;
   END
```

1. The first DEFINE command creates the TYPE virtual field for the CAR data source. For information about the DECODE function, see the *ibi™ WebFOCUS® Using Functions* manual.
2. Two or more virtual fields, TAX and FCOST, are created for the CAR data source. The

ADD option allows you to reference ETYPE, TAX, and FCOST in future requests.

Displaying Virtual Fields

You can display all virtual fields with the ? DEFINE command.

Display Virtual Fields

```
? DEFINE
```

For more information, see the *ibi™ FOCUS® Developing Applications* manual.

Display Virtual Fields

Click the **Defined Fields** tab in the Define tool.

Clearing a Virtual Field

The following can clear a virtual field created in a procedure:

- A DEFINE FILE *filename* CLEAR command.
- A subsequent DEFINE command (without the ADD option), against the same data source.
- A join. When a join is created for a data source, all pre-existing virtual fields for that data source are cleared except those defined in the Master File. This may affect virtual fields used in an expression.
- A change in the value of the FIELDNAME SET parameter.

Unlike fields created in a procedure, virtual fields in the Master File are not cleared in the above ways.

Clearing Virtual Fields

The following annotated example illustrates the use of the CLEAR options for virtual fields:

```

1. DEFINE FILE CAR
  ETYPE/A2=DECODE STANDARD (OHV 0 OHC 0 ELSE L);
  END
2. DEFINE FILE CAR CLEAR
  COST = RCOST-DCOST;
  END

```

1. The first DEFINE command creates the TYPE virtual field for the CAR data source. For information about the DECODE function, see the *ibi™ WebFOCUS® Using Functions* manual.
2. The CLEAR option clears the previously defined virtual fields, and only the COST virtual field in the last DEFINE is available for further requests.

Establishing a Segment Location for a Virtual Field

Virtual fields have a logical location in the data source structure, just like permanent data source fields. The logical home of a virtual field is on the lowest segment that has to be accessed in order to evaluate the expression, and determines the time of execution for that field. Consider the following data source structure and DEFINE command:

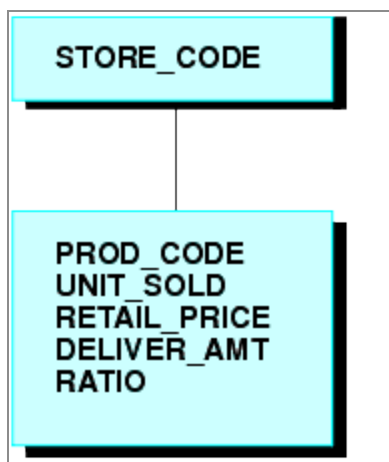

```
DEFINE RATIO = DELIVER_AMT/RETAIL_PRICE ;
```

The expression for RATIO includes at least one real data source field. As far as report capabilities are concerned, the field RATIO is just like a real field in the Master File, and is located in the lowest segment.

In some applications, you can have a virtual field evaluated by an expression that contains no real data source fields. Such an expression might refer only to temporary fields or literals. For example,

```
NCOUNT/I5 = NCOUNT+1;
```

or

```
DATE/YMD = '19990101' ;
```

Since neither expression contains a data source field (NCOUNT and the literal do not exist in the Master File), their logical positions in the data source cannot be determined. You have to specify in which segment you want the expression to be placed. To associate a virtual field with a specific segment, use the WITH phrase. The field name following WITH may be any real field in the Master File.

For FOCUS data sources, you may be able to increase the retrieval speed with an external index on the virtual field. In this case, you can associate the index with a target segment outside of the segment containing the virtual field. See the *ibi™ FOCUS® Developing Applications* manual for more information on external indexes.

Establishing a Segment Location

The field NCOUNT is placed in the same segment as the UNITS field. NCOUNT is calculated each time a new segment instance is retrieved.

```
DEFINE FILE GGSales
NCOUNT/I5 WITH UNITS = NCOUNT+1;
END
```

Defining Virtual Fields Using a Multi-Path Data Source

Calculations of a virtual field may include fields from all segments of a data source, but they must lie in a unique top-to-bottom path. Different virtual fields may, of course, lie along different paths. For example, consider the following data source structure:

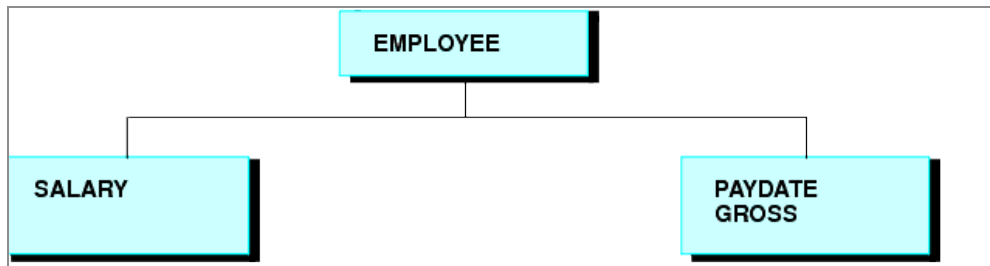

This data source structure does not permit you to write the following expression:

```
NEWAMT = SALARY+GROSS;
```

The expression is invalid because the structure implies that there can be several SALARY segments for a given EMPLOYEE, and it is not clear which SALARY to associate with which GROSS.

To accomplish such an operation, you can use the alternate view option explained in [Improving Report Processing](#).

Increasing the Speed of Calculations in Virtual Fields

Virtual fields are compiled into machine code in order to increase the speed of calculations.

Preserving Virtual Fields Using DEFINE FILE SAVE and RETURN

Occasionally, new code needs to be added to an existing application. When adding code, there is always the possibility of over-writing existing virtual fields by reusing their names inadvertently.

The DEFINE FILE SAVE command forms a new context for virtual fields. Each new context creates a new layer or command environment. When you first enter the new environment, all of the virtual fields defined in the previous layer are available in the new layer. Overwriting or clearing a virtual field definition affects only the current layer. You can return to the default context with the DEFINE FILE RETURN command, and the virtual field definitions remain intact.

Therefore, all the virtual fields that are created in the new application can be removed before returning to the calling application, without affecting existing virtual fields in that application.

For an example of DEFINE FILE SAVE and DEFINE FILE RETURN, see [Joining Data Sources](#).



Note: A JOIN command can be issued after a DEFINE FILE SAVE command. However, in order to clear the join context, you must issue a JOIN CLEAR command if the join is still in effect. If only virtual fields and DEFINE FILE ADD were issued after a DEFINE FILE SAVE command, you can clear them by issuing a DEFINE FILE RETURN command.

Protect Virtual Fields From Being Overwritten

```
DEFINE FILE filename SAVE
fld1/format1=expression1;
fld2/format2=expression2;
END
TABLE FILE filename ...
MODIFY FILE filename ...
DEFINE FILE filename RETURN
END
```

where:

SAVE

Creates a new context for virtual fields.

filename

Is the name of the Master File that gets a new context and has the subsequent virtual fields applied before the DEFINE FILE RETURN command is issued.

RETURN

Clears the current context if it was created by DEFINE FILE SAVE, and restores the previous context.

Applying Dynamically Formatted Virtual Fields to Report Columns

Dynamic formatting enables you to apply different formats to specific data in a column by using a temporary field that contains dynamic data settings.

Before you can format a report column using the dynamic format, you must create the report, then apply the temporary field to a column in the report. For example, you can create a temporary field that contains different decimal currency formats for countries like Japan (which uses no decimal places) and England (which uses 2 decimal places). These currency formats are considered dynamic formats. You can then apply the temporary field containing the dynamic formatting to a Sales column. In a report, the Sales column reflects the different currency formats for each country.

The field that contains the format specifications can be:

- A real field in the data source.
- A temporary field created with a DEFINE command.
- A DEFINE in the Master File.
- A COMPUTE command. If the field is created with a COMPUTE command, the command must appear in the request prior to using the calculated field for reformatting.

The field that contains the formats must be alphanumeric, and at least eight characters in length. Only the first eight characters are used for formatting.

The field-based format may specify a length longer than the length of the original field. However, if the new length is more than one-third larger than the original length, the report column width may not be large enough to hold the value (indicated by asterisks in the field).

You can apply a field-based format to any type of field. However, the new format must be compatible with the original format:

- A numeric field can be reformatted to any other numeric format with any edit format options.
- An alphanumeric field can be reformatted to a different length.
- Any date field can be reformatted to any other date format type.
- Any date-time field can be reformatted to any other date-time format.

If the field-based format is invalid or specifies an impermissible type of conversion, the field displays with plus signs (+++++) on the report output.

Define and Apply a Format Field

- With a DEFINE command:

```
DEFINE FILE filename  
format_field/A8 = expression;  
END
```

- In a Master File:

```
DEFINE format_field/A8 = expression; $
```

- In a request:

```
COMPUTE format_field/A8 = expression;
```

where:

format_field

Is the name of the field that contains the format for each row.

expression

Is the expression that assigns the format values to the format field.

After the format field is defined, you can apply it in a report request:

```
TABLE FILE filename  
display fieldname/format_field[/just]  
END
```

where:

display

Is any valid display command.

fieldname

Is a field in the request to be reformatted.

format_field

Is the name of the field that contains the formats. If the name of the format field is the same as an explicit format, the explicit format is used. For example, a field named I8 cannot be used for field-based reformatting, because it is interpreted as the explicit format I8.

just

Is a justification option: L, R, or C. The justification option can be placed before or after the format field, separated from the format by a slash.

Usage Notes for Field-Based Reformatting

- Field-based reformatting is supported for TABLE and TABLEF. It works with StyleSheets, joins, and any type of data source.
- Field-based reformatting is not supported for MODIFY, Maintain, MATCH, GRAPH, RECAP, FOOTING, HEADING, or text fields.
- Although you can use a DEFINE or COMPUTE command to create the format field, you *cannot* apply a field-based format to a calculated or virtual field.

- Field-based reformatting cannot be used on a BY sort field. It does work with an ACROSS field.
- If a report column is produced using field-based reformatting, the format used for a total or subtotal of the column is taken from the previous detail line.
- Explicit reformatting creates two display fields internally for each field that is reformatted. Field-based reformatting creates three display fields.
- Field-based formats are applied at the final output phase of report processing, while specific formats are applied prior to performing calculations. Therefore, the dynamically reformatted field will perform calculations, including summation, using the original format, while a field reformatted using a specific format will use the new format for calculations. Thus, there may be numeric differences in the final output because of rounding when using packed fields that reduce the precision.
- Field-based reformatting works for alphanumeric fields in a HOLD file, although three fields are stored in the file for each field that is reformatted. To prevent the extra fields from being propagated to the HOLD file, specify SET HOLDLIST=PRINTONLY.
- If the number of decimal places varies between rows, the decimal points are not aligned in the report output.

Creating Dynamically Formatted Fields

The following request formats the DOLLARS2 field according to the value of the CATEGORY field and shows the numeric differences in sums using dynamic and static reformatting:

```
DEFINE FILE GGSALES
MYFORMAT/A8=DECODE CATEGORY ('Coffee' 'P15.3' 'Gifts' 'P15.0' ELSE
'P15.2');
DOLLARS2/P15.2 = DOLLARS + .5;
END
```

```
TABLE FILE GGSALES
SUM DOLLARS2/MYFORMAT AS 'Dynamic' DOLLARS2/P10.2 AS 'Specific'
BY CATEGORY
ON TABLE SUBTOTAL
ON TABLE SET PAGE NOLEAD
ON TABLE SET STYLE *
```

```
GRID=OFF,$
END
```

The output is shown in the following image:

<u>Category</u>	<u>Dynamic</u>	<u>Specific</u>
Coffee	17232175.000	17232175.00
Food	17230053.00	17230053.00
Gifts	11696221.	11696220.50
TOTAL	46158449.	46158448.50

Passing Function Calls Directly to a Relational Engine Using SQL.Function Syntax

The SQL adapters can pass virtual fields that call certain SQL scalar functions to the relational engine for processing. This enables you to use SQL functions in a request even when they have no equivalent in the FOCUS language. The function must be row-based and have a parameter list that consists of a comma-delimited list of column names or constants. In order to reference the function in an expression, prefix the function name with **SQL**.

If the virtual field is in the Master File, both TABLE requests and those SQL requests that qualify for Automatic Passthru (APT) can access the field. If the virtual field is created by a DEFINE FILE command, TABLE requests can access the field. The function name and parameters are passed without translation to the relational engine. Therefore, the expression that creates the DEFINE field must be optimized, or the request will fail.

Usage Notes for Direct SQL Function Calls

- The expression containing the **SQL.function** call must be optimized or the request will fail with the following message:

(FOC32605) NON OPTIMIZABLE EXPRESSION WITH SQL. SYNTAX

- The function must be a row-based scalar function and have a parameter list that consists of a comma-delimited list of column names or constants. If the function uses anything other than a list of comma separated values, the SQL. syntax cannot be used to pass it.
- Constant DEFINE fields must be assigned a segment location using the WITH phrase.
- Expressions should be declared as DEFINE fields, which are supported as parameters to an SQL function.
- Data types are not supported as parameters to an SQL function. Examples of data type arguments are CHAR and INT for the CONVERT function and ISO, EUR, JIS, and USA for the CHAR function.

Calling the SQL COALESCE Function in a Request

The following example creates the table GGORA, which has columns Biscotti, Capuccino, Croissant, Espresso, and Latte, some of which are null. It then issues a TABLE request that calls the SQL function COALESCE. COALESCE returns the first column in the parameter list that does not contain a null value, if one exists.

The Master File for GGORA is:

```
FILENAME=GGORA , SUFFIX=SQLORA , IOTYPE=STREAM, $
SEGMENT=GGORA, SEGTYPE=S0, $
FIELDNAME=CATEGORY, ALIAS=CAT, USAGE=A11, ACTUAL=A11,
MISSING=ON, $
FIELDNAME=Biscotti, ALIAS=BIS, USAGE=I08, ACTUAL=A08,
MISSING=ON, $
FIELDNAME=Capuccino, ALIAS=CAP, USAGE=I08, ACTUAL=A08,
MISSING=ON, $
FIELDNAME=Croissant, ALIAS=CROI, USAGE=I08, ACTUAL=A08,
MISSING=ON, $
FIELDNAME=Espresso, ALIAS=ESP, USAGE=I08, ACTUAL=A08,
MISSING=ON, $
FIELDNAME=Latte, ALIAS=LAT, USAGE=I08, ACTUAL=A08,
MISSING=ON, $
FIELDNAME=Mug, ALIAS=MUG, USAGE=I08, ACTUAL=A08,
MISSING=ON, $
FIELDNAME=Scone, ALIAS=SCO, USAGE=I08, ACTUAL=A08,
```

```
MISSING=ON, $
FIELDNAME=Thermos, ALIAS=THER, USAGE=I08, ACTUAL=A08,
MISSING=ON, $
```

The following procedure creates the table GGORA based on the FOCUS data source GGSALES (with MISSING=ON attributes added to the DOLLARS field in the Master File):

```
APP HOLDMETA baseapp
APP HOLDDATA baseapp
SET HOLDMISS = ON
SET HOLDLIST=PRINTONLY
SET ASNAMES = ON
TABLE FILE GGSALES
SUM DOLLARS AS ''
BY CATEGORY
ACROSS PRODUCT
WHERE PRODUCT NE 'Coffee Grinder' OR 'Coffee Pot'
ON TABLE HOLD AS GGFLAT FORMAT ALPHA
END

FILEDEF GGFLAT DISK baseapp/ggflat.ftm
CREATE FILE GGORA
MODIFY FILE GGORA
FIXFORM FROM GGFLAT
DATA ON GGFLAT
END
```

The following TABLE request calls the SQL function COALESCE:

```
SET TRACEUSER = ON
SET TRACESTAMP = OFF
SET TRACEON = STMTRACE//CLIENT

DEFINE FILE GGORA
VALUE/I8 MISSING ON = SQL.COALESCE(Biscotti, Capuccino, Croissant,
Espresso, Latte);
END
TABLE FILE GGORA
PRINT Biscotti Capuccino Croissant Espresso Latte VALUE
BY CATEGORY
ON TABLE SET PAGE NOPAGE
END
```

The trace output shows that the SQL function call was passed to the RDBMS:

```

SELECT
COALESCE(T1."BIS",T1."CAP",T1."CROI",T1."ESP",T1."LAT"),
T1."CAT",
T1."BIS",
T1."CAP",
T1."CROI",
T1."ESP",
T1."LAT"
FROM
GGORA T1
ORDER BY
T1."CAT";

```

The output is:

CATEGORY	Biscotti	Capuccino	Croissant	Espresso	Latte	VALUE
Coffee	.	2381590	.	3906243	10943622	2381590
Food	5263317	.	7749902	.	.	5263317
Gifts

CATEGORY	Biscotti	Capuccino	Croissant	Espresso	Latte	VALUE
Coffee	.	2381590	.	3906243	10943622	2381590
Food	5263317	.	7749902	.	.	5263317
Gifts

Creating a Calculated Value

A calculated value is a temporary field that is evaluated after all the data that meets the selection criteria is retrieved, sorted, and summed. Calculated values are available only for the specified report request.

You specify the COMPUTE command in the body of the report request, following the display command and optionally introduced by AND. You can compute more than one field with a single COMPUTE command.

Usage Notes for Calculated Field Values

The following apply to the use of calculated values:

- If you specify any optional COMPUTE phrases (such as, AS, IN, or NORPINT), and you compute additional fields following these phrases, you must repeat the commands COMPUTE or AND COMPUTE before specifying the additional fields.
- You can rename and justify column totals and row totals. For information, see the examples in [Including Totals and Subtotals](#).
- Expressions in a COMPUTE command can include fields with prefix operators (see [Manipulating Display Fields With Prefix Operators](#)). For more information on valid expressions, see [Using Expressions](#).
- Fields referred to in a COMPUTE command are counted toward the display field limit, and appear in the internal matrix. For details on determining the maximum number of display fields that can be used in a request, see [Displaying Report Data](#).
- Field names used in the expression that defines the calculated field cannot be enclosed in single or double quotation marks. Any character string enclosed in quotation marks is treated as a literal string, not a field reference.
- When using a COMPUTE with an ACROSS COLUMNS phrase, the COLUMNS should be specified last:

```
ACROSS acrossfield [AND] COMPUTE compute_expression; COLUMNS values
```

Create a Calculated Value

```
COMPUTE fld [/format] [(GEOGRAPHIC_ROLE = georole)] = expression;
  [AS 'title'] [NOPRINT] [IN [+n]]
```

where:

fld

Is the name of the calculated value.

The name can be any name that complies with FOCUS field naming rules.

Do not use field names of the type Cn , En , and Xn (where n is any sequence of one or two digits), because they are reserved for other uses.

format

Is the format of the field. The default is D12.2. For more information on formats, see the *ibi™ FOCUS® Describing Data* manual.

georole

Is a valid geographic role. The following is a list of default geographic roles.

- **ADDRESS_FULL.** Full address.
- **ADDRESS_LINE.** Number and street name.
- **CITY.** City name.
- **CONTINENT.** Continent name.
- **COUNTY.** County name.
- **COUNTRY.** Country name.
- **GEOMETRY_AREA.** Geometry area.
- **GEOMETRY_LINE.** Geometry line.
- **GEOMETRY_POINT.** Geometry point.
- **LATITUDE.** Latitude.
- **LONGITUDE.** Longitude.
- **POSTAL_CODE.** Postal code.
- **STATE.** State name.

expression

Can be an arithmetic and/or logical expression or function (see [Using Expressions](#)). Each field used in the expression must be part of the request. Each expression must end with a semicolon (;).

NOPRINT

Suppresses printing of the field. .

AS 'title'

Changes the name of the calculated value.

IN [+n]

Specifies the location of the column.

Create a Calculated Value Without a Calculation

```
COMPUTE fld [/format]= ;
```

where:

fld

Is the name of the calculated value.

The name can be any name that complies with FOCUS field naming rules.

Do not use field names of the type Cn , En , and Xn (where n is any sequence of one or two digits), because they are reserved for other uses.

format

Is the format of the field. The default is D12.2. For information on formats, see the *ibi™ FOCUS® Describing Data* manual.

Calculating a Field Value

In the following example, the COMPUTE command creates a temporary field REVENUE based on the product of UNIT_SOLD and RETAIL_PRICE, and displays this information for New York City. The format D12.2M indicates the field format for REVENUE and the AS command changes the default column headings for UNIT_SOLD and RETAIL_PRICE. REVENUE is only available for this report request.

```
TABLE FILE SALES
HEADING CENTER
"NEW YORK PROFIT REPORT"
" "
SUM UNIT_SOLD AS 'UNITS,SOLD' RETAIL_PRICE AS 'RETAIL,PRICE'
COMPUTE REVENUE/D12.2M = UNIT_SOLD * RETAIL_PRICE;
BY PROD_CODE AS 'PROD,CODE'
```

```
WHERE CITY EQ 'NEW YORK'
END
```

The output is:

NEW YORK PROFIT REPORT			
PROD CODE	UNITS SOLD	RETAIL PRICE	REVENUE
----	-----	-----	-----
B10	30	\$.85	\$25.50
B17	20	\$1.89	\$37.80
B20	15	\$1.99	\$29.85
C13	15	\$1.99	\$29.85
C14	18	\$2.05	\$36.90
C17	12	\$2.09	\$25.08
D12	20	\$2.09	\$41.80
E1	30	\$.89	\$26.70
E2	33	\$.99	\$32.67
E3	35	\$1.09	\$38.15

Using Positional Column Referencing With Calculated Values

In a COMPUTE command, it is sometimes convenient to refer to a field by its report column position, rather than its name. This option is especially useful when the same field is specified for several report columns.

Column referencing becomes essential when you are using the same field name in a variety of ways. The following image shows that columns produced by display commands (whether displayed or not) can be referred to as C1 for the first column, C2 for the second column, and so forth. The BY field columns are not counted.

For additional information about column reference numbers, see [Assigning Column Reference Numbers](#).

Using Positional Column Referencing

The following example demonstrates positional field references in a COMPUTE command:

```
TABLE FILE CAR
SUM AVE.DEALER_COST
SUM AVE.DEALER_COST AND COMPUTE RATIO=C1/C2;
BY COUNTRY
END
```

The columns produced by display commands can be referred to as C1 for the first column (AVE.DEALER_COST), C2 for the second column (AVE.DEALER_COST BY COUNTRY), and so forth. The BY field columns are not counted.

The output is:

AVE DEALER_COST	COUNTRY	AVE DEALER_COST	RATIO
-----	-----	-----	-----
7,989	ENGLAND	9,463	.84
	FRANCE	4,631	1.73
	ITALY	10,309	.77
	JAPAN	2,756	2.90
	W GERMANY	7,795	1.02

Using ACROSS With Calculated Values

If the COMPUTE command is issued immediately following an ACROSS phrase, only a recap type of the calculation is performed once for all columns. COMPUTE is used as part of a display command, so a new column is calculated for each set of values.

Using COMPUTE as Part of a Display Command

```
TABLE FILE SALES
SUM UNIT_SOLD
COMPUTE NEWVAL = UNIT_SOLD * RETAIL_PRICE;
ACROSS CITY
END
```

The first page of output is:

CITY		NEWARK		STAMFORD		UNIONDALE	
NEW YORK	NEWVAL	UNIT_SOLD	NEWVAL	UNIT_SOLD	NEWVAL	UNIT_SOLD	NEWVAL
162	1,764.18	42	104.16	376	4,805.28	65	297.70

Using ACROSS With Calculated Values

In the following COMPUTE command, C1, C2, C3, C4, C5, and C6 are positional column references, and the COMPUTE command follows the ACROSS phrase. The COMPUTE is performed once for the report, and the results are displayed to the right of all sort groups.

```
TABLE FILE SALES
SUM UNIT_SOLD AND RETURNS
WHERE DATE GE '010' AND DATE LE '1031'
ACROSS DATE
COMPUTE
TOT_UNITS/D5=C1 + C3 + C5;
TOT_RETURNS = C2 + C4 + C6;
END
```

The output is:

DATE					
10/17	10/18	10/19	TOT_UNITS	TOT_RETURNS	
UNIT_SOLD	RETURNS	UNIT_SOLD	RETURNS	UNIT_SOLD	RETURNS
162	15	78	2	29	1
269	18.00				

Sorting Calculated Values

You can sort a report by a virtual field or a calculated value. To sort by a calculated value, you must use the BY TOTAL phrase in your request. For details, see [Sorting and Aggregating Report Columns](#).

Screening on Calculated Values

You can screen on values produced by COMPUTE commands by using the WHERE TOTAL or WHERE_GROUPED test, as described in [Selecting Records for Your Report](#).

Assigning Column Reference Numbers

Column notation assigns a sequential column number to each column in the internal matrix created for a report request. If you want to control the creation of column reference numbers for the columns that are used in your report, use the CNOTATION column notation command.

Because column numbers refer to columns in the internal matrix, they are assigned after retrieval and aggregation of data are completed. Columns created and displayed in a report are stored in the internal matrix, and columns that are not displayed in a report may also be generated and stored in the internal matrix. Columns stored in the internal matrix include calculated values, reformatted field values, BY fields, fields with the NOPRINT option, and certain RECAP calculations such as FORECAST and REGRESS. Every other column in the internal matrix is assigned a column number by default which means you have to account for all internally generated columns if you want to refer to the appropriate column value in your request.

You can change the default assignment of column reference numbers by using the SET CNOTATION command which can assign column numbers only to columns that display in the report output or to all fields referenced in the report request. You can use column notation in COMPUTE and RECAP commands to refer to these columns in your request.

Control the Creation of Column Reference Numbers

```
SET CNOTATION={ALL | PRINTONLY | EXPLICIT}
```

where:

ALL

Assigns column reference numbers to every column in the internal matrix. ALL is the default value.

PRINTONLY

Assigns column reference numbers only to columns that display in the report output.

EXPLICIT

Assigns column reference numbers to all fields referenced in the request, whether displayed or not.

Using Column Notation in a Report Request

To create a column reference in a request, you can:

- Preface the column number with a C in a non-FML request.
- Use the column number as an index in conjunction with a row label in an FML request. With this type of notation, you can specify a specific column, a relative column number, or a sequence or series of columns.
- Refer to a particular cell in an FML request using the notation $E(r,c)$, where r is a row number and c is a column number.

Using Column Notation in a Non-FML Request With CNOTATION=ALL

In the following request with CNOTATION=ALL, the product of C1 and C2 *does not* calculate TRANSTOT times QUANTITY because the reformatting generates additional columns.

```
SET CNOTATION = ALL
TABLE FILE VIDEOTRK
SUM TRANSTOT/D12.2 QUANTITY/D12.2
AND COMPUTE
PRODUCT = C1 * C2;
BY TRANSDATE
END
```

The output is:

TRANSDATE	TRANSTOT	QUANTITY	PRODUCT
-----	-----	-----	-----
91/06/17	57.03	12.00	3,252.42
91/06/18	21.25	2.00	451.56
91/06/19	38.17	5.00	1,456.95
91/06/20	14.23	3.00	202.49
91/06/21	44.72	7.00	1,999.88
91/06/24	126.28	12.00	15,946.63
91/06/25	47.74	8.00	2,279.11
91/06/26	40.97	2.00	1,678.54
91/06/27	60.24	9.00	3,628.85
91/06/28	31.00	3.00	961.00

BY fields do not get a column reference, so the first column reference is for TRANSTOT with its original format, then the reformatted version. Next is QUANTITY with its original format and then the reformatted version. Last is the calculated value, PRODUCT.

Using Column Notation in a Non-FML Request With CNOTATION=PRINTONLY

Setting CNOTATION=PRINTONLY assigns column references to the output columns only. In this case, the product of C1 and C2 *does* calculate TRANSTOT times QUANTITY.

```

SET CNOTATION = PRINTONLY

TABLE FILE VIDEOTRK
SUM TRANSTOT/D12.2 QUANTITY/D12.2
AND COMPUTE
PRODUCT = C1 * C2;
BY TRANSDATE
END

```

The output is:

TRANSDATE	TRANSTOT	QUANTITY	PRODUCT
-----	-----	-----	-----
91/06/17	57.03	12.00	684.36
91/06/18	21.25	2.00	42.50
91/06/19	38.17	5.00	190.85
91/06/20	14.23	3.00	42.69
91/06/21	44.72	7.00	313.04
91/06/24	126.28	12.00	1,515.36
91/06/25	47.74	8.00	381.92
91/06/26	40.97	2.00	81.94
91/06/27	60.24	9.00	542.16
91/06/28	31.00	3.00	93.00

Using CNOTATION=PRINTONLY With Column Numbers in an FML Request

In the following request, the reformatting of fields generates additional columns in the internal matrix. In the second RECAP expression, note that because of the CNOTATION setting:

- TOTCASH(1) refers to total cash in displayed column 1.
- TOTCASH(2) refers to total cash in displayed column 2.
- The resulting calculation is displayed in column 2 of the row labeled CASH GROWTH (%).
- The RECAP value is only calculated for the column specified.

```

SET CNOTATION=PRINTONLY
DEFINE FILE LEDGER
CUR_YR/I5C=AMOUNT;
LAST_YR/I5C=.87*CUR_YR - 142;
END
TABLE FILE LEDGER
SUM CUR_YR/F9.2 AS 'CURRENT, YEAR'
LAST_YR/F9.2 AS 'LAST, YEAR'

FOR ACCOUNT
1010 AS 'CASH ON HAND' OVER
1020 AS 'DEMAND DEPOSITS' OVER
1030 AS 'TIME DEPOSITS' OVER
BAR OVER
RECAP TOTCASH/F9.2C= R1 + R2 + R3; AS 'TOTAL CASH' OVER
" " OVER
RECAP GROCASH(2)/F9.2C=100*TOTCASH(1)/TOTCASH(2) - 100;
AS 'CASH GROWTH(%)'
END

```

The output is:

	CURRENT YEAR -----	LAST YEAR ----
CASH ON HAND	8784.00	7214.00
DEMAND DEPOSITS	4494.00	3482.00
TIME DEPOSITS	7961.00	6499.00
	-----	-----
TOTAL CASH	21,239.00	17,195.00
CASH GROWTH(%)		23.52

Using CNOTATION=PRINTONLY to RECAP Over Contiguous Columns in an FML Request

In this example, the RECAP calculation for ATOT occurs only for displayed columns 2 and 3, as specified in the request. No calculation is performed for displayed column 1.

```

SET CNOTATION=PRINTONLY
DEFINE FILE LEDGER

```

```

CUR_YR/I5C=AMOUNT;
LAST_YR/I5C=.87*CUR_YR - 142;
NEXT_YR/I5C=1.13*CUR_YR + 222;
END
TABLE FILE LEDGER
SUM NEXT_YR/F9.2 CUR_YR/F9.2 LAST_YR/F9.2
FOR ACCOUNT
10$$ AS 'CASH'                                OVER
1100 AS 'ACCOUNTS RECEIVABLE'                OVER
1200 AS 'INVENTORY'                          OVER
BAR                                            OVER
RECAP ATOT(2,3)/I5C = R1 + R2 + R3;
AS 'ASSETS ACTUAL'
END

```

The output is:

	NEXT_YR	CUR_YR	LAST_YR
	-----	-----	-----
CASH	25991.00	21239.00	17195.00
ACCOUNTS RECEIVABLE	21941.00	18829.00	15954.00
INVENTORY	31522.00	27307.00	23329.00
	-----	-----	-----
ASSETS ACTUAL		67,375	56,478

Using CNOTATION=PRINTONLY With Relative Column Addressing in an FML Request

This example computes the change in cash (CHGCASH) for displayed columns 1 and 2.

```

SET CNOTATION=PRINTONLY
DEFINE FILE LEDGER
CUR_YR/I5C=AMOUNT;
LAST_YR/I5C=.87*CUR_YR - 142;
NEXT_YR/I5C=1.13*CUR_YR + 222;
END
TABLE FILE LEDGER
SUM NEXT_YR/F9.2 CUR_YR/F9.2 LAST_YR/F9.2
FOR ACCOUNT
10$$ AS 'TOTAL CASH' LABEL TOTCASH                OVER
" "                                             OVER

```

```

RECAP CHGCASH(1,2)/I5C = TOTCASH(*) - TOTCASH(*+1); AS 'CHANGE IN CASH'
END

```

The output is:

	NEXT_YR	CUR_YR	LAST_YR
	-----	-----	-----
TOTAL CASH	25991.00	21239.00	17195.00
CHANGE IN CASH	4,752	4,044	

Using CNOTATION=PRINTONLY With Cell Notation in an FML Request

In this request, two RECAP expressions derive VARIANCES (EVAR and WVAR) by subtracting values in four displayed columns (1, 2, 3, 4) in row three (PROFIT); these values are identified using cell notation (r,c).

```

SET CNOTATION=PRINTONLY
TABLE FILE REGION
SUM E_ACTUAL/F9.2 E_BUDGET/F9.2 W_ACTUAL/F9.2 W_BUDGET/F9.2
FOR ACCOUNT
3000 AS 'SALES'                                OVER
3100 AS 'COST'                                  OVER
BAR                                              OVER
RECAP PROFIT/I5C = R1 - R2;                     OVER
" "                                             OVER
RECAP EVAR(1)/I5C = E(3,1) - E(3,2);           OVER
AS 'EAST VARIANCE'
RECAP WVAR(3)/I5C = E(3,3) - E(3,4);           OVER
AS 'WEST VARIANCE'
END

```

The output is:

	E_ACTUAL	E_BUDGET	W_ACTUAL	W_BUDGET
	-----	-----	-----	-----
SALES	6000.00	4934.00	7222.00	7056.00
COST	4650.00	3760.00	5697.00	5410.00
	-----	-----	-----	-----

PROFIT		1,350	1,174	1,525	1,646
EAST VARIANCE		176			
WEST VARIANCE				-121	

	<u>E</u>	<u>ACTUAL</u>	<u>E</u>	<u>BUDGET</u>	<u>W</u>	<u>ACTUAL</u>	<u>W</u>	<u>BUDGET</u>
SALES		6000.00		4934.00		7222.00		7056.00
COST		4650.00		3760.00		5697.00		5410.00
PROFIT		1,350		1,174		1,525		1,646
EAST VARIANCE		176						
WEST VARIANCE						-121		

Using NOPRINT, Field Reformatting, and COMPUTE With Column Notation

The following request has a field that is not printed, several reformatted fields and three calculated values. With SET CNOTATION=PRINTEONLY, the column references result in correct output.

```

SET CNOTATION = PRINTEONLY
DEFINE FILE LEDGER
CUR_YR/I5C=AMOUNT;
LAST_YR/I5C=.87*CUR_YR - 142;
NEXT_YR/I5C=1.13*CUR_YR + 222;
END
TABLE FILE LEDGER
SUM NEXT_YR NOPRINT CUR_YR
COMPUTE AMT2/D6 = AMOUNT *2;
LAST_YR/D5 AMOUNT NEXT_YR
COMPUTE AMT3/D6 = AMOUNT*3;
COMPUTE AMT4/D6 = AMOUNT*4;
FOR ACCOUNT
10$$ AS 'CASH' OVER
1100 AS 'ACCTS. REC.' OVER
1200 AS 'INVENTORY' OVER
BAR OVER
RECAP ATOT/I8C = R1 + R2 + R3; AS 'TOTAL' OVER

```

```
RECAP DIFF(2,10,2)/D8 = ATOT(*) - ATOT(*-1);
END
```

The output is:

	CUR_YR	AMT2	LAST_YR	AMOUNT	NEXT_YR	AMT3	AMT4
	-----	----	-----	-----	-----	----	----
CASH	21,239	42,478	17,195	21,239	25,991	63,717	84,956
ACCTS. REC.	18,829	37,658	15,954	18,829	21,941	56,487	75,316
INVENTORY	27,307	54,614	23,329	27,307	31,522	81,921	109,228
	-----	-----	-----	-----	-----	-----	-----
TOTAL	67,375	134,750	56,478	67,375	79,454	202,125	269,500
DIFF		67,375		10,897		122,671	

	<u>CUR_YR</u>	<u>AMT2</u>	<u>LAST_YR</u>	<u>AMOUNT</u>	<u>NEXT_YR</u>	<u>AMT3</u>	<u>AMT4</u>
CASH	21,239	42,478	17,198	21,239	25,992	63,717	84,956
ACCTS. REC.	18,829	37,658	15,954	18,829	21,941	56,487	75,316
INVENTORY	27,307	54,614	23,329	27,307	31,522	81,921	109,228
	-----	-----	-----	-----	-----	-----	-----
TOTAL	67,375	134,750	56,481	67,375	79,455	202,125	269,500
DIFF		67,375		10,894		122,670	

Using Column Notation With NOPRINT in a non-FML Request

The following request, sums TRANSTOT, QUANTITY, and TRANSCODE by TRANSDATE. TRANSTOT has the NOPRINT option, so it is not displayed on the report output. The request also calculates the following fields using COMPUTE commands:

- TTOT2, which has the same value as TRANSTOT and displays on the report output.
- UNIT_COST1, which is calculated by dividing column1 by column2.
- UNIT_COST2, which is calculated by dividing column1 by QUANTITY.

```
SET CNOTATION = ALL
TABLE FILE VIDEOTRK
SUM TRANSTOT/D7.2 NOPRINT QUANTITY/D7.2 TRANSCODE
  COMPUTE TTOT2/D7.2 = C1;
  COMPUTE UNIT_COST1/D7.2 = C1/C2;
```

```

COMPUTE UNIT_COST2/D7.2 = C1/QUANTITY;
BY TRANSDATE
END

```

With this request, only CNOTATION=EXPLICIT produces the correct output. The following discussion illustrates why the EXPLICIT setting is needed.

With CNOTATION=ALL, all fields in the internal matrix are assigned column numbers. In particular, the request creates the following column references:

- C1 is TRANSTOT with its original format.
- C2 is TRANSTOT with format D7.2.
- C3 is QUANTITY with its original format.
- C4 is QUANTITY with format D7.2.
- C5 is TRANSCODE.

UNIT_COST1 is C1/C2. These column numbers have both been assigned to TRANSTOT, so UNIT_COST1 always equals 1. UNIT_COST2 is C1 (TRANSTOT) divided by QUANTITY. The output is:

TRANSDATE	QUANTITY	TRANSCODE	TTOT2	UNIT_COST1	UNIT_COST2
-----	-----	-----	-----	-----	-----
91/06/17	12.00	10	57.03	1.00	4.75
91/06/18	2.00	2	21.25	1.00	10.63
91/06/19	5.00	4	38.17	1.00	7.63
91/06/20	3.00	3	14.23	1.00	4.74
91/06/21	7.00	6	44.72	1.00	6.39
91/06/24	12.00	9	126.28	1.00	10.52
91/06/25	8.00	7	47.74	1.00	5.97
91/06/26	2.00	2	40.97	1.00	20.48
91/06/27	9.00	7	60.24	1.00	6.69
91/06/28	3.00	3	31.00	1.00	10.33

With CNOTATION = PRINTONLY, the field TRANSTOT, which has the NOPRINT option, is not assigned any column numbers. QUANTITY with its original format is not assigned a column number because it is not displayed on the report output. The reformatted QUANTITY field is displayed and is assigned a column number. Therefore, the request creates the following column references:

- C1 is QUANTITY with format D7.2.

- C2 is TRANSCODE.

UNIT_COST1 is C1/C2, QUANTITY/TRANSCODE. UNIT_COST2 is C1 (QUANTITY) divided by QUANTITY. Therefore, UNIT_COST2 always equals 1. The output is:

TRANSDATE	QUANTITY	TRANSCODE	TTOT2	UNIT_COST1	UNIT_COST2
91/06/17	12.00	10	12.00	1.20	1.00
91/06/18	2.00	2	2.00	1.00	1.00
91/06/19	5.00	4	5.00	1.25	1.00
91/06/20	3.00	3	3.00	1.00	1.00
91/06/21	7.00	6	7.00	1.17	1.00
91/06/24	12.00	9	12.00	1.33	1.00
91/06/25	8.00	7	8.00	1.14	1.00
91/06/26	2.00	2	2.00	1.00	1.00
91/06/27	9.00	7	9.00	1.29	1.00
91/06/28	3.00	3	3.00	1.00	1.00

With CNOTATION = EXPLICIT, the reformatted TRANSTOT field is explicitly referenced in the request, so it is assigned a column number even though it is not displayed. However, the TRANSTOT field with its original format is not assigned a column number. The QUANTITY field with its original format is not assigned a column number because it is not explicitly referenced in the request. The reformatted QUANTITY field is assigned a column number. Therefore, the request creates the following column references:

- C1 is TRANSTOT with format D7.2.
- C2 is QUANTITY with format D7.2.
- C3 is TRANSCODE.

UNIT_COST1 is C1/C2, TRANSTOT/QUANTITY. UNIT_COST2 is C1 (TRANSTOT) divided by QUANTITY. Therefore, UNIT_COST2 always equals UNIT_COST1. The output is:

TRANSDATE	QUANTITY	TRANSCODE	TTOT2	UNIT_COST1	UNIT_COST2
91/06/17	12.00	10	57.03	4.75	4.75
91/06/18	2.00	2	21.25	10.63	10.63
91/06/19	5.00	4	38.17	7.63	7.63
91/06/20	3.00	3	14.23	4.74	4.74
91/06/21	7.00	6	44.72	6.39	6.39
91/06/24	12.00	9	126.28	10.52	10.52
91/06/25	8.00	7	47.74	5.97	5.97
91/06/26	2.00	2	40.97	20.48	20.48

91/06/27	9.00	7	60.24	6.69	6.69
91/06/28	3.00	3	31.00	10.33	10.33

Using Cell Notation in an FML Request

In the following request, CUR_YR has the NOPRINT option. The CHGCASH RECAP expression is supposed to subtract CUR_YR from LAST_YR and NEXT_YR.

```

SET CNOTATION = ALL
DEFINE FILE LEDGER
CUR_YR/I7C = AMOUNT;
LAST_YR/I5C = .87*CUR_YR - 142;
NEXT_YR/I5C = 1.13*CUR_YR + 222;
END
TABLE FILE LEDGER
SUM CUR_YR/I5C NOPRINT LAST_YR NEXT_YR
FOR ACCOUNT
10$$ AS 'TOTAL CASH ' LABEL TOTCASH OVER
" " OVER
RECAP CHGCASH(1,3)/I5SC=(TOTCASH(*) - TOTCASH(1));
  AS 'CHANGE FROM CURRENT'
END

```

When CNOTATION = ALL, C1 refers to the CUR_YR field with its original format, C2 refers to the reformatted value, C3 is LAST_YR, and C4 is NEXT_YR. Since there is an extra column and the RECAP only refers to columns 1 and 3, the calculation for NEXT_YR - CUR_YR is not performed. The output is:

	LAST_YR	NEXT_YR
	-----	-----
TOTAL CASH	17,195	25,991
CHANGE FROM CURRENT	-4,044	

When CNOTATION = PRINTONLY, the CUR_YR field is not assigned any column number, so there is no column 3. Therefore, no calculations are performed. The output is:

	LAST_YR	NEXT_YR
	-----	-----
TOTAL CASH	17,195	25,991

```
CHANGE FROM CURRENT
```

When CNOTATION = EXPLICIT, the reformatted version of the CUR_YR field is C1 because it is referenced in the request even though it is not displayed. Both calculations are performed correctly. The output is:

	LAST_YR	NEXT_YR
	-----	-----
TOTAL CASH	17,195	25,991
CHANGE FROM CURRENT	-4,044	4,752

Usage Notes for Column Numbers

- BY fields are not assigned column numbers.
- ACROSS columns are assigned column numbers.
- Calculated fields are assigned column numbers.
- Column numbers outside the range of the columns created in the request are allowed under the following circumstances (and are treated as containing the value zero):
 - When specified in a COMPUTE command issued after an ACROSS phrase.
 - In a cell reference in an FML RECAP command.

In those cases, it is not possible to know in advance how many columns will be generated by the syntax. Using a column number outside of the range in any other context generates the following message:

```
(FOC258) FIELDNAME OR COMPUTATIONAL ELEMENT NOT RECOGNIZED: column
```

Using FORECAST in a COMPUTE Command

A version of the FORECAST feature was implemented for use in a RECAP command. However, the use of RECAP imposes limitations on placement of the FORECAST field in the

output and use of sort fields.

Using FORECAST in a COMPUTE command eliminates these limitations and enables you to place the FORECAST calculation in a Master File. For the COMPUTE version of FORECAST, each type of calculation has its own version of the FORECAST function.

Calculating Trends and Predicting Values With FORECAST

You can calculate trends in numeric data and predict values beyond the range of those stored in the data source by using the FORECAST feature. FORECAST can be used in a report or graph request.

The calculations you can make to identify trends and forecast values are:

- **Simple moving average (FORECAST_MOVAVE).** Calculates a series of arithmetic means using a specified number of values from a field. For details, see [Using FORECAST in a COMPUTE Command](#).
- **Exponential moving average.** Calculates a weighted average between the previously calculated value of the average and the next data point. There are three methods for using an exponential moving average:
 - **Single exponential smoothing (FORECAST_EXPAVE).** Calculates an average that allows you to choose weights to apply to newer and older values. For details, see [Using FORECAST in a COMPUTE Command](#).
 - **Double exponential smoothing (FORECAST_DOUBLEXP).** Accounts for the tendency of data to either increase or decrease over time without repeating. For details, see [Using FORECAST in a COMPUTE Command](#).
 - **Triple exponential smoothing (FORECAST_SEASONAL).** Accounts for the tendency of data to repeat itself in intervals over time. For details, see [Using FORECAST in a COMPUTE Command](#).
- **Linear regression analysis (FORECAST_LINEAR).** Derives the coefficients of a straight line that best fits the data points and uses this linear equation to estimate values. For details, see [Using FORECAST in a COMPUTE Command](#).

When predicting values in addition to calculating trends, FORECAST continues the same calculations beyond the data points by using the generated trend values as new data

points. For the linear regression technique, the calculated regression equation is used to derive trend and predicted values.

FORECAST performs the calculations based on the data provided, but decisions about their use and reliability are the responsibility of the user. Therefore, the user is responsible for determining the reliability of the FORECAST predictions, based on the many factors that determine how accurate a prediction will be.

FORECAST Processing

You invoke FORECAST processing by including one of the FORECAST functions in a COMPUTE command. FORECAST performs the specified calculation for all the existing data points and then continues them to generate the number of predicted values that you request. The parameters needed for FORECAST include the field to use in the calculations, the number of predictions to generate, and whether to display the input field values or the calculated values on the report output for the rows that represent existing data points.

FORECAST operates on the lowest sort field in the request. This is either the last ACROSS field in the request or, if the request does not contain an ACROSS field, it is the last BY field. The FORECAST calculations start over when the highest-level sort field changes its value. In a request with multiple display commands, FORECAST operates on the last ACROSS field (or if there are no ACROSS fields, the last BY field) of the last display command. When using an ACROSS field with FORECAST, the display command must be SUM or COUNT.

Usage Notes for FORECAST

- The sort field used for FORECAST must be in a numeric or date format.
- When using simple moving average and exponential moving average methods, data values should be spaced evenly in order to get meaningful results.
- The use of column notation is not supported in the FORECAST expression. Column notation continues to be supported as before outside of this expression. The process of generating the FORECAST values creates extra columns that are not printed in the report output. The number and placement of these additional columns varies depending on the specific request.

- Missing values may lead to unexpected or unusable results and are not recommended for use with FORECAST_LINEAR.
- If you use the ESTRECORDS parameter to enable the external sort to better estimate the amount of sort work space needed, you must take into account that FORECAST with predictions creates additional records in the output.
- In a styled report, you can assign specific attributes to values predicted by FORECAST with the StyleSheet attribute WHEN=FORECAST. For example, to make the predicted values display with the color red, use the following syntax in the TABLE request:

```
ON TABLE SET STYLE *
TYPE=DATA,COLUMN=MYFORECASTSORTFIELD,WHEN=FORECAST,COLOR=RED,$
ENDSTYLE
```

FORECAST Limits

The following are not supported with a COMPUTE command that uses FORECAST:

- BY TOTAL command.
- MORE, MATCH, FOR, and OVER phrases.

Distinguishing Data Rows From Predicted Rows

To make the report output easier to interpret, you can create a field that indicates whether the FORECAST value in each row is a predicted value. To do this, define a virtual field whose value is a constant other than zero. Rows in the report output that represent actual records in the data source will appear with a value that is not zero. Rows that represent predicted values will display zero. You can also propagate this field to a HOLD file.

Distinguishing Data Rows From Predicted Rows

In the following example, the DATA_ROW virtual field has the value 1 for each row in the data source. It has the value zero for the predicted rows. The PREDICT field is calculated as YES for predicted rows, and NO for rows containing data. In addition, the StyleSheet

attribute WHEN=FORECAST is used to display the predicted values for the FORTOT field in red.

```

DEFINE FILE VIDEOTRK
DATA_ROW/I1 = 1;
END
TABLE FILE VIDEOTRK
SUM TRANSTOT DATA_ROW
COMPUTE
PREDICT/A3 = IF DATA_ROW NE 0 THEN 'NO' ELSE 'YES' ;
FORTOT/D12.2=FORECAST_LINEAR(MODEL_DATA,TRANSTOT,1,3);
BY TRANSDATE
ON TABLE SET PAGE NOLEAD
ON TABLE SET STYLE *
GRID=OFF,$
TYPE=DATA, COLUMN=FORTOT, WHEN=FORECAST, COLOR=RED,$
ENDSTYLE
END

```

The output is shown in the following image:

<u>TRANSDATE</u>	<u>TRANSTOT</u>	<u>DATA ROW</u>	<u>PREDICT</u>	<u>FORTOT</u>
06/17/91	57.03	10	NO	38.58
06/18/91	21.25	2	NO	40.32
06/19/91	38.17	4	NO	42.07
06/20/91	14.23	3	NO	43.81
06/21/91	44.72	6	NO	45.55
06/24/91	126.28	9	NO	50.78
06/25/91	47.74	7	NO	52.52
06/26/91	40.97	2	NO	54.26
06/27/91	60.24	7	NO	56.00
06/28/91	31.00	3	NO	57.74
06/29/91		0	YES	59.48
06/30/91		0	YES	61.23
07/01/91		0	YES	62.97

Calculating Trends and Predicting Values With FORECAST

You can calculate trends in numeric data and predict values beyond the range of those stored in the data source by using the FORECAST feature. FORECAST can be used in a report or graph request.

The calculations you can make to identify trends and forecast values are:

- **Simple moving average (MOVAVE)**. Calculates a series of arithmetic means using a specified number of values from a field. For details, see [Using a Simple Moving Average](#).
- **Exponential moving average**. Calculates a weighted average between the previously calculated value of the average and the next data point. There are three methods for using an exponential moving average:
 - **Single exponential smoothing (EXPAVE)**. Calculates an average that allows you to choose weights to apply to newer and older values. For details, see [Using Single Exponential Smoothing](#).
 - **Double exponential smoothing (DOUBLEXP)**. Accounts for the tendency of data to either increase or decrease over time without repeating. For details, see [Using Double Exponential Smoothing](#).
 - **Triple exponential smoothing (SEASONAL)**. Accounts for the tendency of data to repeat itself in intervals over time. For details, see [Using Triple Exponential Smoothing](#).
- **Linear regression analysis (REGRESS)**. Derives the coefficients of a straight line that best fits the data points and uses this linear equation to estimate values. For details, see [Usage Notes for Creating Virtual Fields](#).

When predicting values in addition to calculating trends, FORECAST continues the same calculations beyond the data points by using the generated trend values as new data points. For the linear regression technique, the calculated regression equation is used to derive trend and predicted values.

FORECAST performs the calculations based on the data provided, but decisions about their use and reliability are the responsibility of the user. Therefore, FORECAST predictions are not always reliable, and many factors determine how accurate a prediction will be.

FORECAST Processing

You invoke FORECAST processing by including FORECAST in a RECAP command. In this command, you specify the parameters needed for generating estimated values, including the field to use in the calculations, the type of calculation to use, and the number of predictions to generate. The RECAP field that contains the result of FORECAST can be a new field (non-recursive) or the same field used in the FORECAST calculations (recursive):

- In a recursive FORECAST, the RECAP field that contains the results is also the field used to generate the FORECAST calculations. In this case, the original field is not printed even if it was referenced in the display command, and the RECAP column contains the original field values followed by the number of predicted values specified in the FORECAST syntax. No trend values display in the report. However, the original column is stored in an output file unless you set HOLDLIST to PRINTONLY.
- In a non-recursive FORECAST, a new field contains the results of FORECAST calculations. The new field is displayed in the report along with the original field when it is referenced in the display command. The new field contains trend values and forecast values when specified.

FORECAST operates on the last ACROSS field in the request. If the request does not contain an ACROSS field, it operates on the last BY field. The FORECAST calculations start over when the highest-level sort field changes its value. In a request with multiple display commands, FORECAST operates on the last ACROSS field (or if there are no ACROSS fields, the last BY field) of the last display command. When using an ACROSS field with FORECAST, the display command must be SUM or COUNT.

i Note: Although you pass parameters to FORECAST using an argument list in parentheses, FORECAST is not a function. It can coexist with a function of the same name, as long as the function is not specified in a RECAP command.

Calculate Trends and Predict Values

MOVAVE calculation

```
ON sortfield RECAP result_field[/fmt] = FORECAST(infield, interval,
npredict, 'MOVAVE',npoint1)sendstyle
```

EXPAVE calculation

```
ON sortfield RECAP result_field[/fmt] = FORECAST(infield, interval,
  npredict, 'EXPAVE',npoint1);
```

DOUBLEXP calculation

```
ON sortfield RECAP fld1[/fmt] = FORECAST(infield,
  interval, npredict, 'DOUBLEXP',npoint1, npoint2);
```

SEASONAL calculation

```
ON sortfield RECAP fld1[/fmt] = FORECAST(infield,
  interval, npredict, 'SEASONAL', nperiod, npoint1, npoint2, npoint3);
```

REGRESS calculation

```
ON sortfield RECAP result_field[/fmt] = FORECAST(infield, interval,
  npredict, 'REGRESS');
```

where:

sortfield

Is the last ACROSS field in the request. This field must be in numeric or date format. If the request does not contain an ACROSS field, FORECAST works on the last BY field.

result_field

Is the field containing the result of FORECAST. It can be a new field, or the same as *infield*. This must be a numeric field; either a real field, a virtual field, or a calculated field.

 **Note:** The word FORECAST and the opening parenthesis must be on the same line as the syntax *sortfield=*.

fmt

Is the display format for *result_field*. The default format is D12.2. If *result_field* was previously reformatted using a DEFINE or COMPUTE command, the format specified in the RECAP command is respected.

infield

Is any numeric field. It can be the same field as *result_field*, or a different field. It cannot be a date-time field or a numeric field with date display options.

interval

Is the increment to add to each *sortfield* value (after the last data point) to create the next value. This must be a positive integer. To sort in descending order, use the BY HIGHEST phrase. The result of adding this number to the *sortfield* values is converted to the same format as *sortfield*.

For date fields, the minimal component in the format determines how the number is interpreted. For example, if the format is YMD, MDY, or DMY, an interval value of 2 is interpreted as meaning two days; if the format is YM, the 2 is interpreted as meaning two months.

npredict

Is the number of predictions for FORECAST to calculate. It must be an integer greater than or equal to zero. Zero indicates that you do not want predictions, and is only supported with a non-recursive FORECAST. For the SEASONAL method, npredict is the number of *periods* to calculate. The number of *points* generated is:

$$\text{nperiod} * \text{npredict}$$

nperiod

For the SEASONAL method, is a positive whole number that specifies the number of data points in a period.

npoint1

Is the number of values to average for the MOVAVE method. For EXPAVE, DOUBLEXP, and SEASONAL, this number is used to calculate the weights for each component in the average. This value must be a positive whole number. The weight, *k*, is calculated by the following formula:

$$k=2/(1+\text{npoint1})$$

npoint2

For DOUBLEXP and SEASONAL, this positive whole number is used to calculate the weights for each term in the trend. The weight, g , is calculated by the following formula:

$$g=2/(1+npoint2)$$

npoint3

For SEASONAL, this positive whole number is used to calculate the weights for each term in the seasonal adjustment. The weight, p , is calculated by the following formula:

$$p=2/(1+npoint3)$$

Usage Notes for FORECAST

- The sort field used for FORECAST must be in a numeric or date format.
- When using simple moving average and exponential moving average methods, data values should be spaced evenly in order to get meaningful results.
- When using a RECAP command with FORECAST, the command can contain only the FORECAST syntax. FORECAST does not recognize any syntax after the closing semicolon (;). To specify options such as AS or IN:
 - In a non-recursive FORECAST request, use an empty COMPUTE command prior to the RECAP.
 - In a recursive FORECAST request, specify the options when the field is first referenced in the report request.
- The use of column notation is not supported in a request that includes FORECAST. The process of generating the FORECAST values creates extra columns that are not printed in the report output. The number and placement of these additional columns varies depending on the specific request.
- A request can contain up to seven non-FORECAST RECAP commands and up to seven additional FORECAST RECAP commands.
- The left side of a RECAP command used for FORECAST supports the CURR attribute for creating a currency-denominated field.

- Recursive and non-recursive REGRESS are not supported in the same request when the display command is SUM, ADD, or WRITE.
- Missing values are not supported with REGRESS.
- If you use the ESTRECORDS parameter to enable the external sort to estimate better the amount of sort work space needed, you must take into account that FORECAST with predictions creates additional records in the output.
- In a styled report, you can assign specific attributes to values predicted by FORECAST with the StyleSheet attribute WHEN=FORECAST. For example, to make the predicted values display with the color red, use the following syntax in the TABLE request:

```
ON TABLE SET STYLE  
*TYPE=DATA,COLUMN=MYFORECASTSORTFIELD,WHEN=FORECAST,COLOR=RED,  
$ENDSTYLE
```

FORECAST Limits

The following are not supported with a RECAP command that uses FORECAST:

- BY TOTAL command.
- MORE, MATCH, FOR, and OVER phrases.
- SUMMARIZE and RECOMPUTE are not supported for the same sort field used for FORECAST.
- MISSING attribute.

Using a Simple Moving Average

A simple moving average is a series of arithmetic means calculated with a specified number of values from a field. Each new mean in the series is calculated by dropping the first value used in the prior calculation, and adding the next data value to the calculation.

Simple moving averages are sometimes used to analyze trends in stock prices over time. In this scenario, the average is calculated using a specified number of periods of stock prices. A disadvantage to this indicator is that because it drops the oldest values from the

calculation as it moves on, it loses its memory over time. Also, mean values are distorted by extreme highs and lows, since this method gives equal weight to each point.

Predicted values beyond the range of the data values are calculated using a moving average that treats the calculated trend values as new data points.

The first complete moving average occurs at the n^{th} data point because the calculation requires n values. This is called the lag. The moving average values for the lag rows are calculated as follows: the first value in the moving average column is equal to the first data value, the second value in the moving average column is the average of the first two data values, and so on until the n^{th} row, at which point there are enough values to calculate the moving average with the number of values specified.

Calculating a New Simple Moving Average Column

This request defines an integer value named PERIOD to use as the independent variable for the moving average. It predicts three periods of values beyond the range of the retrieved data.

```
DEFINE FILE GGSales
  SDATE/YYM = DATE;
  SYEAR/Y = SDATE;
  SMONTH/M = SDATE;
  PERIOD/I2 = SMONTH;
END
TABLE FILE GGSales
  SUM UNITS DOLLARS
  BY CATEGORY BY PERIOD
  WHERE SYEAR EQ 97 AND CATEGORY NE 'Gifts'
  ON PERIOD RECAP MOVAVE/D10.1= FORECAST(DOLLARS,1,3,'MOVAVE',3);
END
```

The output is:

Category	PERIOD	Unit Sales	Dollar Sales	EXPAVE
Coffee	1	61666	801123	801,123.0
	2	54870	682340	741,731.5
	3	61608	765078	753,404.8
	4	57050	691274	722,339.4
	5	59229	720444	721,391.7
	6	58466	742457	731,924.3

	7	60771	747253	739,588.7
	8	54633	655896	697,742.3
	9	57829	730317	714,029.7
	10	57012	724412	719,220.8
	11	51110	620264	669,742.4
	12	58981	762328	716,035.2
	13	0	0	739,181.6
	14	0	0	750,754.8
	15	0	0	756,541.4
Food	1	54394	672727	672,727.0
	2	54894	699073	685,900.0
	3	52713	642802	664,351.0
	4	58026	718514	691,432.5
	5	53289	660740	676,086.3
	6	58742	734705	705,395.6
	7	60127	760586	732,990.8
	8	55622	695235	714,112.9
	9	55787	683140	698,626.5
	10	57340	713768	706,197.2
	11	57459	710138	708,167.6
	12	57290	705315	706,741.3
	13	0	0	706,028.2
	14	0	0	705,671.6
	15	0	0	705,493.3

In the report, the number of values to use in the average is 3 and there are no UNITS or DOLLARS values for the generated PERIOD values.

Each average (MOVAVE value) is computed using DOLLARS values where they exist. The calculation of the moving average begins in the following way:

- The first MOVAVE value (801,123.0) is equal to the first DOLLARS value.
- The second MOVAVE value (741,731.5) is the mean of DOLLARS values one and two: $(801,123 + 682,340) / 2$.
- The third MOVAVE value (749,513.7) is the mean of DOLLARS values one through three: $(801,123 + 682,340 + 765,078) / 3$.
- The fourth MOVAVE value (712,897.3) is the mean of DOLLARS values two through four: $(682,340 + 765,078 + 691,274) / 3$.

For predicted values beyond the supplied values, the calculated MOVAVE values are used as new data points to continue the moving average. The predicted MOVAVE values (starting with 694,975.6 for PERIOD 13) are calculated using the previous MOVAVE values as new data points. For example, the first predicted value (694,975.6) is the average of the data

points from periods 11 and 12 (620,264 and 762,328) and the moving average for period 12 (702,334.7). The calculation is: $694,975 = (620,264 + 762,328 + 702,334.7)/3$.

Using an Existing Field as a Simple Moving Average Column

This request defines an integer value named PERIOD to use as the independent variable for the moving average. It predicts three periods of values beyond the range of the retrieved data. It uses the same name for the RECAP field as the first argument in the FORECAST parameter list. The trend values do not display in the report. The actual data values for DOLLARS are followed by the predicted values in the report column.

```
DEFINE FILE GGSales
  SDATE/YYM = DATE;
  SYEAR/Y = SDATE;
  SMONTH/M = SDATE;
  PERIOD/I2 = SMONTH;
END
TABLE FILE GGSales
  SUM UNITS DOLLARS
  BY CATEGORY BY PERIOD
  WHERE SYEAR EQ 97 AND CATEGORY NE 'Gifts'
  ON PERIOD RECAP DOLLARS/D10.1 = FORECAST(DOLLARS,1,3,'MOVAVE',3);
END
```

The output is:

Category	PERIOD	Unit Sales	DOLLARS
-----	-----	-----	-----
Coffee	1	61666	801,123.0
	2	54870	682,340.0
	3	61608	765,078.0
	4	57050	691,274.0
	5	59229	720,444.0
	6	58466	742,457.0
	7	60771	747,253.0
	8	54633	655,896.0
	9	57829	730,317.0
	10	57012	724,412.0
	11	51110	620,264.0
	12	58981	762,328.0
	13	0	694,975.6

Food	14	0	719,879.4
	15	0	705,729.9
	1	54394	672,727.0
	2	54894	699,073.0
	3	52713	642,802.0
	4	58026	718,514.0
	5	53289	660,740.0
	6	58742	734,705.0
	7	60127	760,586.0
	8	55622	695,235.0
	9	55787	683,140.0
	10	57340	713,768.0
	11	57459	710,138.0
	12	57290	705,315.0
	13	0	708,397.8
14	0	707,817.7	
15	0	708,651.9	

<u>Category</u>	<u>PERIOD</u>	<u>Unit Sales</u>	<u>DOLLARS</u>
Coffee	1	61666	801,123.0
	2	54870	682,340.0
	3	61608	765,078.0
	4	57050	691,274.0
	5	59229	720,444.0
	6	58466	742,457.0
	7	60771	747,253.0
	8	54633	655,896.0
	9	57829	730,317.0
	10	57012	724,412.0
	11	51110	620,264.0
	12	58981	762,328.0
	13	0	694,975.0
	14	0	719,879.0
	15	0	705,729.0
Food	1	54394	672,727.0
	2	54894	699,073.0
	3	52713	642,802.0
	4	58026	718,514.0
	5	53289	660,740.0
	6	58742	734,705.0
	7	60127	760,586.0
	8	55622	695,235.0
	9	55787	683,140.0
	10	57340	713,768.0
	11	57459	710,138.0
	12	57290	705,315.0
	13	0	708,397.0
	14	0	707,817.0
	15	0	708,651.0

Using Single Exponential Smoothing

The single exponential smoothing method calculates an average that allows you to choose weights to apply to newer and older values.

The following formula determines the weight given to the newest value.

$$k = 2/(1+n)$$

where:

k

Is the newest value.

n

Is an integer greater than one. Increasing n increases the weight assigned to the earlier observations (or data instances), as compared to the later ones.

The next calculation of the exponential moving average (EMA) value is derived by the following formula:

$$\text{EMA} = (\text{EMA} * (1-k)) + (\text{datavalue} * k)$$

This means that the newest value from the data source is multiplied by the factor k and the current moving average is multiplied by the factor $(1-k)$. These quantities are then summed to generate the new EMA.

i Note: When the data values are exhausted, the last data value in the sort group is used as the next data value.

Calculating a Single Exponential Smoothing Column

The following defines an integer value named PERIOD to use as the independent variable for the moving average. It predicts three periods of values beyond the range of retrieved data.

```
DEFINE FILE GGSales
  SDATE/YYM = DATE;
  SYEAR/Y = SDATE;
  SMONTH/M = SDATE;
  PERIOD/I2 = SMONTH;
END
TABLE FILE GGSales
  SUM UNITS DOLLARS
  BY CATEGORY BY PERIOD
  WHERE SYEAR EQ 97 AND CATEGORY NE 'Gifts'
  ON PERIOD RECAP EXPAVE/D10.1= FORECAST(DOLLARS,1,3,'EXPAVE',3);
END
```

The output is:

Category	PERIOD	Unit Sales	Dollar Sales	EXPAVE
-----	-----	-----	-----	-----
Coffee	1	61666	801123	801,123.0
	2	54870	682340	741,731.5
	3	61608	765078	753,404.8
	4	57050	691274	722,339.4
	5	59229	720444	721,391.7
	6	58466	742457	731,924.3
	7	60771	747253	739,588.7
	8	54633	655896	697,742.3
	9	57829	730317	714,029.7
	10	57012	724412	719,220.8
	11	51110	620264	669,742.4
	12	58981	762328	716,035.2
	13	0	0	739,181.6
	14	0	0	750,754.8
	15	0	0	756,541.4
Food	1	54394	672727	672,727.0
	2	54894	699073	685,900.0
	3	52713	642802	664,351.0
	4	58026	718514	691,432.5
	5	53289	660740	676,086.3
	6	58742	734705	705,395.6
	7	60127	760586	732,990.8
	8	55622	695235	714,112.9
	9	55787	683140	698,626.5
	10	57340	713768	706,197.2
	11	57459	710138	708,167.6
	12	57290	705315	706,741.3
	13	0	0	706,028.2
	14	0	0	705,671.6
	15	0	0	705,493.3

<u>Category</u>	<u>PERIOD</u>	<u>Unit Sales</u>	<u>Dollar Sales</u>	<u>EXPAVE</u>
Coffee	1	61666	801123	801,123.0
	2	54870	682340	741,731.5
	3	61608	765078	753,404.8
	4	57050	691274	722,339.4
	5	59229	720444	721,391.7
	6	58466	742457	731,924.3
	7	60771	747253	739,588.7
	8	54633	655896	697,742.3
	9	57829	730317	714,029.7
	10	57012	724412	719,220.8
	11	51110	620264	669,742.4
	12	58981	762328	716,035.2
	13	0	0	716,035.2
	14	0	0	716,035.2
	15	0	0	716,035.2
Food	1	54394	672727	672,727.0
	2	54894	699073	685,900.0
	3	52713	642802	664,351.0
	4	58026	718514	691,432.5
	5	53289	660740	676,086.3
	6	58742	734705	705,395.6
	7	60127	760586	732,990.8
	8	55622	695235	714,112.9
	9	55787	683140	698,626.5
	10	57340	713768	706,197.2
	11	57459	710138	708,167.6
	12	57290	705315	706,741.3
	13	0	0	706,028.3
	14	0	0	705,671.6
	15	0	0	705,493.3

In the report, three predicted values of EXPAVE are calculated within each value of CATEGORY. For values outside the range of the data, new PERIOD values are generated by adding the interval value (1) to the prior PERIOD value.

Each average (EXPAVE value) is computed using DOLLARS values where they exist. The calculation of the moving average begins in the following way:

- The first EXPAVE value (801,123.0) is the same as the first DOLLARS value.
- The second EXPAVE value (741,731.5) is calculated as follows. Note that because of rounding and the number of decimal places used, the value derived in this sample calculation varies slightly from the one displayed in the report output:

n=3 (number used to calculate weights)

$$k = 2/(1+n) = 2/4 = 0.5$$

$$\text{EXPAVE} = (\text{EXPAVE} \times (1-k)) + (\text{new-DOLLARS} \times k) = (801123 \times 0.5) + (682340 \times 0.50) = 400561.5 + 341170 = 741731.5$$

- The third EXPAVE value (753,404.8) is calculated as follows:

$$\text{EXPAVE} = (\text{EXPAVE} \times (1-k)) + (\text{new-DOLLARS} \times k) = (741731.5 \times 0.5) + (765078 \times 0.50) = 370865.75 + 382539 = 753404.75$$

For predicted values beyond those supplied, the last EXPAVE value is used as the new data point in the exponential smoothing calculation. The predicted EXPAVE values (starting with 706,741.6) are calculated using the previous average and the new data point. Because the previous average is also used as the new data point, the predicted values are always equal to the last trend value. For example, the previous average for period 13 is 706,741.6, and this is also used as the next data point. Therefore, the average is calculated as follows: $(706,741.6 * 0.5) + (706,741.6 * 0.5) = 706,741.6$

$$\text{EXPAVE} = (\text{EXPAVE} * (1-k)) + (\text{new-DOLLARS} * k) = (706741.6 \times 0.5) + (706741.6 \times 0.50) = 353370.8 + 353370.8 = 706741.6$$

Using Double Exponential Smoothing

Double exponential smoothing produces an exponential moving average that takes into account the tendency of data to either increase or decrease over time without repeating. This is accomplished by using two equations with two constants.

- The first equation accounts for the current time period and is a weighted average of the current data value and the prior average, with an added component (b) that represents the trend for the previous period. The weight constant is k:

$$\text{DOUBLEXP}(t) = k * \text{datavalue}(t) + (1-k) * ((\text{DOUBLEXP}(t-1) + b(t-1)))$$

- The second equation is the calculated trend value, and is a weighted average of the difference between the current and previous average and the trend for the previous time period. $b(t)$ represents the average trend. The weight constant is g:

$$b(t) = g * (\text{DOUBLEXP}(t) - \text{DOUBLEXP}(t-1)) + (1 - g) * (b(t-1))$$

These two equations are solved to derive the smoothed average. The first smoothed average is set to the first data value. The first trend component is set to zero. For choosing the two constants, the best results are usually obtained by minimizing the mean-squared error (MSE) between the data values and the calculated averages. You may need to use nonlinear optimization techniques to find the optimal constants.

The equation used for forecasting beyond the data points with double exponential smoothing is

$$\text{forecast}(t+m) = \text{DOUBLEXP}(t) + m * b(t)$$

where:

m

Is the number of time periods ahead for the forecast.

Calculating a Double Exponential Smoothing Column

The following sums the ACTUAL_YTD field of the CENTSTMT data source by period, and calculates a single exponential and double exponential moving average.

```
SET HISTOGRAM = OFF
TABLE FILE CENTSTMT
SUM ACTUAL_YTD
  BY PERIOD
  ON PERIOD RECAP EXP/D15.1 = FORECAST(ACTUAL_YTD,1,0,'EXPAVE',3);
  ON PERIOD RECAP DOUBLEXP/D15.1 = FORECAST(ACTUAL_YTD,1,0,
    'DOUBLEXP',3,3);
WHERE GL_ACCOUNT LIKE '3%%%'
END
```

The output is:

PERIOD	YTD Actual	EXP	DOUBLEXP
--------	---------------	-----	----------

-----	-----	---	-----
2002/01	12,957,681.	12,957,681.0	12,957,681.0
2002/02	25,441,971.	19,199,826.0	22,439,246.3
2002/03	39,164,321.	29,182,073.5	34,791,885.1
2002/04	52,733,326.	40,957,699.8	48,845,816.0
2002/05	66,765,920.	53,861,809.9	63,860,955.9
2002/06	80,952,492.	67,407,150.9	79,188,052.9

PERIOD	YTD		
	Actual	EXP	DOUBLEXP
2002/01	12,957,681.	12,957,681.0	12,957,681.0
2002/02	25,441,971.	19,199,826.0	22,439,246.3
2002/03	39,164,321.	29,182,073.5	34,791,885.1
2002/04	52,733,326.	40,957,699.8	48,845,816.0
2002/05	66,765,920.	53,861,809.9	63,860,955.9
2002/06	80,952,492.	67,407,150.9	79,188,052.9

Using Triple Exponential Smoothing

Triple exponential smoothing produces an exponential moving average that takes into account the tendency of data to repeat itself in intervals over time. For example, sales data that is growing and in which 25% of sales always occur during December contains both trend and seasonality. Triple exponential smoothing takes both the trend and seasonality into account by using three equations with three constants.

For triple exponential smoothing you, need to know the number of data points in each time period (designated as L in the following equations). To account for the seasonality, a seasonal index is calculated. The data is divided by the prior season index and then used in calculating the smoothed average.

- The first equation accounts for the current time period, and is a weighted average of the current data value divided by the seasonal factor and the prior average adjusted for the trend for the previous period. The weight constant is k:

$$\text{SEASONAL}(t) = k * (\text{datavalue}(t)/I(t-L)) + (1-k) * (\text{SEASONAL}(t-1) + b(t-1))$$

- The second equation is the calculated trend value, and is a weighted average of the difference between the current and previous average and the trend for the previous time period. $b(t)$ represents the average trend. The weight constant is g:

$$b(t) = g * (SEASONAL(t) - SEASONAL(t-1)) + (1-g) * (b(t-1))$$

- The third equation is the calculated seasonal index, and is a weighted average of the current data value divided by the current average and the seasonal index for the previous season. $I(t)$ represents the average seasonal coefficient. The weight constant is p :

$$I(t) = p * (datavalue(t)/SEASONAL(t)) + (1 - p) * I(t-L)$$

These equations are solved to derive the triple smoothed average. The first smoothed average is set to the first data value. Initial values for the seasonality factors are calculated based on the maximum number of full periods of data in the data source, while the initial trend is calculated based on two periods of data. These values are calculated with the following steps:

1. The initial trend factor is calculated by the following formula:

$$b(0) = (1/L) ((y(L+1)-y(1))/L + (y(L+2)-y(2))/L + \dots + (y(2L) - y(L))/L)$$

2. The calculation of the initial seasonality factor is based on the average of the data values within each period, $A(j)$ ($1 \leq j \leq N$):

$$A(j) = (y((j-1)L+1) + y((j-1)L+2) + \dots + y(jL)) / L$$

3. Then, the initial periodicity factor is given by the following formula, where N is the number of full periods available in the data, L is the number of points per period and n is a point within the period ($1 \leq n \leq L$):

$$I(n) = (y(n)/A(1) + y(L+n)/A(2) + \dots + y((N-1)L+n)/A(N)) / N$$

The three constants must be chosen carefully. The best results are usually obtained by choosing the constants to minimize the mean-squared error (MSE) between the data values and the calculated averages. Varying the values of $npoint1$ and $npoint2$ affect the results, and some values may produce a better approximation. To search for a better approximation, you may want to find values that minimize the MSE.

The equation used to forecast beyond the last data point with triple exponential smoothing is:

$$\text{forecast}(t+m) = (\text{SEASONAL}(t) + m * b(t)) / I(t-L+\text{MOD}(m/L))$$

where:

m

Is the number of periods ahead for the forecast.

Calculating a Triple Exponential Smoothing Column

In the following, the data has seasonality but no trend. Therefore, *npoint2* is set high (1000) to make the trend factor negligible in the calculation:

```
SET HISTOGRAM = OFF
TABLE FILE VIDEOTRK
SUM TRANSTOT
BY  TRANSDATE
ON  TRANSDATE RECAP SEASONAL/D10.1 = FORECAST(TRANSTOT,1,3,'SEASONAL',
      3,3,1000,1);
WHERE TRANSDATE NE '19910617'
END
```

In the output, *npredict* is 3. Therefore, three periods (nine points, *nperiod* * *npredict*) are generated.

TRANSDATE	TRANSTOT	SEASONAL
-----	-----	-----
91/06/18	21.25	21.3
91/06/19	38.17	31.0
91/06/20	14.23	34.6
91/06/21	44.72	53.2
91/06/24	126.28	75.3
91/06/25	47.74	82.7
91/06/26	40.97	73.7
91/06/27	60.24	62.9
91/06/28	31.00	66.3
91/06/29		45.7
91/06/30		94.1
91/07/01		53.4
91/07/02		72.3
91/07/03		140.0
91/07/04		75.8

91/07/05	98.9
91/07/06	185.8
91/07/07	98.2

TRANSDATE	TRANSTOT	SEASONAL
91/06/18	21.25	21.3
91/06/19	38.17	31.0
91/06/20	14.23	34.6
91/06/21	44.72	53.2
91/06/24	126.28	75.3
91/06/25	47.74	82.7
91/06/26	40.97	73.7
91/06/27	60.24	62.9
91/06/28	31.00	66.3
91/06/29		45.7
91/06/30		94.1
91/07/01		53.4
91/07/02		72.3
91/07/03		140.0
91/07/04		75.8
91/07/05		98.9
91/07/06		185.8
91/07/07		98.2

Using a Linear Regression Equation

The Linear Regression Equation estimates values by assuming that the dependent variable (the new calculated values) and the independent variable (the sort field values) are related by a function that represents a straight line:

$$y = mx + b$$

where:

y

Is the dependent variable.

x

Is the independent variable.

m

Is the slope of the line.

b

Is the y-intercept.

REGRESS uses a technique called Ordinary Least Squares to calculate values for m and b that minimize the sum of the squared differences between the data and the resulting line.

The following formulas show how m and b are calculated.

$$m = \frac{(\sum xy - (\sum x \cdot \sum y) / n)}{(\sum x^2 - (\sum x)^2 / n)}$$

$$b = (\sum y) / n - (m \cdot (\sum x) / n)$$

where:

n

Is the number of data points.

y

Is the data values (dependent variables).

x

Is the sort field values (independent variables).

Trend values, as well as predicted values, are calculated using the regression line equation.

Calculating a New Linear Regression Field

TABLE FILE CAR
PRINT MPG

```

BY DEALER_COST
WHERE MPG NE 0.0
  ON DEALER_COST RECAP FORMPG=FORECAST(MPG,1000,3,'REGRESS');
END

```

The output is:

<u>DEALER_COST</u>	<u>MPG</u>	<u>FORMPG</u>
2,886	27	25.51
4,292	25	23.65
4,631	21	23.20
4,915	21	22.82
5,063	23	22.63
5,660	21	21.83
	21	21.83
5,800	24	21.65
6,000	24	21.38
7,427	16	19.49
8,300	18	18.33
8,400	18	18.20
10,000	18	16.08
11,000	18	14.75
11,194	9	14.50
14,940	11	9.53
15,940	0	8.21
16,940	0	6.88
17,940	0	5.55

i Note:

- Three predicted values of FORMPG are calculated. For values outside the range of the data, new DEALER_COST values are generated by adding the interval value (1,000) to the prior DEALER_COST value.
- There are no MPG values for the generated DEALER_COST values.
- Each FORMPG value is computed using a regression line, calculated using all of the actual data values for MPG.

DEALER_COST is the independent variable (x) and MPG is the dependent variable (y). The equation is used to calculate MPGFORECAST trend and predicted values.

In this case, the equation is approximately as follows:

$$\text{FORMPG} = (-0.001323 * \text{DEALER_COST}) + 29.32$$

The predicted values are (the values are not exactly as calculated by FORECAST because of rounding, but they show the calculation process).

DEALER_COST	Calculation	FORMPG
15,940	$(-0.001323 * 15,940) + 29.32$	8.23
16,940	$(-0.001323 * 16,940) + 29.32$	6.91
17,940	$(-0.001323 * 17,940) + 29.32$	5.59

FORECAST Reporting Techniques

You can use FORECAST multiple times in one request. However, all FORECAST requests must specify the same sort field, interval, and number of predictions. The only things that can change are the RECAP field, method, field used to calculate the FORECAST values, and number of points to average. If you change any of the other parameters, the new parameters are ignored.

If you want to move a FORECAST column in the report output, use an empty COMPUTE command for the FORECAST field as a placeholder. The data type (I, F, P, D) must be the same in the COMPUTE command and the RECAP command.

To make the report output easier to interpret, you can create a field that indicates whether the FORECAST value in each row is a predicted value. To do this, define a virtual field whose value is a constant other than zero. Rows in the report output that represent actual records in the data source will appear with this constant. Rows that represent predicted values will display zero. You can also propagate this field to a HOLD file.

Generating Multiple FORECAST Columns in a Request

This example calculates moving averages and exponential averages for both the DOLLARS and BUDDOLLARS fields in the GGSales data source. The sort field, interval, and number of predictions are the same for all of the calculations.

```

DEFINE FILE GGSales
  SDATE/YYM = DATE;
  SYEAR/Y = SDATE;
  SMONTH/M = SDATE;
  PERIOD/I2 = SMONTH;
END
TABLE FILE GGSales
  SUM DOLLARS AS 'DOLLARS' BUDDOLLARS AS 'BUDGET'
  BY CATEGORY NOPRINT BY PERIOD AS 'PER'
  WHERE SYEAR EQ 97 AND CATEGORY EQ 'Coffee'
  ON PERIOD RECAP DOLMOVAVE/D10.1= FORECAST(DOLLARS,1,0,'MOVAVE',3);
  ON PERIOD RECAP DOLEXPAVE/D10.1= FORECAST(DOLLARS,1,0,'EXPAVE',4);
  ON PERIOD RECAP BUDMOVAVE/D10.1 = FORECAST(BUDDOLLARS,1,0,'MOVAVE',3);
  ON PERIOD RECAP BUDEXPAVE/D10.1 = FORECAST(BUDDOLLARS,1,0,'EXPAVE',4);
END

```

The output is shown in the following image.

PER	DOLLARS	BUDGET	DOLMOVAVE	DOLEXPAVE	BUDMOVAVE	BUDEXPAVE
1	801123	801375	801,123.0	801,123.0	801,375.0	801,375.0
2	682340	725117	741,731.5	753,609.8	763,246.0	770,871.8
3	765078	810367	749,513.7	758,197.1	778,953.0	786,669.9
4	691274	717688	712,897.3	731,427.8	751,057.3	

```

759,077.1
 5  720444  739999  725,598.7  727,034.3  756,018.0
751,445.9
 6  742457  742586  718,058.3  733,203.4  733,424.3
747,901.9
 7  747253  773136  736,718.0  738,823.2  751,907.0
757,995.6
 8  655896  685170  715,202.0  705,652.3  733,630.7
728,865.3
 9  730317  753760  711,155.3  715,518.2  737,355.3
738,823.2
10  724412  709397  703,541.7  719,075.7  716,109.0
727,052.7
11  620264  630452  691,664.3  679,551.0  697,869.7
688,412.4
12  762328  718837  702,334.7  712,661.8  686,228.7
700,582.3

```

PER	DOLLARS	BUDGET	DOLMOVAVE	DOLEXPAVE	BUDMOVAVE	BUDEXPAVE
1	801123	801375	801,123.0	801,123.0	801,375.0	801,375.0
2	682340	725117	741,731.5	753,609.8	763,246.0	770,871.8
3	765078	810367	749,513.7	758,197.1	778,953.0	786,669.9
4	691274	717688	712,897.3	731,427.8	751,057.3	759,077.1
5	720444	739999	725,598.7	727,034.3	756,018.0	751,445.9
6	742457	742586	718,058.3	733,203.4	733,424.3	747,901.9
7	747253	773136	736,718.0	738,823.2	751,907.0	757,995.6
8	655896	685170	715,202.0	705,652.3	733,630.7	728,865.3
9	730317	753760	711,155.3	715,518.2	737,355.3	738,823.2
10	724412	709397	703,541.7	719,075.7	716,109.0	727,052.7
11	620264	630452	691,664.3	679,551.0	697,869.7	688,412.4
12	762328	718837	702,334.7	712,661.8	686,228.7	700,582.3

Moving the FORECAST Column

The following example places the DOLLARS field after the MOVAVE field by using an empty COMPUTE command as a placeholder for the MOVAVE field. Both the COMPUTE command and the RECAP command specify formats for MOVAVE (of the same data type), but the format of the RECAP command takes precedence.

```

DEFINE FILE GGSALLES
  SDATE/YYM = DATE;
  SYEAR/Y = SDATE;
  SMONTH/M = SDATE;
  PERIOD/I2 = SMONTH;
END
TABLE FILE GGSALLES

```



```

SUM    UNITS
COMPUTE MOVAVE/D10.2 = ;
DOLLARS
  BY CATEGORY BY PERIOD
  WHERE SYEAR EQ 97 AND CATEGORY EQ 'Coffee'
  ON PERIOD RECAP MOVAVE/D10.1= FORECAST(DOLLARS,1,3,'MOVAVE',3);
END

```

The output is shown in the following image.

Category	PERIOD	Unit Sales	MOVAVE	Dollar Sales
Coffee	1	61666	801,123.0	801123
	2	54870	741,731.5	682340
	3	61608	749,513.7	765078
	4	57050	712,897.3	691274
	5	59229	725,598.7	720444
	6	58466	718,058.3	742457
	7	60771	736,718.0	747253
	8	54633	715,202.0	655896
	9	57829	711,155.3	730317
	10	57012	703,541.7	724412
	11	51110	691,664.3	620264
	12	58981	702,334.7	762328
	13	0	694,975.6	0
	14	0	719,879.4	0
	15	0	705,729.9	0

Distinguishing Data Rows From Predicted Rows

In the following example, the DATA_ROW virtual field has the value 1 for each row in the data source. It has the value zero for the predicted rows. The PREDICT field is calculated as YES for predicted rows, and NO for rows containing data.

```

DEFINE FILE CAR
DATA_ROW/I1 = 1;
END
TABLE FILE CAR
  PRINT DATA_ROW
COMPUTE PREDICT/A3 = IF DATA_ROW EQ 1 THEN 'NO' ELSE 'YES' ;
MPG
BY DEALER_COST

```

```

WHERE MPG GE 20
  ON DEALER_COST RECAP FORMPG/D12.2=FORECAST(MPG,1000,3,'REGRESS');
  ON DEALER_COST RECAP MPG          =FORECAST(MPG,1000,3,'REGRESS');
END

```

The output is:

DEALER_COST	DATA_ROW	PREDICT	MPG	FORMPG	MPG
2,886	1	NO	27.00		25.65
4,292	1	NO	25.00		23.91
4,631	1	NO	21.00		23.49
4,915	1	NO	21.00		23.14
5,063	1	NO	23.00		22.95
5,660	1	NO	21.00		22.21
	1	NO	21.00		22.21
5,800	1	NO	24.20		22.04
6,000	1	NO	24.20		21.79
7,000	0	YES	20.56		20.56
8,000	0	YES	19.32		19.32
9,000	0	YES	18.08		18.08

Calculating Trends and Predicting Values With Multivariate REGRESS

The REGRESS method derives a linear equation that best fits a set of numeric data points, and uses this equation to create a new column in the report output. The equation can be based on one to three independent variables.

This method estimates values by assuming that the dependent variable (y , the new calculated values) and the independent variables ($x1$, $x2$, $x3$) are related by the following linear equation:

$$y = a1*x1 [+ a2*x2 [+ a3*x3]] + b$$

When there is one independent variable, the equation represents a straight line. This produces the same values as FORECAST using the REGRESS method. When there are two independent variables, the equation represents a plane, and with three independent variables, it represents a hyperplane. You should use this technique when you have reason

to believe that the dependent variable can be approximated by a linear combination of the independent variables.

REGRESS uses a technique called Ordinary Least Squares to calculate values for the coefficients (a_1 , a_2 , a_3 , and b) that minimize the sum of the squared differences between the data and the resulting line, plane, or hyperplane.

Create a Multivariate Linear Regression Column

```
ON {sortfield} RECAP y[/fmt] = REGRESS(n, x1, [x2, [x3,]] z);
```

where:

sortfield

Is a field in the data source. It cannot be the same field as any of the parameters to REGRESS. A new linear regression equation is derived each time the sort field value changes.

y

Is the new numeric column calculated by applying the regression equation. You cannot DEFINE or COMPUTE a field with this name.

fmt

Is the display format for y. If it is omitted, the default format is D12.2.

n

Is a whole number from 1 to 3 indicating the number of independent variables.

x1, x2, x3

Are the field names to be used as the independent variables. All of these variables must be numeric and be independent of each other.

z

Is an existing numeric field that is assumed to be approximately linearly dependent on the independent variables and is used to derive the regression equation.

Usage Notes for REGRESS

- The (By) sort field used with REGRESS must be in a numeric or date format.
- REGRESS cannot operate on an ACROSS field.
- If any of the independent variables are also sort fields, they cannot be referenced in the request prior to the REGRESS sort field.
- FORECAST and REGRESS cannot be used in the same request, and only one REGRESS is supported in a request. Non-REGRESS RECAP commands are supported.
- The RECAP command used with REGRESS can contain only the REGRESS syntax. REGRESS does not recognize any syntax after the closing semicolon (;).
- Although you pass parameters to REGRESS using an argument list in parentheses, REGRESS is not a function. It can coexist with a user-written subroutine of the same name, as long as the user-written subroutine is not specified in a RECAP command.
- BY TOTAL is not supported.
- MORE, MATCH, FOR, and OVER are not supported.
- The process of generating the REGRESS values creates extra columns that are not printed in the report output. The number and placement of these additional columns varies depending on the specific request. Therefore, use of column notation is not supported in a request that includes REGRESS.
- SUMMARIZE and RECOMPUTE are not supported for the same sort field used for REGRESS.
- REGRESS is not supported for the FOCUS GRAPH facility.
- The left side of a RECAP command used for REGRESS supports the CURR attribute for creating a currency-denominated field.
- Fields with missing values cannot be used in the regression.
- Larger amounts of data produce more useful results.

Creating a Multivariate Linear Regression Column

The following request uses the GGSales data source to calculate an estimated DOLLARS column. The BUDUNITS, UNITS, and BUDDOLLARS fields are the independent variables. The

DOLLARS field provides the actual values to be estimated:

```
DEFINE FILE GGSALES
  YEAR/Y = DATE;
  MONTH/M = DATE;
  PERIOD/I2 = MONTH;
END
```

```
TABLE FILE GGSALES
PRINT BUDUNITS UNITS BUDDOLLARS DOLLARS
BY PERIOD
ON PERIOD
RECAP EST_DOLLARS/F8 = REGRESS(3, BUDUNITS, UNITS, BUDDOLLARS, DOLLARS);
WHERE CATEGORY EQ 'Coffee'
WHERE REGION EQ 'West'
WHERE UNITS GT 1600 AND UNITS LT 1700
END
```

The output is:

PERIOD	Budget Units	Unit Sales	Budget Dollars	Dollar Sales	EST_
DOLLARS					
-----	-----	-----	-----	-----	-----
--					
1	1665	1678	21645	23492	
0					
	1725	1669	22425	21697	
0					
2	1613	1685	22582	18535	
13334					
	1568	1682	23520	25230	
14225					
	1847	1668	18470	25020	
9607					
3	1646	1656	23044	19872	
19872					
	1759	1615	17590	17765	
17765					
	1498	1637	16478	21281	
21281					
	1653	1694	21489	16940	
16940					
4	1457	1671	21855	20052	
0					
5	1662	1674	24930	18414	

0						
6	1825	1695	23725	25425	-	
41807						
	1870	1620	24310	24300	-	
50319						
	1712	1640	22256	16400	-	
37004						
7	1727	1623	24178	17853	-	
25413						
	1733	1647	17330	24705	-	
8127						
8	1830	1652	20130	23128		
6021						
	1451	1660	17412	19920		
7369						
	1556	1643	18672	18073		
7495						
9	1464	1663	14640	23282		
11325						
	1463	1663	21945	19956		
25036						
10	1464	1667	17568	25005		
25005						
	1711	1623	20532	22722		
22722						
	1701	1626	18711	21138		
21138						
	1473	1616	14730	16160		
16160						
11	1403	1601	21045	17611		
0						
12	1796	1696	17960	25440		
0						

<u>PERIOD</u>	<u>Budget Units</u>	<u>Unit Sales</u>	<u>Budget Dollars</u>	<u>Dollar Sales</u>	<u>EST DOLLARS</u>
1	1665	1678	21645	23492	0
	1725	1669	22425	21697	0
2	1613	1685	22582	18535	19065
	1568	1682	23520	25230	19089
	1847	1668	18470	25020	19725
3	1646	1656	23044	19872	19871
	1759	1615	17590	17765	17765
	1498	1637	16478	21281	21280
	1653	1694	21489	16940	16940
4	1457	1671	21855	20052	0
5	1662	1674	24930	18414	0
6	1825	1695	23725	25425	32228
	1870	1620	24310	24300	30866
	1712	1640	22256	16400	31859
7	1727	1623	24178	17853	-26821
	1733	1647	17330	24705	-13637
8	1830	1652	20130	23128	51170
	1451	1660	17412	19920	15755
	1556	1643	18672	18073	20517
9	1464	1663	14640	23282	18249
	1463	1663	21945	19956	23005
10	1464	1667	17568	25005	25005
	1711	1623	20532	22722	22722
	1701	1626	18711	21138	21138
	1473	1616	14730	16160	16160
11	1403	1601	21045	17611	0
12	1796	1696	17960	25440	0

Using Text Fields in DEFINE and COMPUTE

Text fields can be assigned to alphanumeric fields and receive assignment from alphanumeric fields. If an alphanumeric field is assigned the value of a text field that is too long for the alphanumeric field, the value is truncated before being assigned to the alphanumeric field.

i **Note:** COMPUTE commands in Maintain do not support text fields.

Assigning the Result of an Alphanumeric Expression to a Text Field

This example uses the COURSES data source, which contains a text field, to create an alphanumeric field named ADESC, which truncates the text field at 36 characters, and a new text field named NEWDESC, which is a text version of ADESC:

```
DEFINE FILE COURSES
ADESC/A36 = DESCRIPTION;
NEWDESC/TX36 = ADESC;
END

TABLE FILE COURSES
PRINT ADESC NEWDESC
END
```

The output is:

ADESC -----	NEWDESC -----
This course provides the DP professi professi Anyone responsible for designing FOC FOC This is a course in FOCUS efficienci efficienci	This course provides the DP Anyone responsible for designing This is a course in FOCUS

Creating Temporary Fields Independent of a Master File

The temporary fields you create with the DEFINE and COMPUTE commands are tied to a specific Master File, and in the case of values calculated with the COMPUTE command, to a specific request. However, you can create temporary fields that are independent of either a Master File or a request using the DEFINE FUNCTION command.

A DEFINE function is a named group of calculations that use any number of input values and produce a return value. When calling a DEFINE function, you must first define the function.

A DEFINE function can be called in most of the same situations that are valid for FOCUS-supplied functions. Data types are defined with each argument. When substituting values for these arguments, the format must match the defined format. Alphanumeric arguments shorter than the specified format are padded with blanks, while longer alphanumeric arguments are truncated.

All calculations within the function are done in double precision. Format conversions occur only across equal signs (=) in the assignments that define temporary fields.

Define a Function

```
DEFINE FUNCTION name (argument1/format1,..., argumentn/formatn)
[tempvariablea/formata [TITLE 'line1[,line2 ...']
 [DESCRiption 'description'] = expressiona;]
.
.
.
[tempvariablex/formatx = expressionx;]
name/format = [result_expression];
END
```

where:

name

Is the name of the function, up to 64 characters. This must be the last field calculated in the function, and is used to return the value of the function to the calling procedure.

argument1...argumentn

Are the argument names. They can be any names that comply with FOCUS field naming rules.

format1...formatn

Are the formats of the function arguments.

If the format of an argument is alphanumeric, the argument value must also be alphanumeric. Shorter arguments are padded on the right with blanks, and longer arguments are truncated.

If the format of an argument is numeric, the argument value must also be numeric. To prevent unexpected results, you must be consistent in your use of data types.

tempvariablea...tempvariablex

Are temporary fields. Temporary fields hold intermediate values used in the function. You can define as many temporary fields as you need.

tempformata...tempformatx

Are the formats of the temporary fields.

line1,line2 ...

Are the lines of default column title to be displayed for the virtual field unless overridden by an AS phrase.

description

Is the description to be associated with the virtual field, enclosed in single quotation marks.

expressiona...expressionx

Are the expressions that calculate the temporary field values. The expressions can use parameters, constants, and other temporary fields defined in the same function.

format

Is the format of the value the function returns.

result_expression

Is the expression that calculates the value returned by the function. The expression can use parameters, constants, and temporary fields defined in the same function.

All names defined in the body of the function are local to the function. The last field defined before the END command in the function definition must have the same name as the function, and represents the return value for the function.

DEFINE Function Limits and Restrictions

- The number of functions you can define and use in a session is virtually unlimited.
- A DEFINE function is cleared with the DEFINE FUNCTION CLEAR command. It is not cleared by issuing a join, or by any FOCUS command.

- When an expression tries to use a cleared function, an error appears.
- DEFINE functions can call other DEFINE functions, but cannot call themselves.
- If you overwrite or clear a DEFINE function, a subsequent attempt to use a temporary field that refers to the function generates the following warning:

```
(FOC03665) Error loading external function '%1'
```

Defining a Function

The following example creates and calls the SUBTRACT function. SUBTRACT performs a calculation with the arguments VAL1 and VAL2.

```
DEFINE FUNCTION SUBTRACT (VAL1/D8, VAL2/D8)
  SUBTRACT/D8.2 = VAL1 - VAL2;
END
```

```
TABLE FILE MOVIES
  PRINT TITLE LISTPR IN 35 WHOLESALPR AND
  COMPUTE PROFIT/D8.2 = SUBTRACT(LISTPR,WHOLESALPR);
  BY CATEGORY
  WHERE CATEGORY EQ 'MYSTERY' OR 'ACTION'
END
```

The output is:

CATEGORY	TITLE	LISTPR	WHOLESALPR	PROFIT
-----	-----	-----	-----	-----
ACTION	JAWS	19.95	10.99	8.96
	ROBOCOP	19.98	11.50	8.48
	TOTAL RECALL	19.99	11.99	8.00
	TOP GUN	14.95	9.99	4.96
MYSTERY	RAMBO III	19.95	10.99	8.96
	REAR WINDOW	19.98	9.00	10.98
	VERTIGO	19.98	9.00	10.98
	FATAL ATTRACTION	29.98	15.99	13.99
	NORTH BY NORTHWEST	19.98	9.00	10.98
	DEAD RINGERS	25.99	15.99	10.00
	MORNING AFTER, THE	19.95	9.99	9.96
	PSYCHO	19.98	9.00	10.98

BIRDS, THE	19.98	9.00	10.98
SEA OF LOVE	59.99	30.00	29.99

Display DEFINE Functions

Issue the following command from the Command Console:

```
? FUNCTION
```

Displaying DEFINE Functions

Issuing the command

```
? FUNCTION
```

displays information similar to the following:

FUNCTIONS	CURRENTLY	ACTIVE	
NAME	FORMAT	PARAMETER	FORMAT
-----	-----	-----	-----
SUBTRACT	D8.2	VAL1	D8
		VAL2	D8

If you issue the ? FUNCTION command when no functions are defined, the following appears:

```
NO FUNCTIONS CURRENTLY IN EFFECT
```

Clear DEFINE Functions

```
DEFINE FUNCTION {name|*} CLEAR
```

where:

name

Is the name of the function name to clear.

Clears all active DEFINE functions.

Including Totals and Subtotals

To help interpret detailed information in a report, you can summarize the information using row and column totals, grand totals, and subtotals. You can use these summary lines in a report to clarify or highlight information.

Calculating Row and Column Totals

You can produce totals for rows or columns of numbers in a report. Use:

- ROW-TOTAL to display a new column containing the sum of all numbers in each row.
- COLUMN-TOTAL to display a final row on the report, which contains the totals for each column of numbers.

You can use row totals and column totals in matrix reports (created by using a BY and an ACROSS in your report request), rename row and column total titles, and include calculated values in your row or column totals. You can also create row totals using ACROSS-TOTAL.

Note that when producing totals in a report, if one field is summed, the format of the row total is the same as the format of the field. For example, if the format of the CURR_SAL field is D12.2M, the format of the row total for CURR_SAL is also D12.2M. When you are summing fields with different formats, the default format of D12.2 is used for the total.

Calculate Row and Column Totals

```
display_command fieldname AND ROW-TOTAL [alignment][/format] [AS 'name']  
display_command fieldname AND COLUMN-TOTAL [alignment][AS 'name']
```

where:

display_command

Is one of the following commands: PRINT, LIST, SUM, or COUNT.

fieldname

Is the name of the field for which to calculate row and/or column totals.

alignment

Specifies the alignment of the ROW-TOTAL or COLUMN-TOTAL label. Possible values are:

/R right justifies the label.

/L left justifies the label.

/C centers the label.

Note that these alignment settings are ignored in HTML output.

format

Reformats the ROW-TOTAL.

name

Is the label for the ROW-TOTAL or COLUMN-TOTAL.

You may also specify row or column totals with the ON TABLE command. Field names are optional with COLUMN-TOTAL, and cannot be listed with ROW-TOTAL. Use the following syntax:

```
ON TABLE COLUMN-TOTAL [alignment][AS 'name'] [field field field]
ON TABLE ROW-TOTAL [alignment][ /format] [AS 'name']
```

Calculating Row and Column Totals

The following request illustrates the use of ROW-TOTAL and COLUMN-TOTAL. The column and row total labels are "TOTAL" by default. You can change them using an AS phrase.

```
TABLE FILE SALES
SUM RETURNS DAMAGED AND ROW-TOTAL AND COLUMN-TOTAL
BY PROD_CODE
END
```

The output is:

PROD_CODE	RETURNS	DAMAGED	TOTAL
-----	-----	-----	-----
B10	13	10	23
B12	4	3	7
B17	4	2	6
B20	1	2	3
C13	3	0	3
C17	0	0	0
C7	5	4	9
D12	3	2	5
E1	4	7	11
E2	9	4	13
E3	12	11	23
TOTAL	58	45	103

Specifying Column Totals With ON TABLE

The following request illustrates the use of COLUMN-TOTAL with the ON TABLE command.

```
TABLE FILE EMPLOYEE
PRINT CURR_SAL
BY LAST_NAME
ON TABLE COLUMN-TOTAL
END
```

The output is:

LAST_NAME	CURR_SAL
-----	-----
BANNING	\$29,700.00
BLACKWOOD	\$21,780.00
CROSS	\$27,062.00
GREENSPAN	\$9,000.00
IRVING	\$26,862.00
JONES	\$18,480.00
MCCOY	\$18,480.00
MCKNIGHT	\$16,100.00
ROMANS	\$21,120.00
SMITH	\$13,200.00
	\$9,500.00

STEVENS	\$11,000.00
TOTAL	\$222,284.00

Using Row and Column Totals in a Matrix Report

The following request illustrates the use of ROW-TOTAL and COLUMN-TOTAL in a matrix report (created by using the BY and ACROSS phrases together).

```
TABLE FILE EMPLOYEE
SUM CURR_SAL AND ROW-TOTAL AND COLUMN-TOTAL
BY BANK_NAME
ACROSS DEPARTMENT
END
```

The output is:

BANK_NAME	DEPARTMENT		
	MIS	PRODUCTION	TOTAL

ASSOCIATED	\$40,680.00	\$41,620.00	\$82,300.00
BANK ASSOCIATION	\$21,780.00	\$42,962.00	\$64,742.00
BEST BANK	\$27,062.00	.	\$27,062.00
STATE	.	\$29,700.00	\$29,700.00
TOTAL	\$18,480.00	.	\$18,480.00
TOTAL	\$108,002.00	\$114,282.00	\$222,284.00

Renaming Row and Column Totals in Sorted Reports (BY)

The following request illustrates how to rename the ROW-TOTAL and COLUMN-TOTAL labels in a report that is sorted vertically.

```
TABLE FILE CAR
SUM DCOST RCOST ROW-TOTAL/C/D12 AS 'TOTAL_COST'
BY COUNTRY
ON TABLE COLUMN-TOTAL/C AS 'FINAL_TOTAL'
END
```

The output is:

COUNTRY	DEALER_COST	RETAIL_COST	TOTAL_COST
ENGLAND	37,853	45,319	83,172
FRANCE	4,631	5,610	10,241
ITALY	41,235	51,065	92,300
JAPAN	5,512	6,478	11,990
W GERMANY	54,563	64,732	119,295
FINAL_TOTAL	143,794	173,204	316,998

Including Calculated Values in Row and Column Totals

The following request illustrates the inclusion of the calculated value, PROFIT, in row and column totals.

```
TABLE FILE CAR
SUM DCOST RCOST
COMPUTE PROFIT/D12=RCOST-DCOST;
ROW-TOTAL/L/D12 AS 'TOTAL_COST'
BY COUNTRY
ON TABLE COLUMN-TOTAL/L AS 'FINAL_TOTAL'
END
```

The output is:

COUNTRY	DEALER_COST	RETAIL_COST	PROFIT	TOTAL_COST
ENGLAND	37,853	45,319	7,466	90,638
FRANCE	4,631	5,610	979	11,220
ITALY	41,235	51,065	9,830	102,130

JAPAN	5,512	6,478	966	12,956
W GERMANY	54,563	64,732	10,169	129,464
FINAL_TOTAL	143,794	173,204	29,410	346,408

Using ROW-TOTAL With ACROSS and Multiple Display Commands

When a request has an ACROSS sort field, each ACROSS value displays a column for each field displayed on the report output. For example, in the following request, each state has a column for units and a column for dollars:

```
TABLE FILE GGSALES
SUM UNITS AS 'U' DOLLARS AS 'D' BY CITY
ACROSS ST
IF ST EQ 'CA'
IF BUDUNITS NE MISSING
END
```

The output is:

City	State	
	CA	
	U	D
Los Angeles	298070	3772014
San Francisco	312500	3870258

When you specify a row total with ACROSS, the row total is calculated separately for each column in each ACROSS group. For example, in the following request the row total has a column for units and a column for dollars:

```
TABLE FILE GGSALES
SUM UNITS AS 'U' DOLLARS AS 'D' BY CITY
ACROSS ST
IF ST EQ 'CA'
IF BUDUNITS NE MISSING
```

```
ON TABLE ROW-TOTAL
END
```

The output is:

City	State CA		TOTAL	
	U	D	U	D
Los Angeles	298070	3772014	298070	3772014
San Francisco	312500	3870258	312500	3870258

When the request also has multiple display commands, each additional command adds additional columns to each ACROSS group on the report output.

The first column of the row total group is calculated by adding the first column from each display command under each ACROSS value, the second column adds the second column from each display command, and so on.

For example, the following request has a SUM command for units and dollars and another SUM command for budgeted units and budgeted dollars. The row total has a column for the sum of units and budgeted units and another column for the sum of dollars and budgeted dollars:

```
TABLE FILE GGSales
SUM UNITS AS 'U' DOLLARS AS 'D'          BY CITY
SUM BUDUNITS AS 'BU' BUDDOLLARS AS 'BD' BY CITY
ACROSS ST
IF ST EQ 'CA'
IF BUDUNITS NE MISSING
ON TABLE ROW-TOTAL
END
```

The output is:

City	State CA		TOTAL			
	U	D	BU	BD	BU	BD
Los Angeles	298070	3772014	295637	3669484	593707	7441498
San Francisco	312500	3870258	314725	3916863	627225	7787121

If the different display commands do not all specify the same number of fields, some columns will not be represented in the row total. For example, in the following request, the second SUM command has a column for budgeted units but not for budgeted dollars. Therefore, the row total group has no column for dollars:

```
TABLE FILE GGSales
SUM UNITS AS 'U' DOLLARS AS 'D' BY CITY
SUM BUDUNITS AS 'BU'          BY CITY
ACROSS ST
IF ST EQ 'CA'
IF BUDUNITS NE MISSING
ON TABLE ROW-TOTAL
END
```

The output is:

City	State CA			TOTAL
	U	D	BU	BU
Los Angeles	298070	3772014	295637	593707
San Francisco	312500	3870258	314725	627225

In this case, you can use column notation to calculate the row total properly. For example, the following request calculates the row total column by adding the units, dollars, and budgeted units columns together:

```
TABLE FILE GGSales
SUM UNITS AS 'U' DOLLARS AS 'D' BY CITY
SUM BUDUNITS AS 'BU'          BY CITY
ACROSS ST
COMPUTE TOTAL/I10 = C1 + C2 +C3; AS 'ROW-TOTAL'
IF ST EQ 'CA'
IF BUDUNITS NE MISSING
END
```

The output is:

City	State CA			ROW-TOTAL
	U	D	BU	

Los Angeles	298070	3772014	295637	4365721
San Francisco	312500	3870258	314725	4497483

Producing Row Totals for Horizontal (ACROSS) Sort Field Values

You can produce row totals for horizontal (ACROSS) sort field values. Row totals for horizontal sort fields, referenced by ACROSS-TOTAL, are different from standard row totals because only horizontal sort field values, referenced by ACROSS, are included in the total. Integer, single precision floating point, double precision floating point, packed, and long packed fields can all be totaled.

Produce Row Totals for Horizontal (ACROSS) Sort Field Values

```
ACROSS sortfield ACROSS-TOTAL [AS 'name'] [COLUMNS col1 AND col2 ...]
```

where:

sortfield

Is the name of the field being sorted across.

name

Is the new name for the ACROSS-TOTAL column title.

col1, col2

Are the titles of the ACROSS columns you want to include in the total.

Producing Row Totals for Horizontal (ACROSS) Sort Field Values

The following illustrates how to generate a row total for horizontal (ACROSS) sort field values. Notice that the summed values in the TOTAL TITLE COUNT column only reflect the values in the (RATING) PG and R columns. The values in the COPIES column are not included since they are not horizontal (ACROSS) sort field values.

```
TABLE FILE MOVIES
SUM COPIES BY CATEGORY
COUNT TITLE BY CATEGORY
ACROSS RATING ACROSS-TOTAL
COLUMNS PG AND R
END
```

The output is:

CATEGORY	COPIES	RATING		TOTAL
		PG	R	
ACTION	14	2	3	5
COMEDY	16	4	1	5
DRAMA	2	0	1	1
FOREIGN	5	2	3	5
MUSICALS	2	1	1	2
MYSTERY	17	2	5	7
SCI/FI	3	0	3	3

Usage Notes for ACROSS-TOTAL

- Stacking headings in ACROSS-TOTAL is not supported.
- Attempting to use ACROSS-TOTAL with other types of fields (alphanumeric, text, and dates) produces blank columns.
- In cases of multiple ACROSS columns with ACROSS-TOTAL, there are additional columns with subtotaled values.
- The results of ROW-TOTAL and ACROSS-TOTAL are the same if there is only a single

display field or single display command in the procedure.

- The maximum number of ACROSS-TOTAL components is five.
- ACROSS-TOTAL populates the ACROSSVALUE component in a StyleSheet. .

Including Section Totals and a Grand Total

Frequently, reports contain detailed information that is broken down into subsections, for which simple column and row totals may not provide adequate summaries. In these instances, it is more useful to look at subtotals for particular sections, and a grand total.

You can add the following commands to your requests to create section subtotals and grand totals:

- SUB-TOTAL and SUBTOTAL
- SUMMARIZE and RECOMPUTE (used with calculated values)
- RECAP and COMPUTE

Each command produces grand totals and/or subtotals by using different information. Subtotals produce totals every time a specified sort field value changes, and are independent of record selection criteria. You can further control when subtotals are produced by specifying WHEN criteria (see [Conditionally Displaying Summary Lines and Text](#)). You can control whether subtotals display above or below the data. For more information, see [Control Placement of Summary Lines](#). You can also suppress grand totals using the NOTOTAL command. For details, see [Suppressing Grand Totals](#).

By default, a blank line is generated before a subtotal on the report output. You can eliminate these automatic blank lines by issuing the SET DROPBLNKLIN=ON command.

i Note: When the request has a PAGE-BREAK command, the GRANDTOTAL is on a page by itself.

You can use prefix operators with SUBTOTAL, SUB-TOTAL, SUMMARIZE, and RECOMPUTE. For details, see [Manipulating Summary Values With Prefix Operators](#). In addition, you can combine different summary operations in a single request. For more information, see [Combinations of Summary Commands](#).

Using Section Totals and Grand Totals

The following request illustrates how to create a subtotal every time the department value changes. The grand total is automatically produced when you use the SUBTOTAL command.

```
TABLE FILE EMPLOYEE
SUM DED_AMT BY DED_CODE BY DEPARTMENT
BY BANK_ACCT
WHERE BANK_ACCT NE 0
WHERE DED_CODE EQ 'CITY' OR 'FED'
ON DEPARTMENT SUBTOTAL
END
```

The first and last portions of the output are:

DED_CODE	DEPARTMENT	BANK_ACCT	DED_AMT
-----	-----	-----	-----
CITY	MIS	40950036	\$14.00
		122850108	\$31.75
		163800144	\$82.70
*TOTAL DEPARTMENT MIS			\$128.45
	PRODUCTION	160633	\$7.42
		136500120	\$18.25
		819000702	\$60.20
*TOTAL DEPARTMENT PRODUCTION			\$85.87
FED	MIS	40950036	\$1,190.77
		122850108	\$2,699.80
		163800144	\$7,028.30
*TOTAL DEPARTMENT MIS			\$10,918.87
	PRODUCTION	160633	\$631.12
		136500120	\$1,552.10
		819000702	\$5,120.04
*TOTAL DEPARTMENT PRODUCTION			\$7,303.26

TOTAL	\$18,436.45
-------	-------------

Including Subtotals

You can use the SUBTOTAL and SUB-TOTAL commands to sum individual values, such as columns of numbers, each time a named sort field changes value.

- SUB-TOTAL displays a subtotal when the sort field changes value, and for any higher-level sort fields when their values change.
- SUBTOTAL displays a subtotal only when the specified sort field changes value. It does not give subtotals for higher-level fields.

Both SUB-TOTAL and SUBTOTAL produce grand totals. You can suppress grand totals using the NOTOTAL command. See [Suppressing Grand Totals](#).

The subtotal is calculated every time the sort field value changes or, if WHEN criteria are applied to the sort field, every time the WHEN conditions are met.

A BY, ACROSS, or ON phrase is required to initialize the syntax.

Create Subtotals

```
{BY|ON} fieldname {SUB-TOTAL|SUBTOTAL} [MULTILINES]
      [field1 [AND] field2...] [AS 'text'] [WHEN expression;]
```

where:

fieldname

Must be the name of a field in a sort phrase. A BY phrase can include a summary command. The number of fields to subtotal multiplied by the number of levels of subtotals counts in the number of display fields permitted for the request. For details on determining the maximum number of display fields that can be used in a request, see [Displaying Report Data](#).

SUB-TOTAL|SUBTOTAL

SUB-TOTAL displays subtotals for numeric values when the BY|ON field changes value, and for any higher-level sort fields when their values change.

SUBTOTAL displays a subtotal only when the specified sort field changes value.

MULTILINES

Suppresses the printing of a subtotal line for every sort break that has only one detail line, since the subtotal value is equal to this one value. Note that MULTI-LINES is a synonym for MULTILINES. MULTILINES is not supported with horizontal (ACROSS) sort fields.

field1, field2, ...

Denotes a list of specific fields to subtotal. This list overrides the default, which includes all numeric display fields. The list can include numeric and alphanumeric fields.

You can use the asterisk (*) wildcard character instead of a field list to indicate that all fields, numeric and alphanumeric, should be included on the summary lines.

AS 'text'

Enables you to specify a different label.

WHEN expression

Specifies the conditional display of subtotals as determined by a Boolean expression. You must end the expression with a semicolon.

Control Placement of Summary Lines

```
SET SUBTOTALS = {ABOVE|BELOW}
```

where:

ABOVE

Places summary lines above the detail lines and displays the sort field values on every detail line of the report output.

BELOW

Places summary lines below the detail lines. BELOW is the default value.

i Note: SET SUBTOTALS = ABOVE is not supported with format XLSX, EXL07, or EXL2K FORMULA.

Placing Subtotals Above the Data

The following request against the EMPLOYEE data source sums deduction amounts and gross salaries by department, deduction code, and last name. It then subtotals the deduction amounts and gross salaries for each department. The following request places the subtotals below the detail lines (the default):

```
TABLE FILE EMPLOYEE
SUM DED_AMT GROSS
BY DEPARTMENT
BY DED_CODE
  BY LAST_NAME
WHERE BANK_ACCT NE 0
WHERE DED_CODE EQ 'FICA' OR 'CITY'
  ON DEPARTMENT SUBTOTAL
  ON TABLE SET SUBTOTALS BELOW
  ON TABLE SET PAGE NOPAGE
END
```

The output is:

DEPARTMENT	DED_CODE	LAST_NAME	DED_AMT	GROSS
-----	-----	-----	-----	-----
MIS	CITY	BLACKWOOD	\$31.76	\$9,075.00
		CROSS	\$82.69	\$22,013.77
		JONES	\$14.01	\$6,099.50
	FICA	BLACKWOOD	\$2,223.37	\$9,075.00
		CROSS	\$5,788.01	\$22,013.77
		JONES	\$980.64	\$6,099.50
*TOTAL DEPARTMENT MIS			\$9,120.47	\$74,376.54
PRODUCTION	CITY	BANNING	\$7.42	\$2,475.00
		IRVING	\$60.24	\$17,094.00
		MCKNIGHT	\$18.26	\$9,129.99

FICA	BANNING	\$519.75	\$2,475.00
	IRVING	\$4,216.53	\$17,094.00
	MCKNIGHT	\$1,278.21	\$9,129.99
*TOTAL DEPARTMENT PRODUCTION		\$6,100.40	\$57,397.98
TOTAL		\$15,220.88	\$131,774.52

The following is the same request, but with the subtotals placed above the detail lines:

```
TABLE FILE EMPLOYEE
SUM DED_AMT GROSS
BY DEPARTMENT
BY DED_CODE
  BY LAST_NAME
WHERE BANK_ACCT NE 0
WHERE DED_CODE EQ 'FICA' OR 'CITY'
  ON DEPARTMENT SUBTOTAL
  ON TABLE SET SUBTOTALS ABOVE
  ON TABLE SET PAGE NOPAGE
END
```

On the output, the grand total line comes first, then the subtotal for the MIS department followed by the detail lines for the MIS department, followed by the subtotal for the PRODUCTION department and its detail lines. Note that all sort field values display on each line of the report output:

DEPARTMENT	DED_CODE	LAST_NAME	DED_AMT	GROSS
-----	-----	-----	-----	-----
TOTAL			\$15,220.88	\$131,774.52
*TOTAL DEPARTMENT MIS			\$9,120.47	\$74,376.54
MIS	CITY	BLACKWOOD	\$31.76	\$9,075.00
MIS	CITY	CROSS	\$82.69	\$22,013.77
MIS	CITY	JONES	\$14.01	\$6,099.50
MIS	FICA	BLACKWOOD	\$2,223.37	\$9,075.00
MIS	FICA	CROSS	\$5,788.01	\$22,013.77
MIS	FICA	JONES	\$980.64	\$6,099.50
*TOTAL DEPARTMENT PRODUCTION			\$6,100.40	\$57,397.98
PRODUCTION	CITY	BANNING	\$7.42	\$2,475.00
PRODUCTION	CITY	IRVING	\$60.24	\$17,094.00

PRODUCTION	CITY	MCKNIGHT	\$18.26	\$9,129.99
PRODUCTION	FICA	BANNING	\$519.75	\$2,475.00
PRODUCTION	FICA	IRVING	\$4,216.53	\$17,094.00
PRODUCTION	FICA	MCKNIGHT	\$1,278.21	\$9,129.99

Usage Notes for Subtotals

- When using a SUM or COUNT command with only one sort phrase in the request, SUB-TOTAL and SUBTOTAL produce the same result as the value of the SUM or COUNT command. However, when using a PRINT command with one sort phrase, SUBTOTAL is useful because there can be many values within a sort break.
- All SUB-TOTALs display up to and including the point where the sort break occurs, so only the innermost point of subtotalling should be requested. For instance, if the BY fields are

```
BY AREA
BY PROD_CODE
BY DATE SUB-TOTAL
```

then, when AREA changes, subtotals are displayed for DATE, PROD_CODE, and AREA on three lines (one under the other).

- If you use a WHERE TOTAL or IF TOTAL test, the display of the sort field value for the subtotal line is suppressed unless PRINTPLUS is ON. For details about using PRINTPLUS in FOCUS, see [Using PRINTPLUS](#).
- Subtotals display on the next line if the subtotal text does not fit on the line prior to the displayed field columns.
- If a report request has multiple BY phrases, with SUBTOTAL/SUMMARIZE/RECOMPUTE/SUB-TOTAL at several levels, and MULTILINES or MULTI-LINES is specified at any one of those levels, it applies to all levels.

i Note: ON BYfield SUBFOOT applies only to the level specified.

Generating Subtotals

The following request illustrates how to create a subtotal for SALES every time the country value changes.

```
TABLE FILE CAR
SUM AVE.MPG AND SALES AND AVE.RETAIL_COST
BY COUNTRY SUB-TOTAL SALES
BY BODYTYPE
END
```

The output is:

COUNTRY	BODYTYPE	AVE MPG	SALES	AVE RETAIL_COST
-----	-----	----	-----	-----
ENGLAND	CONVERTIBLE	16	0	8,878
	HARDTOP	25	0	5,100
	SEDAN	10	12000	15,671
*TOTAL ENGLAND			12000	
FRANCE	SEDAN	21	0	5,610
*TOTAL FRANCE			0	
ITALY	COUPE	11	12400	19,160
	ROADSTER	21	13000	6,820
	SEDAN	21	4800	5,925
*TOTAL ITALY				
JAPAN	SEDAN	14	78030	3,239
*TOTAL JAPAN			78030	
W GERMANY	SEDAN	20	88190	9,247
*TOTAL W GERMANY			88190	
TOTAL			208420	

Comparing SUB-TOTAL and SUBTOTAL

The following request illustrates how to create a subtotal for the numeric fields DED_AMT and GROSS when the department value changes, and for the higher-level sort field (DED_CODE) when its value changes.

```
TABLE FILE EMPLOYEE
SUM DED_AMT GROSS BY DED_CODE BY DEPARTMENT
BY BANK_ACCT
WHERE BANK_ACCT NE 0
ON DEPARTMENT SUB-TOTAL
END
```

If you use SUBTOTAL instead of SUB-TOTAL, the totals for DED_AMT and GROSS display only when the DEPARTMENT value changes.

The first portion of the output is:

DED_CODE	DEPARTMENT	BANK_ACCT	DED_AMT	GROSS
-----	-----	-----	-----	-----
CITY	MIS	40950036	\$14.00	\$6,099.50
		122850108	\$31.75	\$9,075.00
		163800144	\$82.70	\$22,013.75
*TOTAL DEPARTMENT MIS			\$128.45	\$37,188.25
	PRODUCTION	160633	\$7.42	\$2,475.00
		136500120	\$18.25	\$9,130.00
		819000702	\$60.20	\$17,094.00
*TOTAL DEPARTMENT PRODUCTION			\$85.87	\$28,699.00
*TOTAL DED_CODE CITY			\$214.32	\$65,887.25

The last portion of the output is:

DED_CODE	DEPARTMENT	BANK_ACCT	DED_AMT	GROSS
-----	-----	-----	-----	-----
STAT	MIS	40950036	\$196.13	\$6,099.50
		122850108	\$444.65	\$9,075.00
		163800144	\$1,157.60	\$22,013.75
*TOTAL DEPARTMENT MIS			\$1,798.38	\$37,188.25

PRODUCTION	160633	\$103.95	\$2,475.00
	136500120	\$255.65	\$9,130.00
	819000702	\$843.32	\$17,094.00
*TOTAL DEPARTMENT PRODUCTION		\$1,202.92	\$28,699.00
*TOTAL DED_CODE STAT		\$3,001.30	\$65,887.25
TOTAL		\$41,521.18	\$461,210.75

Recalculating Values for Subtotal Rows

You can use the SUMMARIZE and RECOMPUTE commands instead of SUB-TOTAL and SUBTOTAL to recalculate the result of a COMPUTE command. SUMMARIZE is similar to SUB-TOTAL in that it recomputes values at every sort break. RECOMPUTE is similar to SUBTOTAL in that it recalculates only at the specified sort break.

SUMMARIZE recomputes grand totals for the entire report. If you wish to suppress grand totals, you can include the NOTOTAL command in your request. See [Suppressing Grand Totals](#).

Subtotal Calculated Values

```
{BY|ON} fieldname {SUMMARIZE|RECOMPUTE} [MULTILINES]
    [field1 [AND] field2...] [AS 'text'] [WHEN expression;]
```

where:

fieldname

Must be the name of a field in a sort phrase. A BY phrase can include a summary command. The number of fields to summarize multiplied by the number of levels of summary commands counts in the number of display fields for the request. For details on determining the maximum number of display fields that can be used in a request, see [Displaying Report Data](#).

SUMMARIZE

Recomputes values at every sort break.

RECOMPUTE

Recalculates values only at the specified sort break.

MULTILINES

Suppresses the printing of a subtotal line for every sort break that has only one detail line, since the subtotal value is equal to this one value. Note that MULTI-LINES is a synonym for MULTILINES. MULTILINES is not supported with horizontal (ACROSS) sort fields.

You can also suppress grand totals using the NOTOTAL command, as described in [Suppressing Grand Totals](#).

AS 'text'

Enables you to specify a different label.

field1, field2, ...

Denotes a list of specific fields to be subtotaled after the RECOMPUTE or SUMMARIZE. This list overrides the default, which includes all numeric display fields.

You can use the asterisk (*) wildcard character instead of a field list to indicate that all fields, numeric and alphanumeric, should be included on the summary lines. You can either use the asterisk to display all columns or reference the specific columns, numeric and alphanumeric, you want to display.

WHEN expression

Specifies the conditional display of subtotals based on a Boolean expression. You must end the expression with a semicolon.

You may also generate subtotals for the recalculated values with the ON TABLE command. Use the following syntax:

```
ON TABLE SUMMARIZE
```

Using SUMMARIZE

The following request illustrates the use of SUMMARIZE to recalculate DG_RATIO at the specified sort break, DEPARTMENT, and for the higher-level sort break, PAY_DATE:

```
TABLE FILE EMPLOYEE
SUM GROSS DED_AMT AND COMPUTE
DG_RATIO/F4.2=DED_AMT/GROSS;
BY HIGHEST PAY_DATE BY DEPARTMENT
BY BANK_ACCT
WHERE BANK_ACCT NE 0
ON DEPARTMENT SUMMARIZE
END
```

The first portion of the output is:

PAY_DATE RATIO	DEPARTMENT	BANK_ACCT	GROSS	DED_AMT	DG_
-----	-----	-----	-----	-----	-----
-					
82/08/31 .47	MIS	40950036	\$1,540.00	\$725.34	
.69		122850108	\$1,815.00	\$1,261.40	
.74		163800144	\$2,255.00	\$1,668.69	
*TOTAL .65	DEPARTMENT MIS		\$5,610.00	\$3,655.43	
.58	PRODUCTION	160633	\$2,475.00	\$1,427.24	
.39		136500120	\$1,342.00	\$522.28	
.78		819000702	\$2,238.50	\$1,746.03	
*TOTAL .61	DEPARTMENT PRODUCTION		\$6,055.50	\$3,695.55	
*TOTAL .63	PAY_DATE 82/08/31		\$11,665.50	\$7,350.98	

The last portion of the output is:

PAY_DATE RATIO	DEPARTMENT	BANK_ACCT	GROSS	DED_AMT	DG_
-----	-----	-----	-----	-----	-----
-					
82/01/29 .61	PRODUCTION	819000702	\$2,035.00	\$1,241.33	
*TOTAL DEPARTMENT PRODUCTION .61			\$2,035.00	\$1,241.33	
*TOTAL PAY_DATE 82/01/29 .63			\$4,182.75	\$2,648.12	
81/12/31 .66	MIS	163800144	\$2,147.75	\$1,406.79	
*TOTAL DEPARTMENT MIS .66			\$2,147.75	\$1,406.79	
*TOTAL PAY_DATE 81/12/31 .66			\$2,147.75	\$1,406.79	
81/11/30 .66	MIS	163800144	\$2,147.75	\$1,406.79	
*TOTAL DEPARTMENT MIS .66			\$2,147.75	\$1,406.79	
*TOTAL PAY_DATE 81/11/30 .66			\$2,147.75	\$1,406.79	
TOTAL .63			\$65,887.25	\$41,521.18	



Tip: If you use SUB-TOTAL or SUBTOTAL rather than SUMMARIZE, the values of DG_RATIO are added.

Using RECOMPUTE

The following request illustrates the use of RECOMPUTE to recalculate DG_RATIO only at the specified sort break, DEPARTMENT.

```
TABLE FILE EMPLOYEE
SUM GROSS DED_AMT AND COMPUTE
```

```

DG_RATIO/F4.2=DED_AMT/GROSS;
BY HIGHEST PAY_DATE BY DEPARTMENT
BY BANK_ACCT
WHERE BANK_ACCT NE 0
ON DEPARTMENT RECOMPUTE
END

```

The first portion of the output is:

PAY_DATE RATIO	DEPARTMENT	BANK_ACCT	GROSS	DED_AMT	DG_
-----	-----	-----	-----	-----	-----
-					
82/08/31 .47	MIS	40950036	\$1,540.00	\$725.34	
.69		122850108	\$1,815.00	\$1,261.40	
.74		163800144	\$2,255.00	\$1,668.69	
*TOTAL DEPARTMENT MIS .65			\$5,610.00	\$3,655.43	
.58	PRODUCTION	160633	\$2,475.00	\$1,427.24	
.39		136500120	\$1,342.00	\$522.28	
.78		819000702	\$2,238.50	\$1,746.03	
*TOTAL DEPARTMENT PRODUCTION .61			\$6,055.50	\$3,695.55	
82/07/30 .47	MIS	40950036	\$1,540.00	\$725.34	
.69		122850108	\$1,815.00	\$1,261.40	

The last portion of the output is:

PAY_DATE RATIO	DEPARTMENT	BANK_ACCT	GROSS	DED_AMT	DG_
-----	-----	-----	-----	-----	-----
-					
82/01/29	MIS	163800144	\$2,147.75	\$1,406.79	

.66				
*TOTAL DEPARTMENT MIS			\$2,147.75	\$1,406.79
.66				
	PRODUCTION	819000702	\$2,035.00	\$1,241.33
.61				
*TOTAL DEPARTMENT PRODUCTION			\$2,035.00	\$1,241.33
.61				
81/12/31	MIS	163800144	\$2,147.75	\$1,406.79
.66				
*TOTAL DEPARTMENT MIS			\$2,147.75	\$1,406.79
.66				
81/11/30	MIS	163800144	\$2,147.75	\$1,406.79
.66				
*TOTAL DEPARTMENT MIS			\$2,147.75	\$1,406.79
.66				
TOTAL			\$65,887.25	\$41,521.18
.63				

Summarizing Alphanumeric Columns

By default, subtotals (using the SUBTOTAL and SUB-TOTAL commands) and recalculations (using the RECOMPUTE and SUMMARIZE commands) only display values for numeric report columns. However, you can include alphanumeric columns on these summary lines by either specifying the columns you want to display on the summary lines or by using the asterisk wildcard character to display all fields on the summary lines.

The alphanumeric value displayed on a SUBTOTAL or SUB-TOTAL line is either the first, minimum, maximum, or last alphanumeric value within the sort group, depending on the value of the SUMPREFIX parameter. On a RECOMPUTE or SUMMARIZE line, alphanumeric values are recalculated using the summary values for that line.

Include All Columns on Summary Lines

```
ON sortfieldsummarycommand *
```

where:

sortfield

Is the sort field for which a change in value triggers the summary line.

summarycommand

Is SUBTOTAL, SUB-TOTAL, RECOMPUTE, or SUMMARIZE.

*

Indicates that all fields, numeric and alphanumeric, should be included on the summary lines. You can either use the asterisk to display all columns or reference the specific columns you want to display.

Including Alphanumeric Fields on Summary Lines

The following request against the GGSALES data source computes the alphanumeric equivalents of the DOLLARS and UNITS fields, creates an alphanumeric version of the formula for the ratio between DOLLARS and UNITS, and computes the numeric ratio between DOLLARS and UNITS. The RECOMPUTE * command recomputes all values on a change of value for the state sort field:

```
SET SUMPREFIX=FST
TABLE FILE GGSALES
SUM PRODUCT DOLLARS/I8M AS 'Dollars' IN 22 UNITS AS 'Units'
COMPUTE Formula/A19 = EDIT(DOLLARS) | '/' | EDIT(UNITS) | '=';
COMPUTE Ratio/F8     = DOLLARS/UNITS;
BY ST
BY CATEGORY NOPRINT
WHERE ST EQ 'CA' OR 'IL'
ON ST RECOMPUTE *
ON TABLE SET PAGE NOPAGE
END
```

On the output, the alphanumeric formula is recomputed using the summed numeric fields. However, the product value is taken from the first product within each sort value, as that field is not recomputed and SUMPREFIX=FST:

State Ratio	Product	Dollars	Units	Formula	
-----	-----	-----	-----	-----	-----
-					
CA	Capuccino	\$2,957,852	237246	02957852/00237246=	
12					
	Biscotti	\$2,770,508	222844	02770508/00222844=	
12					
	Coffee Grinder	\$1,935,863	152276	01935863/00152276=	
13					
*TOTAL	CA				
	Capuccino	\$7,664,223	612366	07664223/00612366=	
13					
IL	Espresso	\$1,398,779	109581	01398779/00109581=	
13					
	Biscotti	\$1,561,904	120976	01561904/00120976=	
13					
	Coffee Grinder	\$1,050,243	83541	01050243/00083541=	
13					
*TOTAL	IL				
	Espresso	\$4,010,926	314098	04010926/00314098=	
13					
TOTAL	Capuccino	\$11,675,149	926464	11675149/00926464=	
13					

Note that if the SUBTOTAL summary command had been used, the formula would not have been recomputed and would have displayed the values from the first line within each sort group.

Usage Notes for Summarizing Alphanumeric Columns

- Date fields and numeric and alphanumeric fields with date formatting options are not included on summary lines.
- Column total lines follow the same rules as summary lines.
- Summary values for ACROSS sort fields are supported.

Manipulating Summary Values With Prefix Operators

You can use the SUBTOTAL, SUB-TOTAL, RECOMPUTE, and SUMMARIZE commands at the ON TABLE level to specify the type of summary operation to use to produce the grand total line on the report.

In addition, prefix operators can be used with the summary options SUBTOTAL, SUB-TOTAL, RECOMPUTE, and SUMMARIZE at both the sort break and grand total levels. If the same field was aggregated using multiple prefix operators in the SUM command, you can use the prefix operator along with the field name to differentiate between the fields with multiple operators in the summary command.

Prefix operations on summary lines are performed on the retrieved, selected, and summed values that become the detail lines in the report. Unlike field-based prefix operations, they are not performed on each incoming record.

Each type of summary has its own purpose, and handles the prefix operators appropriately for the type of summary information to be displayed. For example, using AVE. at a sort field break produces the average within the sort group.

Alphanumeric fields can also be displayed on summary lines. In order to do this, you must either explicitly list the alphanumeric field name on the summary command, or use the asterisk (*) wildcard to display all fields.

Different operations from two ON phrases for the same sort break display on the same summary line, and allow a mixture of operations on summary lines. The grand total line populates all fields populated by any summary command, even fields that are not specified in the grand total command.

If the same field is referenced in more than one ON phrase for the same sort break, the last function specified is applied.

The following prefix operators are supported for numeric fields:

- ASQ.
- AVE.
- CNT.
- FST.
- LST.
- MAX.
- MIN.
- SUM.

The following prefix operators are supported for alphanumeric fields:

- FST.
- LST.
- MAX.
- MIN.
- SUM. (means LST. if SUMPREFIX=LST or FST. if SUMPREFIX=FST)

Use Prefix Operators With Summary Values

```
{BY|ON} breakfield [AS 'text1'] sumoption [MULTILINES]
    [pref. ] [*|[field1 [[pref2. ] field2 ...]]]
    [AS 'text2'] [WHEN expression;]
```

To replace the default grand total, use the following syntax

```
ON TABLE sumoption [pref. ][field1 [[pref2. ]field2 ...]] [AS 'text2']
```

where:

breakfield

Is the sort field whose change in value triggers the summary operation. A BY phrase can include a summary command. When the value of the sort field changes, it triggers the summary operation.

sumoption

Can be one of the following: SUBTOTAL, SUB-TOTAL, RECOMPUTE, or SUMMARIZE.

'text1'

Is the column heading to use for the break field on the report output.

MULTILINES

Suppresses the printing of a summary line for every sort break that has only one detail line. Note that MULTILINES suppresses the summary line even if a prefix operator is used to specify a different operation for the summary line. MULTI-LINES is a synonym for MULTILINES. MULTILINES is not supported with horizontal (ACROSS) sort fields.

pref.

Is a prefix operator. When specified without a field list, the prefix operator is applied to every numeric column in the report output and every numeric column is populated with values on the summary row.

*

Includes all display fields on the summary line. If a prefix operator is specified, it is applied to all fields. If the prefix operator is not supported with alphanumeric fields, alphanumeric fields are not included on the summary line.

[field1 [field2 ... fieldn]]

Produces the type of summary specified by *sumoption* for the listed fields. If no field names are listed, the summary is produced for every numeric column in the report output.

pref. field1 [field2 ... fieldn] [pref2. fieldm ...]

The first prefix operator is applied to field1 through fieldn. The second prefix operator is applied to fieldm. Only the fields specified are populated with values on the summary row. Each prefix operator must be separated by a blank space from the following field name. For example:

BY STORE_CODE SUMMARIZE AVE.	UNIT_SOLD RETURNS CNT.	DAMAGED
------------------------------	------------------------	---------

↓ 1 Space
↓ 1 Space

'text2'

Is the text that prints on the left of the summary row.

expression

Is an expression that determines whether the summary operation is performed at each break.

Usage Notes for Summary Prefix Operators

- COLUMN-TOTAL does not support prefix operators.
- Prefix operators PCT., RPCT., AND TOT. are not supported.
- Double prefix operators (such as PCT.CNT.) are not supported.
- When an ACROSS field is used in the request, the same field name displays over multiple columns (ACROSS groups) in the report output. A prefix operator applied to such a field on a summary line is applied to all of those columns.
- The SUM. prefix operator produces the same summary values as a summary phrase with no prefix operator.
- SUMMARIZE and RECOMPUTE apply the calculations defined in the associated COMPUTE command to the summary values. Therefore, in order to perform the necessary calculations, the SUMMARIZE or RECOMPUTE command must calculate all of the fields referenced in the COMPUTE command.
- If the same field is referenced by more than one summary operation with different prefix operators at each level, the default grand total (one produced without an ON TABLE *summaryoption* command) applies the operation specified by the first operator used in the report request (the left-most sort field in the output).

Using Prefix Operators With SUBTOTAL

The following example uses prefix operators to calculate the:

- Average list price by rating.
- Sum copies by category within the rating field.

Notice that the subtotal row for each rating contains a value only in the LISTPR column, and the subtotal row for each category contains a value only in the COPIES column. The grand total line contains values only for the columns that were subtotaled. Note the blank space between each prefix operator and the field name that follows it:

```
TABLE FILE MOVIES
PRINT COPIES LISTPR WHOLESALPR TITLE/A23
  BY RATING
  BY CATEGORY
WHERE CATEGORY EQ 'CHILDREN' OR 'CLASSIC'
WHERE RATING EQ 'G' OR 'NR'
ON RATING SUBTOTAL AVE. LISTPR AS '*Ave: '
ON CATEGORY SUBTOTAL SUM. COPIES AS '*Sum: '
END
```

The output is:

RATING	CATEGORY	COPIES	LISTPR	WHOLESALPR	TITLE
-----	-----	-----	-----	-----	-----
G	CHILDREN	2	44.95	29.99	SHAGGY DOG, THE
		2	29.95	12.50	ALICE IN WONDERLAND
		3	26.99	12.00	BAMBI
*Sum:	CHILDREN	7			
	CLASSIC	3	89.95	40.99	GONE WITH THE WIND
*Sum:	CLASSIC	3			
*Ave:	G		47.96		
NR	CHILDREN	1	19.95	10.00	SMURFS, THE
		1	19.95	9.75	SCOOBY-DOO-A DOG IN THE
		1	14.95	7.65	SESAME STREET-BEDTIME S
		1	14.98	7.99	ROMPER ROOM-ASK MISS MO
		1	29.95	15.99	SLEEPING BEAUTY
*Sum:	CHILDREN	5			
	CLASSIC	1	24.98	14.99	EAST OF EDEN
		3	39.99	20.00	CITIZEN KANE
		1	29.95	15.99	CYRANO DE BERGERAC
		1	19.99	10.95	MARTY

		2	19.99	10.95	MALTESE FALCON, THE
		2	19.95	9.99	ON THE WATERFRONT
		2	89.99	40.99	MUTINY ON THE BOUNTY
		2	19.99	10.95	PHILADELPHIA STORY, THE
		2	19.98	10.99	CAT ON A HOT TIN ROOF
		2	29.95	15.00	CASABLANCA
*Sum:	CLASSIC	18			
*Ave:	NR		27.64		
TOTAL		33	31.91		

Using SUBTOTAL at the Sort Break and Grand Total Levels

The following example adds the ON TABLE SUBTOTAL command to the request in the previous example ([Using Prefix Operators With SUBTOTAL](#)) at the sort break level to calculate the minimum number of copies and maximum list price on the grand total line for the entire report:

```
TABLE FILE MOVIES
PRINT COPIES LISTPR WHOLESALPR TITLE/A23
  BY RATING
  BY CATEGORY
  WHERE CATEGORY EQ 'CHILDREN' OR 'CLASSIC'
  WHERE RATING EQ 'G' OR 'NR'
  ON RATING SUBTOTAL AVE. LISTPR AS '*Ave: '
  ON CATEGORY SUBTOTAL SUM. COPIES AS '*Sum: '
  ON TABLE SUBTOTAL MIN. COPIES MAX. LISTPR
END
```

The output is exactly the same as in the previous request, except for the grand total line:

RATING	CATEGORY	COPIES	LISTPR	WHOLESALPR	TITLE
-----	-----	-----	-----	-----	-----
G	CHILDREN	2	44.95	29.99	SHAGGY DOG, THE
		2	29.95	12.50	ALICE IN WONDERLAND
		3	26.99	12.00	BAMBI

*Sum:	CHILDREN	7			
	CLASSIC	3	89.95	40.99	GONE WITH THE WIND
*Sum:	CLASSIC	3			
*Ave:	G		47.96		
NR	CHILDREN	1	19.95	10.00	SMURFS, THE
		1	19.95	9.75	SCOOBY-DOO-A DOG IN THE
		1	14.95	7.65	SESAME STREET-BEDTIME S
		1	14.98	7.99	ROMPER ROOM-ASK MISS MO
		1	29.95	15.99	SLEEPING BEAUTY
*Sum:	CHILDREN	5			
	CLASSIC	1	24.98	14.99	EAST OF EDEN
		3	39.99	20.00	CITIZEN KANE
		1	29.95	15.99	CYRANO DE BERGERAC
		1	19.99	10.95	MARTY
		2	19.99	10.95	MALTESE FALCON, THE
		2	19.95	9.99	ON THE WATERFRONT
		2	89.99	40.99	MUTINY ON THE BOUNTY
		2	19.99	10.95	PHILADELPHIA STORY, THE
		2	19.98	10.99	CAT ON A HOT TIN ROOF
		2	29.95	15.00	CASABLANCA
*Sum:	CLASSIC	18			
*Ave:	NR		27.64		
TOTAL		1	89.99		

Differentiating Between Fields With Multiple Prefix Operators

The following request uses both the MAX. and MIN. prefix operators with the UNITS field. On the summary commands, these are differentiated by referencing them as MAX.UNITS and MIN.UNITS.

```
TABLE FILE GGSALES
  SUM MAX.UNITS MIN.UNITS
  BY REGION
```

```

BY ST
ON REGION RECOMPUTE MAX. MAX.UNITS MIN. MIN.UNITS
WHERE DATE GE 19971001
WHERE REGION EQ 'West' OR 'Northeast'
ON TABLE RECOMPUTE MIN. MAX.UNITS MAX. MIN.UNITS
ON TABLE SET PAGE NOPAGE
END

```

On the report output, the summary for each region displays the maximum of the state maximum values and the minimum of the state minimum values. The summary for the entire report displays the minimum of the state maximum values and the maximum of the state minimum values. The report output is shown in the following image:

<u>Region</u>	<u>State</u>	<u>MAX Unit Sales</u>	<u>MIN Unit Sales</u>
Northeast	CT	1770	101
	MA	1780	146
	NY	1797	73
*TOTAL Northeast		1797	73
West	CA	1794	72
	WA	1787	257
*TOTAL West		1794	72
TOTAL		1770	257

Displaying an Alphanumeric Field on a Summary Line

The following request displays the sum of the list price field and the minimum value of the director field by rating:

```

TABLE FILE MOVIES
PRINT COPIES LISTPR WHOLESALPR DIRECTOR
BY RATING
BY CATEGORY
WHERE CATEGORY EQ 'CHILDREN' OR 'CLASSIC'
WHERE RATING EQ 'G' OR 'NR'
WHERE DIRECTOR NE ' '
ON RATING SUBTOTAL SUM. LISTPR MIN. DIRECTOR AS '*A/N:'
END

```

The output is:

RATING	CATEGORY	COPIES	LISTPR	WHOLESALPR	DIRECTOR
G	CHILDREN	2	44.95	29.99	BARTON C.
		2	29.95	12.50	GEROMINI
		3	26.99	12.00	DISNEY W.
	CLASSIC	3	89.95	40.99	FLEMING V
*A/N: G		191.84		BARTON C.	
NR	CHILDREN	1	29.95	15.99	DISNEY W.
		1	24.98	14.99	KAZAN E.
	CLASSIC	3	39.99	20.00	WELLES O.
		1	29.95	15.99	GORDON M.
		1	19.99	10.95	MANN D.
		2	19.99	10.95	HUSTON J.
		2	19.95	9.99	KAZAN E.
		2	89.99	40.99	MILESTONE L.
		2	19.99	10.95	CUKOR G.
		2	19.98	10.99	BROOKS R.
		2	29.95	15.00	CURTIZ M.
		*A/N: NR		344.71	
TOTAL		536.55		BARTON C.	

Displaying All Fields on a Summary Line

The following request displays the sum of every display field on the subtotal line. The director field is alphanumeric, so the last value displays:

```

TABLE FILE MOVIES
PRINT COPIES LISTPR WHOLESALPR DIRECTOR
BY RATING
BY CATEGORY
WHERE CATEGORY EQ 'CHILDREN' OR 'CLASSIC'
WHERE RATING EQ 'G' OR 'NR'
WHERE DIRECTOR NE ' '
ON RATING SUBTOTAL SUM. * AS '*All: '
END

```

The output is:

RATING	CATEGORY	COPIES	LISTPR	WHOLESALPR	DIRECTOR
G	CHILDREN	2	44.95	29.99	BARTON C.
		2	29.95	12.50	GEROMINI
		3	26.99	12.00	DISNEY W.
	CLASSIC	3	89.95	40.99	FLEMING V
*All:	G	10	191.84	95.48	FLEMING V
NR	CHILDREN CLASSIC	1	29.95	15.99	DISNEY W.
		1	24.98	14.99	KAZAN E.
		3	39.99	20.00	WELLES O.
		1	29.95	15.99	GORDON M.
		1	19.99	10.95	MANN D.
		2	19.99	10.95	HUSTON J.
		2	19.95	9.99	KAZAN E.
		2	89.99	40.99	MILESTONE L.
		2	19.99	10.95	CUKOR G.
		2	19.98	10.99	BROOKS R.
		2	29.95	15.00	CURTIZ M.
		*All:	NR	19	344.71
TOTAL		29	536.55	272.27	CURTIZ M.

Controlling Summary Line Processing

When processing summary lines, you can control whether SUBTOTAL and RECOMPUTE commands are propagated to the grand total row of a report.

If the summary line contains fields with and without prefix operators, those fields without prefix operators are processed as though they were specified with the operator SUM.

The function of the SET SUMMARYLINES command is to make the processing of SUBTOTAL, SUB-TOTAL, SUMMARIZE, and RECOMPUTE on the grand total line consistent with how they work for sort field breaks. The setting that invokes this type of processing is SET SUMMARYLINES=EXPLICIT.

When SUBTOTAL and RECOMPUTE are used at a sort break level, they do not propagate to other sort breaks. SUB-TOTAL and SUMMARIZE propagate to all higher-level sort breaks.

The grand total can be considered the highest level sort field in a request. However, by default, all of the summary options, not just SUB-TOTAL and SUMMARIZE, propagate to the grand total level.

The SET SUMMARYLINES=EXPLICIT command prevents the propagation of SUBTOTAL and RECOMPUTE to the grand total. In addition, if all summary commands in the request specify field lists, only the specified fields are aggregated and displayed on the grand total line.

When SUBTOTAL and RECOMPUTE are the only summary commands used in the request, a grand total line is produced only if it is explicitly specified in the request using the ON TABLE SUBTOTAL/SUB-TOTAL/RECOMPUTE/SUMMARIZE phrase. If the ON TABLE phrase specifies a field list, only those fields are aggregated and displayed.

Note that you can always suppress the grand total line using the ON TABLE NOTOTAL command in the request.

Control Summary Line Processing

```
SET SUMMARYLINES = {NEW|OLD|EXPLICIT}
```

where:

NEW

Propagates all summary operations to the grand total line. Fields listed in a summary command are populated only on summary lines created by that summary command and on summary lines created by propagation of that summary command. NEW is the default value.

The alphanumeric value displayed on a SUBTOTAL or SUB-TOTAL line is either the first or last alphanumeric value within the sort group, depending on the value of the SUMPREFIX parameter. On a RECOMPUTE or SUMMARIZE line, alphanumeric values are recalculated using the summary values for that line.

OLD

This value is no longer supported and is processed as NEW.

EXPLICIT

Does not propagate SUBTOTAL and RECOMPUTE to the grand total line. Fields listed in a summary command are populated only on summary lines created by that summary command and on summary lines created by propagation of that summary command.

i Note: This command is not supported in a request using the ON TABLE SET syntax.

Usage Notes for SET SUMMARYLINES

- SET SUMMARYLINES is not supported within a TABLE request (ON TABLE).
- If COLUMN-TOTAL is specified in the request, all numeric fields are totaled on the grand total line unless the COLUMN-TOTAL phrase lists specific fields. If the COLUMN-TOTAL phrase lists specific fields, those fields and any fields propagated by SUB-TOTAL or SUMMARIZE commands are totaled.
- A summary command with a list of field names populates only those columns on the associated summary line.

For example:

```
TABLE FILE MOVIES
PRINT COPIES LISTPR WHOLESALEPR
  BY RATING
  BY CATEGORY
WHERE CATEGORY EQ 'CHILDREN'
WHERE RATING   EQ 'G'
ON RATING     SUBTOTAL LISTPR AS '*LIST'
ON CATEGORY   SUBTOTAL COPIES AS '*COPY'
END
```

The output has subtotals for COPIES on the CATEGORY sort break and for LISTPR on the RATING sort break. Both columns are populated on the grand total line. WHOLESALEPR is not referenced in either SUBTOTAL command and, therefore, is not on any summary line:

RATING	CATEGORY	COPIES	LISTPR	WHOLESALEPR
-----	-----	-----	-----	-----
G	CHILDREN	2	44.95	29.99
		2	29.95	12.50
		3	26.99	12.00
*COPY	CHILDREN	7		
*LIST	G		101.89	
TOTAL		7	101.89	

Using SET SUMMARYLINES With SUBTOTAL

The following request using the MOVIES data source has a sort break for CATEGORY that subtotals the COPIES field and a sort break for RATING that subtotals the LISTPR field:

```
TABLE FILE MOVIES
SUM COPIES LISTPR WHOLESALEPR
BY RATING
BY CATEGORY
WHERE CATEGORY EQ 'CHILDREN'
WHERE RATING EQ 'G'
ON RATING SUBTOTAL COPIES
ON CATEGORY SUBTOTAL LISTPR
END
```

Running the request with SUMMARYLINES=NEW subtotals COPIES only for the RATING sort break and subtotals LISTPR only for the CATEGORY sort break but propagates both to the grand total line:

RATING	CATEGORY	COPIES	LISTPR	WHOLESALEPR
-----	-----	-----	-----	-----
G	CHILDREN	7	101.89	54.49
*TOTAL	CHILDREN		101.89	
*TOTAL	G	7		

TOTAL	7	101.89
-------	---	--------

Running the request with SUMMARYLINES=EXPLICIT subtotals COPIES only for the RATING sort break and subtotals LISTPR only for the CATEGORY sort break. It does not produce a grand total line:

RATING	CATEGORY	COPIES	LISTPR	WHOLESALEPR
-----	-----	-----	-----	-----
G	CHILDREN	7	101.89	54.49
*TOTAL CHILDREN			101.89	
*TOTAL G		7		

Adding the phrase ON TABLE SUBTOTAL WHOLESALEPR with SUMMARYLINES=EXPLICIT produces a grand total line with the WHOLESALEPR field subtotaled:

RATING	CATEGORY	COPIES	LISTPR	WHOLESALEPR
-----	-----	-----	-----	-----
G	CHILDREN	7	101.89	54.49
*TOTAL CHILDREN			101.89	
*TOTAL G		7		
TOTAL				54.49

Using COLUMN-TOTAL With SET SUMMARYLINES=EXPLICIT

The following request using the MOVIES data source has a sort break for CATEGORY for which subtotals the COPIES field and a sort break for RATING that subtotals the LISTPR field. It also has an ON TABLE COLUMN-TOTAL phrase:

```
SET SUMMARYLINES=EXPLICIT
TABLE FILE MOVIES
SUM COPIES LISTPR WHOLESALEPR
BY RATING
```

```

BY CATEGORY
WHERE CATEGORY EQ 'CHILDREN'
WHERE RATING    EQ 'G'
ON RATING SUBTOTAL COPIES
ON CATEGORY SUBTOTAL LISTPR
ON TABLE COLUMN-TOTAL
END

```

The grand total line displays a column total for all numeric columns because of the ON TABLE COLUMN-TOTAL phrase:

RATING	CATEGORY	COPIES	LISTPR	WHOLESALEPR
-----	-----	-----	-----	-----
G	CHILDREN	7	101.89	54.49
*TOTAL CHILDREN			101.89	
*TOTAL G		7		
TOTAL		7	101.89	54.49

The following request has an ON TABLE SUBTOTAL WHOLESALEPR command. It also has an ON TABLE COLUMN-TOTAL phrase:

```

SET SUMMARYLINES=EXPLICIT
TABLE FILE MOVIES
SUM COPIES LISTPR WHOLESALEPR
BY RATING
BY CATEGORY
WHERE CATEGORY EQ 'CHILDREN'
WHERE RATING    EQ 'G'
ON RATING SUBTOTAL COPIES
ON CATEGORY SUBTOTAL LISTPR
ON TABLE SUBTOTAL WHOLESALEPR
ON TABLE COLUMN-TOTAL
END

```

The grand total line displays a column total only for the WHOLESALEPR column because of the ON TABLE SUBTOTAL command:

RATING	CATEGORY	COPIES	LISTPR	WHOLESALEPR
-----	-----	-----	-----	-----
G	CHILDREN	7	101.89	54.49

```

*TOTAL CHILDREN          101.89
*TOTAL G                  7

TOTAL                    54.49

```

Using SUB-TOTAL instead of SUBTOTAL causes COPIES and LISTPR to be aggregated on the grand total line. WHOLESALPR is totaled because it is listed in the COLUMN-TOTAL phrase. The subtotal for LISTPR propagates to the RATING sort break as well as to the grand total:

```

SET SUMMARYLINES=EXPLICIT
TABLE FILE MOVIES
SUM COPIES LISTPR WHOLESALPR
BY RATING
BY CATEGORY
WHERE CATEGORY EQ 'CHILDREN'
WHERE RATING EQ 'G'
ON RATING SUB-TOTAL COPIES
ON CATEGORY SUB-TOTAL LISTPR
ON TABLE COLUMN-TOTAL WHOLESALPR
END

```

The output is:

```

RATING  CATEGORY  COPIES  LISTPR  WHOLESALPR
-----  -
G        CHILDREN    7    101.89    54.49

*TOTAL CHILDREN          101.89
*TOTAL G                  7    101.89

TOTAL                    7    101.89    54.49

```

Using Prefix Operators With Calculated Values

If a request includes the RECOMPUTE or SUMMARIZE command, the expression specified in the associated COMPUTE command is applied using values from the summary line. The columns used to recompute the expression can have prefix operators. The recomputed column, regardless of the prefix operator specified for it, applies these input values to the

expression specified in the COMPUTE command. Therefore, any supported prefix operator can be specified for the recomputed report column without affecting the calculated value.

All fields used in the COMPUTE command must be displayed by the RECOMPUTE or SUMMARIZE command in order to be populated. If any field used in the expression is not populated, the calculated value returned for the expression is unpredictable.

Using Prefix Operators With RECOMPUTE

The first request creates a calculated field named DIFF, which is the difference between DOLLARS and BUDDOLLARS. This value is then recomputed for each region, without using prefix operators.

```
TABLE FILE GGSALES
SUM UNITS DOLLARS BUDDOLLARS
AND COMPUTE DIFF/I10 = DOLLARS-BUDDOLLARS;
  BY REGION
  BY CATEGORY
  WHERE CATEGORY EQ 'Food' OR 'Coffee'
  WHERE REGION EQ 'West' OR 'Midwest'
  ON REGION RECOMPUTE
END
```

The recomputed value is the difference between the totals for DOLLARS and BUDDOLLARS.

Region	Category	Unit Sales	Dollar Sales	Budget Dollars	DIFF
Midwest	Coffee	332777	4178513	4086032	-
92481	Food	341414	4338271	4220721	-
117550					
*TOTAL Midwest		674191	8516784	8306753	-
210031					
West	Coffee	356763	4473517	4523963	-
50446	Food	340234	4202337	4183244	-
19093					
*TOTAL West		696997	8675854	8707207	-

31353

TOTAL	1371188	17192638	17013960
178678			

The following request uses prefix operators in the RECOMPUTE command to calculate the maximum DOLLARS and the minimum BUDDOLLARS and then recompute DIFF. No matter which prefix operator we specify for DIFF, it is calculated as the difference between the values in the DOLLARS and BUDDOLLARS columns. If any of the fields used in the calculation (DOLLARS, BUDDOLLARS, and DIFF) do not display on the summary row, the calculation cannot be performed.

```
TABLE FILE GGSales
SUM UNITS DOLLARS BUDDOLLARS
AND COMPUTE DIFF/I10 = DOLLARS-BUDDOLLARS;
  BY REGION
  BY CATEGORY
  WHERE CATEGORY EQ 'Food' OR 'Coffee'
  WHERE REGION EQ 'West' OR 'Midwest'
  ON REGION RECOMPUTE MAX. DOLLARS MIN. BUDDOLLARS AVE. DIFF
END
```

The output is:

Region	Category	Unit Sales	Dollar Sales	Budget Dollars	DIFF
-----	-----	-----	-----	-----	---
-					
Midwest	Coffee	332777	4178513	4086032	
92481					
	Food	341414	4338271	4220721	
117550					
*TOTAL Midwest			4338271	4086032	
252239					
West	Coffee	356763	4473517	4523963	-
50446					
	Food	340234	4202337	4183244	
19093					
*TOTAL West			4473517	4183244	
290273					

Using RECOMPUTE at the Sort Break and Grand Total Levels

The following example adds the ON TABLE RECOMPUTE command to the previous request ([Using Prefix Operators With RECOMPUTE](#)) to calculate the average values for each column. Notice that the value of DIFF is calculated as the difference between the values in the Dollar Sales and the Budget Dollars columns on the grand total line:

```
TABLE FILE GGSales
SUM UNITS DOLLARS BUDDOLLARS
AND COMPUTE DIFF/I10 = DOLLARS-BUDDOLLARS;
  BY REGION
  BY CATEGORY
  WHERE CATEGORY EQ 'Food' OR 'Coffee'
  WHERE REGION EQ 'West' OR 'Midwest'
  ON REGION RECOMPUTE MAX. DOLLARS MIN. BUDDOLLARS DIFF
ON TABLE RECOMPUTE AVE.
END
```

The output is:

Region	Category	Unit Sales	Dollar Sales	Budget Dollars	DIFF
Midwest	Coffee	332777	4178513	4086032	
92481	Food	341414	4338271	4220721	
117550					
*TOTAL Midwest			4338271	4086032	252239
West	Coffee	356763	4473527	4523963	-
50436	Food	340234	4202338	4183244	
19094					
*TOTAL West			4473527	4183244	290283

TOTAL	342797	4298162	4253490
44672			

Using Multiple SUB-TOTAL or SUMMARIZE Commands With Prefix Operators

SUB-TOTAL and SUMMARIZE propagate their operations to all higher-level sort fields. If a request uses SUB-TOTAL or SUMMARIZE at multiple sort levels, more than one prefix operator may apply to the same field.

When a SUB-TOTAL or SUMMARIZE command on a lower-level sort field propagates up to the higher levels, it applies its prefix operators only to those fields that did not already have different prefix operators specified at the higher level. For any field that had a prefix operator specified at a higher level, the original prefix operator is applied at the level at which it was first specified and to the grand total line, unless a different operator is specified for the grand total line.

Using Multiple SUB-TOTAL Commands With Prefix Operators

The following illustrates prefix operators work in a request that has multiple SUB-TOTAL commands, each with a different prefix operator.

```

DEFINE FILE GGSales
YEAR/YY = DATE;
END

TABLE FILE GGSales
SUM  UNITS DOLLARS/D10.2 BUDDOLLARS
  BY YEAR
  BY ST
  BY REGION
  BY CATEGORY
WHERE REGION EQ 'West' OR 'Midwest'
WHERE ST     EQ 'CA' OR 'IL'

```

```
WHERE YEAR EQ '1996' OR '1997'  
  ON YEAR SUB-TOTAL CNT. UNITS AS '*CNT. UNITS:'  
  ON ST SUB-TOTAL AVE. DOLLARS AS '*AVE. $:'  
  ON REGION SUB-TOTAL MIN. AS '*MIN.:'  
END
```

In the following report output, some of the values have been manually italicized or bolded for clarity:

- Outlined rows are the rows generated by the SUB-TOTAL commands.
- Subtotal values in the normal typeface are the count of unit sales generated by the command ON YEAR SUB-TOTAL CNT. UNITS. This is the topmost summary command, and therefore does not propagate to any other summary lines.
- Subtotal values in italic are average dollar sales generated by the command ON ST SUB-TOTAL AVE. DOLLARS. This is the second summary command, and therefore propagates to the DOLLARS column of summary lines for the YEAR sort field.
- Subtotal values in boldface are minimums within their sort groups generated by the command ON REGION SUB-TOTAL MIN. This is the last summary command, and therefore propagates to all other summary lines, but only calculates minimum values for those columns not already populated with a count or an average.

<u>YEAR</u>	<u>State</u>	<u>Region</u>	<u>Category</u>	<u>Unit Sales</u>	<u>Dollar Sales</u>	<u>Budget</u>	<u>Dollars</u>
1996	CA	West	Coffee	117539	1,484,873.00		1453548
			Food	116389	1,443,083.00		1414902
			Gifts	74948	947,783.00		946382
			*MIN.: West	74948	947,783.00		946382
			*AVE. \$: CA	74948	1,291,913.00		946382
	IL	Midwest	Coffee	52348	683,559.00		628333
			Food	58777	768,715.00		742943
			Gifts	38405	481,515.00		487090
			*MIN.: Midwest	38405	481,515.00		487090
			*AVE. \$: IL	38405	644,596.33		487090
			*CNT. UNITS: 1996	6	968,254.67		487090
1997	CA	West	Coffee	118044	1,453,013.00		1507092
			Food	106322	1,325,429.00		1302582
			Gifts	77328	988,080.00		961841
			*MIN.: West	77328	988,080.00		961841
			*AVE. \$: CA	77328	1,255,507.33		961841
	IL	Midwest	Coffee	57233	715,220.00		737931
			Food	59293	754,132.00		737912
			Gifts	41527	521,260.00		532647
			*MIN.: Midwest	41527	521,260.00		532647
			*AVE. \$: IL	41527	663,537.33		532647
			*CNT. UNITS: 1997	6	959,522.33		532647
TOTAL				12	963,888.50		487090

Combinations of Summary Commands

You can specify a different summary operation for each sort break (BY or ACROSS field).

If you have multiple summary commands for the same sort field, the following message displays and the last summary command specified in the request is used:

```
(FOC36359) MORE THAN 1 SUBTOTAL/SUB-TOTAL/RECOMPUTE/SUMMARIZE
```

There is more than one SUBTOTAL/SUB-TOTAL/RECOMPUTE/SUMMARIZE on the same key field which is not allowed. The last one specified will override the rest.

SUMMARIZE and SUB-TOTAL, which propagate their summary operations to higher-level sort breaks, skip those fields at higher-level sort breaks that have their own summary commands. The propagation of summary operations depends on whether prefix operator processing is used for summary lines. If the prefix operators are:

- Not used on summary lines, if any summary command specifies a field list, only the fields specified on the summary line field lists are populated on the report.
- Used on summary lines, SUB-TOTAL and SUMMARIZE propagate to:
 - All fields at higher-level sort breaks that do not have their own summary command.
 - Fields not specified in the field list at higher-level sort breaks that do have their own summary commands (columns that would have been empty). Note that this is the only technique that allows different fields at the same sort break to have different summary options.

Prefix operators on summary lines result in the same values whether the command is RECOMPUTE/SUMMARIZE or SUBTOTAL/SUB-TOTAL. For a computed field, the prefix operator is not applied, and the value is recalculated using the expression in the COMPUTE command and the values from the summary line.

When you use different summary commands for different sort fields, the default grand total row inherits the summary command associated with the first sort field in the request. You can change the operation performed at the grand total level by using the ON TABLE phrase to specify a specific summary command.

i Note: The grand total is considered the highest sort level. Therefore, although you can use the SUMMARIZE or SUB-TOTAL command at the grand total level, these commands apply only to the grand total and are not propagated to any other line on the report. On the grand total level SUMMARIZE operates as a RECOMPUTE command, and SUB-TOTAL operates as a SUBTOTAL command.

Using SUBTOTAL and RECOMPUTE in a Request

In the following request, the first sort field specified is COPIES, which is associated with the RECOMPUTE command. Therefore, on the grand total line, the value of RATIO is correctly recomputed and the values of LISTPR and WHOLESALPR are summed (because this is the default operation when the field is not calculated by a COMPUTE command).

```
TABLE FILE MOVIES
PRINT DIRECTOR LISTPR WHOLESALPR
COMPUTE RATIO = LISTPR/WHOLESALPR;
BY COPIES
```

```

BY RATING
WHERE COPIES LT 3
WHERE DIRECTOR EQ 'DISNEY W.' OR 'HITCHCOCK A.'
ON COPIES RECOMPUTE AS '*REC: '
ON RATING SUBTOTAL AS '*SUB: '
END

```

The output is:

COPIES	RATING	DIRECTOR	LISTPR	WHOLESALEPR	RATIO
1	NR	DISNEY W.	29.95	15.99	1.87
*SUB:	NR		29.95	15.99	1.87
*REC:	1		29.95	15.99	1.87
2	NR	HITCHCOCK A.	19.98	9.00	2.22
*SUB:	NR		19.98	9.00	2.22
	PG	HITCHCOCK A.	19.98	9.00	2.22
		HITCHCOCK A.	19.98	9.00	2.22
*SUB:	PG		39.96	18.00	4.44
2	PG13	HITCHCOCK A.	19.98	9.00	2.22
*SUB:	PG13		19.98	9.00	2.22
	R	HITCHCOCK A.	19.98	9.00	2.22
*SUB:	R		19.98	9.00	2.22
*REC:	2		99.90	45.00	2.22
TOTAL			129.85	60.99	2.13

If you reverse the BY fields, the grand total line sums the RATIO values as well as the LISTPR and WHOLESALEPR values because the SUBTOTAL command controls the grand total line:

TOTAL	129.85	60.99	12.97
-------	--------	-------	-------

You can change the operation performed at the grand total level by adding the following command to the request:

```
ON TABLE RECOMPUTE
```

The grand total line then displays the recomputed values:

TOTAL	129.85	60.99	2.13
-------	--------	-------	------

Using SUB-TOTAL With Multiple Summary Commands

In the following request, the SUB-TOTAL command propagates its operation to the DIRECTOR sort field (see the total line for HITCHCOCK, on which the RATIO values are subtotaled, not recomputed).

SUB-TOTAL is not propagated to the RATING sort field which has its own RECOMPUTE command, and for this sort field the RATIO value is recomputed. The grand total line is recomputed because RECOMPUTE is performed on a higher level sort field than SUB-TOTAL.

```
TABLE FILE MOVIES
PRINT LISTPR WHOLESALEPR
COMPUTE RATIO = LISTPR/WHOLESALEPR;
BY DIRECTOR
BY RATING
BY COPIES
WHERE COPIES LT 3
WHERE DIRECTOR EQ 'HITCHCOCK A.'
ON COPIES SUB-TOTAL AS '*SUB: '
ON RATING RECOMPUTE AS '*REC: '
END
```

The output is:

DIRECTOR	RATING	COPIES	LISTPR	WHOLESALEPR	RATIO
-----	-----	-----	-----	-----	-----
HITCHCOCK A.	NR	2	19.98	9.00	2.22
*SUB: 2			19.98	9.00	2.22
*REC: NR			19.98	9.00	2.22

	PG	2	19.98	9.00	2.22
			19.98	9.00	2.22
*SUB:	2		39.96	18.00	4.44
*REC:	PG		39.96	18.00	2.22
	PG13	2	19.98	9.00	2.22
*SUB:	2		19.98	9.00	2.2
*REC:	PG13		19.98	9.00	2.2
HITCHCOCK A.	R	2	19.98	9.00	2.2
*SUB:	2		19.98	9.00	2.2
*REC:	R		19.98	9.00	2.2
*TOTAL	DIRECTOR HITCHCOCK A.		99.90	45.00	11.1
TOTAL			99.90	45.00	2.2

Using Multiple Summary Commands With Prefix Operators

The following request prints the average value of LISTPR and the recomputed value of RATIO on the lines associated with sort field RATING. The SUB-TOTAL command associated with sort field COPIES is propagated to all fields on the DIRECTOR sort field lines and to the WHOLESALEPR and RATIO1 columns associated with the RATING sort field. The grand total line is suppressed for this request.

```
TABLE FILE MOVIES
PRINT LISTPR WHOLESALEPR
COMPUTE RATIO/D6.2 = LISTPR/WHOLESALEPR;
COMPUTE RATIO1/D6.2 = LISTPR/WHOLESALEPR;
BY DIRECTOR
BY RATING
BY COPIES
WHERE COPIES LT 3
  WHERE DIRECTOR EQ 'KAZAN E.'
  ON RATING RECOMPUTE AVE. LISTPR RATIO AS '*REC: '
  ON COPIES SUB-TOTAL AS '*SUB: '
  ON TABLE NOTOTAL
END
```

On the output:

- The values of WHOLESALEPR and RATIO1 on the row labeled *REC are subtotals because of propagation of the SUB-TOTAL command to the fields not specified in the RECOMPUTE command.
- The LISTPR value is an average and the value of RATIO (which has the same definition as RATIO1) is recomputed because these two fields are specified in the RECOMPUTE command.
- The SUB-TOTAL command is propagated to the DIRECTOR row.

The output is:

DIRECTOR	RATING	COPIES	LISTPR	WHOLESALEPR	RATIO	RATIO1
-----	-----	-----	-----	-----	-----	-----
KAZAN E.	NR	1	24.98	14.99	1.67	1.67
*SUB: 1			24.98	14.99	1.67	1.67
		2	19.95	9.99	2.00	2.00
*SUB: 2			19.95	9.99	2.00	2.00
*REC: NR			22.46	24.98	.90	3.66
*TOTAL DIRECTOR KAZAN E.			44.93	24.98	3.66	3.66

Propagation of Summary Commands With Field Lists

In the following request, the RECOMPUTE command has a field list.

```
TABLE FILE MOVIES
PRINT LISTPR WHOLESALEPR
COMPUTE RATIO/D6.2 = LISTPR/WHOLESALEPR;
COMPUTE RATIO1/D6.2 = LISTPR/WHOLESALEPR;
BY DIRECTOR
BY RATING
BY COPIES
WHERE COPIES LT 3
  WHERE DIRECTOR EQ 'KAZAN E.'
  ON RATING RECOMPUTE LISTPR RATIO AS '*REC: '
```

```
ON COPIES SUB-TOTAL AS '*SUB: '
END
```

SUB-TOTAL propagates to all of the columns that would otherwise be unpopulated. The grand total line inherits the RECOMPUTE command for the fields listed in its field list, and the SUB-TOTAL command propagates to the other columns:

DIRECTOR	RATING	COPIES	LISTPR	WHOLESALEPR	RATIO	RATIO1
-----	-----	-----	-----	-----	-----	-----
KAZAN E.	NR	1	24.98	14.99	1.67	1.67
*SUB: 1			24.98	14.99	1.67	1.67
		2	19.95	9.99	2.00	2.00
*SUB: 2			19.95	9.99	2.00	2.00
*REC: NR			44.93	24.98	1.80	3.66
*TOTAL DIRECTOR KAZAN E.			44.93	24.98	3.66	3.66
TOTAL			44.93	24.98	1.80	3.66

Usage Notes for Combinations of Summary Commands

- SET SUMMARYLINES=EXPLICIT affects propagation of summary commands to the grand total line by making it consistent with the behavior for any sort break. Therefore, with this setting in effect, SUB-TOTAL and SUMMARIZE propagate to the grand total line but SUBTOTAL and RECOMPUTE do not.

Producing Summary Columns for Horizontal Sort Fields

The summary commands SUBTOTAL, SUB-TOTAL, SUMMARIZE, and RECOMPUTE can be used with horizontal sort breaks.

When a request has multiple display fields and an ACROSS sort field, the report output has multiple columns under each ACROSS value. If you want to apply a summary field to some of the columns for each ACROSS value, but not others, you can specify the field names you want summarized. This technique is most useful for report requests that use the OVER phrase to place the fields on separate rows

Produce a Summary Operation on a Horizontal Sort Field

```
{ACROSS|ON} acrossfield [AS 'text1'] sumoption [AS 'text2']
      [COLUMNS c1 [AND c2 ...]]
```

or

```
ACROSS acrossfieldsumoption [field1field2 ... fieldn]
```

or

```
ACROSS acrossfield
```

```
ON acrossfieldsumoption [field1field2 ... fieldn]
```

where:

acrossfield

Is the ACROSS field whose for which you want to generate the summary option. The end of the values for the ACROSS field triggers the summary operation.

sumoption

Can be one of the following: SUBTOTAL, SUB-TOTAL, RECOMPUTE, or SUMMARIZE.

'text1'

Is the column heading to use for the break field on the report output.

'text2'

Is the text that prints on the top of the summary column.

COLUMNSc1, c2 ...

Lists the specific ACROSS values that you want to display on the report output in the order in which you want them. This list of values cannot be specified in an ON phrase. If it is specified in an ACROSS phrase, it must be the last option specified in the ACROSS phrase.

field1field2 ... fieldn

Are the fields that will have the summary command applied. If no fields are listed, all fields will be summarized.

Usage Notes for Summaries on ACROSS Fields

- SUMMARIZE and SUB-TOTAL operate on the ACROSS field for which they are specified and for all higher level ACROSS fields. They do not operate on BY fields. SUBTOTAL and RECOMPUTE operate only on the ACROSS field for which they are specified. However, the summary is not produced until the higher level ACROSS field changes value.
- SUMMARIZE and SUB-TOTAL commands specified for a BY field operate on that BY and all higher level BY fields. They do not operate on ACROSS fields.
- ROW-TOTAL, ACROSS-TOTAL, SUBTOTAL, and SUB-TOTAL sum the values in the columns. Unlike SUMMARIZE and RECOMPUTE, they do not reapply calculations other than sums.
- Summary commands specified in an ON TABLE phrase operate on columns, not rows.
- With ACROSS, summary columns only display at the end of the ACROSS group (when the higher-level ACROSS field changes value).
- Different operations from two ON phrases for the same sort break display in the same summary column, and allow a mixture of operations on summary columns.
- If the same field is referenced in more than one ON phrase for the same sort break, the last summary command specified is applied.
- You can specify a different summary operation for each sort break.

- The SUMMARYLINES parameter does not affect processing for ACROSS fields.
- When used with OVERs, the rows containing fields not to be summarized will be blank.
- Prefix operators are supported on summary lines:
 - The following prefix operators are supported for numeric fields: ASQ., AVE., CNT., FST., LST., MAX., MIN., SUM.
 - Prefix operators PCT., RPCT., AND TOT. are not supported.
 - Double prefix operators (such as PCT.CNT.) are not supported.
 - The SUM. prefix operator produces the same summary values as a summary phrase with no prefix operator.
 - SUMMARIZE and RECOMPUTE apply the calculations defined in the associated COMPUTE command to the summary values. Therefore, in order to perform the necessary calculations, the SUMMARIZE or RECOMPUTE command must specify all of the fields referenced in the COMPUTE command.
 - If the same field has summary operations with different prefix operators at each level, the appropriate calculation is done at each level for the prefix operator specified.
 - SUB-TOTAL and SUMMARIZE propagate their operations to all higher-level sort fields. If a request uses SUB-TOTAL or SUMMARIZE at multiple sort levels, more than one prefix operator may apply to the same field. When a SUB-TOTAL or SUMMARIZE command on a lower-level sort field propagates up to the higher levels, it applies its prefix operators only to those fields that did not already have a prefix operator specified at the higher level. For any field that had a prefix operator specified at a higher level, the original prefix operator is applied at the level at which it was first specified.
 - Prefix operators on summary lines result in the same values whether the command is RECOMPUTE/SUMMARIZE or SUBTOTAL/SUB-TOTAL. For a computed field, the prefix operator is not applied, and the value is recalculated using the expression in the COMPUTE command and the values from the summary line.
 - If an ACROSS field has an ACROSS-TOTAL phrase and a summary command with a prefix operator, the prefix operator is applied, not the ACROSS-TOTAL.

Using Summary Commands With ACROSS

The following request sums units and dollars and calculates the unit cost by product and across region and month. The ACROSS MNTH RECOMPUTE command creates totals of units and dollars, and recomputes the calculated value for the selected months within regions. The ACROSS REGION RECOMPUTE command does the same for the selected regions. The ON TABLE SUMMARIZE command creates summary rows. It has no effect on columns:

```
DEFINE FILE GGSALES
Mnth/MTr = DATE;
END
TABLE FILE GGSALES
SUM
  UNITS/I5 AS 'UNITS'                OVER
  DOLLARS/I6 AS 'DOLLARS'            OVER
  COMPUTE DOLLPER/I6 = DOLLARS/UNITS; AS 'UNIT COST'
BY PRODUCT
ACROSS REGION RECOMPUTE AS 'Region Sum' COLUMNS 'Northeast' AND 'West'
ACROSS MNTH RECOMPUTE AS 'Month Sum' COLUMNS 'November' AND 'December'
WHERE DATE FROM '19971101' TO '19971231';
WHERE PRODUCT EQ 'Capuccino' OR 'Espresso';
ON TABLE SUMMARIZE AS 'Grand Total'
ON TABLE HOLD FORMAT HTML
END
```

The output is:

PAGE 1								
		Region						
		Northeast				West		Region Sum
		Mnth						
		NOVEMBER	DECEMBER	Month Sum	NOVEMBER	DECEMBER	Month Sum	
Product								
Capuccino	UNITS	2282	1188	3470	2535	4051	6586	10056
	DOLLARS	25994	13668	39662	31153	57421	88574	128236
	UNIT COST	11	11	11	12	14	13	12
Espresso	UNITS	1947	2403	4350	3088	3732	6820	11170
	DOLLARS	23629	30605	54234	36123	51400	87523	141757
	UNIT COST	12	12	12	11	13	12	12
Grand Total	UNITS	4229	3591	7820	5623	7783	13406	21226
	DOLLARS	49623	44273	93896	67276	108821	176097	269993
	UNIT COST	11	12	12	11	13	13	12

Subtotaling One Field Within an ACROSS Group

The following request from the GGSales data source sums the DOLLARS and UNITS fields by CATEGORY and across REGION, but subtotals only the UNITS field.

```
TABLE FILE GGSales
SUM DOLLARS AS 'Dollars' OVER
UNITS AS 'Units'
  BY CATEGORY
  ACROSS REGION SUBTOTAL UNITS
WHERE REGION EQ 'Midwest' OR 'West'
ON TABLE SET PAGE NOPAGE
END
```

The output shows that only the rows with the UNITS values are subtotaled.

		Region		
		Midwest	West	TOTAL
Category		-----		
Coffee	Dollars	4178513	4473517	
	Units	332777	356763	689540
Food	Dollars	4338271	4202337	
	Units	341414	340234	681648

Gifts	Dollars	2883881	2977092	
	Units	230854	235042	465896

Summarizing a Calculated Value in an ACROSS Group

The following request against the GGSales data source sums the DOLLARS and UNITS fields and calculates DOLLARS PER UNIT across REGION. The request also has a higher-level ACROSS field, CATEGORY, so the SUMMARIZE command propagates to both ACROSS fields.

```
SET BYPANEL = ON
TABLE FILE GGSales
SUM DOLLARS AS 'Dollars' OVER
UNITS AS 'Units'          OVER
AND COMPUTE DPERU/D9.2 = DOLLARS/UNITS;
  ACROSS CATEGORY
  ACROSS REGION
  ON REGION SUMMARIZE DPERU
  WHERE REGION EQ 'Midwest' OR 'West'
  WHERE CATEGORY EQ 'Food' OR 'Gifts'
  ON TABLE HOLD FORMAT PDF
END
```

The first panel of output shows:

- The values of DOLLARS, UNITS, and DPERU for the Midwest and West regions under the Food category.
- The summary column, which has a value just for the DPERU row. Note that for ACROSS, the summary column for REGION appears only after the higher-level ACROSS field, CATEGORY, changes value.
- The values of DOLLARS, UNITS, and DPERU for the Midwest and West regions under the Gifts category.

PAGE 1.1

Category
Food

Gifts

	Region Midwest	West	TOTAL	Midwest	West
-					
Dollars	4338271	4202337		2883881	2977092
Units	341414	340234		230854	235042
DPERU	12.71	12.35	12.53	12.49	12.67

The second panel has the total column for the Gifts category and the grand total column. Each of those only has a value in the DPERU row.

PAGE		1.2	
Category		TOTAL	
Region	TOTAL		
Dollars			
Units			
DPERU	12.58	12.55	

Using Prefix Operators in a Summary Command With ACROSS

The following request against the GGSales data source sums the DOLLARS and UNITS fields ACROSS CATEGORY and ACROSS REGION, with a SUMMARIZE command on the REGION field. The request also has a higher-level ACROSS field, CATEGORY, so the SUMMARIZE command propagates to both ACROSS fields. The SUMMARIZE command specifies the AVE. prefix operator for the DOLLARS field.

```
SET BYPANEL = ON
TABLE FILE GGSales
SUM DOLLARS AS 'Dollars' OVER
UNITS AS 'Units'
  ACROSS CATEGORY
  ACROSS REGION
  ON REGION SUMMARIZE AVE. DOLLARS
WHERE REGION EQ 'Midwest' OR 'West'
```

```

WHERE CATEGORY EQ 'Food' OR 'Gifts'
ON TABLE HOLD FORMAT PDF
END

```

The first panel of output shows:

- The values of DOLLARS and UNITS for the Midwest and West regions under the Food category.
- The summary column, which has a value just for the DOLLARS row. Note that for ACROSS, the summary column for REGION appears only after the higher-level ACROSS field, CATEGORY, changes value.
- The values of DOLLARS and UNITS for the Midwest and West regions under the Gifts category.

PAGE 1.1

	Category Food			Gifts	
	Region Midwest	West	TOTAL	Midwest	West
-					
Dollars	4338271	4202337	4270304	2883881	2977092
Units	341414	340234		230854	235042

The second panel has the total column for the Gifts category and the grand total column. Each of those only has a value in the DOLLARS row.

PAGE 1.2

	Category Region TOTAL	TOTAL
Dollars	2930486	3600395
Units		

Using Combinations of ACROSS Summary Commands

The following request against the GGSales data source sums the DOLLARS and UNITS fields ACROSS CATEGORY and ACROSS REGION, with a SUMMARIZE command on the REGION field and a SUBTOTAL command on the CATEGORY field. The SUMMARIZE command specifies average DOLLARS and minimum UNITS. The SUBTOTAL command specifies minimum DOLLARS.

```
SET BYPANEL = ON
TABLE FILE GGSales
SUM DOLLARS AS 'Dollars' OVER
UNITS AS 'Units'
  ACROSS CATEGORY
  ACROSS REGION
    ON CATEGORY SUBTOTAL MIN. DOLLARS
    ON REGION SUMMARIZE AVE. DOLLARS MIN. UNITS
  WHERE REGION EQ 'Midwest' OR 'West'
  WHERE CATEGORY EQ 'Food' OR 'Gifts'

END
```

On the output, all of the TOTAL columns have the minimum UNITS. The TOTAL columns associated with the REGION sort field have the average DOLLARS, but the TOTAL column associated with the CATEGORY sort field has the minimum DOLLARS because SUMMARIZE does not change the prefix operator associated with a higher-level sort field.

PAGE 1.1

	Category			Gifts	
	Food			Midwest	West
	Region				
	Midwest	West	TOTAL	Midwest	West
-					
Dollars	4338271	4202337	4270304	2883881	2977092
Units	341414	340234	340234	230854	235042

PAGE 1.2

	Category	TOTAL
	Region	
	TOTAL	
Dollars	2930486	2883881
Units	230854	230854

Performing Calculations at Sort Field Breaks

You can use the RECAP and COMPUTE commands to create subtotal values in a calculation. The subtotal values are not displayed. Only the result of the calculation is shown on the report.

Use Subtotals in Calculations

Both the RECAP and COMPUTE commands have similar syntax to other total and subtotal commands.

```
{BY|ON} fieldname1 {RECAP|COMPUTE} fieldname2[/format] = expression;
                               [WHEN expression;]
```

where:

fieldname1

Is the field in the BY phrase. Each time the BY field changes value, a new recap value is calculated.

fieldname2

Is the field name that contains the result of the expression.

/format

Can be any valid format. The default is D12.2.

expression

Can be any valid expression, as described in [Using Expressions](#). You must end the expression with a semicolon.

WHEN expression

Is for use with RECAP only. It specifies the conditional display of RECAP lines as determined by a Boolean expression (see [Conditionally Displaying Summary Lines and Text](#)). You must end the expression with a semicolon.

Usage Notes for RECAP and COMPUTE

- RECAP uses the current value of the named sort field, the current subtotal values of any computational fields that appear as display fields, or the last value for alphanumeric fields.
- RECAP reserves space at the bottom of the page to ensure that a RECAP will not be alone at the top of the next page while the data it is recapping is on the previous page. The same technique is used for subtotals and grand totals, but not for subfootings or COMPUTEs.
- The field names in the expression must be fields that appear on the report. That is, they must be display fields or sort control fields.
- Each RECAP value displays on a separate line. However, if the request contains a RECAP command and SUBFOOT text, the RECAP value displays only in the SUBFOOT text and must be specified in the text using a spot marker.
- The calculations in a RECAP or COMPUTE can appear anywhere under the control break, along with any text.
- In an ON phrase, a COMPUTE command is the same as a RECAP command.
- The limit for ON *sortfield* RECAP phrases is 64 for each sort field.
- You can specify multiple recap calculations in one RECAP phrase. Use the following syntax:

```
ON sortfield RECAP field1/format= ... ;field2/format= ... ;  
.  
.
```

Using RECAP

The following request illustrates the use of RECAP (DEPT_NET) to determine net earnings for each department:

```
TABLE FILE EMPLOYEE
SUM DED_AMT AND GROSS
BY DEPARTMENT BY PAY_DATE
ON DEPARTMENT RECAP DEPT_NET/D8.2M = GROSS-DED_AMT;
WHEN PAY_DATE GT 820101
END
```

The output is:

DEPARTMENT	PAY_DATE	DED_AMT	GROSS
-----	-----	-----	-----
MIS	81/11/30	\$1,406.79	\$2,147.75
	81/12/31	\$1,406.79	\$2,147.75
	82/01/29	\$1,740.89	\$3,247.75
	82/02/26	\$1,740.89	\$3,247.75
	82/03/31	\$1,740.89	\$3,247.75
	82/04/30	\$3,386.73	\$5,890.84
	82/05/28	\$3,954.35	\$6,649.50
	82/06/30	\$4,117.03	\$7,460.00
	82/07/30	\$4,117.03	\$7,460.00
	82/08/31	\$4,575.72	\$9,000.00
** DEPT_NET		\$22,311.98	
PRODUCTION	81/11/30	\$141.66	\$833.33
	81/12/31	\$141.66	\$833.33
	82/01/29	\$1,560.09	\$3,705.84
	82/02/26	\$2,061.69	\$4,959.84
	82/03/31	\$2,061.69	\$4,959.84
	82/04/30	\$2,061.69	\$4,959.84
	82/05/28	\$3,483.88	\$7,048.84
	82/06/30	\$3,483.88	\$7,048.84
	82/07/30	\$3,483.88	\$7,048.84
	82/08/31	\$4,911.12	\$9,523.84

```
** DEPT_NET          $27,531.14
```

Using Multiple RECAP Commands

You can include multiple RECAP or COMPUTE commands in a request. This option enables you to perform different calculations at different control breaks.

The following request illustrates the use of multiple RECAP commands.

```
TABLE FILE SALES
SUM UNIT_SOLD AND RETURNS
WHERE AREA EQ 'U'
BY DATE BY AREA BY PROD_CODE
ON DATE RECAP
DATE_RATIO=RETURNS/UNIT_SOLD;
ON AREA UNDER-LINE RECAP
AREA_RATIO=RETURNS/UNIT_SOLD;
END
```

The output is:

DATE	AREA	PROD_CODE	UNIT_SOLD	RETURNS
10/17	U	B10	30	2
		B17	20	2
		B20	15	0
		C17	12	0
		D12	20	3
		E1	30	4
		E3	35	4
** AREA_RATIO				.09
** DATE_RATIO				.09

10/18	U	B10	13	1
** AREA_RATIO				.08
** DATE_RATIO				.08

```

-----
10/19  U      B12                29          1
** AREA_RATIO                .03
** DATE_RATIO                .03
-----

```

Suppressing Grand Totals

You can use the NOTOTAL command to suppress grand totals in a report.

Suppressing the grand total is useful when there is only one value at a sort break, since the grand total value is equal to that one value. Using the NOTOTAL command prevents the report from displaying a grand total line for every sort break that has only one detail line. You can also suppress subtotals using the MULTILINES command. For details, see [Create Subtotals](#).

Suppress Grand Totals

To suppress grand totals, add the following syntax to your request:

```
ON TABLE NOTOTAL
```

Suppressing Grand Totals

The following request includes the NOTOTAL phrase to suppress grand totals for CURR_SAL, GROSS, and DED_AMT.

```

TABLE FILE EMPLOYEE
SUM CURR_SAL AND GROSS AND DED_AMT
BY EMP_ID
BY BANK_ACCT

```

```

WHERE BANK_ACCT NE 0
ON BANK_ACCT SUB-TOTAL
ON TABLE NOTOTAL
END

```

The output is:

EMP_ID	BANK_ACCT	CURR_SAL	GROSS	DED_AMT
-----	-----	-----	-----	-----
117593129	40950036	\$18,480.00	\$6,099.50	\$2,866.18
*TOTAL	40950036	\$18,480.00	\$6,099.50	\$2,866.18
*TOTAL	117593129	\$18,480.00	\$6,099.50	\$2,866.18
119329144	160633	\$29,700.00	\$2,475.00	\$1,427.24
*TOTAL	160633	\$29,700.00	\$2,475.00	\$1,427.24
*TOTAL	119329144	\$29,700.00	\$2,475.00	\$1,427.24
123764317	819000702	\$26,862.00	\$17,094.00	\$11,949.44
*TOTAL	819000702	\$26,862.00	\$17,094.00	\$11,949.44
*TOTAL	123764317	\$26,862.00	\$17,094.00	\$11,949.44
326179357	122850108	\$21,780.00	\$9,075.00	\$6,307.00
*TOTAL	122850108	\$21,780.00	\$9,075.00	\$6,307.00
*TOTAL	326179357	\$21,780.00	\$9,075.00	\$6,307.00
451123478	136500120	\$16,100.00	\$9,130.00	\$3,593.92
*TOTAL	136500120	\$16,100.00	\$9,130.00	\$3,593.92
*TOTAL	451123478	\$16,100.00	\$9,130.00	\$3,593.92
818692173	163800144	\$27,062.00	\$22,013.75	\$15,377.40
*TOTAL	163800144	\$27,062.00	\$22,013.75	\$15,377.40
*TOTAL	818692173	\$27,062.00	\$22,013.75	\$15,377.40

<u>EMP ID</u>	<u>BANK ACCT</u>	<u>CURR SAL</u>	<u>GROSS</u>	<u>DED AMT</u>
117593129	40950036	\$18,480.00	\$6,099.50	\$2,866.18
*TOTAL 40950036		\$18,480.00	\$6,099.50	\$2,866.18
*TOTAL 117593129		\$18,480.00	\$6,099.50	\$2,866.18
119329144	160633	\$29,700.00	\$2,475.00	\$1,427.24
*TOTAL 160633		\$29,700.00	\$2,475.00	\$1,427.24
*TOTAL 119329144		\$29,700.00	\$2,475.00	\$1,427.24
123764317	819000702	\$26,862.00	\$17,094.00	\$11,949.44
*TOTAL 819000702		\$26,862.00	\$17,094.00	\$11,949.44
*TOTAL 123764317		\$26,862.00	\$17,094.00	\$11,949.44
326179357	122850108	\$21,780.00	\$9,075.00	\$6,307.00
*TOTAL 122850108		\$21,780.00	\$9,075.00	\$6,307.00
*TOTAL 326179357		\$21,780.00	\$9,075.00	\$6,307.00
451123478	136500120	\$16,100.00	\$9,130.00	\$3,593.92
*TOTAL 136500120		\$16,100.00	\$9,130.00	\$3,593.92
*TOTAL 451123478		\$16,100.00	\$9,130.00	\$3,593.92
818692173	163800144	\$27,062.00	\$22,013.75	\$15,377.40
*TOTAL 163800144		\$27,062.00	\$22,013.75	\$15,377.40
*TOTAL 818692173		\$27,062.00	\$22,013.75	\$15,377.40

Conditionally Displaying Summary Lines and Text

In addition to using summary lines to control the look and content of your report, you can specify WHEN criteria to control the conditions under which summary lines appear for each vertical (BY) sort field value. WHEN is supported with SUBFOOT, SUBHEAD, SUBTOTAL, SUB-TOTAL, SUMMARIZE, RECOMPUTE, and RECAP.

Conditionally Displaying Summary Lines and Text

In a sales report that covers four regions (Midwest, Northeast, Southeast, and West), you may only want to display a subtotal when total dollar sales are greater than \$11,500,000. The following request accomplishes this by including criteria that trigger the display of a subtotal when dollar sales exceed \$11,500,000 and subfooting text when dollar sales are less than \$11,500,000.

```
TABLE FILE GGSales
SUM UNITS DOLLARS
BY REGION
BY CATEGORY
ON REGION SUBTOTAL
WHEN DOLLARS GT 11500000
SUBFOOT
"The total for the <REGION region is less than 11500000."
WHEN DOLLARS LT 11500000
END
```

The output is:

Region	Category	Unit Sales	Dollar Sales
-----	-----	-----	-----
Midwest	Coffee	332777	4178513
	Food	341414	4338271
	Gifts	230854	2883881

The total for the Midwest region is less than 11500000.

Northeast	Coffee	335778	4164017
	Food	353368	4379994
	Gifts	227529	2848289

The total for the Northeast region is less than 11500000.

Southeast	Coffee	350948	4415408
	Food	349829	4308731
	Gifts	234455	2986240

*TOTAL Southeast		935232	11710379
------------------	--	--------	----------

West	Coffee	356763	4473517
	Food	340234	4202337
	Gifts	235042	2977092

*TOTAL West	932039	11652946
TOTAL	3688991	46156290

Using Expressions

An expression combines field names, constants, and operators in a calculation that returns a single value. You can use an expression in a variety of commands to assign a value to a temporary field or Dialogue Manager ampersand variable, or use it in screening. You can combine simpler ones to build increasingly complex expressions.

When you write an expression, you can specify the operation yourself, or you can use one of the many supplied functions that perform specific calculations or data manipulation. These functions operate on one or more arguments, and return a single value as a result. To use a function, you simply call it. For details about functions, see the *ibi™ FOCUS® Describing Data* manual.

IF-THEN-ELSE logic is supported as part of an expression, including arithmetic, character, and logical expressions. It is also supported in WHERE clauses.

Using Expressions in Commands and Phrases

You can use an expression in various commands and phrases. An expression may not exceed 40 lines and must end with a semicolon, except in WHERE and WHEN phrases, in which the semicolon is optional.

The commands that support expressions, and their basic syntax, are summarized here. For complete syntax with an explanation, see the applicable documentation.

You can use an expression when you:

- Create a temporary field, and assign a value to that field. The field can be created in a Master File using the DEFINE attribute, or using a DEFINE or COMPUTE command:
 - DEFINE command preceding a report request:

```
DEFINE FILE filename
  fieldname [/format] = expression;
  .
  .
```

```
END
```

- DEFINE attribute in a Master File:

```
DEFINE fieldname [/format] = expression;$
```

- COMPUTE command in a report request:

```
COMPUTE fieldname [/format] = expression;
```

- Define record selection criteria and criteria that control report formatting.

```
{WHERE|IF} logical_expression[;]
  WHEN logical_expression[;]
```

- Determine branching in Dialogue Manager, or assign a value to a Dialogue Manager amper variable.

```
-IF logical_expression [THEN] GOTO label1 [ELSE GOTO label2];
```

```
-SET &name = expression;
```

- Perform a calculation with the RECAP command in the Financial Modeling Language (FML).

```
RECAP name [(n)] [/format] = expression;
```

Types of Expressions

An expression can be one of the following:

- **Numeric.** Use numeric expressions to perform calculations that use numeric constants (integer or decimal) and fields. For example, you can write an expression to compute the bonus for each employee by multiplying the current salary by the desired percentage as follows:

```
COMPUTE BONUS/D12.2 = CURR_SAL * 0.05 ;
```

A numeric expression returns a numeric value. For details, see [Creating a Numeric Expression](#).

- **Date.** Use date expressions to perform numeric calculations on dates. For example, you can write an expression to determine when a customer can expect to receive an order by adding the number of days in transit to the date on which you shipped the order as follows:

```
COMPUTE DELIVERY/MDY = SHIPDATE + 5 ;
```

There are two types of date expressions:

- Date expressions, which return a date, a component of a date, or an integer that represents the number of days, months, quarters, or years between two dates. For details, see [Creating a Date Expression](#).
 - Date-time expressions, which you can create using a variety of specialized date-time functions, each of which returns a different kind of value. For details on these functions, see the *ibi™ WebFOCUS® Using Functions* manual.
- **Character.** Use character expressions to manipulate alphanumeric constants or fields. For example, you can write an expression to extract the first initial from an alphanumeric field as follows:

```
COMPUTE FIRST_INIT/A1 = EDIT (FIRST_NAME, '9$$$$$$$$$') ;
```

A character expression returns an alphanumeric value. For details, see [Creating a Character Expression](#).

Note: Text fields can be assigned to alphanumeric fields and receive assignment from alphanumeric fields. Text fields can also participate in expressions using the operators CONTAINS and OMITS.

- **Logical.** Use logical expressions to evaluate the relationship between two values. A logical expression returns TRUE or FALSE. For details, see [Creating a Logical Expression](#).
- **Conditional.** Use conditional expressions to assign values based on the result of logical expressions. A conditional expression (IF ... THEN ... ELSE) returns a numeric

or alphanumeric value. For details, see [Creating a Conditional Expression](#).

Expressions and Field Formats

When you use an expression to assign a value to a field, make sure that you give the field a format that is consistent with the value returned by the expression. For example, if you use a character expression to concatenate a first name and last name and assign it to the field FULL_NAME, make sure you define the field as a character.

Assigning a Field Format of Sufficient Length

The following example contains a character expression that concatenates a first name and last name to derive the full name. It assigns the field FULL_NAME an alphanumeric format of sufficient length to accommodate the concatenated name:

```
DEFINE FILE EMPLOYEE  
FULL_NAME/A25 = FIRST_NAME | LAST_NAME;  
END  
TABLE FILE EMPLOYEE  
PRINT FULL_NAME  
WHERE LAST_NAME IS 'BLACKWOOD'  
END
```

The output is:

```
FULL_NAME  
-----  
ROSEMARIE BLACKWOOD
```

Creating a Numeric Expression

A numeric expression performs a calculation that uses numeric constants, fields, operators, and functions to return a numeric value. When you use a numeric expression to assign a value to a field, that field must have a numeric format. The default format is D12.2.

A numeric expression can consist of the following components, shown below in bold:

- A numeric constant. For example:

```
COMPUTE COUNT/I2 = 1 ;
```

- A numeric constant in scientific notation. For example:

```
COMPUTE COST/D12.2 = EXPN(8E+3) ;
```

For syntax usage, see [Express a Number in Scientific Notation](#).

- A numeric field. For example:

```
COMPUTE RECOUNT/I2 = COUNT ;
```

- Two numeric constants or fields joined by an arithmetic operator. For example:

```
COMPUTE BONUS/D12.2 = CURR_SAL * 0.05 ;
```

For a list of arithmetic operators, see [Creating a Numeric Expression](#).

- A numeric function. For example:

```
COMPUTE LONGEST_SIDE/D12.2 = MAX (WIDTH, HEIGHT) ;
```

- Two or more numeric expressions joined by an arithmetic operator. For example:

```
COMPUTE PROFIT/D12.2 = (RETAIL_PRICE - UNIT_COST) * UNIT_SOLD ;
```

Note the use of parentheses to change the order of evaluation of the expression. For information on the order in which numeric operations are performed, see [Order of Evaluation](#).

Before they are used in calculations, numeric values are generally converted to double-precision floating-point format. The result is then converted to the specified field format. In some cases the conversion may result in a difference in rounding.

If a number is too large (greater than 10^{75}) or too small (less than 10^{-75}), you receive an Overflow or Underflow warning, and zeros display for the field value.

i Note: You can change the overflow character by issuing the SET OVERFLOWCHAR command.

For detailed information on rounding behavior for numeric data formats, see the *ibi™ FOCUS® Describing Data* manual.

IF-THEN-ELSE logic is supported in numeric expressions.

Express a Number in Scientific Notation

In an IF clause, use the following:

```
IF fieldopn[.nn]{E|D|e|d}[±|-]p
```

In a WHERE clause, use the following:

```
WHERE fieldop EXPN(n[.nn]{E|D|e|d}[±|-]p);
```

In a COMPUTE command, use the following:

```
COMPUTE field[/format] = EXPN(n[.nn]{E|D|e|d}[±|-]p);
```

In a DEFINE command, use the following:

```
DEFINE FILE filename  
field[/format] = EXPN(n[.nn]{E|D|e|d}[±|-]p);  
END
```

In a DEFINE in the Master File, use the following:

```
DEFINE field[/format] = EXPN(n[.nn]{E|D|e|d}[±|-]p);
```

where:

field

Is a field in a request.

/format

Is the optional format of the field. For information on formats, see the *ibi™ FOCUS® Describing Data* manual.

op

Is a relational operator in a request.

n.nn

Is a numeric constant that consists of a whole number component, followed by a decimal point, followed by a fractional component.

E, D, e, d

Denotes scientific notation. E, e, d, and D are interchangeable.

±, -

Indicates if p is positive or negative. Positive is the default.

p

Is the power of 10 to which to raise the number. The range of values for p is between -78 and +78.



Note: EXPN is useful for calculations on fields with F and D formats. It is generally not useful for calculations on fields with P or I formats.

Evaluating a Number in Scientific Notation

You can use scientific notation in an IF or WHERE clause to express 8000 as 8E+03:

```
IF RCOST LT 8E+03
```

```
WHERE RCOST LT EXPN(8E+03)
```

Arithmetic Operators

The following list shows the arithmetic operators you can use in an expression:

Addition	+
Subtraction	-
Multiplication	*
Division	/
Exponentiation	**

i Note: If you attempt to divide by 0, the value of the expression is 0. Multiplication and exponentiation are not supported for date expressions of any type. To isolate part of a date, use a simple assignment command.

Order of Evaluation

Numeric expressions are evaluated in the following order:

1. Exponentiation.
2. Division and multiplication.
3. Addition and subtraction.

When operators are at the same level, they are evaluated from left to right. Because expressions in parentheses are evaluated before any other expression, you can use parentheses to change this predefined order. For example, the following expressions yield different results because of parentheses:

```
COMPUTE PROFIT/D12.2 = RETAIL_PRICE - UNIT_COST * UNIT_SOLD ;
COMPUTE PROFIT/D12.2 = (RETAIL_PRICE - UNIT_COST) * UNIT_SOLD ;
```

In the first expression, UNIT_SOLD is first multiplied by UNIT_COST, and the result is subtracted from RETAIL_PRICE. In the second expression, UNIT_COST is first subtracted from RETAIL_PRICE, and that result is multiplied by UNIT_SOLD.

i Note: Two operators cannot appear consecutively. The following expression is invalid:

```
a * -1
```

To make it valid, you must add parentheses:

```
a* (-1)
```

Controlling the Order of Evaluation

The order of evaluation can affect the result of an expression. Suppose you want to determine the dollar loss in retail sales attributed to the return of damaged items. You could issue the following request:

```
TABLE FILE SALES
PRINT RETAIL_PRICE RETURNS DAMAGED
COMPUTE RETAIL_LOSS/D12.2 = RETAIL_PRICE * RETURNS + DAMAGED;
BY PROD_CODE
WHERE PROD_CODE IS 'E1';
END
```

The calculation

```
COMPUTE RETAIL_LOSS/D12.2 = RETAIL_PRICE * RETURNS + DAMAGED;
```

gives an incorrect result because RETAIL_PRICE is first multiplied by RETURNS, and then the result is added to DAMAGED. The correct result is achieved by adding RETURNS to DAMAGED, then multiplying the result by RETAIL_PRICE.

You can change the order of evaluation by enclosing expressions in parentheses. An expression in parentheses is evaluated before any other expression. You may also use parentheses to improve readability.

Using parentheses, the correct syntax for the preceding calculation is:

```
COMPUTE RETAIL_LOSS/D12.2 = RETAIL_PRICE * (RETURNS + DAMAGED);
```

The output is:

PROD_CODE	RETAIL_PRICE	RETURNS	DAMAGED	RETAIL_LOSS
E1	\$.89	4	7	9.79

Using IF-THEN-ELSE Logic in an Arithmetic Expression

The following request uses IF-THEN-ELSE logic in an arithmetic expression to determine how much to add to LISTPR to calculate NEWPRICE.

```
TABLE FILE MOVIES
SUM COPIES
LISTPR
COMPUTE
NEWPRICE = LISTPR + (IF COPIES GT 10 THEN 0.00 ELSE 25.00);
BY CATEGORY
ON TABLE SET PAGE NOLEAD
ON TABLE SET STYLE *
GRID=OFF,$
ENDSTYLE
END
```

The output is shown in the following image. Where there are more than 10 copies, the NEWPRICE equals LISTPR, otherwise NEWPRICE is \$25.00 greater than LISTPR.

<u>CATEGORY</u>	<u>COPIES</u>	<u>LISTPR</u>	<u>WHOLESALEPR</u>	<u>NEWPRICE</u>
ACTION	14	94.82	55.46	94.82
CHILDREN	12	201.67	105.87	201.67
CLASSIC	21	404.71	201.79	404.71
COMEDY	19	154.80	90.45	154.80
DRAMA	2	19.98	10.00	44.98
FOREIGN	6	269.76	146.24	294.76
MUSICALS	5	84.89	52.97	109.89
MYSTERY	21	235.81	116.97	235.81
SCI/FI	7	114.84	79.52	139.84
TRAIN/EX	10	119.87	60.98	144.87

Evaluating Numeric Expressions With Native-Mode Arithmetic

When native-mode arithmetic is used, a specific evaluation path is followed for each numeric expression based on the format of the operands and the operators. If the operands all have the same format, most operations are carried out in that format. If the operands have different formats, the operands are converted to a common format in a specific order of format precedence. Regardless of operand formats, some operators require conversion to specific formats so that all operands are in the appropriate format.

Using Identical Operand Formats With Native-Mode Arithmetic

If all operands of a numeric operator are of the same format, you can use the following table to determine whether or not the operations are performed in that native format or if the operands are converted before and after executing the operation. In each case requiring conversion, operands are converted to the operational format and the intermediate result is returned in the operational format. If the format of the result differs from the format of the target variable, the result is converted to the format of the target variable.

Operation		Operational Format
Addition	+	Native
Subtraction	-	Native
Multiplication	*	Native
Full Division	/	Accepts single or double-precision floating point, converts all others to double-precision floating point
Exponentiation	**	Double-precision floating point

Using Identical Operand Formats (Native-mode Arithmetic)

The following variables are defined as integers in Maintain Data:

```
COMPUTE OPERANDONE/I4  ;
      OPERANDTWO/I4  ;
      RESULT/I4  ;
```

The required multiplication is done in native-mode arithmetic (integer arithmetic):

```
COMPUTE RESULT/I4 = OPERANDONE * OPERANDTWO  ;
```

Using Different Operand Formats With Native-Mode Arithmetic

If operands of a numeric operator have different formats, you can use the following table to determine what the common format is after they are converted. The lower operand is converted to the format of the higher operand before performing the operation.

Order	Format
1	16-byte packed decimal
2	Double-precision floating point
3	8-byte packed-decimal
4	Single-precision floating point
5	Integer
6	Character (alphanumeric and text)

For example, if a 16-byte packed-decimal operand is used in an expression, all other operands are converted to 16-byte packed-decimal format for evaluation. On the other

hand, if an expression includes only integer and alphanumeric operands, all alphanumeric operands are converted to integer format.

A character (that is, alphanumeric or text) value can be used in a computation if it is a numeric string. An attempt is made to convert the character operand to the format of the other operand in the expression. If both operands are character, an attempt is made to convert them to double-precision. If the conversion is not possible, an error message is generated.

If you assign a decimal value to an integer, the fractional value is truncated.

Creating a Date Expression

A date expression performs a numeric calculation that involves dates.

A date expression returns a date, a date component, or an integer that represents the number of days, months, quarters, or years between two dates. You can write a date expression directly that consists of:

- A date constant. For example:

```
COMPUTE END_DATE/MDYY = 'FEB 29 2000';
```

This requires single quotation marks around the date constant.

- A date field. For example:

```
COMPUTE NEWDATE/YMD = START_DATE;
```

- An alphanumeric, integer, or packed decimal format field, with date edit options. For example, in the second COMPUTE command, OLDDATE is a date expression:

```
COMPUTE OLDDATE/I6YMD = 980307;
COMPUTE NEWDATE/YMD DFC 19 YRT 10 = OLDDATE;
```

- A calculation that uses an arithmetic operator or date function to return a date. Use a numeric operator only with date formats (formerly called Smart dates). The following example first converts the integer date HIRE_DATE (format I6YMD) to the date format CONVERTED_HDT (format YMD). It then adds 30 days to CONVERTED_HDT:

```
COMPUTE CONVERTED_HDT/YMD = HIRE_DATE;
HIRE_DATE_PLUS_THIRTY/YMD = CONVERTED_HDT + 30;
```

- A calculation that uses a numeric operator or date function to return an integer that represents the number of days, months, quarters, or years between two dates. The following example uses the date function YMD to calculate the difference (number of days) between an employee hire date and the date of his first salary increase:

```
COMPUTE DIFF/I4 = YMD (HIRE_DATE, FST.DAT_INC);
```

Formats for Date Values

You can work with dates in one of two ways:

- **In date format.** The value is treated as an integer that represents the number of days between the date value and a base date. There are two base dates for date formats:
 - YMD and YYMD formats have a base date of December 31, 1900.
 - YM and YYM formats have a base date of January, 1901.

When displayed, the integer value is converted to the corresponding date in the format specified for the field. The format can be specified in either the Master File or in the command that uses an expression to assign a value to the field. These were previously referred to as smart date formatted fields.

- **In integer, packed decimal, or alphanumeric format with date edit options.** The value is treated as an integer, a packed decimal, or an alphanumeric string. When displayed, the value is formatted as a date. These were previously referred to as old date formatted fields.

You can convert a date in one format to a date in another format simply by assigning one to the other. For example, the following assignments take a date stored as an alphanumeric field, formatted with date edit options, and convert it to a date stored as a temporary date field:

```
COMPUTE ALPHADATE/A6MDY = '120599' ;
REALDATE/MDY = ALPHADATE;
```

Base Dates for Date Formats

The following table shows the base date for each supported date format:

Format	Base Date
YMD, YYMD, MDYY, DMY, MDY, and DMY	1900/12/31
YM, YYM, MYY, and MY	1901/01 on z/OS 1900/12/31 on Windows and UNIX
YQ, YYQ, QYY, and QY	1901 Q1
JUL and YYJUL	1900/365
D M Y, YY Q W	There is no base date for these formats; these are just numbers, not dates.

Note that the base date used for the functions DA and DT is December 31, 1899. For details on date functions, see the *ibi™ WebFOCUS® Using Functions* manual.

Impact of Date Formats on Storage and Display

The following table illustrates how the field format affects storage and display:

Value	Date Format (For example: MDYY)		Integer, Packed, Decimal, or Alphanumeric Format (For example: A8MDYY)	
	Stored	Displayed	Stored	Displayed
February 28, 1999	35853	02/28/1999	02281999	02/28/1999
March 1, 1999	35854	03/01/1999	03011999	03/01/1999

Performing Calculations on Dates

The format of a field determines how you can use it in a date expression. Calculations on dates in date format can incorporate numeric operators as well as numeric functions. Calculations on dates in integer, packed, decimal, or alphanumeric format require the use of date functions. Numeric operators return an error message or an incorrect result.

A full set of functions is supplied with your software, enabling you to manipulate dates in integer, packed decimal, and alphanumeric format. For details on date functions, see the *ibi™ WebFOCUS® Using Functions* manual.

Calculating Dates

Assume that your company maintains a SHIPPING database. The following example calculates how many days it takes the shipping department to fill an order by subtracting the date on which an item is ordered, the ORDER_DATE, from the date on which it is shipped, the SHIPDATE:

```
COMPUTE TURNAROUND/I4 = SHIP_DATE - ORDER_DATE;
```

An item ordered on February 28, 1999, and shipped on March 1, 1999, results in a difference of one day. However, if the SHIP_DATE and ORDER_DATE fields have an integer format, the result of the calculation (730000) is incorrect, since you cannot use the numeric operator minus (-) with that format.

The following table shows how the field format affects the result:

	Value in Date Format	Value in Integer Format
SHIP_DATE = March 1, 1999	35854	03011999
ORDER_DATE = February 28, 1999	35853	02281999
TURNAROUND	1	730000

To obtain the correct result using fields in integer, packed, decimal, or alphanumeric format, use the date function MDY, which returns the difference between two dates in the form month-day-year. Using the function MDY, you can calculate TURNAROUND as follows:

```
COMPUTE TURNAROUND/I4 = MDY(ORDER_DATE, SHIP_DATE);
```

Cross-Century Dates With DEFINE and COMPUTE

You can use an expression in a DEFINE or COMPUTE command, or in a DEFINE attribute in a Master File, that implements the sliding window technique for cross-century date processing. The parameters DEFCENT and YRTHRESH provide a means of interpreting the century if the first two digits of the year are not provided elsewhere. If the first two digits are provided, they are simply accepted.

Returned Field Format Selection

A date expression always returns a number. That number may represent a date, or the number of days, months, quarters, or years between two dates. When you use a date expression to assign a value to a field, the format selected for the field determines how the result is returned.

Selecting the Format of a Returned Field

Consider the following commands, assuming that SHIP_DATE and ORDER_DATE are date-formatted fields. The first command calculates how many days it takes a shipping department to fill an order by subtracting the date on which an item is ordered, ORDER_DATE, from the date on which it is shipped, SHIP_DATE. The second command calculates a delivery date by adding five days to the date on which the order is shipped.

```
COMPUTE TURNAROUND/I4 = SHIP_DATE - ORDER_DATE;  
COMPUTE DELIVERY/MDY = SHIP_DATE + 5;
```

In the first command, the date expression returns the number of days it takes to fill an order; therefore, the associated field, TURNAROUND, must have an integer format. In the second command, the date expression returns the date on which the item will be delivered; therefore, the associated field, DELIVERY, must have a date format.

Using a Date Constant in an Expression

When you use a date constant in a calculation with a field in date format, you must enclose it in single quotation marks; otherwise, it is interpreted as the number of days between the constant and the base date (December 31, 1900, or January 1, 1901). For example, if 022899 were not enclosed in quotation marks, the value would be interpreted as the 22,899th day after 12/31/1900, rather than as February 28, 1999.

Initializing a Field With a Date Constant

The following command initializes START_DATE with the date constant 02/28/99:

```
COMPUTE START_DATE/MDY = '022899';
```

The following command calculates the number of days elapsed since January 1, 1999:

```
COMPUTE YEAR_TO_DATE/I4 = CURR_DATE - 'JAN 1 1999' ;
```

Extracting a Date Component

Date components include days, months, quarters, or years. You can write an expression that extracts a component from a field in date format. However, you cannot write an expression that extracts days, months, or quarters from a date that does not have these components. For example, you cannot extract a month from a date in YY format, which represents only the number of years.

Extracting the Month Component From a Date

The following example extracts the month component from SHIP_DATE, which has the format MDYY:

```
COMPUTE SHIP_MONTH/M = SHIP_DATE;
```

If SHIP_DATE has the value March 1, 1999, the above expression returns the value 03 for SHIP_MONTH.

A calculation on a date component automatically produces a valid value for the desired component. For example, if the current value of SHIP_MONTH is 03, the following expression correctly returns the value 06:

```
COMPUTE ADD_THREE/M = SHIPMONTH + 3;
```

If the addition of months results in an answer greater than 12, the months are adjusted correctly (for example, 11 + 3 is 2, not 14).

Combining Fields With Different Formats in an Expression

When using fields in date format, you can combine fields with a different order of components within the same expression. In addition, you can assign the result of a date expression to a field with a different order of components from the fields in the expression.

You cannot, however, write an expression that combines dates in date format with dates in integer, packed, decimal or character format.

Combining Fields With Format YYMD and MDY

Consider the two fields DATE_PAID and DUE_DATE. DATE_PAID has the format YYMD, and DUE_DATE has the format MDY. You can combine these two fields in an expression to calculate the number of days that a payment is late:

```
COMPUTE DAYS_LATE/I4 = DATE_PAID - DUE_DATE;
```

Assigning a Different Order of Components to a Returned Field

Consider the field DATE_SOLD. This field contains the date on which an item is sold, in YYMD format. The following expression adds seven days to DATE_SOLD to determine the last date on which the item can be returned. It then assigns the result to a field with DMY format:

```
COMPUTE RETURN_BY/DMY = DATE_SOLD + 7;
```

Creating a Date-Time Expression

A *date-time* expression returns date and time components. You can create these expressions using a variety of supplied date-time functions. For details about date-time functions, see the *ibi™ FOCUS® Describing Data* manual.

Automatic Conversion Between Date and Date-Time Formats

In early releases of date-time fields, you were required to use date-time functions for all conversions between date and date-time formats. While these functions are still supported for conversions, the requirement to use them has been eliminated in certain operations.

The following automatic direct operations are supported between date and date-time formats:

- **Assignment.**

Assignment of a date field or a date constant to a date-time field. The time component is set to zero (midnight). The date can be a full component date such as YYMD or a partial component date such as YYM. It cannot be a single component date such as Q, as this type of date, although displayed as a date in reports, is stored as an integer value and is used as an integer value in expressions.

Assignment of a date-time field or date-time constant to a date field. The time components are removed.

- **Comparison and Subtraction.**

When a date-time value is compared with or subtracted from a date value, or a date value is compared with or subtracted from a date-time value, the date is converted to date-time with the time component set to midnight. They are then compared or subtracted as date-time values.

- **Function parameters.**

Simplified date functions can use either date or date-time values as their date parameters. Legacy user functions do not support this new functionality. The date-time functions (H functions) use date-time parameters and the new date functions use new dates, which are stored as offsets from a base date.

Recognition and use of date or date-time constants.

- Constants can be expressed as strings, without the DT operator.
- Constants are converted to or from date or date-time values in accordance with the field format they are compared with, subtracted from, or assigned to.
- Unless it is expressed in a non-ambiguous translated or formatted string format with proper delimiters (not as a numeric string or number), the recognition of a constant as a date depends on the format of its field counterpart.

In this case, the size in terms of the number of digits is strictly limited to at least six for a full component date or date-time value, (eight for a four-digit year), three for a partial component date, and one for a single component date.

- When numeric constants are used as function parameters and, therefore, do not have a field counterpart, they are recognized according to YYMD or YMD format. The only exception is a string with a single blank or the number zero which, in reports, will be

presented as a blank. Date offset constants are no longer allowed. Blank separators between digits in a string are also not supported.

For additional information about date and date-time formats, see the *ibi™ FOCUS® Describing Data* manual.

Assigning Date and Date-Time Values

The following request generates a date-time value using the `DT_CURRENT_DATETIME` function. It then assigns this value to a date field and assigns that date field to a date-time field.

```
TABLE FILE WFLITE
PRINT QUANTITY_SOLD NOPRINT AND COMPUTE
  DATETIME1/HYYMDm = DT_CURRENT_DATETIME(MILLISECOND);
  AS 'Date-Time 1'
COMPUTE
  DATE1/YYMD = DATETIME1;
  AS 'Date'
COMPUTE
  DATETIME2/HYYMDm = DATE1;
  AS 'Date-Time 2'
WHERE RECORDLIMIT EQ 20
ON TABLE SET PAGE NOLEAD
ON TABLE SET STYLE *
GRID=OFF,$
ENDSTYLE
END
```

The output is shown in the following image. The original date-time field has a non-zero time component. When assigned to the date field, the time component is removed. When that date is assigned to the second date-time field, a zero time component is added.

<u>Date-Time 1</u>	<u>Date</u>	<u>Date-Time 2</u>
2017/08/25 09:10:06.855000	2017/08/25	2017/08/25 00:00:00.000000
2017/08/25 09:10:06.855000	2017/08/25	2017/08/25 00:00:00.000000
2017/08/25 09:10:06.855000	2017/08/25	2017/08/25 00:00:00.000000
2017/08/25 09:10:06.855000	2017/08/25	2017/08/25 00:00:00.000000
2017/08/25 09:10:06.855000	2017/08/25	2017/08/25 00:00:00.000000
2017/08/25 09:10:06.855000	2017/08/25	2017/08/25 00:00:00.000000
2017/08/25 09:10:06.855000	2017/08/25	2017/08/25 00:00:00.000000
2017/08/25 09:10:06.855000	2017/08/25	2017/08/25 00:00:00.000000
2017/08/25 09:10:06.855000	2017/08/25	2017/08/25 00:00:00.000000
2017/08/25 09:10:06.855000	2017/08/25	2017/08/25 00:00:00.000000
2017/08/25 09:10:06.855000	2017/08/25	2017/08/25 00:00:00.000000
2017/08/25 09:10:06.855000	2017/08/25	2017/08/25 00:00:00.000000
2017/08/25 09:10:06.855000	2017/08/25	2017/08/25 00:00:00.000000
2017/08/25 09:10:06.855000	2017/08/25	2017/08/25 00:00:00.000000
2017/08/25 09:10:06.856000	2017/08/25	2017/08/25 00:00:00.000000
2017/08/25 09:10:06.856000	2017/08/25	2017/08/25 00:00:00.000000
2017/08/25 09:10:06.856000	2017/08/25	2017/08/25 00:00:00.000000
2017/08/25 09:10:06.856000	2017/08/25	2017/08/25 00:00:00.000000
2017/08/25 09:10:06.856000	2017/08/25	2017/08/25 00:00:00.000000

Comparing Date and Date-Time Values

The following request creates one date-time field and one date field. When QUANTITY_SOLD is 1, they have the same date value and the date-time field has a zero time component. When QUANTITY_SOLD is 2, they have different date values, and the date-time field has a zero time component. In all other cases, the date-time field has the current date with a non-zero time component, and the date field has the current date. The EQUAL1 field compares them to see if they compare as equal.

```
TABLE FILE WFLITE
PRINT QUANTITY_SOLD AS Quantity AND COMPUTE
  DATETIME1/HYYMDm = IF QUANTITY_SOLD EQ 1 THEN '2017/06/05'
    ELSE IF QUANTITY_SOLD EQ 2 THEN '2016/02/29'
    ELSE DT_CURRENT_DATETIME(MILLISECOND);
AS 'Date-Time'
```

```

COMPUTE
  DATE1/YYMD = IF QUANTITY_SOLD EQ 1 THEN '2017/06/05'
              ELSE IF QUANTITY_SOLD EQ 2 THEN '2015/12/30'
              ELSE DT_CURRENT_DATE();
  AS 'Date'
COMPUTE
  EQUAL1/A1 = IF DATETIME1 EQ DATE1 THEN 'Y' ELSE 'N';
  AS 'Equal?'
WHERE RECORDLIMIT EQ 12
ON TABLE SET PAGE NOLEAD
ON TABLE SET STYLE *
GRID=OFF,$
ENDSTYLE
END

```

The output is shown in the following image. When a date value is compared to a date-time value, the date is converted to a date-time value with the time component set to zero, and then the values are compared. Therefore, when QUANTITY_SOLD is 1, both the date components are equal and the time component of the date-time field is set to zero, so when the date is converted to a date-time value, they are equal. When QUANTITY_SOLD is 2, the date components are different, so they are not equal. When QUANTITY_SOLD is 3, the date components are the same, but the date-time field has a non-zero time component. Therefore, when the date field is converted to a date-time value with a zero time component and they are compared, they are not equal.

<u>Quantity</u>	<u>Date-Time</u>	<u>Date</u>	<u>Equal?</u>
1	2017/06/05 00:00:00.000000	2017/06/05	Y
1	2017/06/05 00:00:00.000000	2017/06/05	Y
1	2017/06/05 00:00:00.000000	2017/06/05	Y
2	2016/02/29 00:00:00.000000	2015/12/30	N
1	2017/06/05 00:00:00.000000	2017/06/05	Y
1	2017/06/05 00:00:00.000000	2017/06/05	Y
2	2016/02/29 00:00:00.000000	2015/12/30	N
1	2017/06/05 00:00:00.000000	2017/06/05	Y
1	2017/06/05 00:00:00.000000	2017/06/05	Y
1	2017/06/05 00:00:00.000000	2017/06/05	Y
3	2017/08/25 09:24:45.203000	2017/08/25	N
1	2017/06/05 00:00:00.000000	2017/06/05	Y

Specify the Order of Date Components in a Date-Time Field

```
SET DATEFORMAT = option
```

where:

option

Can be one of the following: MDY, DMY, YMD, or MYD. MDY is the default value for the U.S. English format.

Specifying a Date-Time Value

An external date-time value is a constant in character format from one of the following sources:

- A sequential data source.
- Typed by an application user at a terminal or workstation.
- Used in an expression in a WHERE, IF, DEFINE, or a COMPUTE.

A date-time constant typed by an application user at a terminal or workstation, or a date-time value as it appears in a character file has one of the following formats:

```
time_string [date_string]  
date_string [time_string]
```

A date-time constant in a COMPUTE, DEFINE, or WHERE expression must have one of the following formats:

```
DT(time_string [date_string])  
DT(date_string [time_string])
```

A date-time constant in an IF expression has one of the following formats:

```
'time_string [date_string]'
'date_string [time_string]'
```

If the value contains no blanks or special characters, the single quotation marks are not necessary. Note that the DT prefix is not supported in IF criteria.

where:

time_string

Cannot contain blanks. Time components are separated by colons, and may be followed by AM, PM, am, or pm. For example:

```
14:30:20:99      (99 milliseconds)
14:30
14:30:20.99      (99/100 seconds)
14:30:20.999999  (999999 microseconds)
02:30:20:500pm
```

Note that the second can be expressed with a decimal point or be followed by a colon:

- If there is a colon after the second, the value following it represents the millisecond. There is no way to express the microsecond or nanosecond using this notation.
- A decimal point in the second value indicates the decimal fraction of a second. A microsecond can be represented using six decimal digits. A nanosecond can be represented using nine decimal digits.

date_string

Can have one of the following three formats:

- **Numeric string format.** Is exactly four, six, or eight digits. Four-digit strings are considered to be a year (century must be specified). The month and day are set to January 1. Six and eight-digit strings contain two or four digits for the year, followed by two for the month, and then two for the day. Because the component order is fixed with this format, the DATEFORMAT setting described in [Specify the Order of Date Components in a Date-Time Field](#) is ignored.

If a numeric-string format longer than eight digits is encountered, it is treated as a combined date-time string in the Hn format. The following are examples of numeric string date constants:

```
99
1999
19990201
```

- **Formatted-string format.** Contains a one or two-digit day, a one or two-digit month, and a two or four-digit year separated by spaces, slashes, hyphens, or periods. All three parts must be present and follow the DATEFORMAT setting described in [Specify the Order of Date Components in a Date-Time Field](#). If any of the three fields is four digits, it is interpreted as the year, and the other two fields must follow the order given by the DATEFORMAT setting. The following are examples of formatted-string date constants:

```
1999/05/20
5 20 1999
99.05.20
1999-05-20
```

- **Translated-string format.** Contains the full or abbreviated month name. The year must also be present in four-digit or two-digit form. If the day is missing, day 1 of the month is assumed; if present, it can have one or two digits. If the string contains both a two-digit year and a two-digit day, they must be in the order given by the DATEFORMAT setting. For example:

```
January 6 2000
```



Note:

- The date and time strings must be separated by at least one blank space. Blank spaces are also permitted at the beginning and end of the date-time string or immediately before an am/pm indicator.
- In each date format, two-digit years are interpreted using the [F]DEFCENT and [F]YRTHRESH settings.

Assigning Date-Time Literals

The DT prefix can be used, although it is no longer required, in a COMPUTE, DEFINE, or WHERE expression to assign a date-time literal to a date-time field. For example:

```
DT2/HYYMDS = DT(20051226 05:45);
```

```
DT3/HYYMDS = DT(2005 DEC 26 05:45);
```

```
DT4/HYYMDS = DT(December 26 2005 05:45);
```

Specifying the Order of Date Components for a Date-Time Field

The following request sets DATEFORMAT to MYD:

```
SET DATEFORMAT = MYD
DEFINE FILE EMPLOYEE
DTFLDYMD/HYYMDI = DT(APR 04 05);
END

TABLE FILE EMPLOYEE
PRINT CURR_SAL DTFLDYMD
END
```

The output shows that the natural date literal 'APR 04 05' is interpreted as April 5, 1904:

CURR_SAL	DTFLDYMD
-----	-----
\$11,000.00	1904/04/05 00:00
\$13,200.00	1904/04/05 00:00
\$18,480.00	1904/04/05 00:00
\$9,500.00	1904/04/05 00:00
\$29,700.00	1904/04/05 00:00
\$26,862.00	1904/04/05 00:00
\$21,120.00	1904/04/05 00:00
\$18,480.00	1904/04/05 00:00
\$21,780.00	1904/04/05 00:00
\$16,100.00	1904/04/05 00:00
\$9,000.00	1904/04/05 00:00
\$27,062.00	1904/04/05 00:00

Reading Date-Time Values From a Transaction File

The DTTRANS comma-delimited transaction file has an ID field and a date-time field that contains both the date (as eight characters) and time (in the format hour:minute:second):

```
01, 20000101 02:57:25,$
02, 19991231 14:05:35,$
```

Because the transaction file contains the dates in numeric string format, the DATEFORMAT setting is not used, and the dates are entered in YMD order.

The following transaction file is also valid. It contains formatted string dates that comply with the default DATEFORMAT setting, MDY:

```
01, 01/01/2000 02:57:25,$
02, 12/31/1999 14:05:35,$
```

The following Master File describes the FOCUS data source named DATETIME, which receives these values:

```
FILE=DATETIME,      SUFFIX=FOC      ,$
SEGNAME=DATETIME,  SEGTYPE=S0      ,$
FIELD=ID, ID,      USAGE = I2      ,$
FIELD=DT1, DT1,    USAGE=HYMDS     ,$
```

Using a Date-Time Value in a COMPUTE Command

```
TABLE FILE EMPLOYEE
PRINT LAST_NAME FIRST_NAME AND COMPUTE
NEWSAL/D12.2M = CURR_SAL + (0.1 * CURR_SAL);
RAISETIME/HYYMDIA = DT(20000101 09:00AM);
WHERE CURR_JOBCODE LIKE 'B%'
END
```

The output is:

LAST_NAME	FIRST_NAME	NEWSAL	RAISETIME
SMITH	MARY	\$14,520.00	2000/01/01 9:00AM

JONES	DIANE	\$20,328.00	2000/01/01	9:00AM
ROMANS	ANTHONY	\$23,232.00	2000/01/01	9:00AM
MCCOY	JOHN	\$20,328.00	2000/01/01	9:00AM
BLACKWOOD	ROSEMARIE	\$23,958.00	2000/01/01	9:00AM
MCKNIGHT	ROGER	\$17,710.00	2000/01/01	9:00AM

Using a Date-Time Value in WHERE Criteria

In a WHERE clause, a date-time constant must use the DT() format:

```
TABLE FILE VIDEOTR2
PRINT CUSTID TRANSDATE
WHERE TRANSDATE GT DT(2000/01/01 02:57:25)
END
```

The output is:

CUSTID	TRANSDATE
-----	-----
1118	2000/06/26 05:45
1237	2000/02/05 03:30

Using a Date-Time Value in IF Criteria

In an IF clause, a date-time constant must be enclosed in single quotation marks if it contains any blanks:

```
TABLE FILE VIDEOTR2
PRINT CUSTID TRANSDATE
IF TRANSDATE GT '2000/01/01 02:57:25'
END
```

The DT prefix for a date-time constant is not supported in an IF clause.

The output is:

```

CUSTID  TRANSDATE
-----  -
1118    2000/06/26 05:45
1237    2000/02/05 03:30

```

Specifying Universal Date-Time Input Values

With DTSTANDARD settings of STANDARD and STANDARDU, the following date-time values can be read as input:

Input Value	Description
14:30[:20,99]	Comma separates time components instead of period
14:30[:20.99]Z	Universal time
15:30[:20,99]+01 15:30 [:20,99]+0100 15:30 [:20,99]+01:00	Each of these is the same as above in Central European Time
09:30[:20.99]-05	Same as above in Eastern Standard Time

Note that these values are stored identically internally with the STANDARDU setting. With the STANDARD setting, everything following the Z, +, or - is ignored.

Manipulating Date-Time Values

Any two date-time values can be compared, even if their lengths do not match.

If a date-time field supports missing values, fields that contain the missing value have a greater value than any date-time field can have. Therefore, in order to exclude missing

values from the report output when using a GT or GE operator in a selection test, it is recommended that you add the additional constraint field NE MISSING to the selection test:

```
date_time_field {GT|GE} date_time_value AND date_time_field NE MISSING
```

Assignments are permitted between date-time formats of equal or different lengths. Assigning a 10-byte date-time value to an 8-byte date-time value truncates the microsecond portion (no rounding takes place). Assigning a short value to a long one sets the low-order three digits of the microseconds to zero.

Other operations, including concatenation, EDIT, and LIKE on date-time operands are not supported. Prefix operators that work with alphanumeric fields are supported.

Testing for Missing Date-Time Values

Consider the DATETIM2 Master File:

```
FILE=DATETIM2, SUFFIX=FOC , $
SEGNAME=DATETIME, SEGTYPE=S0 , $
FIELD=ID, ID, USAGE = I2 , $
FIELD=DT1, DT1, USAGE=HYMDS, MISSING=ON, $
```

Field DT1 supports missing values. Consider the following request:

```
TABLE FILE DATETIM2
PRINT ID DT1
END
```

The resulting report output shows that in the instance with ID=3, the field DT1 has a missing value:

```
ID  DT1
--  ---
 1  2000/01/01 02:57:25
 2  1999/12/31 00:00:00
 3  .
```

The following request selects values of DT1 that are greater than 2000/01/01 00:00:00 and are not missing:

```
TABLE FILE DATETIM2
PRINT ID DT1
  WHERE DT1 NE MISSING AND DT1 GT DT(2000/01/01 00:00:00);
END
```

The missing value is not included in the report output:

```
ID  DT1
--  ---
 1  2000/01/01 02:57:25
```

Assigning a Different Usage Format to a Date-Time Column

Consider the following request using the VIDEOTR2 data source:

```
TABLE FILE VIDEOTR2
PRINT CUSTID TRANSDATE AND COMPUTE
  DT2/HYYMDH = TRANSDATE;
  T1/HHIS = TRANSDATE;
WHERE DATE EQ 2000
END
```

The output is:

CUSTID	TRANSDATE	DT2	T1
-----	-----	---	--
1118	2000/06/26 05:45	2000/06/26 05	05:45:00
1237	2000/02/05 03:30	2000/02/05 03	03:30:00

Creating a Character Expression

A character expression uses alphanumeric constants, fields, concatenation operators, IF-THEN-ELSE logic, or functions to derive an alphanumeric value.

Both text and alphanumeric fields can be assigned values stored in text fields or alphanumeric expressions in TABLE COMPUTE, MODIFY COMPUTE, and DEFINE commands.

If an alphanumeric field is assigned the value of a text field that is too long for the alphanumeric field, the value is truncated before being assigned to the alphanumeric field.

A character expression can consist of:

- An alphanumeric constant (character string) enclosed in single quotation marks. For example:

```
COMPUTE STATE/A2 = 'NY';
```

- A combination of alphanumeric fields and/or constants joined by the concatenation operator. For example:

```
DEFINE FILE EMPLOYEE TITLE/A19 = 'DR. ' | LAST_NAME;
END
```

- An alphanumeric function. For example:

```
DEFINE FILE EMPLOYEE INITIAL/A1 = EDIT(FIRST_NAME, '9$$$$$$$$');
END
```

- A text field.

i Note:

- Non-printable characters are not supported in an alphanumeric constant.
- Two consecutive single quotation marks represent a null value with format A1V and an actual length of 0 (zero), when the field has MISSING ON.

Embedding a Quotation Mark in a Quote-Delimited Literal String

Under certain conditions, you can use quote-delimited strings containing embedded quotation marks. Within the string, you can use either one single quotation mark or two contiguous single quotation marks to represent the single quotation mark. Both are interpreted as a single quotation mark.

You can use quote-delimited strings in the following instances:

- WHERE and IF criteria containing multiple quotes.
- WHERE criteria containing: *fieldname* {IS, IS-NOT, IN, IN FILE, or NOT IN FILE}.
- EDIT.
- WHEN *fieldname* EQ an embedded quote in a literal.
- DEFINE commands.
- DEFINE attributes in Master Files.
- Database Administrator (DBA) attributes in Master Files (for example, VALUE = *fieldname* EQ an embedded quote in a literal).
- ACCEPT=, DESCRIPTION=, TITLE= attributes in Master Files.
- AS.
- DECODE.

Specifying the Data Value O'BRIEN in a Quote-Delimited Literal String

The following example illustrates the use of quotation marks for the correct interpretation of the data value O'BRIEN:

```
TABLE FILE VIDEOTRK  
PRINT LASTNAME  
WHERE LASTNAME IS 'O'BRIEN'  
END
```

Concatenating Character Strings

You can write an expression that concatenates two or more alphanumeric constants and/or fields into a single character string. This concatenation operator has two forms, as shown in the following table:

Symbol	Represents	Description
	Weak concatenation	Preserves trailing blanks.
	Strong concatenation	Moves trailing blanks to the end of a concatenated string.

Concatenating Character Strings

The following example uses the EDIT function to extract the first initial from a first name. It then uses both strong and weak concatenation to produce the last name, followed by a comma, followed by the first initial, followed by a period:

```
DEFINE FILE EMPLOYEE
FIRST_INIT/A1 = EDIT(FIRST_NAME, '9$$$$$$$$');
NAME/A19 = LAST_NAME ||(' , ' | FIRST_INIT |'.');
END
```

```
TABLE FILE EMPLOYEE
PRINT NAME WHERE LAST_NAME IS 'BANNING'
END
```

The output is:

```
NAME
----
BANNING, J.
```

The request evaluates the expressions as follows:

1. The EDIT function extracts the initial J from FIRST_NAME.
2. The expression in parentheses returns the value:

```
, J.
```

3. LAST_NAME is concatenated to the string derived in step 2 to produce:

```
Banning, J.
```

While LAST_NAME has the format A15 in the EMPLOYEE Master File, strong concatenation suppresses the trailing blanks. Regardless of the suppression or inclusion of blanks, the resulting field name, NAME, has a length of 19 characters (A19).

Using IF-THEN-ELSE Logic in a Character Expression

The following request uses IF-THEN-ELSE logic to determine what characters to concatenate to MOVIECODE in order to compute NEWCODE.

```
TABLE FILE MOVIES
PRINT COPIES
MOVIECODE
COMPUTE
NEWCODE/A20 = MOVIECODE |(IF MOVIECODE CONTAINS 'DIS' THEN 'NEY;' ELSE
';');
BY CATEGORY
WHERE CATEGORY EQ 'CHILDREN'
ON TABLE SET PAGE NOLEAD
ON TABLE SET STYLE *
GRID=OFF,$
ENDSTYLE
END
```

The output is shown in the following image. If MOVIECODE contains the characters 'DIS', NEWCODE is generated by concatenating the characters 'NEY;', otherwise NEWCODE is generated by concatenating the character ';'.

<u>CATEGORY</u>	<u>COPIES</u>	<u>MOVIECODE</u>	<u>NEWCODE</u>
CHILDREN	1	031KKV	031KKV;
	2	043DIS	043DISNEY;
	1	093WOR	093WOR;
	2	306DIS	306DISNEY;
	1	309RAN	309RAN;
	1	387PLA	387PLA;
	1	476DIS	476DISNEY;
	3	732DIS	732DISNEY;

Creating a Variable Length Character Expression

As an alphanumeric type, an *AnV* field can be used in arithmetic and logical expressions in the same way that the *An* type is used.

- An expression that contains *AnV* type fields can be of either the *AnV* or *An* type.
- The type that results from the expression depends on the specific type of operation, as described in subsequent sections.

i Note: Because *AnV* fields have two bytes of overhead and there is additional processing required to strip them, the *AnV* format is not recommended for use in non-relational data sources.

Using Concatenation With *AnV* Fields

If either of the operands in a concatenation between two fields is an *AnV* field, variable length alphanumeric rules are used to perform the concatenation:

- The size of the concatenated string is the sum of the sizes of the operands.
- For weak concatenation, the actual length of the concatenated string is the sum of the two actual lengths of the input strings.

- For strong concatenation, the actual length stored in an AnV field of the concatenated string is the sum of the actual length of the first input string minus its number of trailing blanks plus the actual length of the second string.
- For any An field in the concatenation, the size and length are equal.
- Two consecutive single quotation marks represent a null value with format $A1V$ and an actual length of 0 (zero), when the field has $MISSING ON$.

Using the EDIT Function With AnV Fields

The following expression results in an AnV format only when x has an AnV format.

```
EDIT(x,mask)
```

The actual length of the result is the number of characters in the *mask* other than '\$'.

Note that an actual length of zero may result.

$EDIT(x)$ can be used to convert an AnV field to an integer value when x has an AnV format.

Using CONTAINS and OMITS With AnV Fields

The only difference in evaluation of the $CONTAINS$ and $OMITS$ operators with AnV fields occurs when one of the operands has an actual length of zero.

In the following examples, the field Z has an actual length of zero, but X and Y do not:

Expression	Result
Z CONTAINS Y	FALSE
X CONTAINS Z	TRUE

Expression	Result
Z CONTAINS Z	TRUE
Z OMTS Y	TRUE
X OMTS Z	FALSE
Z OMTS Z	FALSE

Using LIKE With *AnV* Fields

The only difference in evaluation of the following expression occurs when *x* has an actual length of zero:

```
x LIKE mask ...
```

In the following example, the field instance *Z* has an actual length of zero:

```
Z LIKE mask ...
```

This expression evaluates to TRUE only when the mask consists exclusively of percent ('%') signs.

Note that no other mask can evaluate to an empty string. Even the mask in the following expression has a length of one, and therefore the expression evaluates as FALSE:

```
Z LIKE ''
```

Using the EQ, NE, LT, GT, LE, and GE Operators With *AnV* Fields

As with *An* type fields, operations are evaluated on the assumption that the shorter operand is padded with blanks.

Therefore, even an empty *AnV* field, Z, is compared as a field consisting of all blanks.

In the following examples, Z is an empty *AnV* field instance and X is an *AnV* field instance that is not empty and contains non-blank characters:

Expression	Result
Z EQ Z Z GE Z Z LE Z	TRUE
Z NE Z Z LT Z Z GT Z	FALSE
Z EQ X	FALSE
Z NE X	TRUE
Z LT X	TRUE
Z GT X	FALSE
Z LE X	TRUE

Expression	Result
Z GE X	FALSE
X EQ Z	FALSE
X NE Z	TRUE
X LT Z	FALSE
X GT Z	TRUE
X LE Z	FALSE
X GE Z	TRUE

Using the DECODE Function With AnV Fields

```
DECODE alphafield (value 'result'...
```

The use of either an *An* or *AnV* field with DECODE causes a result of type *An* as long as the *result* part of the value-result pairs is provided as a constant. (Constants are type *An*.)

Using the Assignment Operator With AnV Fields

There are three situations to consider when using the assignment operator with the *AnV* format: *AnV* data type on the right-hand side only, *AnV* data type on both sides, and *AnV*

data type on the left side only.

```
fld/An = AnV_type_expression;
```

- The actual length of the evaluated expression is lost on assignment to the *An* field.
- The size of the *AnV* result does not prevent assignment to a shorter *An* format field:
 - If the result of the expression has an actual length that is shorter than the length of the field on the left side of the assignment operator, the result is padded with blanks.
 - If the result of the expression has an actual length that is longer than the length of the field on the left side of the assignment operator, the result is truncated.

```
fld/AnV = AnV_type_expression;
```

- The length of the result is assigned as the length of the field on the left of the assignment operator unless it exceeds the field's declared size. In this case, the length assigned is the declared size (*n*).
- The size of the *AnV* evaluation result does not prevent assignment to a shorter *AnV* field:
 - If the length of the result of the expression is shorter than the size of the field on the left side of the assignment operator, the result is padded with blanks.
 - If the result of the expression has an actual length that is longer than the size of the field on the left side of the assignment operator, the result is truncated.

```
fld/AnV = An_type_expression;
```

- The length of the field on the left side of the assignment operator is assigned equal to its size (*n*).
- The actual length of the result is verified against the size *n* declared for the *AnV* field. An error is generated if the result is longer than *n*.

Creating a Logical Expression

A logical expression determines whether a particular condition is true. There are two kinds of logical expressions: relational and Boolean. The entities to be compared determine the kind of expression used:

- A relational expression returns TRUE or FALSE based on a comparison of two individual values (either field values or constants).
- A Boolean expression returns TRUE or FALSE based on the outcome of two or more relational expressions.

You can use a logical expression to assign a value to a numeric field. If the expression is true, the field receives the value 1. If the expression is false, the field receives the value 0.

Logical Operators

The following is a list of common operators used in logical expressions. For information on relational operators and additional operators available for record selection using WHERE and IF, see [Selecting Records for Your Report](#).

Operator	Description
EQ	Returns the value TRUE if the value on the left is equal to the value on the right.
NE	Returns the value TRUE if the value on the left is not equal to the value on the right.
GE	Returns the value TRUE if the value on the left is greater than or equal to the value on the right.
GT	Returns the value TRUE if the value on the left is greater than the value on the right.
LE	Returns the value TRUE if the value on the left is less than or equal to the value on the right.

Operator	Description
LT	Returns the value TRUE if the value on the left is less than the value on the right.
AND	Returns the value TRUE if both operands are true.
OR	Returns the value TRUE if either operand is true.
NOT	Returns the value TRUE if the operand is false.
CONTAINS	Contains the specified character strings.
OMITS	Omits the specified character strings.
IS MISSING	Returns the value TRUE if the field is missing.
IS-NOT MISSING	Returns the value TRUE if the field is not missing.

Write a Relational Expression

Any of the following are valid for a relational expression:

```
value {EQ|NE} valuevalue {LE|LT} valuevalue {GE|GT} valuecharacter_value
{CONTAINS|OMITS} character_value
```

where:

value

Is a field value or constant.

character_value

Is a character string. If it contains blanks, the string must be enclosed in single quotation marks.

Write a Boolean Expression

Either of the following is valid for a Boolean expression:

```
(relational_expression) {AND|OR} (relational_expression)  
NOT (logical_expression)
```

where:

relational_expression

Is an expression based on a comparison of two individual values (either field values or constants).

logical_expression

Is an expression that evaluates to the value TRUE or FALSE. If the expression is true, the field receives the value 1. If the expression is false, the field receives the value 0. The expression must be enclosed in parentheses.

Creating a Conditional Expression

A conditional expression assigns a value based on the result of a logical expression. The assigned value can be numeric or alphanumeric.

i Note: Unlike selection criteria using IF, all alphanumeric values in conditional expressions must be enclosed in single quotation marks. For example, IF COUNTRY EQ 'ENGLAND'.

Write a Conditional Expression

```
IF expression1 THEN expression2 [ELSE expression3]
```

where:

expression1

Is the expression that is evaluated to determine whether the field is assigned the value of *expression2* or of *expression3*.

expression2

Is an expression that results in a format compatible with the format assigned to the field. It may be a conditional expression, in which case you must enclose it in parentheses.

expression3

Is an expression that results in a format compatible with the format assigned to the field. Enclosure of the expression in parentheses is optional.

ELSE

Is optional, along with *expression3*. However, if you do not specify an ELSE condition and the IF condition is not met, the value is taken from the last evaluated condition. Therefore, the results may not be what you expect if you do not include an ELSE condition.

Note that the final sorted report may display mixed values. This depends on whether a DEFINE or a COMPUTE is used, and if a data record is evaluated before or after aggregation.

The expressions following THEN and ELSE must result in a format that is compatible with the format assigned to the field. Each of these expressions may itself be a conditional expression. However, the expression following IF may not be an IF ... THEN ... ELSE expression (for example, IF ... IF ...).

Supplying a Value With a Conditional Expression

The following example uses a conditional expression to assign the value NONE to the field BANK_NAME when it is missing a data value (that is, when the field has no data in the data

source):

```
DEFINE FILE EMPLOYEE
BANK_NAME/A20 = IF BANK_NAME EQ ' ' THEN 'NONE'
ELSE BANK_NAME;
END

TABLE FILE EMPLOYEE
PRINT CURR_SAL AND BANK_NAME
BY EMP_ID BY BANK_ACCT
END
```

The output is:

EMP_ID	BANK_ACCT	CURR_SAL	BANK_NAME
-----	-----	-----	-----
071382660		\$11,000.00	NONE
112847612		\$13,200.00	NONE
117593129	40950036	\$18,480.00	STATE
119265415		\$9,500.00	NONE
119329144	160633	\$29,700.00	BEST BANK
123764317	819000702	\$26,862.00	ASSOCIATED
126724188		\$21,120.00	NONE
219984371		\$18,480.00	NONE
326179357	122850108	\$21,780.00	ASSOCIATED
451123478	136500120	\$16,100.00	ASSOCIATED
543729165		\$9,000.00	NONE
818692173	163800144	\$27,062.00	BANK ASSOCIATION

Defining a True or False Condition

You can define a true or false condition and then test it to control report output. The following example assigns the value TRUE to the field MYTEST if either of the relational expressions in parentheses is true. It then tests the value of MYTEST:

```
DEFINE FILE EMPLOYEE
MYTEST= (CURR_SAL GE 11000) OR (DEPARTMENT EQ 'MIS');
END

TABLE FILE EMPLOYEE
PRINT CURR_SAL AND DEPARTMENT
BY EMP_ID
```

```
IF MYTEST IS TRUE  
END
```

The output is:

EMP_ID	CURR_SAL	DEPARTMENT
-----	-----	-----
071382660	\$11,000.00	PRODUCTION
112847612	\$13,200.00	MIS
117593129	\$18,480.00	MIS
119329144	\$29,700.00	PRODUCTION
123764317	\$26,862.00	PRODUCTION
126724188	\$21,120.00	PRODUCTION
219984371	\$18,480.00	MIS
326179357	\$21,780.00	MIS
451123478	\$16,100.00	PRODUCTION
543729165	\$9,000.00	MIS
818692173	\$27,062.00	MIS



Note: Testing for a TRUE or FALSE condition is valid only with the IF command. It is not valid with WHERE.

Customizing Tabular Reports

FOCUS provides a variety of formatting options that enable you to customize your reports. For example, you can specify page breaks, rename report column titles, and add subfoot text to the bottom of pages.

i Note: FOCUSformats report automatically using defaults based on the formats of fields. However, you can override these defaults to customize your report format to suit your individual requirements.

If you save your report output in HTML, Excel 2000, PDF, or PostScript format, you have many additional formatting options that are described in [Styling Reports](#).

Producing Headings and Footings

You can use a variety of headings and footings to clarify the information presented in your reports. The following diagram illustrates the available options:

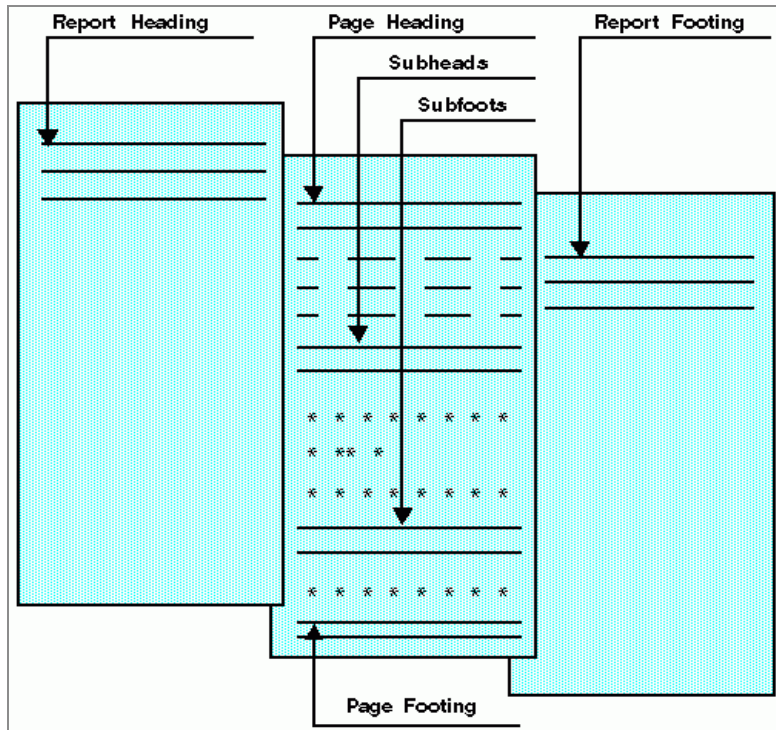

Limits for Headings and Footings

The following limitations apply to report headings and footings, page headings and footings, and sort headings and footings:

- In a single report, there can be a maximum of 32K characters for all types of heading and footing text.
- The maximum number of sort headings plus sort footings in one request is 64.
- The maximum limit of nested headings is 64.
- If your code for a single heading or footing line is broken into multiple lines in the report request, you can indicate that they are all a single line of heading using the <0X spot marker. For more information, see [Customizing Reports With SET Parameters](#).
- The maximum number of objects per line in a heading or footing is 128.
- For PDF and Postscript reports, the heading or footing lines must fit within the maximum report width to be displayed properly. Also, in order for the report body to be displayed, the number of heading or footing lines must leave room on the page

for at least one detail line (including column titles).

Report and Page Headings

A report heading is text that appears at the top of the first page of a report. A page heading is text that appears at the top of every page of a report. In general, the heading is composed of text that you supply in your report request, enclosed in double quotation marks.

i Note: If the end quotation mark of the heading text is omitted, all subsequent lines of the request are treated as part of the heading.

Create a Report Heading

To create a report heading, the syntax is:

```
ON TABLE [PAGE-BREAK AND] SUBHEAD  
"text"
```

where:

PAGE-BREAK

Is an optional phrase that positions the report heading on a separate page, which is then followed by the first page of the report itself. If you do not use PAGE-BREAK, the report heading appears on Page 1, followed immediately by the page heading and column titles.

text

Is text that you supply between quotation marks that appears as a heading. The text must be on a line by itself and must immediately follow the SUBHEAD command.

Create a Page Heading

To place a heading on every page of the report, the syntax is:

```
TABLE FILE filename  
[HEADING [CENTER]]  
"text"
```

where:

HEADING

Is optional if you place the text before the first display command; otherwise, it is required to identify the text as a heading. The command CENTER centers the heading over the text automatically.

text

Is the text placed within quotation marks that appears on every page. The text can be split over multiple lines, and must begin on the line immediately following the HEADING command.

If you supply two or more text lines between quotation marks, the lines are automatically adjusted into pairs to provide coverage across the printed page.

To position heading text, use spot markers as described in [Using Data in Headings and Footings](#).

Creating a Report Heading

The following request creates a report heading:

```
TABLE FILE EMPLOYEE  
SUM GROSS  
BY DEPARTMENT BY HIGHEST PAY_DATE  
ON TABLE PAGE-BREAK AND SUBHEAD  
"PLEASE RETURN THIS TO MARY SMITH"  
END
```

The first two pages of output follow (only the page preceding the body of the report has the subhead):

```

PAGE 1
PLEASE RETURN THIS TO MARY SMITH
PAGE 2
DEPARTMENT      PAY_DATE      GROSS
-----
MIS              82/08/31      $9,000.00
                 82/07/30      $7,460.00
                 82/06/30      $7,460.00
                 82/05/28      $6,649.51
                 82/04/30      $5,890.84
                 82/03/31      $3,247.75
                 82/02/26      $3,247.75
                 82/01/29      $3,247.75
                 81/12/31      $2,147.75
                 81/11/30      $2,147.75

```

```

PRODUCTION      82/08/31      $9,523.84
                 82/07/30      $7,048.84
                 82/06/30      $7,048.84
                 82/05/28      $7,048.84
                 82/04/30      $4,959.84
                 82/03/31      $4,959.84
                 82/02/26      $4,959.84

```

Creating a Page Heading

The following request prints a heading on each page:

```

TABLE FILE EMPLOYEE
"ACCOUNT REPORT FOR DEPARTMENT"
PRINT CURR_SAL BY DEPARTMENT BY HIGHEST BANK_ACCT
BY EMP_ID
ON DEPARTMENT PAGE-BREAK
END

```

This request produces the following two-page report:

```

PAGE 1
ACCOUNT REPORT FOR DEPARTMENT
DEPARTMENT      BANK_ACCT      EMP_ID      CURR_SAL
-----

```

MIS	163800144	818692173	\$27,062.00
	122850108	326179357	\$21,780.00
	40950036	117593129	\$18,480.00
		112847612	\$13,200.00
		219984371	\$18,480.00
		543729165	\$9,000.00

PAGE 2

ACCOUNT REPORT FOR DEPARTMENT

DEPARTMENT	BANK_ACCT	EMP_ID	CURR_SAL
-----	-----	-----	-----
PRODUCTION	819000702	123764317	\$26,862.00
	136500120	451123478	\$16,100.00
	160633	119329144	\$29,700.00
		071382660	\$11,000.00
		119265415	\$9,500.00
		126724188	\$21,120.00

Creating a Multi-Line Heading

The following request creates a two-line report heading:

```
TABLE FILE PROD
"  DETAIL LISTING OF AREA SALES
  DISTRIBUTION"
"   FIRST QUARTER OF YEAR
  BRANCH MANAGERS"
BY PROD_CODE NOPRINT
END
```

The report heading across the top of each page appears as:

```
DETAIL LISTING OF AREA SALES
DISTRIBUTION
  FIRST QUARTER OF YEAR
BRANCH MANAGERS
```

DISTRIBUTION and BRANCH MANAGERS are on the far right of the report because of trailing blanks in the procedure. The open and closing quote marks indicate the length of the text. To avoid extra blanks, code <0X at the end of the line to be continued. For more information, see [Positioning Text](#).

Report and Page Footings

A report footing is text that appears at the bottom of the last page of a report. A page footing is text that appears on the bottom of every page of a report. In general, the footing is composed of text that you can supply between quotation marks in a report request.

i Note: If the ending quotation mark of the footing text is omitted, all subsequent lines of the request are treated as part of the footing.

Create a Report Footing

To place a footing on the last page of the report, the syntax is:

```
ON TABLE [PAGE-BREAK AND] SUBFOOT  
"text"
```

where:

PAGE-BREAK

Is an optional phrase that positions the report footing on the last page by itself. If not used, the report footing appears as the last line on the report.

i Note: If PAGE-BREAK is specified in the BY phrase and not in the ON TABLE phrase, the report footing appears as the last line on the last page of the report.

text

Is the text you supply in quotation marks that appears as a footing. The text begins on the line following the keyword SUBFOOT.

Create a Page Footing

To display a footing on every page of a report, the syntax is:

```
FOOTING [CENTER] [BOTTOM]
"text"
```

where:

FOOTING

Is the keyword that identifies the text as a footing.

CENTER

Centers the footing automatically.

BOTTOM

Places the footing at the bottom of the page. If BOTTOM is not specified, the footing text appears two lines below the report.

text

Is the text you place within quotation marks that appears on every page.

Creating a Page Footing

The following request creates a page footing:

```
TABLE FILE CAR
WRITE SALES BY COUNTRY
FOOTING
"THIS IS HOW A FOOTNOTE IS ADDED TO EACH"
"PRINTED PAGE"
END
```

The output is:

COUNTRY	SALES
-----	-----
ENGLAND	12000
FRANCE	0
ITALY	30200
JAPAN	78030
W GERMANY	88190

THIS IS HOW A FOOTNOTE IS ADDED TO EACH PRINTED PAGE

Creating Multiple Conditional Headings and Footings

A TABLE request can have more than one page heading or footing. For each heading or footing, a WHEN clause against the data being retrieved can determine whether the heading or footing displays on the report output.

In a heading, the data for the WHEN clause and data field values displayed in the heading are based on the first line on the page. In a footing, the data for the WHEN clause and the data field values displayed in the footing are based on the last line on the page.

The CONDITION StyleSheet attribute enables you to identify a specific WHEN clause, so that you can style each heading or footing separately.

Specify a Heading or Footing With a WHEN Clause

```
{HEADING [CENTER] | FOOTING}  
"text_and_data1"  
.  
.  
.  
"text_and_datan"  
WHEN expression
```

where:

text_and_data1, text_and_datan

Is the text and data for each heading or footing line.

expression

Is an expression that resolves to TRUE or FALSE (1 or 0). If its value resolves to TRUE, the heading or footing is displayed. If the expression resolves to FALSE, the heading or footing is not displayed.

Usage Notes for Multiple Headings

- HEADING CENTER and FOOTING CENTER apply only to the specific heading or footing in which they are specified.
- A request can have a total of 120 headings, 120 footings, 120 subheadings, and 120 subfootings.
- Once you use the BOTTOM option on a footing, all subsequent footings also go to the bottom of the page.

Style a Specific Heading or Footing

```
TYPE = {HEADING|FOOTING}, CONDITION = n, ... , $
```

where:

n

Is the number of the WHEN condition in the heading or footing from top to bottom. If not specified, formatting applies to all headings and footings.

Using Multiple Headings With WHEN Clauses

The following request against the EMPLOYEE data source displays a page for each employee with salary and job code information for that employee. If the employee is female, the page starts with a heading that refers to the employee as Ms. If the employee is male, the page starts with a heading that refers to the employee as Mr. If the department is MIS, the signature is **Barbara Cross**. If the department is PRODUCTION, the signature is **John Banning**.

```

DEFINE FILE EMPLOYEE
GENDER/A1 = DECODE FIRST_NAME(ALFRED 'M' RICHARD 'M' JOHN 'M'
    ANTHONY 'M' ROGER 'M' MARY 'F' DIANE 'F' JOAN 'F' ROSEMARIE 'F'
    BARBARA 'F');
MIXEDNAME/A15 = LCWORD(15, LAST_NAME, MIXEDNAME);
NAME/A16 = MIXEDNAME||',';
END

TABLE FILE EMPLOYEE
PRINT LAST_NAME NOPRINT GENDER NOPRINT          NAME NOPRINT
HEADING
"Dear Ms. <NAME"
    WHEN GENDER EQ 'F';
HEADING
"Dear Mr. <NAME>"
    WHEN GENDER EQ 'M';
HEADING
" "
HEADING
"This is to inform you that your current salary is "
"<CURR_SAL and your job code is <CURR_JOBCODE>."
" "
"Sincerely,"
HEADING
"Barbara Cross "
    WHEN DEPARTMENT EQ 'MIS';
HEADING
"John Banning  "
    WHEN DEPARTMENT EQ 'PRODUCTION' ;
WHERE LAST_NAME NE 'BANNING' OR 'CROSS'
BY EMP_ID NOPRINT PAGE-BREAK
ON TABLE SET PAGE NOPAGE
END

```

The first page of output is for a male in the PRODUCTION department.

```

Dear Mr. Stevens,

This is to inform you that your current salary is
    $11,000.00 and that A07 is your job code.

Sincerely,
John Banning

```

The second page of output is for a female in the MIS department.

Dear Ms. Smith,

This is to inform you that your current salary is
\$13,200.00 and that B14 is your job code.

Sincerely,
Barbara Cross

Styling Multiple Headings With WHEN

The following request displays a page for each employee with salary and job code information for that employee. The first WHEN condition applies if the employee is female. The second WHEN condition applies if the employee is male. The third WHEN condition applies if the department is MIS. The fourth WHEN condition applies if the department is PRODUCTION. The StyleSheet declarations include styling elements for the second and third conditions.

```

DEFINE FILE EMPLOYEE
  GENDER/A1 = DECODE FIRST_NAME(ALFRED 'M' RICHARD 'M' JOHN 'M'
    ANTHONY 'M' ROGER 'M' MARY 'F' DIANE 'F' JOAN 'F' ROSEMARIE 'F'
    BARBARA 'F');
  MIXEDNAME/A15 = LCWORD(15, LAST_NAME, MIXEDNAME);
  NAME/A16 = MIXEDNAME||',';
  END

TABLE FILE EMPLOYEE
  PRINT LAST_NAME NOPRINT GENDER NOPRINT NAME NOPRINT
  HEADING
  "Dear Ms. <NAME>"
    WHEN GENDER EQ 'F';
  HEADING
  "Dear Mr. <NAME>"
    WHEN GENDER EQ 'M';
  HEADING
  " "
  HEADING
  "This is to inform you that your current salary is "
  "<CURR_SAL and your job code is <CURR_JOBCODE>."
  " "
  "Sincerely,"
  HEADING
  "Barbara Cross "
```

```

    WHEN DEPARTMENT EQ 'MIS';
HEADING
"John Banning  "
    WHEN DEPARTMENT EQ 'PRODUCTION' ;
WHERE LAST_NAME NE 'BANNING' OR 'CROSS'
BY EMP_ID NOPRINT PAGE-BREAK
ON TABLE SET PAGE NOPAGE
ON TABLE HOLD FORMAT PDF
ON TABLE SET STYLE *
TYPE=HEADING, CONDITION=2, STYLE=ITALIC,$
TYPE=HEADING, CONDITION=3, STYLE=BOLD,$
ENDSTYLE
END

```

In the StyleSheet for the request, heading lines displayed because of the first condition are in an italic typeface and heading lines displayed because of the third condition are in a bold typeface.

The first page of output is for a male employee, so the greeting line is in an italic typeface.

```

Dear Mr. Stevens,

This is to inform you that your current salary is
    $11,000.00 and that A07 is your job code.

Sincerely,
John Banning

```

The second page of output is for an employee in the MIS department, so the signature line is in a bold typeface.

```

Dear Ms. Smith,

This is to inform you that your current salary is
    $13,200.00 and that B14 is your job code.

Sincerely,
Barbara Cross

```

Subheads and Subfoots

A subhead is text that can be placed before the sort field values change. A subfoot is text that can be placed after the sort field values change. You can use NEWPAGE on a subheading or subfooting to start a new page after the subheading or before the

subfooting. It separates the subheading or subfooting from its associated data but does not separate the data from the next subheading or prior subfooting.

In conjunction with the PAGE-BREAK command, this enables you to create a cover page for each section of a report.



Note:

- If the ending quotation mark of the subheading text is omitted, all subsequent lines of the request are treated as part of the subheading.
- If the ending quotation mark of the subfooting text is omitted, all subsequent lines of the request are treated as part of the subfooting.

By default, FOCUS generates a blank line before a subheading or subfooting. You can eliminate these automatic blank lines by issuing the SET DROPBLNKLIN=ON command. For more information, see the *Developing Applications* manual.

Create a Subhead

```
{ON|BY} fieldname SUBHEAD [NEWPAGE]
"text"
[WHEN expression;]
```

where:

fieldname

Is the sort field before which the text is inserted.

NEWPAGE

Inserts a new page after the sort heading or before the sort footing. Column titles appear on every page. In HTML reports, blank space is added instead of a new page.

text

Is the text you supply between double quotation marks that is printed following the SUBHEAD phrase.

WHEN expression

Specifies a conditional subhead in the printing of a report, as determined by a Boolean expression. Used with SUBHEAD, the WHEN clause must be placed on a line following the text you enclose in double quotation marks.

Using Subheads

This request creates a subheading whenever the PROD_NAME field changes:

```
TABLE FILE PROD
SUM PACKAGE AND UNIT_COST
BY PROD_NAME NOPRINT BY PROD_CODE
ON PROD_NAME SUBHEAD
" SUMMARY FOR <PROD_NAME"
END
```

The output is:

PROD_CODE	PACKAGE	UNIT_COST
-----	-----	-----
SUMMARY FOR AMERICAN CHEESE		
C7	8 OUNCES	\$2.19
SUMMARY FOR BUTTER MILK		
C14	32 OUNCES	\$1.89
SUMMARY FOR CHEDDAR CHEESE		
B19	7 OUNCES	\$.95
SUMMARY FOR CHOCOLATE MILK		
B20	32 OUNCES	\$1.79
SUMMARY FOR HEAVY CREAM		
C17	32 OUNCES	\$1.89
SUMMARY FOR LARGE EGGS		
E2	ONE DOZEN	\$.79
SUMMARY FOR MEDIUM EGGS		
E1	ONE DOZEN	\$.59
SUMMARY FOR SALTED BUTTER		
D15	8 OUNCES	\$.69
SUMMARY FOR SOUR CREAM		
C13	16 OUNCES	\$1.49
SUMMARY FOR SWISS CHEESE		
B17	16 OUNCES	\$1.65
SUMMARY FOR WHIPPED BUTTER		
D12	16 OUNCES	\$1.79
SUMMARY FOR WHOLE MILK		

B10	16 OUNCES	\$.65
B12	32 OUNCES	\$1.15
SUMMARY FOR X-LARGE EGGS		
E3	ONE DOZEN	\$.89

Create Subfoots

The syntax is:

```
{ON|BY} fieldname SUBFOOT [WITHIN] [MULTILINES] [NEWPAGE]
"text"
[WHEN expression;]
```

where:

fieldname

Is the field after which the text is inserted.

WITHIN

Causes the fields in the SUBFOOT to be calculated within each value of **fieldname**. Without this option, a field in the SUBFOOT is taken from the last line of report output above the subfooting.

text

Is the text you supply between double quotation marks that is printed following the SUBFOOT phrase.

MULTILINES

Is used to suppress the SUBFOOT when there is only one line of output for the BY group. Note that MULTI-LINES is a synonym for MULTILINES.

FOCUS also allows you to suppress grand totals using the NOTOTAL phrase as described in [Including Totals and Subtotals](#).

NEWPAGE

Inserts a new page after the heading or before the footing. Column titles appear on every page. In HTML reports, blank space is added instead of a new page.

WHEN expression

Specifies a conditional subfoot in the printing of a report, as determined by a Boolean expression. Used with SUBFOOT, WHEN must be placed on the line following the text you enclose in double quotation marks.

Usage Notes for Creating Subfoots

- When a SUBFOOT follows a RECAP, the default display of the RECAP values is suppressed, as it is assumed that the SUBFOOT is being used to display the RECAP.
- A SUBFOOT can also be used as a complete report request without any display command if data is embedded in the text, because fields in the text become implicit display fields. The default display command is SUM. For more information, see [Using Data in Headings and Footings](#).
- If the report request contains the command SUM and the display field is specified in a subfoot, the value is summed. Use direct operators with fields specified in subfootings.
- SUBFOOT WITHIN is useful where a prefixed field within a sort break would result in a single value (for example, AVE., MIN., MAX). Use of PCT. or APCT. displays only the last value from the sort group.
- SUBFOOT WITHIN "<prefix.fieldname " does not result in the same value as SUBTOTAL prefix. The SUBFOOT WITHIN creates a display field that operates on the original input records. SUBTOTAL with a prefix operates on the internal matrix (so AVE. is the average of the SUMS or, if a display field had the prefix AVE., the average of the averages). SUBFOOT WITHIN "<AVE.field " generates an overall average.
- Prefix operators are not supported on alphanumeric fields in a WITHIN phrase.
- ST. is not supported in a SUBFOOT WITHIN phrase.

Using Subfoots

This example creates a subfooting whenever the DEPARTMENT value changes:

```

TABLE FILE EMPLOYEE
SUM DED_AMT AND GROSS
BY DEPARTMENT BY HIGHEST PAY_DATE
ON DEPARTMENT RECAP
DEPAR_NET/D8.2=GROSS-DED_AMT;
ON DEPARTMENT SUBFOOT
"DEPARTMENT NET = <DEPAR_NET"
END

```

The output is:

DEPARTMENT	PAY_DATE	DED_AMT	GROSS
-----	-----	-----	-----
MIS	82/08/31	\$4,575.72	\$9,000.00
	82/07/30	\$4,117.03	\$7,460.00
	82/06/30	\$4,117.03	\$7,460.00
	82/05/28	\$3,954.35	\$6,649.50
	82/04/30	\$3,386.73	\$5,890.84
	82/03/31	\$1,740.89	\$3,247.75
	82/02/26	\$1,740.89	\$3,247.75
	82/01/29	\$1,740.89	\$3,247.75
	81/12/31	\$1,406.79	\$2,147.75
	81/11/30	\$1,406.79	\$2,147.75
DEPARTMENT NET = 22,311.98			
PRODUCTION	82/08/31	\$4,911.12	\$9,523.84
	82/07/30	\$3,483.88	\$7,048.84
	82/06/30	\$3,483.88	\$7,048.84
	82/05/28	\$3,483.88	\$7,048.84
	82/04/30	\$2,061.69	\$4,959.84
	82/03/31	\$2,061.69	\$4,959.84
	82/02/26	\$2,061.69	\$4,959.84
	82/01/29	\$1,560.09	\$3,705.84
	81/12/31	\$141.66	\$833.33
	81/11/30	\$141.66	\$833.33
DEPARTMENT NET = 27,531.14			

Generating a Subfoot Within a Sort Group

The following request displays the average and minimum salary values first within department, then within department and job class, and last within department, job class and employee ID. Subfootings are generated on the department and jobcode sort fields. The DEFINE FILE command created two additional fields with the SALARY value, one for each sort break:

```

DEFINE FILE EMPDATA
SALDEPT/D6 WITH SALARY = SALARY;
SALDEPTJOB/D6 WITH SALARY = SALARY;
DEPT/A4 WITH SALARY = EDIT(DEPT, '9999');
JOB/A8 WITH SALARY = JOBCLASS;
END
TABLE FILE EMPDATA
SUM AVE.SALDEPT AS 'DEPT,AVE'
MIN.SALDEPT AS 'DEPT,MIN'
BY DEPT
SUM AVE.SALDEPTJOB AS 'DEPT/JOB, AVE' IN 32
MIN.SALDEPTJOB AS 'DEPT/JOB, MIN' IN 42
BY DEPT
BY JOB
PRINT AVE.SALARY/D6 AS 'AVE' IN 52
MIN.SALARY/D6 AS 'MIN' IN 61
BY DEPT
BY JOB
BY PIN NOPRINT
ON DEPT SUBFOOT
"*****DEPARTMENT <DEPT SUBFOOT*****"
"NOT WITHIN: AVE=<AVE.SALARY MIN=<MIN.SALARY "
ON DEPT SUBFOOT WITHIN
" WITHIN: AVE=<AVE.SALARY MIN=<MIN.SALARY "
"*****"
ON JOB SUBFOOT
"</1 *****DEPARTMENT <DEPT / JOB <JOB SUBFOOT*****"
"NOT WITHIN: AVE=<AVE.SALARY MIN=<MIN.SALARY "
ON JOB SUBFOOT WITHIN
" WITHIN: AVE=<AVE.SALARY MIN=<MIN.SALARY "
"*****"
</1"
WHERE DEPT EQ 'MARK'
WHERE JOBCLASS EQ '257PSB' OR '257PTB'
END

```

The report output shows that each SUBFOOT without the WITHIN phrase uses the report line above the subfooting in the calculations. The SUBFOOT within both department and jobcode uses the calculations that were specified in the second SUM command (by department by jobcode), and the SUBFOOT within department only uses the calculations that were specified in the first SUM command (by department):

DEPT	DEPT AVE	DEPT MIN	JOB	DEPT/JOB AVE	DEPT/JOB MIN	AVE	MIN
----	----	----	---	-----	-----	---	---

```

MARK    56,757    50,500    257PSB    55,860    50,500    55,500    55,500
                                                62,500    62,500
                                                50,500    50,500
                                                52,000    52,000
                                                58,800    58,800

```

```

*****DEPARTMENT MARK / JOB 257PSB  SUBFOOT*****
NOT WITHIN: AVE=      $58,800.00  MIN=      $58,800.00
      WITHIN: AVE=      $55,860.00  MIN=      $50,500.00
*****

```

```

                257PTB    59,000    55,500    62,500    62,500
                                                55,500    55,500

```

```

*****DEPARTMENT MARK / JOB 257PTB  SUBFOOT*****
NOT WITHIN: AVE=      $55,500.00  MIN=      $55,500.00
      WITHIN: AVE=      $59,000.00  MIN=      $55,500.00
*****

```

```

*****DEPARTMENT MARK SUBFOOT*****
NOT WITHIN: AVE=      $55,500.00  MIN=      $55,500.00
      WITHIN: AVE=      $56,757.14  MIN=      $50,500.00
*****

```

Creating a Cover Page for Each Sort Group in a Report

The following request prints the subheading "SUM OF PRICES AND QUANTITIES FOR THE region REGION" and then starts a new page containing the data for that region. The PAGE-BREAK command starts a new page after printing this data, prior to the subheading for the subsequent region:

```

TABLE FILE CENTORD
SUM LINEPRICE AS ''
QUANTITY AS ''
BY REGION NOPRINT PAGE-BREAK
BY STATE AS ''
ON REGION SUBHEAD NEWPAGE
"SUM OF PRICES AND QUANTITIES FOR THE <REGION REGION"
END

```

The first few pages of output follow:

PAGE 1

SUM OF PRICES AND QUANTITIES FOR THE EAST REGION

PAGE 2

CT	\$16,238,158.37	65,979
DC	\$70,928,546.26	274,714
DE	\$2,500,849.39	10,226
MA	\$34,010,314.29	131,956
MD	\$24,978,362.10	94,827
NH	\$4,985,236.56	20,752
NJ	\$38,906,712.15	154,974
NY	\$41,667,939.52	171,742
PA	\$27,830,850.54	104,456
RI	\$821,994.05	3,250
VT	\$2,751,969.47	10,631

PAGE 3

SUM OF PRICES AND QUANTITIES FOR THE NORTH REGION

PAGE 4

IA	\$2,469,227.24	10,068
IL	\$34,444,984.60	134,351
IN	\$12,477,236.78	50,124
KS	\$2,136,103.34	7,870
MI	\$47,979,137.95	191,671
MN	\$28,162,612.99	114,687
NA	\$1,027,220.04	3,040
OH	\$25,681,832.51	102,089
ON	\$12,699,111.42	49,142
WI	\$11,283,071.47	44,157

Note that without the PAGE-BREAK command, the subheading for each new region prints at the bottom of the page for the prior region's data.

Using Data in Headings and Footings

You can embed the values of fields in headings, subheads, subfoots, and footings.

Insert Data in Headings and Footings

To put a value in one of these titles, use the following syntax:

```
<fieldname  
<fieldname>
```

where:

<fieldname

Places the data value in the heading or footing, and suppresses trailing blanks.

<fieldname>

Places the data value in the heading or footing, and retains trailing blanks.

Usage Notes for Data in Headings and Footings

- Trailing blanks in alphanumeric fields may be omitted by using only the opening < character for data in headings. For example, if AREA is a 16-character alphanumeric field, the line is expanded by 16 characters at the point of substitution of the retrieved value. If only the opening character is used, only the non-blank characters of the particular value are substituted. For example, if <AREA retrieves the value of EAST, only four characters plus one leading blank are inserted in the line, rather than a full 16 characters which the data value could contain.
- The DST., MDE., and MDN. prefix operators are not supported in headings or footings in requests that have an ACROSS phrase or multiple display commands.
- A SUBFOOT can be used as a complete report request without any display command if data is embedded in the text, because fields in the text become implicit display fields.
- You can place page numbers in headings and footings using TABPAGENO (see [Inserting Page Numbers: TABPAGENO](#)).
- Fields in headings and footings are evaluated as if they were objects of the first verb. Fields in subheads and subfoots are evaluated as part of the first verb in which they are referenced. If a field is not referenced, it is evaluated as part of the last verb.

- Text fields (FORMAT=TXnn) can be embedded in a heading or footing.
 - Text field values may display on multiple lines. The output is aligned vertically so that the position of the field on the initial line is maintained on the following lines.
 - The number of characters in the TX format specification determines the number of spaces per line for the field in the heading or footing.
 - HEADING and FOOTING lines can contain multiple TX fields. SUBHEAD and SUBFOOT lines can contain at most one.
 - You cannot embed TX fields in FML free-text lines.

Using Data in a Heading and Footing

This request displays the DEPARTMENT field in the heading and footing:

```
TABLE FILE EMPLOYEE
"<DEPARTMENT>: BANK, EMPLOYEES AND SALARIES </1"
PRINT CURR_SAL
BY DEPARTMENT NOPRINT BY BANK_ACCT
BY LAST_NAME BY FIRST_NAME
ON DEPARTMENT PAGE-BREAK
FOOTING
"<DEPARTMENT EMPLOYEES WITH ELECTRONIC TRANSFER ACCOUNTS"
END
```

The output is:

```
PAGE      1

MIS      : BANK, EMPLOYEES AND SALARIES

BANK_ACCT  LAST_NAME      FIRST_NAME      CURR_SAL
-----
          GREENSPAN      MARY            $9,000.00
          MCCOY           JOHN            $18,480.00
          SMITH           MARY           $13,200.00
  40950036 JONES            DIANE           $18,480.00
  122850108 BLACKWOOD       ROSEMARIE       $21,780.00
  163800144 CROSS          BARBARA         $27,062.00
```

MIS EMPLOYEES WITH ELECTRONIC TRANSFER ACCOUNTS
PAGE 2

PRODUCTION : BANK, EMPLOYEES AND SALARIES

BANK_ACCT	LAST_NAME	FIRST_NAME	CURR_SAL
-----	-----	-----	-----
	ROMANS	ANTHONY	\$21,120.00
	SMITH	RICHARD	\$9,500.00
	STEVENS	ALFRED	\$11,000.00
160633	BANNING	JOHN	\$29,700.00
136500120	MCKNIGHT	ROGER	\$16,100.00
819000702	IRVING	JOAN	\$26,862.00

PRODUCTION EMPLOYEES WITH ELECTRONIC TRANSFER ACCOUNTS

Positioning Text

The positioning of text and data in headings, footings, subheads, and subfoots can be controlled by a spot marker, which identifies the column where the text should begin. A spot marker consists of a left caret (<) followed by a number indicating the absolute or relative column position. The right caret (>) is optional, and can make the spot marker clearer to a reader.

The various ways spot markers can be used are illustrated in the chart below:

Marker	Example	Usage
<n or <n>	<50	The next character starts in column 50.
<+n or <+n>	<+4	The next character starts four columns from the last non-blank character.
<-n or <-n>	<-1	The next character starts one column to the left of the last character and suppresses or writes over all or part of a field.

Marker	Example	Usage
</n or </n>	</2	Skip two lines.
<0X or <0X>	<0X	Positions the next character immediately to the right of the last character (skip zero columns). This is used when you have more than two lines between the double quotation marks in a stored procedure that make up a single line of heading, subhead, footing, or subfoot display. No spaces are inserted between the spot marker and the start of a continuation line.

i Note: If you place a skip line spot marker on a line by itself, it skips one line more than you asked for. To avoid this, put the skip line marker on the same line with additional text from the report. In addition, each field needs one space for field attributes; if a field placed with a spot marker overlaps an existing field, unpredictable results may occur.

Positioning Text

- To place a character in a specific column:

```
"<50 SUMMARY REPORT"
```

The letter S in SUMMARY starts in Position 50 of the line.

- To place a substituted value in a specific column:

```
"<15 COST OF VEHICLE IS <40 <RCOST>"
"<10 <DIVISION <30 <AREA <50 <DATE"
```

- To add spaces to the right of the last non-blank character:

```
"DAILY REPORT <DATE <+5 <LOCATION <+5 <PRODUCT"
```

- To move to the left of the last non-blank character:

```
"<60 CONFIDENTIAL <-40 <FIRST_NAME"
```

Skipping backward may cover other text on a line. This may be useful in some cases, but in general should be avoided.

- To show four lines of heading text between double quotation marks:

```
"THIS HEADING <0X  
SHOULD APPEAR <0X  
ON ONE <0X  
LINE"
```

The above produces the line:

```
THIS HEADING SHOULD APPEAR ON ONE LINE
```

- To position a long line:

```
"<20 DETAIL REPORT WITH LOTS OF TEXT ON ONE LINE  
<100 EVEN THOUGH IT IS ON TWO LINES IN THE REQUEST"
```

- To skip multiple lines:

```
"</4 THIS IS ON THE FIFTH LINE DOWN"
```

Extending Heading and Footing Code to Multiple Lines

A single line heading or footing code, between double quotation marks, can be a maximum of 32K characters. However, in some editors the maximum length of a line of code in a procedure is 80 characters. In cases like this, you can use the <0X spot marker to continue your heading onto the next line. The heading or footing content and spacing appears exactly as if typed on a single line.

Even if you do not need to extend your code beyond the 80-character line limit, this technique is convenient, since shorter lines may be easier to read on screen and to print on printers.

Extend Heading and Footing Code to Multiple Lines

To extend the length of a single-line heading or footing beyond 80 characters:

Procedure

1. Begin the heading or footing with double quotation marks.
2. Split the heading or footing content into multiple lines of up to 76 characters each, using the <0X spot marker at any point up to the 76th character to continue your heading onto the next line. (The four remaining spaces are required for the spot marker itself, and a blank space preceding it.)
3. Place the closing double quotation marks at the end of the final line of heading or footing code.

Extending Heading and Footing Code to Multiple Lines

This request creates a sort heading coded on two lines. The <0X spot marker positions the first character on the continuation line immediately to the right of the last character on the previous line. No spaces are inserted between the spot marker and the start of a continuation line.

```
SET PAGE-NUM = OFF
JOIN STORE_CODE IN CENTCOMP TO STORE_CODE IN CENTORD
TABLE FILE CENTCOMP
HEADING
"Century Corporation Orders Report"
PRINT PROD_NUM QUANTITY LINEPRICE
BY STORE_CODE NOPRINT
BY ORDER_NUM
ON STORE_CODE SUBHEAD
"Century Corporation orders for store <STORENAME <0X
(store # <STORE_CODE|) <0X in <STATE|."
END
```

The partial output is:

Century Corporation Orders Report

Order	Product	Line	
Number:	Number#:	Quantity:	Total

-----	-----	-----	-----
-------	-------	-------	-------

Century Corporation orders for store Audio Expert (store # 1003CA) in CA.

48108	1006	90	\$29,310.78
	1008	90	\$13,368.96
	1020	90	\$25,033.89
	1032	290	\$20,481.38
	1034	290	\$114,618.37

Century Corporation orders for store Audio Expert (store # 1003CO) in CO.

54095	1006	12	\$3,645.42
	1008	12	\$1,926.35
	1020	12	\$3,314.28
	1032	211	\$15,983.61
	1034	211	\$87,868.51



Tip: Although it is demonstrated here for a sort heading, you can use this technique with any heading or footing line.

Using Data in a Heading

The following example lists the employee's name, department, job description, and skill category in the heading:

```

TABLE FILE EMPLOYEE
"EMPLOYEE NAME           <FIRST_NAME <LAST_NAME"
"CURRENT DEPARTMENT     <DEPARTMENT"
"JOB TITLE              <JOB_DESC"
"*****"
"SKILL CATEGORY         <SKILLS"
"*****"
" "
WHERE EMP_ID IS '112847612'
END

```

The output is:

```

EMPLOYEE NAME           MARY SMITH
CURRENT DEPARTMENT     MIS
JOB TITLE              FILE QUALITY
*****
SKILL CATEGORY         FIQU
*****

```

Using Direct Operators in Headings and Footings

You can use any prefix operator in a heading or footing to perform specific operations. This example prints the maximum, minimum, average, and total units sold:

```

TABLE FILE SALES
"MOST UNITS SOLD WERE   <MAX.UNIT_SOLD"
"LEAST UNITS SOLD WERE <MIN.UNIT_SOLD"
"AVERAGE UNITS SOLD WERE <AVE.UNIT_SOLD"
"TOTAL UNITS SOLD WERE <TOT.UNIT_SOLD"
END

```

The output is:

```

PAGE      1

MOST UNITS SOLD WERE      80
LEAST UNITS SOLD WERE    12
AVERAGE UNITS SOLD WERE  35
TOTAL UNITS SOLD WERE    645

```

This request prints the COUNTRY field, count of models, and average retail cost in a subfoot each time the country changes:

```
TABLE FILE CAR
BY COUNTRY NOPRINT SUBFOOT
"NUMBER OF MODELS IN COUNTRY <COUNTRY = <CNT.MODEL <0X
WITH AVERAGE COST OF <AVE.RCOST "
END
```

The output is:

```
NUMBER OF MODELS IN COUNTRY ENGLAND =      4 WITH AVERAGE COST OF
11,330

NUMBER OF MODELS IN COUNTRY FRANCE =      1 WITH AVERAGE COST OF
5,610

NUMBER OF MODELS IN COUNTRY ITALY =      4 WITH AVERAGE COST OF      12,766

NUMBER OF MODELS IN COUNTRY JAPAN =      2 WITH AVERAGE COST OF      3,239

NUMBER OF MODELS IN COUNTRY W GERMANY =      7 WITH AVERAGE COST OF
9,247
```

This request prints the totals of units sold, returns, and actual sales:

```
DEFINE FILE SALES
ACTUAL_SALES/D8.2 = UNIT_SOLD-RETURNS;
%SALES/F5.1 = 100*ACTUAL_SALES/UNIT_SOLD;
END

TABLE FILE SALES
"SUMMARY OF ACTUAL SALES"
"UNITS SOLD          <TOT.UNIT_SOLD"
"RETURNS            <TOT.RETURNS"
"                   ====="
"TOTAL SOLD         <TOT.ACTUAL_SALES"
" "
"BREAKDOWN BY PRODUCT"
```

```
PRINT UNIT_SOLD AND RETURNS AND ACTUAL_SALES
BY PROD_CODE
END
```

The following shows the beginning of the output:

```
SUMMARY OF ACTUAL SALES
UNITS SOLD          645
RETURNS             58
=====
TOTAL SOLD          587.00

BREAKDOWN BY PRODUCT
PROD_CODE  UNIT_SOLD  RETURNS  ACTUAL_SALES
-----  -
B10                60      10      50.00
                30       2      28.00
                13       1      12.00
B12                40       3      37.00
```

The following special operators are specifically for use in subfootings:

ST.fieldname

Produces a subtotal value of the specified field at a sort break in the report.

CT.fieldname

Produces a cumulative total of the specified field.

Producing a Free-Form Report

Report requests do not have to produce a tabular display, but may consist of only the heading, as long as the heading has a data field referenced in it. If the request has no display command but there is a data field embedded in the heading, FOCUS assumes that this is a heading-only request and does not print the body of the report. Any data fields referenced in the heading are treated as if they were display fields. Their values at the time the heading is printed are what they would have been had they been mentioned as in a display command. Free-form reports are described in detail in [Creating a Free-Form Report](#).

Creating Paging and Numbering

The appearance of your report can be enhanced by controlling paging and page numbering. You can:

- Specify a page break: PAGE-BREAK.
- Insert page numbers: TABPAGENO.
- Specify the number of the first page, and continue page numbering across multiple reports: FOCFIRSTPAGE and FOCNEXTPAGE.
- Suppress page numbers: SET PAGE.
- Prevent an undesirable split: NOSPLIT.

Specifying a Page Break: PAGE-BREAK

Use the PAGE-BREAK option to start a new page each time the specified sort field value changes, or to prevent information that should be grouped together from being presented over more than one page.

To specify a page break, use PAGE-BREAK in either an ON phrase or BY phrase immediately after the sort field on which you want to break the page. Put the PAGE-BREAK command on the lowest-level sort field at which the page break is to occur. You can also use PAGE-BREAK to:

- Reset the report page to 1 at specified points (REPAGE).
- Specify conditional page breaks in the printing of a report (with WHEN).

Specify a Page Break

The syntax is:

```
{ON|BY} fieldname PAGE-BREAK [REPAGE][WHEN expression;]
```

where:

fieldname

Is a sort field. A change in the sort field value causes a page break.

REPAGE

Resets the page number to 1 at the sort break or, if WHEN is used, whenever the conditions in the WHEN clause are met.

WHEN expression

Specifies conditional page breaks in the printing of a report, as determined by a Boolean expression (see [Conditionally Formatting Reports With the WHEN Clause](#)).

Usage Notes for Page Breaks

- Page headings and column titles appear at the top of each new page.
- Page breaks automatically occur whenever a higher-level sort field changes.
- PAGE-BREAK is ignored when report output is stored in HOLD, SAVE, or SAVB files (see [Saving and Reusing Your Report Output](#)).
- When the request has a PAGE-BREAK, the GRANDTOTAL is on a page by itself.

Specifying a Page Break

```
TABLE FILE EMPLOYEE
PRINT EMP_ID
BY SALARY IN-GROUPS-OF 5000
BY PCT_INC BY DAT_INC
ON SALARY PAGE-BREAK
END
```

The first two pages of this report display as:

```
PAGE      1

          SALARY  PCT_INC  DAT_INC  EMP_ID
```



```

      -----
$5,000.00      .00  82/01/04  119265415
                82/04/01  543729165
                .04  82/06/11  543729165
                .05  82/05/14  119265415

PAGE          2

      SALARY  PCT_INC  DAT_INC  EMP_ID
      -----
$10,000.00   .10  82/01/01  071382660
                112847612
                .12  81/01/01  071382660

```

Inserting Page Numbers: TABPAGENO

By default, FOCUS reserves the first two lines of each report page: the first line contains the page number at the left margin—that is, in the top-left corner of the page—and the following line is blank. You can change the position of the page number with the TABPAGENO system variable.

TABPAGENO contains the page number of the current page and acts like a field name. Therefore, it can be positioned in a heading or footing (or subhead/subfoot). The default page number in the top left-hand corner is automatically suppressed when this variable is used.

Note:

- In a styled report, you can also create numbering of the form Page x of y using the TABLASTPAGE variable. For more information, see [Styling Reports](#).
- The variables TABPAGENO and TABLASTPAGE cannot be used to define styling with conditional styling (WHEN).

Inserting Page Numbers

This request

```
TABLE FILE PROD
"<TABPAGENO"
PRINT PACKAGE AND UNIT_COST
BY PROD_NAME BY PROD_CODE
ON PROD_NAME PAGE-BREAK
END
```

creates the following report (of which the first two pages are shown):

```

1
PROD_NAME          PROD_CODE  PACKAGE          UNIT_COST
-----
AMERICAN CHEESE   C7         8 OUNCES         $2.19
2
PROD_NAME          PROD_CODE  PACKAGE          UNIT_COST
-----
BUTTER MILK       C14        32 OUNCES        $1.89
```

Note that FOCUS continues to reserve the top two lines of every report page.

Controlling Report Page Numbering

The SET FOCFIRSTPAGE command enables you to designate the first page number on a report. You can set FOCFIRSTPAGE to a specific number or the value of a Dialogue Manager variable. The &FOCNEXTPAGE variable enables you to establish consecutive page numbering across multiple reports.

When a report is processed, the variable &FOCNEXTPAGE is set to the number following the last page number in the report. This value can then be used as the first page number in a subsequent report, making the report output from multiple requests more useful and readable.

Consecutive page numbering can span multiple -INCLUDE commands.

If TABPAGENO is used in a request with FOCFIRSTPAGE, it correctly reflects the page number set by FOCFIRSTPAGE.

Set the First Page Number for a Report

At the command line, in a FOCEXEC, or in a FOCUS-supported profile:

```
SET FOCFIRSTPAGE = {n|&var}
```

In a TABLE request:

```
ON TABLE SET FOCFIRSTPAGE {n|&var}
```

where:

n

Is the one- to six-digit number to be assigned to the first page of report output. The default value is 1.

&var

Is a Dialogue Manager variable whose value is used as the first page number of the report. &FOCNEXTPAGE is a system variable whose value is one greater than the last page of the prior report.

Setting the Number of the First Page of a Report

This example runs two report requests, each of which uses TABPAGENO in its heading:

- The first report displays a list of movies.
- The second report displays movies with specific ratings. The SET FOCFIRSTPAGE command prior to the second report causes it to start with the next consecutive page number after the end of the first report.

The following procedure contains both report requests:

```
TABLE FILE MOVIES
HEADING
"MOVIES BY CATEGORY AND DIRECTOR:      PAGE <TABPAGENO "
" "
PRINT RATING TITLE
BY CATEGORY BY DIRECTOR
```

```
WHERE CATEGORY EQ 'ACTION' OR 'MUSICALS' OR 'COMEDY' OR 'CHILDREN'
WHERE DIRECTOR NE ' '
WHERE RATING NE 'NR'
END
```

```
-RUN
SET FOCFIRSTPAGE=&FOCNEXTPAGE
```

```
TABLE FILE MOVIES
HEADING
"MOVIES APPROPRIATE FOR CHILDREN:          PAGE <TABPAGENO "
" "
PRINT TITLE
BY CATEGORY BY DIRECTOR BY RATING
WHERE CATEGORY EQ 'ACTION' OR 'MUSICALS' OR 'COMEDY' OR 'CHILDREN'
WHERE DIRECTOR NE ' '
WHERE RATING EQ 'G' OR RATING CONTAINS 'PG'
END
```

The first report has pages 1 and 2. The output is:

```
MOVIES BY CATEGORY AND DIRECTOR:          PAGE          1

CATEGORY  DIRECTOR          RATING  TITLE
-----  -
ACTION    MCDONALD P.      R        RAMBO III
          SCOTT T.         PG       TOP GUN
          SPIELBERG S.    PG       JAWS
          VERHOVEN P.    R        ROBOCOP
          R              TOTAL RECALL
CHILDREN  BARTON C.        G        SHAGGY DOG, THE
          DISNEY W.       G        BAMBI
          GEROMINI        G        ALICE IN WONDERLA
COMEDY    ABRAHAMS J.     PG       AIRPLANE
          ALLEN W.         PG       ANNIE HALL
          BROOKS J.L.    R        BROADCAST NEWS
          HALLSTROM L.   PG13    MY LIFE AS A DOG
          MARSHALL P.    PG       BIG
          ZEMECKIS R.   PG       BACK TO THE FUTUR
MUSICALS ATTENBOROUGH R. PG13    CHORUS LINE, A
          FOSSE B.       PG       CABARET

MOVIES BY CATEGORY AND DIRECTOR:          PAGE          2

CATEGORY  DIRECTOR          RATING  TITLE
-----  -
```

MUSICALS	FOSSE B.	R	ALL THAT JAZZ
	JEWISON N.	G	FIDDLER ON THE ROOF

The second report starts on page 3. The output is:

MOVIES APPROPRIATE FOR CHILDREN:			PAGE	3
CATEGORY	DIRECTOR	RATING	TITLE	
-----	-----	-----	-----	
ACTION	SCOTT T.	PG	TOP GUN	
	SPIELBERG S.	PG	JAWS	
CHILDREN	BARTON C.	G	SHAGGY DOG, THE	
	DISNEY W.	G	BAMBI	
	GEROMINI	G	ALICE IN WONDERLAND	
COMEDY	ABRAHAMS J.	PG	AIRPLANE	
	ALLEN W.	PG	ANNIE HALL	
	HALLSTROM L.	PG13	MY LIFE AS A DOG	
	MARSHALL P.	PG	BIG	
	ZEMECKIS R.	PG	BACK TO THE FUTURE	
MUSICALS	ATTENBOROUGH R.	PG13	CHORUS LINE, A	
	FOSSE B.	PG	CABARET	
	JEWISON N.	G	FIDDLER ON THE ROOF	

Page Number Commands

Command	Description	Applies to
<BYLASTPAGE	Used with REPAGE. Inserts the total page count within the sort group that has the REPAGE option.	HTML PDF PS PPTX
REPAGE	Resets page number to one.	HTML PDF PS PPTX

Command	Description	Applies to
<TABPAGENO	Inserts the current page number. TABPAGENO suppresses the default page number, and the top two lines of a page are blank.	HTML PDF PS PPTX
<TABLASTPAGE	Inserts the total page count in the report.	HTML PDF PS PPTX
SET FOCFIRSTPAGE	Assigns the designated page number to the first page.	HTML PDF PS PPTX
SET PAGE=NUM	Controls page number display.	HTML PDF PS

Suppressing Page Numbers: SET PAGE

Automatic page numbering can also be suppressed with the SET PAGE command.

Suppress Page Numbers

To suppress page numbering, the syntax is:

```
SET PAGE = {OFF|NOPAGE|TOP}
```

where:

OFF

Suppresses automatic page numbering. You can still use the variable TABPAGENO as described in [Inserting Page Numbers: TABPAGENO](#). Note that FOCUS reserves the top two lines of every page.

NOPAGE

Suppresses all page indicators and makes the first two lines of each report page available for your use. NOPAGE does not issue page ejects; they are issued if you use SET PAGE=OFF.

TOP (or NOLEAD)

Omits the line at the top of each page of the report output for the page number and the blank line that follows it. The first line of the report output contains the heading, if one is specified, or the column titles, if there is no heading.

Preventing an Undesirable Split: NOSPLIT

Page breaks sometimes occur where report information has been logically grouped by sort field(s), causing one or two lines to appear by themselves on the next page or screen. To prevent this, use NOSPLIT in either an ON phrase, or immediately after the first reference to the sort field in a BY phrase.

Prevent an Undesirable Split

```
{ON|BY} fieldname NOSPLIT
```

where:

fieldname

Is the name of the sort field for which the sort groups are kept together on the same page.

Whenever the value of the specified field changes, FOCUS determines if the total number of lines related to the new value can fit on the current page. If they cannot, the page breaks and the group of lines appears on the next page.

Usage Notes for Preventing an Undesirable Split

- Only one NOSPLIT option is allowed per report. If a PAGE-BREAK option also exists in the request, it must relate to a higher-level sort field; otherwise, NOSPLIT is ignored.
- Subtotals, footings, subheads, and subfoots are placed on the same page as the detail lines; headings are placed on the new page.
- NOSPLIT is ignored when report output is stored in HOLD, SAVE, or SAVB files (see [Saving and Reusing Your Report Output](#)).
- NOSPLIT is not compatible with the TABLEF command, and produces an FOC037 error message.

Preventing an Undesirable Split

```
TABLE FILE EMPLOYEE
PRINT DED_CODE AND DED_AMT
BY PAY_DATE BY LAST_NAME
ON LAST_NAME NOSPLIT
END
```

Depending upon how many lines your output device is set to, the first two pages of the previous request might display as:

```
PAGE      1

PAY_DATE  LAST_NAME      DED_CODE      DED_AMT
-----  -
81/11/30  CROSS            CITY           $7.52
                        FED           $638.96
```

		FICA	\$526.20
		HLTH	\$32.22
		LIFE	\$19.33
		SAVE	\$77.32
		STAT	\$105.24
	STEVENS	CITY	\$.83
		FED	\$70.83
		FICA	\$58.33
		STAT	\$11.67
PAGE	2		
PAY_DATE	LAST_NAME	DED_CODE	DED_AMT
-----	-----	-----	-----
81/12/31	CROSS	CITY	\$7.52
		FED	\$638.96
		FICA	\$526.20
		HLTH	\$32.22
		LIFE	\$19.33
		SAVE	\$77.32
		STAT	\$105.24
	STEVENS	CITY	\$.83
		FED	\$70.83
		FICA	\$58.33
		STAT	\$11.67

Here are the first two pages without NOSPLIT:

PAGE	1		
PAY_DATE	LAST_NAME	DED_CODE	DED_AMT
-----	-----	-----	-----
81/11/30	CROSS	CITY	\$7.52
		FED	\$638.96
		FICA	\$526.20
		HLTH	\$32.22
		LIFE	\$19.33
		SAVE	\$77.32
		STAT	\$105.24
	STEVENS	CITY	\$.83
		FED	\$70.83
		FICA	\$58.33
		STAT	\$11.67
81/12/31	CROSS	CITY	\$7.52
		FED	\$638.96

		FICA	\$526.20
		HLTH	\$32.22
		LIFE	\$19.33
		SAVE	\$77.32
PAGE	2		
PAY_DATE	LAST_NAME	DED_CODE	DED_AMT
-----	-----	-----	-----
81/12/31	CROSS	STAT	\$105.24
	STEVENS	CITY	\$.83
		FED	\$70.83
		FICA	\$58.33
		STAT	\$11.67
82/01/29	CROSS	CITY	\$7.52
		FED	\$638.96
		FICA	\$526.20
		HLTH	\$32.22
		LIFE	\$19.33
		SAVE	\$77.32
		STAT	\$105.24
	IRVING	CITY	\$6.10
		FED	\$518.92
		FICA	\$427.35
		HLTH	\$50.87
		LIFE	\$30.52

The report without NOSPLIT has an undesirable split for Cross on Page 2, whereas the report using NOSPLIT does not.

Ignoring ON Phrases for Absent Fields

To make report requests flexible, options may be included that are not needed in every situation. User selections then control the options used for each execution of the request.

Options such as subtotals and page breaks are included in a report request using an ON phrase. Some options specified with an ON phrase require a sort field, and others accept a sort or display field. By default, if the field referenced in the ON phrase is not present in the request, or if the option is not supported with the type of field specified, the following message is generated and processing terminates:

```
(FOC013) The 'ON FIELDNAME' FIELD IS NOT A SORT FIELD: sortfield
```

You can use the SET ONFIELD=IGNORE command to instruct FOCUS to ignore ON phrases that reference absent fields or fields that are not supported by the specified option.

Note that any field used must be present in the Master File for the data source or the following message is generated and execution terminates:

```
(FOC003) THE FIELDNAME IS NOT RECOGNIZED: field
```

Control Processing of ON Phrases

```
SET ONFIELD = {ALL|IGNORE}
```

```
ON TABLE SET ONFIELD {ALL|IGNORE}
```

where:

ALL

Issues a message and terminates execution when a field referenced in an ON phrase is not present in the request. ALL is the default value.

IGNORE

Ignores ON phrases that reference fields that are not present in the request, as well as ON phrases that include options not supported by the type of field specified.

Ignoring ON Phrases for Absent Fields

The following request against the EMPDATA data source has ON phrases for the fields DEPT, DIV, and PIN. PIN is a sort field, but the other sort field must be entered at run time as the amper variable &F1:

```
SET USER = EUSER  
TABLE FILE EMPDATA  
  SUM SALARY  
  BY &F1  
  BY PIN
```

```

ON DEPT SKIP-LINE NOSPLIT
ON &F1 SUBTOTAL
ON DIV PAGE-BREAK
ON TABLE SET ONFIELD ALL
END

```

Run the request supplying the value **DEPT** for the variable &F1. The following messages are generated:

```

ERROR AT OR NEAR LINE      8  IN PROCEDURE IGNORE3 FOCEXEC *
(FOC013) THE 'ON FIELDNAME' FIELD IS NOT A SORT FIELD: DIV
BYPASSING TO END OF COMMAND
(FOC009) INCOMPLETE REQUEST STATEMENT

```

Now change the value of the ONFIELD parameter to IGNORE and run the request again, supplying the value **DEPT** for the variable &F1. The partial output is:

DEPT ----	PIN ---	SALARY -----
ACCOUNTING	000000070	\$83,000.00
	000000100	\$32,400.00
	000000300	\$79,000.00
	000000370	\$62,500.00
	000000400	\$26,400.00
*TOTAL ACCOUNTING		\$283,300.00
ADMIN SERVICES	000000170	\$30,800.00
	000000180	\$25,400.00
*TOTAL ADMIN SERVICES		\$56,200.00

Suppressing Fields: SUP-PRINT or NOPRINT

You can create reports that do not display the values or titles of fields, but only use those fields to produce specific effects. FOCUS provides options to suppress the printing of field values: NOPRINT and SUP-PRINT.

Suppress Fields

```
display fieldname {SUP-PRINT|NOPRINT}
{ON|BY} fieldname {SUP-PRINT|NOPRINT}
```

where:

display

Is any display command.

fieldname

Is a sort field or display field. The values of the field may be used, but they are not displayed.

Usage Notes for Suppressing Fields

- If you put a NOPRINT or SUP-PRINT phrase in a computed field, you must then repeat AND COMPUTE before the next computed field.
- If you use the NOPRINT option with a BY field and create a HOLD file, the BY field is excluded from the file. For example, a request that includes the phrase

```
BY DEPARTMENT NOPRINT
```

results in a HOLD file that does not contain the DEPARTMENT field.

Suppressing Fields

To print a list of employee names in alphabetical order, if you simply use the request

```
TABLE FILE EMPLOYEE
PRINT LAST_NAME
END
```

you get a report that lists the last names of employees in the order they were entered into the data source:

```
LAST_NAME
-----
STEVENS
SMITH
JONES
SMITH
BANNING
IRVING
ROMANS
MCCOY
BLACKWOOD
MCKNIGHT
GREENSPAN
CROSS
```

To print the last names in alphabetical order, use NOPRINT in conjunction with a BY phrase:

```
TABLE FILE EMPLOYEE
PRINT LAST_NAME
BY LAST_NAME NOPRINT
END
```

which produces the desired result:

```
LAST_NAME
-----
BANNING
BLACKWOOD
CROSS
GREENSPAN
IRVING
JONES
MCCOY
MCKNIGHT
ROMANS
SMITH
SMITH
STEVENS
```

Suppressing a Sort Field

Consider the following example, where the report is sorted, but the field that determines the sort order is not displayed:

```
TABLE FILE SALES
PRINT UNIT_SOLD AND DELIVER_AMT
BY CITY BY PROD_CODE BY RETAIL_PRICE
ON RETAIL_PRICE SUP-PRINT
END
```

The output is:

CITY	PROD_CODE	UNIT_SOLD	DELIVER_AMT
----	-----	-----	-----
NEW YORK	B10	30	30
	B17	20	40
	B20	15	30
	C17	12	10
	D12	20	30
	E1	30	25
	E3	35	25
NEWARK	B10	13	30
	B12	29	30
STAMFORD	B10	60	80
	B12	40	20
	B17	29	30
	C13	25	30
	C7	45	50
	D12	27	40
	E2	80	100
	E3	70	80
UNIONDALE	B20	25	40
	C7	40	40

Also, consider the following example which does not display a COUNTRY column:

```
TABLE FILE CAR
SUM SALES BY COUNTRY
BY CAR
ON COUNTRY SUB-TOTAL SUP-PRINT PAGE-BREAK
END
```

The first part of the output is:

```

PAGE      1

CAR              SALES
---            -
JAGUAR          12000
JENSEN              0
TRIUMPH           0

*TOTAL ENGLAND
                12000
PAGE      2

CAR              SALES
---            -
PEUGEOT           0

*TOTAL FRANCE
                0
PAGE      3

CAR              SALES
---            -
ALFA ROMEO       30200
MASERATI          0

*TOTAL ITALY
                30200

```

Reducing a Report's Width: FOLD-LINE and OVER

Wide reports are difficult to read, especially on a screen. To reduce a report's width, use FOLD-LINE and OVER.

Compressing the Columns of Reports: FOLD-LINE

A single line on a report can be folded to compress it into fewer columns. This enables you to display a wide report on a narrow screen and enhance the appearance of many reports which might otherwise have wasted space under sort control fields which change infrequently.

Compress Report Columns

```
display fieldname ... FOLD-LINE fieldname ...  
{ON|BY} fieldname FOLD-LINE
```

where:

display

Is any display command.

fieldname

Causes columns to be placed on a separate line when the value of the field changes in the BY or ON phrase. The field name may be a sort field or display field. When it is a display field, it is placed under the preceding field.

Usage Notes for Compressing Report Columns

- The second half of the folded line is offset by two spaces from the first part when the line is folded on a sort control field.
- Instead of FOLD-LINE, you can also use the OVER phrase to decrease the width of reports, as described in [Decreasing the Width of a Report: OVER](#).
- When the point of line folding is after a display field, there is no offset. A simple way to change the line alignment is to use a title with leading blanks. See [Creating New Column Titles: AS](#).

- Up to 16 FOLD-LINE phrases can be used in a request.
- Cell-based styling features including BACKCOLOR and BORDERS are not supported with FOLD-LINE.

Compressing Report Columns

The following report places all fields following the DEPARTMENT field on another line:

```
TABLE FILE EMPLOYEE
SUM ED_HRS BY DEPARTMENT
PRINT ED_HRS AND LAST_NAME AND FIRST_NAME
BY DEPARTMENT BY HIGHEST BANK_ACCT
ON DEPARTMENT FOLD-LINE
END
```

The output is:

```
DEPARTMENT
-----
  ED_HRS  BANK_ACCT  ED_HRS  LAST_NAME  FIRST_NAME
-----  -
MIS
 231.00  163800144  45.00  CROSS     BARBARA
          122850108  75.00  BLACKWOOD ROSEMARIE
          40950036  50.00  JONES   DIANE
                   36.00  SMITH   MARY
                   .00    MCCOY   JOHN
                   25.00  GREENSPAN MARY
PRODUCTION
 120.00  819000702  30.00  IRVING    JOAN
          136500120  50.00  MCKNIGHT ROGER
          160633   .00    BANNING JOHN
                   25.00  STEVENS ALFRED
                   10.00  SMITH   RICHARD
                   5.00   ROMANS  ANTHONY
```

Decreasing the Width of a Report: OVER

One way to decrease the width of your report, particularly when using the ACROSS phrase, is to use OVER. OVER places field names over one another.

Decrease the Width of a Report

```
display fieldname1 OVER fieldname2 OVER fieldname3 ...
```

where:

display

Is any display command.

fieldname1, fieldname2, fieldname3

Are fields to be placed over each other, instead of printed beside each other in a row. The field names must be display fields.

Usage Notes for Decreasing Report Width

Keep the following in mind when using OVER:

- For more complex combinations of IN and OVER, you may want to create subfoots with data. Subfoots with data are discussed in [Using Data in Headings and Footings](#).
- Text fields cannot be specified with OVER.

Decreasing the Width of a Report

The following report stacks the display fields over each other:

```
TABLE FILE EMPLOYEE
SUM GROSS OVER DED_AMT OVER
COMPUTE NET/D8.2M = GROSS - DED_AMT;
ACROSS DEPARTMENT
END
```

The request produces the following report. Notice the ACROSS values display to the left, not directly above the data values.

	DEPARTMENT	
	MIS	PRODUCTION
GROSS	\$50,499.12	\$50,922.38
DED_AMT	\$28,187.25	\$23,391.35
NET	\$22,311.88	\$27,531.03

Without the OVER phrase, the report looks like this:

DEPARTMENT						
MIS			PRODUCTION			
GROSS	\$50,499.12			GROSS	\$50,922.38	
DED_AMT	\$28,187.25	NET	\$22,311.88	DED_AMT	\$23,391.35	NET
	\$27,531.03					

Positioning Columns: IN

FOCUS automatically formats a page and uses common default values for determining column positions and spacing. You can override these defaults by specifying the absolute or relative column position where a data value is to appear on a report.

Position Columns

```
field IN {n|+n}
```

Valid values are:

field

Is the field (that is, the column) that you want to move.

n

Is a number indicating the absolute position of the column.

+n

Is a number indicating the relative position of the column. That is, *+n* is the number of characters to the right of the last column.

Usage Notes for Positioning Columns

- The IN phrase can be used with ACROSS to specify both the starting column of the entire ACROSS set as well as the spacing between each column within the ACROSS.
- When one field is positioned over another (for example, when OVER or FOLD-LINE is used; see [Reducing a Report's Width: FOLD-LINE and OVER](#)), the positions apply to the line on which the referenced field occurs.

Positioning Columns

The following request positions all of the report columns:

```
TABLE FILE EMPLOYEE
PRINT BANK_NAME IN 1
BY HIGHEST BANK_ACCT IN 26
BY LAST_NAME IN 40
END
```

This request produces the following report. There is a blank line following Smith because LAST_NAME is a sort field and there are two employees named SMITH in the database.

BANK_NAME	BANK_ACCT	LAST_NAME
-----	-----	-----
ASSOCIATED	819000702	IRVING
BANK ASSOCIATION	163800144	CROSS
ASSOCIATED	136500120	MCKNIGHT
ASSOCIATED	122850108	BLACKWOOD
STATE	40950036	JONES
BEST BANK	160633	BANNING

```

GREENSPAN
MCCOY
ROMANS
SMITH

STEVENS

```

Positioning Columns With ACROSS

The IN phrase can be used with ACROSS to specify both the starting column of the entire ACROSS set as well as the spacing between each column within the ACROSS, as shown in the following example:

```

TABLE FILE CAR
SUM UNITS IN +1 ACROSS CAR IN 30
BY COUNTRY
END

```

This places one extra space between the data columns in the matrix, and displays the ACROSS sets beginning in Position 30, as shown in the partial first page of the report below.

	CAR		
	ALFA ROMEO	AUDI	BMW
COUNTRY			

ENGLAND	.	.	.
FRANCE	.	.	.
ITALY	30200	.	.
JAPAN	.	.	.
W GERMANY	.	7800	80390

Positioning Columns With FOLD-LINE

When one field is positioned over another (for example, when OVER or FOLD-LINE is used; see [Reducing a Report's Width: FOLD-LINE and OVER](#)), the positions apply to the line on which the referenced field occurs, as in the following example:

```
TABLE FILE CAR
SUM RCOST BY CAR
BY COUNTRY IN 25
ON COUNTRY FOLD-LINE
END
```

which creates this report, in which COUNTRY starts in column 25 and RCOST appears on the second line.

CAR		COUNTRY
---		-----
RETAIL_COST		

ALFA ROMEO		ITALY
19,565		
AUDI		W GERMANY
5,970		
BMW		W GERMANY
58,762		
DATSUN		JAPAN
3,139		
JAGUAR		ENGLAND
22,369		
JENSEN		ENGLAND
17,850		
MASERATI		ITALY
31,500		
PEUGEOT		FRANCE
5,610		

Positioning Columns With OVER

The following report request stacks the SALES field over the RETAIL_COST field:

```
TABLE FILE CAR
PRINT SALES IN 50 OVER RCOST IN 50
BY COUNTRY IN 10 BY MODEL
END
```

The output is:

COUNTRY	MODEL		
-----	-----		
ENGLAND	INTERCEPTOR III	SALES	0
		RETAIL_COST	17,850
	TR7	SALES	0
		RETAIL_COST	5,100
	V12XKE AUTO	SALES	0
		RETAIL_COST	8,878
	XJ12L AUTO	SALES	12000
		RETAIL_COST	13,491
FRANCE	504 4 DOOR	SALES	0
		RETAIL_COST	5,610
ITALY	DORA 2 DOOR	SALES	0
		RETAIL_COST	31,500
	2000 GT VELOCE	SALES	12400
		RETAIL_COST	6,820
	2000 SPIDER VELOCE	SALES	13000
		RETAIL_COST	6,820
	2000 4 DOOR BERLINA	SALES	4800

Separating Sections of a Report: SKIP-LINE and UNDER-LINE

To make a detailed report easier to read and interpret, you can separate sections of it—individual lines, or entire sort groups—by inserting blank lines between them, or (for sort groups only) by underlining them.

Adding Blank Lines: SKIP-LINE

Report information often stands out more clearly if there are lines skipped between individual lines, or between sort groups. You can use SKIP-LINE with either a sort field, or a

display field:

- If you use SKIP-LINE with a sort field, FOCUS inserts a blank line between each section of the report.
- If you use SKIP-LINE with a display field, FOCUS inserts a blank line between each line of the report—in effect, double-spacing the report. Double spacing is especially helpful when a report is used as a review document, as it makes it easy for the reader to write comments next to individual lines.

Add Blank Lines

To add blank lines, use SKIP-LINE with the keyword ON or BY. Use the WHEN clause to specify conditional blank lines in the printing of a report. The syntax is:

```
display fieldname SKIP-LINE  
{ON|BY} fieldname SKIP-LINE [WHEN expression;]
```

where:

display

Is any display command.

fieldname

Is used so that when the value of this field changes, a blank line is inserted before the next set of values.

WHEN expression

Specifies conditional blank lines in the printing of a report as determined by a Boolean expression.

You can use only one SKIP-LINE in each report request. You do not have to enter it on its own line; instead, include it after the field name or sort field for which you want to insert a blank line.

Usage Notes for Adding Blank Lines

Keep the following in mind when using SKIP-LINE:

- If the field name is a sort field, a blank line is inserted just before every change in value of the sort field.
- If the field name is a display field, a blank line is inserted after every printed line. The WHEN clause does not apply to display fields.
- This is one of the only ON conditions that does not have to refer solely to sort control (BY) fields.
- Only one SKIP-LINE option is allowed per request, and it may affect more than one sort field.

Adding Blank Lines

The following example skips a line when the employee ID changes:

```
DEFINE FILE EMPLOYEE
INCREASE/D8.2M = .05*CURRE_SAL;
CURRE_SAL/D8.2M=CURRE_SAL;
NEWSAL/D8.2M=CURRE_SAL + INCREASE;
END

TABLE FILE EMPLOYEE
PRINT CURRE_SAL OVER INCREASE OVER NEWSAL
BY EMP_ID BY LAST_NAME BY FIRST_NAME
ON EMP_ID SKIP-LINE
END
```

The first part of the report output is shown below:

EMP_ID	LAST_NAME	FIRST_NAME		
-----	-----	-----		
071382660	STEVENS	ALFRED	CURRE_SAL	\$11,000.00
			INCREASE	\$550.00
			NEWSAL	\$11,550.00
112847612	SMITH	MARY	CURRE_SAL	\$13,200.00

			INCREASE	\$660.00
			NEWSAL	\$13,860.00
117593129	JONES	DIANE	CURR_SAL	\$18,480.00
			INCREASE	\$924.00
			NEWSAL	\$19,404.00
119265415	SMITH	RICHARD	CURR_SAL	\$9,500.00
			INCREASE	\$475.00
			NEWSAL	\$9,975.00
119329144	BANNING	JOHN	CURR_SAL	\$29,700.00

Underlining Values: UNDER-LINE

Drawing a line across the page after all of the information for a particular section has been displayed can enhance the readability of a printed report.

Underline Values

```
{ON|BY} fieldname UNDER-LINE [WHEN expression;]
```

where:

fieldname

Is used so that a line is drawn when the value of the field changes. A line is automatically drawn after any other option such as RECAP or SUB-TOTAL (but before PAGE-BREAK).

WHEN expression

Specifies conditional underlines in the printing of a report, as determined by a Boolean expression (see [Inserting Page Numbers: TABPAGENO](#)).

Underlining Values

The following example adds an underline when the bank name changes:

```
TABLE FILE EMPLOYEE
PRINT EMP_ID AND BANK_ACCT AND LAST_NAME
BY BANK_NAME
ON BANK_NAME UNDER-LINE
END
```

The request produces the following report:

BANK_NAME	EMP_ID	BANK_ACCT	LAST_NAME
	071382660		STEVENS
	112847612		SMITH
	119265415		SMITH
	126724188		ROMANS
	219984371		MCCOY
	543729165		GREENSPAN
ASSOCIATED	123764317	819000702	IRVING
	326179357	122850108	BLACKWOOD
	451123478	136500120	MCKNIGHT
BANK ASSOCIATION	818692173	163800144	CROSS
BEST BANK	119329144	160633	BANNING
STATE	117593129	40950036	JONES

Controlling Column Title Underlining Using a SET Command

The SET TITLELINE command allows you to control whether column titles are underlined for report output.

With styled output formats, you can also control column title underlining using the TITLELINE StyleSheet attribute. For information, see [Advanced StyleSheet Features](#).

Control Column Title Underlining Using a SET Command

```
SET TITLELINE = (ON|OFF|SKIP)
```

```
ON TABLE SET TITLELINE (ON|OFF|SKIP)
```

where:

ON

Underlines column titles. ON is the default value.

OFF

Replaces the underline with a blank line.

SKIP

Omits both the underline and the line on which the underline would have displayed.

i **Note:** ACROSSLINE is a synonym for TITLELINE.

Controlling Column Title Underlining Using a SET Command

The following request has a BY and an ACROSS field.

```
SET TITLELINE=ON
TABLE FILE GGSales
SUM UNITS BY PRODUCT
ACROSS REGION
ON TABLE SET PAGE-NUM OFF
ON TABLE HOLD FORMAT HTML
ON TABLE SET STYLE *
TYPE=REPORT, GRID=OFF, FONT=ARIAL,$
ENDSTYLE
END
```

With the default value (ON) for SET TITLELINE, the column titles are underlined.

Product	Region			
	Midwest	Northeast	Southeast	West
Biscotti	86105	145242	119594	70436
Capuccino		44785	73264	71168
Coffee Grinder	50393	40977	47083	48081
Coffee Pot	47156	46185	49922	47432
Croissant	139182	137394	156456	197022
Espresso	101154	68127	68030	71675
Latte	231623	222866	209654	213920
Mug	86718	91497	88474	93881
Scone	116127	70732	73779	72776
Thermos	46587	48870	48976	45648

With SET TITLELINE=OFF, the column titles are not underlined, but the blank line where the underlines would have been is still there.

Product	Region			
	Midwest	Northeast	Southeast	West
Biscotti	86105	145242	119594	70436
Capuccino		44785	73264	71168
Coffee Grinder	50393	40977	47083	48081
Coffee Pot	47156	46185	49922	47432
Croissant	139182	137394	156456	197022
Espresso	101154	68127	68030	71675
Latte	231623	222866	209654	213920
Mug	86718	91497	88474	93881
Scone	116127	70732	73779	72776
Thermos	46587	48870	48976	45648

With SET TITLELINE=SKIP, both the underlines and the blank line are removed.

Product	Region			
	Midwest	Northeast	Southeast	West
Biscotti	86105	145242	119594	70436
Capuccino		44785	73264	71168
Coffee Grinder	50393	40977	47083	48081
Coffee Pot	47156	46185	49922	47432
Croissant	139182	137394	156456	197022
Espresso	101154	68127	68030	71675
Latte	231623	222866	209654	213920
Mug	86718	91497	88474	93881
Scone	116127	70732	73779	72776
Thermos	46587	48870	48976	45648

Controlling Column Spacing: SET SPACES

By default, FOCUS puts one or two spaces between report columns, depending on the output width. The SET SPACES command enables you to control the number of spaces between columns in a report.

Control Column Spacing

```
SET SPACES = {n|AUTO}
```

Valid values are:

n

Is a number indicating from 1 to 8 spaces.

AUTO

Specifies that FOCUS automatically puts one or two spaces between columns depending on report output and available output length. AUTO is the default setting.

SET SPACES may also be issued from within a TABLE request.

For ACROSS phrases, SET SPACES *n* controls the distance between ACROSS sets. Within an ACROSS set, the distance between fields is always one space and cannot be changed.

Controlling Column Spacing

The following example illustrates the use of ACROSS with SET SPACES:

```
TABLE FILE CAR
SUM DEALER_COST RETAIL_COST ACROSS CAR BY COUNTRY
IF CAR EQ 'ALFA ROMEO' OR 'BMW'
ON TABLE SET SPACES 8
END
```

The ACROSS set consists of the fields DEALER_COST and RETAIL_COST. The distance between each set is eight spaces.

COUNTRY	CAR		BMW	
	ALFA ROMEO DEALER_COST	RETAIL_COST	DEALER_COST	RETAIL_COST
ITALY	16,235	19,565	.	.
W GERMANY	.	.	49,500	58,762

Creating New Column Titles: AS

Use the AS option to rename existing column titles in your reports. Any of the following titles can be changed with an AS phrase:

- ACROSS titles can be replaced by one line of text only.
- A SUBTOTAL line can be replaced by one line of text only.
- FOR phrases.
- Fields for the MATCH command.

Create Column Titles

The syntax for changing default titles is:

```
field AS 'title1,title2,...'
```

where:

field

Can be a sort field, display field, column total, or row total.

title

Is the new column title enclosed in single quotation marks.

To specify multiple lines in a column title, separate each line's text with commas. Up to five lines are allowed.

Usage Notes for New Column Titles

- When using FOLD-LINE, the titles appear one over the other. No more than one line per title is allowed with FOLD-LINE. (See [Reducing a Report's Width: FOLD-LINE and OVER.](#))
- The use of a title line larger than the format size of the data is one convenient way to space out a report across the columns of the page. For instance,

```
PRINT UNITS BY MONTH AS ' MONTH'
```

shifts the title for MONTH to the right and all other columns, in this case UNITS, shift to the right. For more information on changing the column position, see [Reducing a Report's Width: FOLD-LINE and OVER.](#)

- If you do not want any field name or title displayed in the report, you can also use the AS phrase by entering two consecutive single quotation marks. For example:

```
PRINT LAST_NAME AS ''
```

To display underscores, enclose blanks in single quotation marks.

- If you put an AS phrase in a computed field, you must then repeat the keyword COMPUTE before the next computed field.
- The width allotted for column titles has no limit other than the memory available. It is initially set to 6K, but if that is not enough, the space is dynamically extended to accommodate the column title space required.

Creating New Column Titles

The following example assigns new column titles for the LAST_NAME, FIRST_NAME, and EMP_ID fields:

```
TABLE FILE EMPLOYEE
PRINT FIRST_NAME AS 'NAME' AND LAST_NAME AS ' '
BY DEPARTMENT
BY EMP_ID AS 'EMPLOYEE,NUMBER'
END
```

This request produces the following report:

DEPARTMENT	EMPLOYEE NUMBER	NAME	
-----	-----	----	
MIS	112847612	MARY	SMITH
	117593129	DIANE	JONES
	219984371	JOHN	MCCOY
	326179357	ROSEMARIE	BLACKWOOD
	543729165	MARY	GREENSPAN
	818692173	BARBARA	CROSS
PRODUCTION	071382660	ALFRED	STEVENS
	119265415	RICHARD	SMITH
	119329144	JOHN	BANNING
	123764317	JOAN	IRVING
	126724188	ANTHONY	ROMANS
	451123478	ROGER	MCKNIGHT

Customizing Column Names: SET QUALTITLES

The FOCUS SET command, SET QUALTITLES, enables you to determine whether or not duplicate field names appear as qualified column titles in TABLE output. (For more information about qualified field names, see [Displaying Report Data](#).)

Customize Column Headings

```
SET QUALTITLES = {ON|OFF}
```

where:

ON

Enables qualified column titles when duplicate field names exist and FIELDNAME is set to NEW.

OFF

Disables qualified column titles. OFF is the default value.

SET QUALTITLES may also be issued from within a TABLE request.

Qualified column titles are automatically used, even if qualified field names are not used in the request.

Usage Notes for Qualified Column Titles

- AS names are used if duplicate field names are referenced in a MATCH request.
- AS names are used when duplicate field names exist in a HOLD file.

Column Title Justification

You can specify whether column titles in a report are left-justified, right-justified, or centered. By default, column titles for alphanumeric fields are left-justified, and column

titles for numeric and date fields are right-justified over the displayed column.

Justify Column Titles

The syntax to alter the default justification is:

```
fieldname [alignment] [/format]
```

where:

alignment

Specifies the alignment of the column title.

/R specifies that the column title is to be right-justified.

/L specifies that the column title is to be left-justified.

/C specifies that the column title is to be centered.

/format

Is an optional format specification for the field.

Usage Notes for Justifying Column Titles

- You may specify justification for display fields, BY fields, ACROSS fields, column totals, and row totals. For ACROSS fields, data values, not column titles, are justified as specified.
- For display commands and row totals only, the justification parameter may be combined with a format specification, which precedes or follows the justification parameter (for example, PRINT CAR/A8/R MODEL/C/A15).
- If a title is specified with an AS phrase or in the Master File, that title is justified as specified for the field.
- When multiple ACROSS fields are requested, justification is performed on the lowest ACROSS level only. All other justification parameters for ACROSS fields are ignored.

Justifying Column Titles

The following example illustrates column title justification with a format specification, a BY field specification, and an AS phrase specification:

```
TABLE FILE CAR
PRINT MODEL/A10 STANDARD/A15/R AS 'RJUST,STANDARD' BY CAR/C
WHERE CAR EQ 'JAGUAR' OR 'TOYOTA'
END
```

The output is:

CAR	MODEL	RJUST STANDARD
-----	-----	-----
JAGUAR	V12XKE AUT XJ12L AUTO	POWER STEERING RECLINING BUCKE WHITEWALL RADIA WRAP AROUND BUM 4 WHEEL DISC BR
TOYOTA	COROLLA 4	BODY SIDE MOLDI MACPHERSON STRU

Customizing Reports With SET Parameters

Most SET commands that change system defaults may be issued from within a report request. Many SET command parameters can be used to enhance the readability and usefulness of your reports. The SET command, when used in this manner, affects only the request in which it occurs. For a complete list of SET parameters and acceptable values, see the *Developing Applications* manual.

Use SET Parameters in Requests

The syntax is:

```
ON TABLE SET parameter value [AND parameter value...]
```

where:

parameter

Is the SET command parameter that you wish to change.

value

Replaces the default value.

Setting Parameters in a Report Request

This request changes the NODATA character for missing data from a period (default) to the word NONE. No equal sign is allowed.

```
TABLE FILE EMPLOYEE
PRINT CURR_SAL
BY LAST_NAME BY FIRST_NAME
ACROSS DEPARTMENT
ON TABLE SET NODATA NONE
END
```

This request produces the following report:

LAST_NAME	FIRST_NAME	DEPARTMENT	
		MIS	PRODUCTION
BANNING	JOHN	NONE	\$29,700.00
BLACKWOOD	ROSEMARIE	\$21,780.00	NONE
CROSS	BARBARA	\$27,062.00	NONE
GREENSPAN	MARY	\$9,000.00	NONE
IRVING	JOAN	NONE	\$26,862.00
JONES	DIANE	\$18,480.00	NONE
MCCOY	JOHN	\$18,480.00	NONE
MCKNIGHT	ROGER	NONE	\$16,100.00
ROMANS	ANTHONY	NONE	\$21,120.00
SMITH	MARY	\$13,200.00	NONE
	RICHARD	NONE	\$9,500.00
STEVENS	ALFRED	NONE	\$11,000.00

Conditionally Formatting Reports With the WHEN Clause

Use the WHEN clause in a TABLE request to conditionally display summary lines and formatting options for BY fields. The expression in the WHEN clause enables you to control where options such as SUBTOTAL and SUBFOOT appear in the report.

The WHEN clause is an extension of the ON phrase, and must follow the ON phrase to which it applies. One WHEN clause can be specified for each option in the ON phrase. Multiple WHEN clauses are also permitted.

Used with certain formatting options in a TABLE request, the WHEN clause controls when those formatting options are displayed. If a WHEN clause is not used, the formatting options are displayed whenever the sort field value changes.

Create Conditional Formatting

Syntax for the WHEN clause is:

```
ON fieldname option WHEN expression[;]
```

where:

option

Is any one of the following options for the ON phrase in a TABLE:

RECAP	PAGE-BREAK	SUBHEAD
RECOMPUTE	REPAGE	SUBFOOT
SUBTOTAL	SKIP-LINE	SUB-TOTAL
UNDER-LINE	SUMMARIZE	

If the WHEN clause is used with SUBHEAD or SUBFOOT, it must be placed on the line following the text that is enclosed in double quotation marks (see [Conditionally Formatting Reports With the WHEN Clause](#)).

expression

Is any Boolean expression that is valid on the right side of a COMPUTE expression (see [Using Expressions](#)).

i Note:

- IF ... THEN ... ELSE logic is not necessary in a WHEN clause, and is not supported.
- All non-numeric literals in a WHEN expression must be specified with single quotation marks.
- The semicolon at the end of a WHEN expression is optional, and may be included for readability.

Usage Notes for Conditional Formatting

- A separate WHEN clause may be used for each option specified in an ON phrase. The ON field name phrase needs to be specified only once.
- You can use the WHEN clause to display a different SUBFOOT or SUBHEAD for each break group.
- The WHEN clause only applies to the option that immediately precedes it.
- If a WHEN clause specifies an aggregated field, the value tested is aggregated only within the break determined by the field in the corresponding ON phrase.
- In the WHEN clause for a SUBFOOT, the SUBTOTAL is calculated and evaluated. This applies to fields with prefix operators and to summed fields. For alphanumeric fields, the last value in the break group is used in the test.

Conditionally Formatting Reports

In the following example, the WHEN clause prints a subfoot at the break for the field STORE_CODE only when the sum of PRODSALES exceeds \$500:

```

DEFINE FILE SALES
PRODSALES/D9.2M = UNIT_SOLD * RETAIL_PRICE;
END
TABLE FILE SALES
SUM PRODSALES
BY STORE_CODE
ON STORE_CODE SUBFOOT
"*** SALES FOR STORE <STORE_CODE EXCEED $500 ***"
WHEN PRODSALES GT 500
END

```

The report output looks like this:

```

STORE_CODE      PRODSALES
-----
K1                $56.08
14B               $535.34
*** SALES FOR STORE 14B EXCEED $500 ***
14Z               $224.88
77F               $151.85

```

Selectively Displaying a SUBTOTAL and SUBFOOT

You can print a report that selectively displays a SUBTOTAL and a SUBFOOT with two WHEN phrases:

```

TABLE FILE SALES
PRINT UNIT_SOLD RETAIL_PRICE
BY PROD_CODE
ON PROD_CODE SUBTOTAL
WHEN PROD_CODE CONTAINS 'B'
SUBFOOT
"PLEASE CHECK RECORDS FOR THIS PRODUCT GROUP"
WHEN PROD_CODE CONTAINS 'C'
END

```

The relevant parts of the output are:

```

PROD_CODE  UNIT_SOLD  RETAIL_PRICE
-----
B10                60                $.95

```

	30	\$.85
	13	\$.99
*TOTAL B10	103	\$2.79
B12	40	\$1.29
	29	\$1.49
*TOTAL B12	69	\$2.78
B17	29	\$1.89
	20	\$1.89
*TOTAL B17	49	\$3.78
.		
.		
.		
C13	25	\$1.99
PLEASE CHECK RECORDS FOR THIS PRODUCT GROUP		
C17	12	\$2.09
PLEASE CHECK RECORDS FOR THIS PRODUCT GROUP		
.		
.		
.		

Selectively Displaying Multiple Subheads

In the following example, a different subhead is displayed depending on the value of the BY field. If the value of PROD_CODE contains the literal B, C, or E, the subhead CURRENT PRODUCT LINE is displayed. If PROD_CODE contains the literal D, the subhead DISCONTINUED PRODUCT is displayed.

```
TABLE FILE SALES
PRINT UNIT_SOLD RETAIL_PRICE
BY PROD_CODE
ON PROD_CODE
SUBHEAD
"CURRENT PRODUCT LINE"
```

```

WHEN PROD_CODE CONTAINS 'B' OR 'C' OR 'E'
SUBHEAD
"DISCONTINUED PRODUCT"
WHEN PROD_CODE CONTAINS 'D'
END

```

This produces the following report:

PROD_CODE	UNIT_SOLD	RETAIL_PRICE
-----	-----	-----
CURRENT PRODUCT LINE		
B10	60	\$.95
	30	\$.85
	13	\$.99
CURRENT PRODUCT LINE		
B12	40	\$1.29
	29	\$1.49
CURRENT PRODUCT LINE		
B17	29	\$1.89
	20	\$1.89
CURRENT PRODUCT LINE		
B20	15	\$1.99
	25	\$2.09
CURRENT PRODUCT LINE		
C13	25	\$1.99
CURRENT PRODUCT LINE		
C17	12	\$2.09
CURRENT PRODUCT LINE		
C7	45	\$2.39
	40	\$2.49
DISCONTINUED PRODUCT		
D12	27	\$2.19
	20	\$2.09
CURRENT PRODUCT LINE		
E1	30	\$.89
CURRENT PRODUCT LINE		
E2	80	\$.99
CURRENT PRODUCT LINE		
E3	70	\$1.09
	35	\$1.09

Selectively Displaying a Subfoot

In the following example, a subtotal is calculated for each PROD_CODE, but the subfoot is displayed only when PROD_CODE contains the literal B:

```

SET PAGE-NUM = OFF
SET SCREEN = PAPER
-RUN
TABLE FILE SALES
PRINT UNIT_SOLD RETAIL_PRICE
BY PROD_CODE
ON PROD_CODE SUBTOTAL AND SUBFOOT
"PLEASE CHECK RECORDS FOR THIS PRODUCT GROUP"
" "
WHEN PROD_CODE CONTAINS 'B'
END

```

The partial output is:

PROD_CODE	UNIT_SOLD	RETAIL_PRICE
-----	-----	-----
B10	60	\$.95
	30	\$.85
	13	\$.99
*TOTAL B10	103	\$2.79
PLEASE CHECK RECORDS FOR THIS PRODUCT GROUP		
B12	40	\$1.29
	29	\$1.49
*TOTAL B12	69	\$2.78
PLEASE CHECK RECORDS FOR THIS PRODUCT GROUP		
B17	29	\$1.89
	20	\$1.89
*TOTAL B17	49	\$3.78
PLEASE CHECK RECORDS FOR THIS PRODUCT GROUP		
B20	15	\$1.99

	25	\$2.09
*TOTAL B20		
	40	\$4.08
PLEASE CHECK RECORDS FOR THIS PRODUCT GROUP		
C13	25	\$1.99
*TOTAL C13		
	25	\$1.99
C17	12	\$2.09
*TOTAL C17		
	12	\$2.09

Using Aggregation in the WHEN Clause

The following request prints a subfoot depending on the sum of the UNIT_SOLD field. Each subfoot displays the subtotal of the UNIT_SOLD field within its sort group:

```
TABLE FILE SALES
SUM UNIT_SOLD
  BY STORE_CODE BY PROD_CODE

ON STORE_CODE SUBFOOT
"SELLING ABOVE QUOTA <ST.UNIT_SOLD "
" "
WHEN UNIT_SOLD GT 100
SUBFOOT
"SELLING AT QUOTA <ST.UNIT_SOLD"
" "
WHEN UNIT_SOLD GE 40 AND UNIT_SOLD LT 100
SUBFOOT
"SELLING BELOW QUOTA <ST.UNIT_SOLD"
" "
WHEN UNIT_SOLD LT 40
END
```

The output is:

```
STORE_CODE  PROD_CODE  UNIT_SOLD
-----
```

K1	B10	13
	B12	29
SELLING AT QUOTA	42	
14B	B10	60
	B12	40
	B17	29
	C13	25
	C7	45
	D12	27
	E2	80
	E3	70
SELLING ABOVE QUOTA	376	
14Z	B10	30
	B17	20
	B20	15
	C17	12
	D12	20
	E1	30
14Z	E3	35
SELLING ABOVE QUOTA	162	
77F	B20	25
	C7	40
SELLING AT QUOTA	65	

Controlling the Display of Empty Reports

The SET command, SET EMPTYREPORT, enables you to control the output generated when a TABLE request retrieves zero records.

The EMPTYREPORT=ANSI setting introduces ANSI-compliant handling of reports with zero records, producing a one-line report containing only the specified missing data character. If the request is a COUNT operation, however, a zero is displayed for the missing values.

Control Empty Reports

Use this command:

```
SET EMPTYREPORT = {ANSI|ON|OFF}
```

Valid values are:

ANSI

Produces a single-line report and displays the missing data character or a zero if a COUNT is requested. In each case, &RECORDS will be 0, and &LINES will be 1.

If the SQL Translator is invoked, ANSI automatically replaces OFF as the default setting for EMPTYREPORT.

ON

Generates an empty report when zero records are found.

OFF

Does not generate a report when zero records are found. OFF is the default setting.

The command may also be issued from a request. For example:

```
ON TABLE SET EMPTYREPORT ON
```

Controlling the Display of Empty Reports

following request does not retrieve any records and sets the EMPTYREPORT parameter to OFF.

```
SET EMPTYREPORT=OFF
TABLE FILE WFLITE
HEADING
"This is the heading"
SUM COGS_US REVENUE_US COLUMN-TOTAL ROW-TOTAL
BY COUNTRY_NAME
WHERE COUNTRY_NAME EQ 'Louisiana'
FOOTING
"This is the footing"
ON TABLE SET STYLE *
GRID=OFF,$
END
```

The following output is produced.

```
0 NUMBER OF RECORDS IN TABLE=          0 LINES=          0
```

Changing the EMPTYREPORT setting to ON produces the output shown in the following image.

```
PAGE 1

This is the heading
Customer
Country    Cost of Goods  Revenue  TOTAL
```

Changing the EMPTYREPORT setting to ANSI produces the output shown in the following image.

```
PAGE 1

This is the heading
Customer
Country    Cost of Goods  Revenue  TOTAL
.          .          .          .

TOTAL          .          .          $.00

This is the footing
```

Usage Notes for Displaying Empty Reports

- TABLEF is not supported with SET EMPTYREPORT. When a TABLEF request retrieves zero records, EMPTYREPORT behaves as if EMPTYREPORT is set ON.
- This is a change in default behavior from prior releases of FOCUS. To restore prior default behavior, issue the SET EMPTYREPORT = ON command.
- SET EMPTYREPORT = OFF is not supported for HOLD FORMAT WP files or styled output formats.

- SET EMPTYREPORT = ON behaves as described regardless of ONLINE or OFFLINE settings.

Controlling the Generation of Blank Lines in Report Output

The DROPBLNKLINE parameter controls whether blank lines display in a FOCUS report. With the options provided, you can affect blank lines that are automatically generated in different locations within a report. You can choose to drop the blank lines around subtotals, subheadings and subfootings, as well as certain data lines that may be blank and appear as blank lines on the report output. Additionally, when using borders, you can select to remove blank lines inserted around the headings and footings. You can eliminate these blank lines from the report output using the SET DROPBLNKLINE options.

Control Automatic Blank Lines on Report Output

```
SET DROPBLNKLINE={OFF|ON|BODY|HEADING|ALL}
```

or

```
ON TABLE SET DROPBLNKLINE {OFF|ON|BODY|HEADING|ALL}
```

where:

OFF

Inserts system-generated blank lines as well as empty data lines. OFF is the default value.

ON|BODY

Removes system-generated blank lines within the body of the report, for example, before and after subheads. In addition, certain data lines that may be blank and appear as blank lines on the report output will be removed from the output. BODY is a synonym

for ON.

HEADING

Removes the blank lines between headings and titles and between the report body and the footing. Works in positioned formats (PDF, PS, DHTML, PPT) when a request has a border or bgcolor StyleSheet attribute anywhere in the report.

ALL

Provides both the ON and HEADING behaviors.

Usage Notes for SET DROPBLNKLINE=HEADING

- In the positioned report formats (PDF, PS, DHTML, and PPT) with borders or bgcolor, the system automatically generates a blank line below the heading and above the footing. This is done by design to make bordered lines work together. Generally, the rule is that each line is responsible for the border setting for its top and left border. Therefore, the bottom border of the heading is set by the top border of the row beneath it. To ensure that the bottom of the heading border is complete and does not interfere with the top of the column titles border, a blank filler line is automatically inserted. This filler line contains the defined bottom border of the heading as its top border. The same is true between the bottom of the data and the top of the footing.

DROPBLNKLINE=HEADING removes the filler blank line by defining the height of the filler line to zero. This causes the bottom border of the heading to become the top border of the column titles. When bgcolor is used without borders, this works well to close any blank gaps in color. However, FOCUS processing will not remediate between line styles, so using different border styles between different report elements may create some contention between the border styling definitions. To ensure that you have consistent border line styling between different report elements, use a single line style between the elements that present together in the report.

- DROPBLNKLINE=HEADING is not supported with:
 - Different border styles between the heading and the column titles or the data and the footing.
 - Reports that use the ACROSS sort phrase.

- Non-styled report output including FORMAT WP.
- Usage Considerations:
 - In some reports, FOOTING BOTTOM requires the space added by the system-generated blank line between the data and the footing in order to present the correct distance between the sections. In these instances, the top of the FOOTING BOTTOM may slightly overlap the bottom of the data grid. You can resolve this by adding a blank line to the top of your footing.
 - Applying borders for the entire report (TYPE=REPORT) is recommended to avoid certain known issues that arise when bordering report elements individually. In some reports that define bgcolor and borders on only select elements, the bgcolor applied to the heading displays with a different width than the bgcolor applied to the column titles. This difference causes a ragged right edge to present between the headings and the titles. Additionally, if you define the color of the border (BORDER-COLOR) for elements with bgcolor to match the bgcolor of those elements, the borders will blend into the bgcolor and not be visible.

Comparing DROPBLNKLINE Parameter Settings

The following request against the GGSales data source has a heading, a footing, and a subtotal. Initially, DROPBLNKLINE is set to OFF.

```
TABLE FILE GGSales
HEADING CENTER
"Gotham Grinds Sales By Region"
FOOTING CENTER
"Generated on: &DATETMDYY"
SUM DOLLARS UNITS
BY REGION SUBTOTAL
BY CATEGORY
BY PRODUCT
WHERE REGION EQ 'Northeast' OR 'West'
ON TABLE HOLD FORMAT PDF
ON TABLE SET DROPBLNKLINE OFF
ON TABLE SET PAGE NOPAGE
ON TABLE SET STYLE *
SQUEEZE = ON,
FONT = ARIAL,
TYPE=HEADING, BORDER=LIGHT,
```

```

$
ENDSTYLE
END

```

The output has a blank line below the heading, above the footing, above and below the subtotal lines, and above the grand total line.

Gotham Grinds Sales By Region				
<u>Region</u>	<u>Category</u>	<u>Product</u>	<u>Dollar Sales</u>	<u>Unit Sales</u>
Northeast	Coffee	Capuccino	542095	44785
		Espresso	850107	68127
		Latte	2771815	222866
	Food	Biscotti	1802005	145242
		Croissant	1670818	137394
		Scone	907171	70732
	Gifts	Coffee Grinder	509200	40977
		Coffee Pot	590780	46185
		Mug	1144211	91497
		Thermos	604098	48870
*TOTAL REGION Northeast			11392300	916675
West	Coffee	Capuccino	895495	71168
		Espresso	907617	71675
		Latte	2670405	213920
	Food	Biscotti	863868	70436
		Croissant	2425601	197022
		Scone	912868	72776
	Gifts	Coffee Grinder	603436	48081
		Coffee Pot	613624	47432
		Mug	1188664	93881
		Thermos	571368	45648
*TOTAL REGION West			11652946	932039
TOTAL			23045246	1848714
Generated on: JAN 10, 2012				

Changing the DROPBLNKLINE setting to HEADING produces the following output. The blank line below the heading and the blank line above the footing have been removed. The blank lines above and below the subtotal and grand total lines are still inserted.

Gotham Grinds Sales By Region				
Region	Category	Product	Dollar Sales	Unit Sales
Northeast	Coffee	Capuccino	542095	44785
		Espresso	850107	68127
		Latte	2771815	222866
	Food	Biscotti	1802005	145242
		Croissant	1670818	137394
		Scone	907171	70732
	Gifts	Coffee Grinder	509200	40977
		Coffee Pot	590780	46185
		Mug	1144211	91497
		Thermos	604098	48870
*TOTAL REGION Northeast			11392300	916675
West	Coffee	Capuccino	895495	71168
		Espresso	907617	71675
		Latte	2670405	213920
	Food	Biscotti	863868	70436
		Croissant	2425601	197022
		Scone	912868	72776
	Gifts	Coffee Grinder	603436	48081
		Coffee Pot	613624	47432
		Mug	1188664	93881
		Thermos	571368	45648
*TOTAL REGION West			11652946	932039
TOTAL			23045246	1848714
Generated on: JAN 10, 2012				

Changing the DROPBLNKLINE setting to ON (or BODY) produces the following output in which the blank lines above and below the subtotal and grand total lines have been removed, but the blank lines below the heading and above the footing are still inserted.

Gotham Grinds Sales By Region					
Region	Category	Product	Dollar Sales	Unit Sales	
Northeast	Coffee	Capuccino	542095	44785	
		Espresso	850107	68127	
		Latte	2771815	222866	
	Food	Biscotti	1802005	145242	
		Croissant	1670818	137394	
		Scone	907171	70732	
	Gifts	Coffee Grinder	509200	40977	
		Coffee Pot	590780	46185	
		Mug	1144211	91497	
		Thermos	604098	48870	
	*TOTAL REGION	Northeast		11392300	916675
	West	Coffee	Capuccino	895495	71168
Espresso			907617	71675	
Latte			2670405	213920	
Food		Biscotti	863868	70436	
		Croissant	2425601	197022	
		Scone	912868	72776	
Gifts		Coffee Grinder	603436	48081	
		Coffee Pot	613624	47432	
		Mug	1188664	93881	
		Thermos	571368	45648	
*TOTAL REGION	West		11652946	932039	
TOTAL			23045246	1848714	

Generated on: JAN 10, 2012

Changing the DROPBLNKLINE setting to ALL produces the following output in which the blank lines around the subtotal and grand total lines as well as the blank lines below the heading and above the footing have been removed.

Gotham Grinds Sales By Region				
Region	Category	Product	Dollar Sales	Unit Sales
Northeast	Coffee	Capuccino	542095	44785
		Espresso	850107	68127
		Latte	2771815	222866
	Food	Biscotti	1802005	145242
		Croissant	1670818	137394
		Scone	907171	70732
	Gifts	Coffee Grinder	509200	40977
		Coffee Pot	590780	46185
		Mug	1144211	91497
		Thermos	604098	48870
*TOTAL REGION	Northeast		11392300	916675
West	Coffee	Capuccino	895495	71168
		Espresso	907617	71675
		Latte	2670405	213920
	Food	Biscotti	863868	70436
		Croissant	2425601	197022
		Scone	912868	72776
	Gifts	Coffee Grinder	603436	48081
		Coffee Pot	613624	47432
		Mug	1188664	93881
		Thermos	571368	45648
*TOTAL REGION	West		11652946	932039
TOTAL			23045246	1848714

Generated on: JAN 10, 2012

Saving and Reusing Your Report Output

When you run a report request, by default the data values are collected and presented in a viewable form, complete with column titles and formatting features. Instead of viewing the data values, you can save them to a special data file to:

- Display as a webpage, as a printed document, or in a text document.
- Process in another application, such as a spreadsheet, a database, a word processor, or a 3GL program.
- Send to another location, such as a browser or PC.
- Extract a subset of the original data source in order to generate multi-step reports.
- Extract a data source to a structured extract file that retains information about the segment relationships in order to facilitate migration of data sources and reports between operating environments.

Saving Your Report Output

The following commands extract and save report output in a variety of file formats:

- **HOLD.** The HOLD command creates a data source containing the output of a report request. By default, the data is stored in binary format, but you can specify a different format, such as FOCUS, HTML, or Excel. For some formats, the HOLD command also creates a corresponding Master File. You can then write other report requests that in turn extract or save data from the HOLD file. See [Creating a HOLD File](#).
- **SAVE and SAVB.** The SAVE command is identical to a HOLD command, except that it does not create a Master File, and ALPHA is the default format. If you wish to create a SAVE file in BINARY format, use a variation of the SAVE command called SAVB.

As with a HOLD file, you can specify a variety of formats suitable for use with other software products. See [Creating SAVE and SAVB Files](#).

- **PCHOLD.** The PCHOLD command creates a data source containing the output of a

report request, and downloads the HOLD data source and the optional Master File to a client computer or browser. As with a HOLD file, you can specify a variety of file formats. See [Creating a PCHOLD File](#).

✔ **Tip:** When saving or holding output files, it is recommended to have an Allocation in place for the file. This is not applicable for PCHOLD files.

Naming and Storing Report Output Files

During a session, a report output file remains usable until it is erased or overwritten. A subsequent output file created during the same session replaces the initial version, unless you give it another name by using the AS phrase.

An ALLOCATE command is automatically issued when you create an output file. The ddname used to identify the file is the same as the name of the report output file (HOLD, SAVE, or SAVB, or the name in the AS phrase), if not already allocated.

By default, report output files created with HOLD, SAVE, or SAVB are written to temporary space. When the session ends, these files are no longer available unless you save the output to a specific location.

To save report output files to a specific location, use an ALLOCATE command. You can dynamically allocate an output file using the DYNAM ALLOCATE or TSO ALLOCATE command.

See the *Overview and Operating Environments* manual for details.

When you create a HOLD file using the syntax ON TABLE HOLD AS *name*, the name can contain up to the maximum number of characters supported by your operating system. For more information, see the section *Naming a Master File* in the manual.

Creating a HOLD File

You can use the HOLD command to create report output files for a range of purposes:

- As a tool for data extraction, the HOLD command enables you to retrieve and process data, then extract the results for further processing. Your report request can create a

new data source, complete with a corresponding Master File, from which you can generate new reports.

The output Master File contains only the fields in the report request. The fields in a HOLD file have the original names specified in the Master File that are retrieved if the report is displayed or printed. You can alter the field names in the output Master File using the AS phrase in conjunction with the command SET ASNAMES. See [Controlling Field Names in a HOLD Master File](#).

- The HOLD command enables you to specify the appropriate formats for displaying or processing report output files in other software applications. See [Choosing Output File Formats](#).
- When an application requires a data format that is not among the HOLD options, you can use a subroutine to process each output record as it is written to the HOLD data source.

If your environment supports the SET parameter SAVEMATRIX, you can preserve the internal matrix of your last report in order to keep it available for subsequent HOLD, SAVE, and SAVB commands when the request is followed by Dialogue Manager commands. For details on SAVEMATRIX, see the *Developing Applications* manual.

Create a HOLD File

From a report request, use

```
ON TABLE HOLD [AS filename] [FORMAT fmt] [DATASET dataset]
  [MISSING {ON|OFF}][VIA program]
  [PERSISTENCE {STAGE|PERMANENT}]
```

or

```
hold_field HOLD [AS filename] [FORMAT fmt] [DATASET dataset]
  [MISSING {ON|OFF}][VIA program]
  [PERSISTENCE {STAGE|PERMANENT}]
```

After a report is executed, use

```
HOLD [AS filename] [FORMAT fmt] [DATASET dataset]
      [MISSING {ON|OFF}] [VIA program]
      [PERSISTENCE {STAGE|PERMANENT}]
```

where:

HOLD

Extracts and saves report output. BINARY is the default format used when the HOLD command is issued without an explicit format. The output is saved with an associated Master File.

i Note: Change the default output format to ALPHA by issuing the SET HOLDFORMAT command.

hold_field

Is the name of the last display field in the request.

AS filename

Specifies a name for the HOLD file. If you do not specify a file name, HOLD becomes the default. Since each subsequent HOLD command overwrites the previous HOLD file, it is advisable to code a distinct file name in each request to direct the extracted data to a separate file, thereby preventing it from being overwritten by the next HOLD command.

The name can contain up to the maximum number of characters supported by your operating system. For more information, see the section *Naming a Master File* in the *ibi™ FOCUS® Describing Data* manual.

FORMAT fmt

Specifies the format of the HOLD output file. BINARY is the default format.

- To display as a webpage, choose: HTML, HTMTABLE, DHTML
- To display as a printed document, choose: PDF, PS
- To use in a text document, choose: ALPHA, DOC, WP
- To use in a spreadsheet application, choose: DIF, EXCEL, EXL97, EXL2K [PIVOT], LOTUS, SYLK
- To use in a database application, choose: COMMA, COM, COMT, DATREC, DFIX,

DB2, FOCUS, SQL, SQLORA, SQLDBC, TAB, TABT, XFOCUS

- To use with a 3-GL program, choose: INTERNAL
- To use for additional reporting, choose: ALPHA, BINARY, FOCUS
- To use as a transaction file for modifying a data source, choose: ALPHA, BINARY
- To use for interactive analysis without connection to a FOCUS, choose: AHTML

For details about all available formats, see [Choosing Output File Formats](#).

dataset

Can be a fully qualified data set or file name or an n-part name (app/.../filename.ext).

You can specify a data set or file to contain the report output within the request itself, rather than relying on an external or default specification. This allows you to place a permanent hold file in any folder, directory or data set that you can write to, whether or not that location is included in your APP PATH. The accompanying HOLD Master File will have the DATASET attribute pointing to the file that was generated.

The case in which the data set name is added in the Master File depends on the value of the FILECASE parameter. By default, lowercase is used. The actual data set is created with its name in the case that conforms to the standards of your operating environment.

Note:

- On z/OS, the file cannot already exist or be allocated when the HOLD command is issued. Therefore, if the file already exists you must free the allocation and then delete the file before running the request.
- You can use a USS naming convention for the DATASET attribute to store the file in the USS environment (for text output types).

MISSING

Controls whether fields with the attribute MISSING=ON in the Master File are carried over into the HOLD file. MISSING ON is the default attribute. If the HOLD command specifies MISSING OFF, fields with the MISSING attribute are not carried over. For related information, see [Handling Records With Missing Field Values](#). Also see the *Developing Applications* manual for the SET HOLDMISS, SET NULL, and SET HNODEATA parameters, which control how missing values are propagated to alphanumeric and comma-delimited files.

VIA program

Calls a user-coded program to create the extract file. BINARY is the default format; ALPHA format is also available. Other formats are not available when you use a program with the HOLD command.

PERSISTENCE

Applies only to Relational HOLD files (FORMAT *sqlengine*). Specifies how to create intermediate tables that will be used only during UPLOAD and EBL requests to accelerate performance by keeping all processing on the DBMS server instead of downloading data into a HOLD file. The actual type of the intermediate table will be determined at run time, based on specific DBMS-supported features and the data-populating mechanisms being used. Valid values are:

- **STAGE.** Will create either a Volatile or GLOBAL TEMPORARY table, for a DBMS that supports that functionality. For a DBMS that does not support that functionality, a message will display and the table will not be created.
- **PERMANENT.** Will create a regular SQL table with a uniquely-generated name that will be used in the request and will be available for further use after the request ends, but will be dropped at the end of the session. This is the default value for PERSISTENCE for HOLD FORMAT *sqlengine*.

Create HOLD Files From Hot Screen

From the FOCUS command line or from Hot Screen, use the following after the report is executed

```
HOLD [AS filename][FORMAT fmt][MISSING {ON|OFF}][VIAprogram]
```

where:

fmt

Can be ALPHA, BINARY, DIF, SYLK, WP, INTERNAL, or FOCUS. If you omit the format, the default HOLD format (BINARY) is used.

You can issue HOLD from the Hot Screen command line at any time while a report is displayed and on any page of the report. Regardless of the page from which you issue the command, the entire report is saved, and a data source and Master File are created for that

report (just as when you issue the HOLD command from within a TABLE request, or after exiting Hot Screen).

You can issue multiple HOLD commands for a single TABLE request; however, once you specify the FOCUS format with a HOLD command from Hot Screen, you cannot issue another HOLD command during that Hot Screen session.

Note that you cannot use the SAVE or SAVB commands from Hot Screen. You must include these commands in a report request, or issue them from the FOCUS command level after exiting Hot Screen.

Using DATASET for HOLD

The following request generates the file ggsum.ftm in the application named test1.

```
APP HOLD test1
TABLE FILE GGSALES
SUM UNITS DOLLARS
BY CATEGORY
BY PRODUCT
ON TABLE HOLD AS GGCOMT FORMAT COMT
DATASET test1/ggsum.ftm
END
```

The generated Master File includes the DATASET attribute.

```
FILENAME=GGCOMT , SUFFIX=COMT ,
DATASET=test1/ggsum.ftm (LRECL 80 RECFM V, $
SEGMENT=GGCOMT, SEGTYPE=S2, $
FIELDNAME=CATEGORY, ALIAS=E01, USAGE=A11, ACTUAL=A11, $
FIELDNAME=PRODUCT, ALIAS=E02, USAGE=A16, ACTUAL=A16, $
FIELDNAME=UNITS, ALIAS=E03, USAGE=I08, ACTUAL=A08, $
FIELDNAME=DOLLARS, ALIAS=E04, USAGE=I08, ACTUAL=A08, $
```

The following request generates the data set USER1.GGHOLD.FTM on z/OS.

```
TABLE FILE GGSALES
SUM UNITS DOLLARS
BY CATEGORY
BY PRODUCT
ON TABLE HOLD AS GGCOMT FORMAT COMT
```

```
DATASET user1.gghold.ftm
END
```

The generated Master File includes the DATASET attribute.

```
FILENAME=GGCOMT , SUFFIX=COMT ,
DATASET=user1.gghold.ftm (LRECL 80 RECFM V, $
SEGMENT=GGCOMT, SEGTYPE=S2, $
FIELDNAME=CATEGORY, ALIAS=E01, USAGE=A11, ACTUAL=A11, $
FIELDNAME=PRODUCT, ALIAS=E02, USAGE=A16, ACTUAL=A16, $
FIELDNAME=UNITS, ALIAS=E03, USAGE=I08, ACTUAL=A08, $
FIELDNAME=DOLLARS, ALIAS=E04, USAGE=I08, ACTUAL=A08, $
```

Set the Default HOLD Format

```
SET HOLDFORMAT = {BINARY|ALPHA}
```

or

```
ON TABLE SET HOLDFORMAT {BINARY|ALPHA}
```

where:

BINARY

Sets the default HOLD file format to BINARY.

ALPHA

Sets the default HOLD file format to ALPHA.

Extracting Data to a HOLD File

The following request extracts data from the EMPLOYEE data source and creates a HOLD file.

```
TABLE FILE EMPLOYEE
SUM CURR_SAL AND ED_HRS
```

```

BY DEPARTMENT
LIST CURR_SAL AND ED_HRS AND BANK_ACCT
BY DEPARTMENT
BY LAST_NAME BY FIRST_NAME
ON TABLE HOLD
END

```

The following message appears:

```

NUMBER OF RECORDS IN TABLE= 12 LINES= 12

```

You then see the message:

```

HOLDING...

```

To display the report generated by this request, either issue a report request against the HOLD file or issue the RETYPE command.



Tip: If you wish to view the information in the HOLD Master File before reporting against it, you can issue the query command ? HOLD.

Query a HOLD Master File

If the HOLD format option you select creates a Master File, you can issue the following command to display the fields, aliases, and formats in the HOLD Master File:

```

? HOLD

```

This command shows field names up to 32 characters. If a field name exceeds 32 characters, a caret (>) in the 32nd position indicates a longer field name.

If you have renamed the HOLD file using AS *filename*, use the following syntax:

```

? HOLD filename

```

✔ **Tip:** You must issue the ? HOLD query in the same session in which the HOLD file is created.

Reporting Against a HOLD Master File

In the following HOLD file, the formats shown are the values of the FORMAT attribute. You can see the values of the ACTUAL attribute by displaying the HOLD Master File using TED or any text editor. USAGE and ACTUAL formats for text fields specify only the length of the first line of each logical record in the HOLD file. The USAGE format is the same as the field format in the original Master File. The ACTUAL format is rounded up to a full (internal) word boundary, as is done for alphanumeric fields.

The following request contains the query command ? HOLD, which displays the fields, aliases, and formats in the associated Master File and creates a HOLD file.

```
TABLE FILE EMPLOYEE
SUM CURR_SAL AND ED_HRS
BY DEPARTMENT
LIST CURR_SAL AND ED_HRS AND BANK_ACCT
BY DEPARTMENT
BY LAST_NAME BY FIRST_NAME
ON TABLE HOLD
END

? HOLD
```

The output is:

NUMBER OF RECORDS IN TABLE=	12	LINES=	12
DEFINITION OF HOLD FILE: HOLD			

FIELDNAME			ALIAS	FORMAT
DEPARTMENT			E01	A10
CURR_SAL			E02	D12.2M
ED_HRS			E03	F6.2
LAST_NAME			E04	A15
FIRST_NAME			E05	A10
LIST			E06	I5
CURR_SAL			E07	D12.2M
ED_HRS			E08	F6.2
BANK_ACCT			E09	I9S

You can now issue the following report request against the HOLD file:

```
TABLE FILE HOLD
PRINT E07 AS 'SALARY OF,EMPLOYEE' AND LAST_NAME AND FIRST_NAME
BY HIGHEST E03 AS 'TOTAL,DEPT,ED_HRS'
```

```

BY E01
BY HIGHEST E08 AS 'EMPLOYEE,ED_HRS'
END

```

The output is:

TOTAL					
DEPT		EMPLOYEE	SALARY OF		
ED_HRS	DEPARTMENT	ED_HRS	EMPLOYEE	LAST_NAME	FIRST_
-----	-----	-----	-----	-----	-----
231.00	MIS	75.00	\$21,780.00	BLACKWOOD	
	ROSEMARIE	50.00	\$18,480.00	JONES	DIANE
		45.00	\$27,062.00	CROSS	BARBARA
		36.00	\$13,200.00	SMITH	MARY
		25.00	\$9,000.00	GREENSPAN	MARY
		.00	\$18,480.00	MCCOY	JOHN
120.00	PRODUCTION	50.00	\$16,100.00	MCKNIGHT	ROGER
		30.00	\$26,862.00	IRVING	JOAN
		25.00	\$11,000.00	STEVENS	ALFRED
		10.00	\$9,500.00	SMITH	RICHARD
		5.00	\$21,120.00	ROMANS	ANTHONY
		.00	\$29,700.00	BANNING	JOHN

Holding Report Output in ibi FOCUS Format

Whether issued within a request or after the request has been executed, the HOLD command can create a FOCUS data source and a corresponding Master File from the data extracted by the report request. This feature enables you to create:

- A FOCUS data source from any other supported data source type.
- A subset of an existing FOCUS data source.

✔ **Tip:** If you are working in an environment that supports SCAN, FSCAN, MODIFY, or Maintain, and you create a HOLD file in FOCUS format, you can update, as well as report against, the HOLD file. See your documentation on these facilities for details.

Create HOLD Files in ibi FOCUS Format

In a report request, use

```
ON TABLE HOLD [AS filename] FORMAT FOCUS [INDEX field1 field2 ...]
```

After a report request is run, use

```
HOLD [AS filename] FORMAT FOCUS [INDEX field1field2...]
```

where:

AS filename

Specifies a name for the HOLD file. If you do not specify a file name, HOLD becomes the default. Since each subsequent HOLD command overwrites the previous HOLD file, it is advisable to provide a distinct file name in each request to direct the extracted data to a separate file, thereby preventing it from being overwritten by the next HOLD command.

The name can be up to 64 characters long.

i Note: If you use a name longer than eight characters on z/OS, an eight-character member name is generated as described in the *ibi™ FOCUS® Describing Data* manual. To relate the long name to the short member name, the \$ VIRT attribute is generated on the top line in the Master File. The resulting HOLD file is a temporary data file. To allocate the long Master File name to a permanent data file, issue the DYNAM ALLOCATE command with the LONGNAME option prior to the HOLD request. The ddname in the command must refer to an existing member of the MASTER data set.

INDEX field1...

Enables you to index FOCUS fields. All fields specified after INDEX are specified as FIELDTYPE=I in the Master File. Up to four fields can be indexed.

i Note: Since the number of index field names is variable, a command name that follows the HOLD command and starts with the same characters as a field name may be counted as another index field, generating an error. For example, if the command following HOLD starts with ON TABLE and a field name starts with the characters 'ON', the ON in the command will be considered a truncated field name to add to the index. To avoid this issue, either set the FIELDNAME parameter to NOTRUNC, so that command names will not be confused with truncated field names, or move the HOLD command to the end of the procedure right before the END command.

Note that once you use this format from Hot Screen, you cannot issue another HOLD command while in the same Hot Screen session.

Operating System Notes for HOLD Files in ibi FOCUS Format

The HOLD file is dynamically allocated if it is not currently allocated. This means the system may delete the file at the end of the session, even if you have not done so. Since HOLD files are usually deleted, this is the desired default. However, if you want to save the Master File, allocate it to ddname HOLDMAST as a permanent data set. The allocation can be performed in the standard FOCUS CLIST. For example:

```
ALLOC F(HOLDMAST) DA('qualif.HOLDMAST') SHR REUSE
```

Note that ddname HOLDMAST must not refer to the same data set referred to by the MASTER and FOCEXEC ddnames.

Controlling the ibi FOCUS File Structure

The structure of the FOCUS data source varies according to the report request. The rules are as follows:

- Each aggregation command (SUM, COUNT, WRITE) creates a segment, with each new BY field in the request becoming a key. In a request that uses multiple display commands, the key to any newly created segment does not contain keys that are in the parent segment.
- If a PRINT or LIST command is used to create a segment, all the BY fields, together with the internal FOCLIST field, form the key.
- All fields specified after INDEX are indexed; that is, FIELDTYPE=I is specified in the Master File. Up to four fields may be indexed.
- If the data in the HOLD file is longer than a page (4K for FOCUS data sources or 16K for XFOCUS data sources), it cannot be stored in a single segment. Data that is too long to become a single segment will become a parent segment with unique child segments. For a FOCUS data source, the fields will be grouped into normal FOCUS page size segments and added as unique segments up to the total maximum of 32K of data. For an XFOCUS data source, the root segment can hold the first 16K of data, and additional data up to the 32K total, will be placed in a single unique segment. BY fields must all occur in the portion of the data assigned to the root segment.

To control whether the ACCEPT and TITLE attributes are propagated to the Master File associated with the HOLD file, use the SET HOLDATTR command. To control the FIELDNAME attribute in the Master File of the HOLD file, use the SET ASNAMES command. For more information on how to control the TITLE, ACCEPT, and FIELDNAME attributes in a HOLD Master File, see [Controlling Attributes in HOLD Master Files](#).

Creating a HOLD File in ibi FOCUS Format

The following example creates a subset of the CAR data source.

```
TABLE FILE CAR
SUM SALES BY COUNTRY BY CAR BY MODEL
ON TABLE HOLD AS X1 FORMAT FOCUS
END
```

This request creates a single-segment FOCUS data source with a SEGTYPE of S3 (because it has three BY fields) named X1.

The X1 Master File is created by the request:

```
FILE=X1, SUFFIX=FOC
SEGMENT=SEG01 ,SEGTYPE=S03
FIELDNAME=COUNTRY      ,ALIAS=E01      ,USAGE=A10      ,$
FIELDNAME=CAR          ,ALIAS=E02      ,USAGE=A16      ,$
FIELDNAME=MODEL        ,ALIAS=E03      ,USAGE=A24      ,$
FIELDNAME=SALES        ,ALIAS=E04      ,USAGE=I6       ,$
```

Using PRINT to Create a ibi FOCUS Data Source With a FOCLIST Field

This example creates a single-segment FOCUS data source with a SEGTYPE of S4 because of the three BY fields and the FOCLIST FIELD.

```
TABLE FILE CAR
PRINT SALES BY COUNTRY BY CAR BY MODEL
ON TABLE HOLD AS X2 FORMAT FOCUS INDEX MODEL
END
```

The Master File created by this request is:

```
FILE=X2, SUFFIX=FOC
SEGMENT=SEG01, SEGTYPE=S04
FIELDNAME=COUNTRY      ,ALIAS=E01      ,USAGE=A10      ,$
FIELDNAME=CAR          ,ALIAS=E02      ,USAGE=A16      ,$
FIELDNAME=MODEL        ,ALIAS=E03      ,USAGE=A24      ,FIELDTYPE=I,$
FIELDNAME=FOCLIST      ,ALIAS=E04      ,USAGE=I5       ,$
FIELDNAME=SALES        ,ALIAS=E05      ,USAGE=I6       ,$
```

Creating a Two-Segment ibi FOCUS Data Source

The following request contains two SUM commands. The first, SUM SALES BY COUNTRY, creates a segment with COUNTRY as the key and the summed values of SALES as a data field. The second, SUM SALES BY COUNTRY BY CAR BY MODEL, creates a descendant segment, with CAR and MODEL as the keys and SALES as a non-key field.

The COUNTRY field does not form part of the key to the second segment. COUNTRY is a key in the path to the second segment. Any repetition of this value is redundant.

```
TABLE FILE CAR
SUM SALES BY COUNTRY
SUM SALES BY COUNTRY BY CAR BY MODEL
ON TABLE HOLD AS X3 FORMAT FOCUS
END
```

This creates a two-segment FOCUS data source:

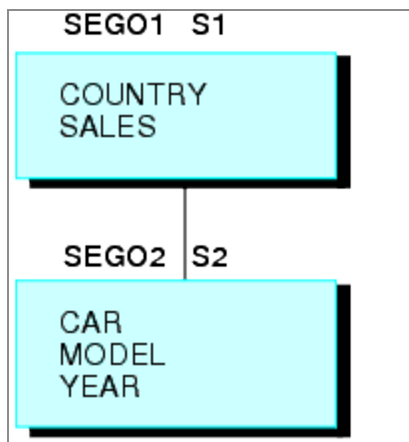

The Master File for this newly-created FOCUS data source is:

```
FILE=X3, SUFFIX=FOC
SEGMENT=SEG01, SEGTYPE=S01
  FIELDNAME=COUNTRY      ,ALIAS=E01      ,USAGE=A10      , $
  FIELDNAME=SALES       ,ALIAS=E02      ,USAGE=I6       , $
SEGMENT=SEG02, SEGTYPE=S02, PARENT=SEG01
  FIELDNAME=CAR         ,ALIAS=E03      ,USAGE=A16      , $
  FIELDNAME=MODEL      ,ALIAS=E04      ,USAGE=A24      , $
  FIELDNAME=SALES      ,ALIAS=E05      ,USAGE=I6       , $
```

Creating a Three-Segment ibi FOCUS Data Source

In this example, each display command creates one segment.

The key to the root segment is the BY field, COUNTRY, while the keys to the descendant segments are the new BY fields. The last segment uses the internal FOCLIST field as part of the key, since the display command is PRINT.

```
TABLE FILE CAR
SUM SALES BY COUNTRY BY CAR
SUM SALES BY COUNTRY BY CAR BY MODEL
PRINT SALES BY COUNTRY BY CAR BY MODEL BY BODY
ON TABLE HOLD AS X4 FORMAT FOCUS INDEX COUNTRY MODEL
END
```

The Master File is:

```
FILE=X4, SUFFIX=FOC
SEGMENT=SEG01, SEGTYPE =S02
  FIELDNAME=COUNTRY    ,ALIAS=E01      ,USAGE=A10    ,FIELDTYPE=I,$
  FIELDNAME=CAR        ,ALIAS=E02      ,USAGE=A16    ,,$
  FIELDNAME=SALES      ,ALIAS=E03      ,USAGE=I6     ,,$
SEGMENT=SEG02, SEGTYPE =S01 ,PARENT=SEG01
  FIELDNAME=MODEL     ,ALIAS=E04      ,USAGE=A24    ,FIELDTYPE=I,$
  FIELDNAME=SALES     ,ALIAS=E05      ,USAGE=I6     ,,$
SEGMENT=SEG03, SEGTYPE =S02 ,PARENT=SEG02
  FIELDNAME=BODYTYPE  ,ALIAS=E06      ,USAGE=A12    ,,$
  FIELDNAME=FOCLIST   ,ALIAS=E07      ,USAGE=I5     ,,$
  FIELDNAME=SALES     ,ALIAS=E08      ,USAGE=I6     ,,$
```

Controlling Attributes in HOLD Master Files

The commands SET ASNAMES, SET HOLDLIST, and SET HOLDATTR enable you to control the FIELDNAME, TITLE, and ACCEPT attributes in HOLD Master Files. These commands are issued prior to the report request and remain in effect for the duration of the session, unless you change them.

- The SET ASNAMES command designates text specified in an AS phrase as the field name in the HOLD Master File, and concatenates it to the beginning of the first field name specified in an ACROSS phrase. See [Controlling Field Names in a HOLD Master](#)

File.

- The SET HOLDLIST command restricts fields in HOLD files to those appearing in a request. That is, non-displaying fields in a request (those designated as NOPRINT fields) are not included in the HOLD file. You can also distinguish between implicitly and explicitly non-displaying fields. See [Controlling Fields in a HOLD Master File](#).
- The SET HOLDATTR command propagates TITLE and ACCEPT attributes used in the original Master File to the HOLD Master File. See [Controlling the TITLE and ACCEPT Attributes in the HOLD Master File](#).

In addition, the SET HOLDSTAT command enables you to include comments and DBA information in the HOLD Master File. For more information about SET HOLDSTAT, see the *ibi™ FOCUS® Describing Data* manual. For details about SET commands, see the *ibi™ FOCUS® Developing Applications* manual.

Controlling Field Names in a HOLD Master File

When SET ASNAMES is set to ON, MIXED or FOCUS, the literal specified in an AS phrase in a report request is used as the field name in a HOLD Master File. This command also controls how ACROSS fields are named in HOLD files.

Control Field Names in a HOLD Master File

```
SET ASNAMES = [ON|OFF|MIXED|FOCUS|FLIP]
```

where:

OFF

Does not use the literal specified in an AS phrase as a field name in HOLD files, and does not affect the way ACROSS fields are named.

ON

Uppercases the literal specified in an AS phrase and propagates it as the field name in the HOLD Master File. Creates names for ACROSS fields that consist of the AS name value concatenated to the beginning of the ACROSS field value and controls the way ACROSS fields are named in HOLD files of any format.

MIXED

Uses the literal specified in an AS phrase for the field name, retaining the case of the AS name, and creates names for ACROSS fields that consist of the AS name value concatenated to the beginning of the ACROSS field value.

FOCUS

Uses the literal specified in an AS phrase as the field name and controls the way ACROSS fields are named only in HOLD files in FOCUS format. FOCUS is the default value.

FLIP

Propagates the field names in the original Master File to the alias names in the HOLD Master File and the alias names in the original Master File to the field names in the HOLD Master File.

Usage Notes for Controlling Field Names in HOLD Files

- If no AS phrase is specified for a field, the field name from the original Master File is used. The TITLE attribute specified in the Master File is not used unless SET HOLDATTRS was previously issued.
- To ensure that fields referenced more than once in a request have unique names in the HOLD Master File, use SET ASNAMES.
- Special characters and blanks used in the AS phrase are preserved in the field name that is created when SET ASNAMES is used. Use single quotation marks around the non-standard field names when referring to them in the newly created Master File.
- Text specified in an AS phrase that contains more than 66 characters is truncated to 66 characters in the Master File.
- When generating field names and aliases for a HOLD file with the default setting for the ASNAMES parameter, if the HOLD file is a relational data source, the field names and aliases from the original Master File are propagated to the HOLD Master File. The alias names become the column names in the generated relational table. The AS name also becomes the TITLE attribute in the HOLD Master File.

When you set the ASNAMES parameter to FLIP, for relational HOLD files, the field names from the original Master File or the AS names specified in the request become the alias names in the HOLD Master File as well as the column names in the generated relational table and the TITLE attributes in the HOLD Master File. The alias names in the original Master File become the field names in the HOLD Master File, except when there is an AS name, in which case the original field name becomes the HOLD field name.

- If the HOLD file is not relational, field names from the original Master File are propagated to the HOLD Master File, but alias names are not propagated, and default aliases of the form E01, E02, and so on, are generated in the HOLD Master File.
- For SET ASNAMES=FLIP, for non-relational HOLD files, the field names from the original Master File or the AS names from the request become the alias names in the HOLD Master File, and default field names are generated in the form F01, F02, and so on.
- Duplicate field names may occur in the newly created Master File as a result of truncation or the way AS phrases have been specified. In this case, refer to the fields by their aliases (E01, E02, and so forth).
- When commas are used as delimiters to break lines in the column heading, only the literal up to the first comma is used as the field name in the Master File. For example, the following produces the field name PLACE in the HOLD Master File:

```
PRINT COUNTRY AS 'PLACE,OF,ORIGIN'
```

- When ACROSS is used in a report request and the results are extracted to a HOLD file, the columns generated by the ACROSS phrase all have the same field name in the HOLD Master File. If SET ASNAMES is issued, each new column may have a unique field name. This unique field name consists of the ASNAME value specified in the request's display command, concatenated to the beginning of the value of the field used in the ACROSS phrase. If several field names have the same letters, this approach does not work.

If an AS phrase is used for the fields in the ACROSS phrase, each new column has a field name composed of the literal in the AS phrase concatenated to the beginning of the value of the first field used in the ACROSS phrase.

- SCAN and FSCAN do not support mixed-case field names.

Controlling Field Names in the HOLD Master File

In the following example, SET ASNAMES=ON causes the text in the AS phrase to be used as field names in the HOLD1 Master File. The two fields in the HOLD1 Master File, NATION and AUTOMOBILE, contain the data for COUNTRY and CAR.

```
SET ASNAMES=ON
TABLE FILE CAR
PRINT CAR AS 'AUTOMOBILE'
BY COUNTRY AS 'NATION'
ON TABLE HOLD AS HOLD1
END
```

The request produces the following Master File:

```
FILE=HOLD1, SUFFIX=FIX
SEGMENT=HOLD1, SEGTYPE=S01,$
FIELDNAME=NATION      ,ALIAS=E01   ,USAGE=A10  ,ACTUAL=A12   , $
FIELDNAME=AUTOMOBILE ,ALIAS=E02   ,USAGE=A16  ,ACTUAL=A16   , $
```

Providing Unique Field Names With SET ASNAMES

The following request generates a HOLD Master File with one unique field name for SALES and one for AVE.SALES. Both SALES and AVE.SALES would be named SALES, if SET ASNAMES had not been used.

```
SET ASNAMES=ON
TABLE FILE CAR
SUM SALES AND AVE.SALES AS 'AVERAGESALES'
BY CAR
ON TABLE HOLD AS HOLD2
END
```

The request produces the following Master File:

```
FILE=HOLD2, SUFFIX=FIX
SEGMENT=HOLD2, SEGTYPE=S01,$
FIELDNAME=CAR          ,ALIAS=E01   ,USAGE=A16  ,ACTUAL=A16   , $
FIELDNAME=SALES       ,ALIAS=E02   ,USAGE=I6   ,ACTUAL=I04   , $
FIELDNAME=AVERAGESALES,ALIAS=E03   ,USAGE=I6   ,ACTUAL=I04   , $
```

Using SET ASNAMES With the ACROSS Phrase

The following request produces a HOLD Master File with the literal CASH concatenated to each value of COUNTRY.

```
SET ASNAMES=ON
TABLE FILE CAR
SUM SALES AS 'CASH'
ACROSS COUNTRY
ON TABLE HOLD AS HOLD3
END
```

The request produces the following Master File:

```
FILE=HOLD3, SUFFIX=FIX
SEGMENT=HOLD3, SEGTYPE=S01,$
FIELDNAME=CASHENGLAND      ,ALIAS=E01      ,USAGE=I6      ,ACTUAL=I04    ,$
FIELDNAME=CASHFRANCE       ,ALIAS=E02      ,USAGE=I6      ,ACTUAL=I04    ,$
FIELDNAME=CASHITALY        ,ALIAS=E03      ,USAGE=I6      ,ACTUAL=I04    ,$
FIELDNAME=CASHJAPAN        ,ALIAS=E04      ,USAGE=I6      ,ACTUAL=I04    ,$
FIELDNAME=CASHW GERMANY    ,ALIAS=E05      ,USAGE=I6      ,ACTUAL=I04    ,$
```

Without the SET ASNAMES command, every field in the HOLD FILE is named COUNTRY.

To generate field names for ACROSS values that include only the field value, use the AS phrase followed by two single quotation marks, as follows:

```
SET ASNAMES=ON
TABLE FILE CAR
SUM SALES AS ''
ACROSS COUNTRY
ON TABLE HOLD AS HOLD4
END
```

The resulting Master File looks like this:

```
FILE=HOLD4, SUFFIX=FIX
SEGMENT=HOLD4, SEGTYPE=S0,$
FIELDNAME=ENGLAND         ,ALIAS=E01      ,USAGE=I6      ,ACTUAL=I04    ,$
FIELDNAME=FRANCE          ,ALIAS=E02      ,USAGE=I6      ,ACTUALI04     ,$
FIELDNAME=ITALY           ,ALIAS=E03      ,USAGE=I6      ,ACTUALI04     ,$
```

```
FIELDNAME=JAPAN      ,ALIAS=E04    ,USAGE=I6  ,ACTUALI04    ,,$
FIELDNAME=W GERMANY ,ALIAS=E05    ,USAGE=I6  ,ACTUALI04    ,,$
```

Generating a HOLD File With SET ASNAMES=FLIP

The following request generates a HOLD file in ALPHA format using the OFF value for SET ASNAMES. The field CURR_SAL has the AS name SALARY in the request:

```
SET ASNAMES=OFF
TABLE FILE EMPLOYEE
SUM CURR_SAL AS SALARY PCT_INC
BY DEPARTMENT
ON TABLE HOLD FORMAT ALPHA
END
```

In the HOLD Master File, AS names have not been propagated, the field names are from the original Master File, and default alias names are generated:

```
FILENAME=HOLD      , SUFFIX=FIX      , IOTYPE=STREAM, $
SEGMENT=HOLD, SEGTYPE=S1, $
  FIELDNAME=DEPARTMENT, ALIAS=E01, USAGE=A10, ACTUAL=A10, $
  FIELDNAME=CURR_SAL, ALIAS=E02, USAGE=D12.2M, ACTUAL=A12, $
  FIELDNAME=PCT_INC, ALIAS=E03, USAGE=F6.2, ACTUAL=A06, $
```

The following version of the request generates a relational table:

```
SET ASNAMES=OFF
TABLE FILE EMPLOYEE
SUM CURR_SAL AS SALARY PCT_INC
BY DEPARTMENT
ON TABLE HOLD FORMAT SQLMSS
END
```

The field names from the original Master File have been propagated to the field names in the HOLD Master File, and the alias names from the original Master File have been propagated to the HOLD Master File. The AS name for CURR_SAL has become the TITLE in the HOLD Master File:

```

FILENAME=HOLD    , SUFFIX=SQLMSS    , $
  SEGMENT=SEG01, SEGTYPE=S0, $
    FIELDNAME=DEPARTMENT, ALIAS=DPT, USAGE=A10, ACTUAL=A10, $
    FIELDNAME=CURR_SAL, ALIAS=CSAL, USAGE=D12.2M, ACTUAL=D8,
      TITLE='SALARY', $
    FIELDNAME=PCT_INC, ALIAS=PI, USAGE=F6.2, ACTUAL=F4, $

```

Changing SET ASNAMES to ON propagates the AS name SALARY to the field name in the HOLD Master File. The following is the Master File for the HOLD file in ALPHA format:

```

FILENAME=HOLD    , SUFFIX=FIX    , IOTYPE=STREAM, $
  SEGMENT=HOLD, SEGTYPE=S1, $
    FIELDNAME=DEPARTMENT, ALIAS=E01, USAGE=A10, ACTUAL=A10, $
    FIELDNAME=SALARY, ALIAS=E02, USAGE=D12.2M, ACTUAL=A12, $
    FIELDNAME=PCT_INC, ALIAS=E03, USAGE=F6.2, ACTUAL=A06, $

```

The following is the Master File for the HOLD file in relational format:

```

FILENAME=HOLD    , SUFFIX=SQLMSS    , $
  SEGMENT=SEG01, SEGTYPE=S0, $
    FIELDNAME=DEPARTMENT, ALIAS=DPT, USAGE=A10, ACTUAL=A10, $
    FIELDNAME=SALARY, ALIAS=CURR_SAL, USAGE=D12.2M, ACTUAL=D8,
      TITLE='SALARY', $
    FIELDNAME=PCT_INC, ALIAS=PI, USAGE=F6.2, ACTUAL=F4, $

```

Changing SET ASNAMES to FLIP propagates the AS name SALARY to the alias name in the HOLD Master File. In the ALPHA HOLD file, the other field names have been propagated to the alias names in the HOLD Master File, and default field names have been generated:

```

FILENAME=HOLD    , SUFFIX=FIX    , IOTYPE=STREAM, $
  SEGMENT=HOLD, SEGTYPE=S1, $
    FIELDNAME=F01, ALIAS=DEPARTMENT, USAGE=A10, ACTUAL=A10, $
    FIELDNAME=F02, ALIAS=SALARY, USAGE=D12.2M, ACTUAL=A12, $
    FIELDNAME=F03, ALIAS=PCT_INC, USAGE=F6.2, ACTUAL=A06, $

```

In the relational HOLD file, changing SET ASNAMES to FLIP propagates the AS name SALARY to the alias name in the HOLD Master File. For that field, the field name from the original Master File becomes the field name in the HOLD Master File and the TITLE attribute. The other field names have been propagated to the alias names in the HOLD Master File, and the corresponding alias names from the original Master File have been propagated to the field names in the HOLD Master File:

```

FILENAME=HOLD    , SUFFIX=SQLMSS    , $
SEGMENT=SEG01, SEGTYPE=S0, $
  FIELDNAME=DPT, ALIAS=DEPARTMENT, USAGE=A10, ACTUAL=A10, $
  FIELDNAME=CURR_SAL, ALIAS=SALARY, USAGE=D12.2M, ACTUAL=D8,
  TITLE='SALARY', $
  FIELDNAME=PI, ALIAS=PCT_INC, USAGE=F6.2, ACTUAL=F4, $

```

Controlling Fields in a HOLD Master File

You can use the SET HOLDLIST command to restrict fields in HOLD Master Files to those appearing in a request.

Control Fields in a HOLD File

```
SET HOLDLIST = {PRINTONLY|ALL|ALLKEYS|EXPLICIT}
```

where:

PRINTONLY

Specifies that only those fields that would appear in the report are included in the generated HOLD file. Non-displaying fields in a request (those designated as NOPRINT fields explicitly or implicitly) are not included in the HOLD file.

ALL

Specifies that all display fields referenced in a request appear in a HOLD file, including calculated values. ALL is the default value. OLD may be used as a synonym for ALL.

i **Note:** Vertical sort (BY) fields specified in the request with the NOPRINT option are not included in the HOLD file even if HOLDLIST=ALL.

ALLKEYS

Propagates all fields, including NOPRINTed BY fields.

EXPLICIT

Includes fields in the HOLD or PCHOLD file that are explicitly omitted from the report output using the NOPRINT option in the request, but does not include fields that are implicitly NOPRINTed. For example, if a field is reformatted in the request, two versions of the field exist, the one with the new format and the one with the original format, which is implicitly NOPRINTed

Note that SET HOLDLIST may also be issued from within a TABLE request. When used with MATCH, SET HOLDLIST always behaves as if HOLDLIST is set to ALL.

Using HOLDLIST=ALL

When HOLDLIST is set to ALL, the following TABLE request produces a HOLD file containing all specified fields, including NOPRINT fields and values calculated with the COMPUTE command.

```
SET HOLDLIST=ALL

TABLE FILE CAR
PRINT CAR MODEL NOPRINT
COMPUTE TEMPSEATS=SEATS+1;
BY COUNTRY
ON TABLE HOLD
END

? HOLD
```

The output is:

NUMBER OF RECORDS IN TABLE= 18			LINE=	18
DEFINITION OF HOLD FILE: HOLD				

FIELDNAME			ALIAS	FORMAT
COUNTRY			E01	A10
CAR			E02	A16
MODEL			E03	A24
SEATS			E04	I3
TEMPSEATS			E05	D12.2

Using HOLDLIST= PRINTONLY

When HOLDLIST is set to PRINTONLY, the following TABLE request produces a HOLD file containing only fields that would appear in report output:

```

SET HOLDLIST=PRINTONLY

TABLE FILE CAR
PRINT CAR MODEL NOPRINT
COMPUTE TEMPSEATS=SEATS+1;
BY COUNTRY
ON TABLE HOLD
END

? HOLD

```

The output is:

NUMBER OF RECORDS IN TABLE= 18			LINES=	18
DEFINITION OF HOLD FILE: HOLD				
FIELDNAME			ALIAS	FORMAT
COUNTRY			E01	A10
CAR			E02	A16
TEMPSEATS			E03	D12.2

Comparing Master Files Created Using Different HOLDLIST Settings

The following request against the GGSALES data source has two reformatted display fields (DOLLARS, UNITS). The DOLLARS field is also an explicit NOPRINT field. The BY field named CATEGORY is also an explicit NOPRINT field:

```
SET HOLDLIST=ALL
TABLE FILE GGSALES
SUM UNITS/I5 DOLLARS/D12.2 NOPRINT
```

```

BY REGION BY CATEGORY NOPRINT
ON TABLE HOLD FORMAT FOCUS
END

```

Running the request with SET HOLDLIST=ALL generates the following HOLD Master File. Note that the DOLLARS and UNITS fields are included twice, once with the original format (which would have been implicitly NOPRINTed if the report had been printed rather than held) and once with the new format. However the NOPRINTed BY field (CATEGORY) is not included:

```

FILENAME=HOLD, SUFFIX=FOC      , $
  SEGMENT=SEG01, SEGTYPE=S1, $
    FIELDNAME=REGION, ALIAS=E01, USAGE=A11,
      TITLE='Region', DESCRIPTION='Region code', $
    FIELDNAME=UNITS, ALIAS=E02, USAGE=I08,
      TITLE='Unit Sales', DESCRIPTION='Number of units sold', $
    FIELDNAME=UNITS, ALIAS=E03, USAGE=I5,
      TITLE='Unit Sales', $
    FIELDNAME=DOLLARS, ALIAS=E04, USAGE=I08,
      TITLE='Dollar Sales', DESCRIPTION='Total dollar amount of reported
sales', $
    FIELDNAME=DOLLARS, ALIAS=E05, USAGE=D12.2,
      TITLE='Dollar Sales', $

```

Running the request with SET HOLDLIST=ALLKEYS generates the following HOLD Master File. Note that the DOLLARS and UNITS fields are included twice, once with the original format, which would have been implicitly NOPRINTed if the report had been printed rather than held, and once with the new format. The NOPRINTed BY field (CATEGORY) is included:

```

FILENAME=HOLD, SUFFIX=FOC      , $
  SEGMENT=SEG01, SEGTYPE=S2, $
    FIELDNAME=REGION, ALIAS=E01, USAGE=A11,
      TITLE='Region', DESCRIPTION='Region code', $
    FIELDNAME=CATEGORY, ALIAS=E02, USAGE=A11,
      TITLE='Category', DESCRIPTION='Product category', $
    FIELDNAME=UNITS, ALIAS=E03, USAGE=I08,
      TITLE='Unit Sales', DESCRIPTION='Number of units sold', $
    FIELDNAME=UNITS, ALIAS=E04, USAGE=I5,
      TITLE='Unit Sales', $
    FIELDNAME=DOLLARS, ALIAS=E05, USAGE=I08,
      TITLE='Dollar Sales', DESCRIPTION='Total dollar amount of reported
sales', $

```

```
FIELDNAME=DOLLARS, ALIAS=E06, USAGE=D12.2,
TITLE='Dollar Sales', $
```

Running the request with SET HOLDLIST=PRINONLY generates the following HOLD Master File. Only the fields that would have actually printed on the report output are included: REGION and UNITS with the new format (I5). All explicitly and implicitly NOPRINTed fields are excluded, including the NOPRINTed BY field (CATEGORY):

```
FILENAME=HOLD , SUFFIX=FOC , $
SEGMENT=SEG01, SEGTYPE=S1, $
FIELDNAME=REGION, ALIAS=E01, USAGE=A11,
TITLE='Region', DESCRIPTION='Region code', $
FIELDNAME=UNITS, ALIAS=E02, USAGE=I5,
TITLE='Unit Sales', $
```

Running the request with SET HOLDLIST=EXPLICIT generates the following HOLD Master File. The fields that would have actually printed on the report output are included and so are the explicitly NOPRINTed fields (the display field DOLLARS and the BY field CATEGORY). The implicitly NOPRINTed fields (DOLLARS and UNITS with their original formats) are omitted:

```
FILENAME=HOLD, SUFFIX=FOC , $
SEGMENT=SEG01, SEGTYPE=S2, $
FIELDNAME=REGION, ALIAS=E01, USAGE=A11,
TITLE='Region', DESCRIPTION='Region code', $
FIELDNAME=CATEGORY, ALIAS=E02, USAGE=A11,
TITLE='Category', DESCRIPTION='Product category', $
FIELDNAME=UNITS, ALIAS=E03, USAGE=I5,
TITLE='Unit Sales', $
FIELDNAME=DOLLARS, ALIAS=E04, USAGE=D12.2,
TITLE='Dollar Sales', $
```

Controlling Attributes in the HOLD Master File

The SET HOLDATTR command controls whether the TITLE and ACCEPT attributes, as well as other attributes in the original Master File, are propagated to the HOLD Master File. SET HOLDATTR does not affect the way fields are named in the HOLD Master File.

Note that if a field in a data source does not have the TITLE attribute specified in the Master File, but there is an AS phrase specified for the field in a report request, the corresponding field in the HOLD file is named according to the AS phrase.

Control TITLE and ACCEPT Attributes

```
SET HOLDATTR =[ON|OFF|FOCUS|CUBE]
```

where:

ON

Uses the TITLE attribute as specified in the original Master File in HOLD files in any format. The ACCEPT attribute is propagated to the HOLD Master File only for HOLD files in FOCUS format. PROPERTY attributes are also propagated.

OFF

Does not use the TITLE or ACCEPT attributes from the original Master File in the HOLD Master File.

FOCUS

Uses the TITLE and ACCEPT attributes only for HOLD files in FOCUS format. PROPERTY attributes are also propagated. FOCUS is the default value.

CUBE

Propagates folders and DV_ROLE attributes, as well as TITLE attributes to the HOLD Master File. It also propagates the field name as the alias value.

Controlling TITLE and ACCEPT Attributes in a HOLD Master File

In this example, the Master File for the CAR data source specifies TITLE and ACCEPT attributes:

```
FILENAME=CAR2, SUFFIX=FOC  
SEGNAME=ORIGIN, SEGTYPE=S1
```

```

FIELDNAME =COUNTRY, COUNTRY, A10, TITLE='COUNTRY OF ORIGIN',
          ACCEPT='CANADA' OR 'ENGLAND' OR 'FRANCE' OR 'ITALY' OR
          'JAPAN' OR 'W GERMANY',
          FIELDTYPE=I,$
SEGNAME=COMP, SEGTYPE=S1, PARENT=ORIGIN
FIELDNAME=CAR, CARS, A16, TITLE='NAME OF CAR',$
.
.
.

```

Using SET HOLDATTR=FOCUS, the following request

```

SET HOLDATTR = FOCUS
TABLE FILE CAR2
PRINT CAR
BY COUNTRY ON TABLE HOLD FORMAT FOCUS AS HOLD5
END

```

produces this HOLD Master File:

```

FILE=HOLD5, SUFFIX=FOC
SEGMENT=SEG01, SEGTYPE=S02
FIELDNAME=COUNTRY ,USAGE=E01 ,ACTUAL=A10
TITLE='COUNTRY OF ORIGIN',
ACCEPT=CANADA ENGLAND FRANCE ITALY JAPAN 'W GERMANY', $
FIELDNAME=FOCLIST ,USAGE=E02 ,ACTUAL=I5 , $
FIELDNAME=CAR ,USAGE=E03 ,ACTUAL=A16 ,
TITLE='NAME OF CAR' , $

```

Keyed Retrieval From HOLD Files

Keyed retrieval is supported with any single-segment SUFFIX=FIX data source or HOLD file that is sorted based on the key. Keyed retrieval can reduce the IOs incurred in reading extract files, by using the SEGTYPE parameter in the Master File to identify which fields comprise the logical key for sequential files. When FIXRETRIEVE is:

- ON, the retrieval process stops when an equality or range test on the key holds true.
- OFF, all of the records from the sequential file are read and screening conditions are applied when creating the final report.

The ON TABLE HOLD command enables you to read one of the many supported data sources and create extract files. You can then join these fixed-format sequential files to other data sources to narrow your view of the data. The concept of a logical key in a fixed-format file enables qualified keyed searches for all records that match IF/WHERE tests for the first *n* KEY fields identified by the SEGTYPE attribute. Retrieval stops when the screening test detects values greater than those specified in the IF/WHERE test.

When a Master File is created for the extract file, a SEGTYPE of either *Sn* or *SHn* is added, based on the BY fields in the request. For example, the PRINT *field* BY *field* creates a HOLD Master File with SEGTYPE=S1. Using BY HIGHEST *field* creates a Master with SEGTYPE=SH1.

Control Keyed Retrieval for a HOLD File

```
SET FIXRET[RIEVE] = {ON|OFF}
```

where:

ON

Enables keyed retrieval. ON is the default setting.

OFF

Disables keyed retrieval.

Master File for Keyed Retrieval From a HOLD File

The following Master File describes a fixed-format sequential file with sorted values of SEQ_NO, in ascending order from 1 to 100,000.

```
FILE=SORTED,SUFFIX=FIX,$
SEGNAME=ONE,SEGTYPE=S1,$
FIELD=MYKEY,MK,I8,I8,$
FIELD=MFIELD,MF,A10,A10,$
```

```
TABLE FILE SORTED
PRINT MFIELD
WHERE MYKEY EQ 100
END
```

In this instance, with `FIXRETRIEVE=ON`, retrieval stops when `MYKEY` reaches 101, vastly reducing the potential number of IOs, as only 101 records are read out of a possible 100,000.

Selection Criteria for Keyed Retrieval From an Extract File

Selection criteria that include lists of equality values use keyed retrieval. For example,

```
{IF|WHERE} MYKEY EQ x OR y OR z
```

IF and WHERE tests can also include range tests. For example,

```
{IF|WHERE} MYKEY IS-FROM x TO y
```

The maximum number of vertical (BY) sort fields remains 32.

In using this feature, keep in mind that when adding unsorted records to a sorted HOLD file, records that are out of sequence are not retrieved. For example, suppose that a sorted file contains the following three records:

```
Key
```

```
1 1200
```

```
2 2340
```

```
3 4875
```

and you add the following record at the bottom of the file:

```
1 1620
```

With `FIXRETRIEVE=ON`, the new record with a key value of 1 is omitted, as retrieval stops as soon as a key value of 2 is encountered.

Using DBMS Temporary Tables as HOLD Files

You can create a report output file (that is, a HOLD file), as a native DBMS temporary table. This increases performance by keeping the entire reporting operation on the DBMS server, instead of downloading data to your computer and then back to the DBMS server.

For example, if you temporarily store report output for immediate use by another procedure, storing it as a temporary table instead of creating a standard HOLD file avoids the overhead of transmitting the interim data to your computer.

The temporary table columns are created from the following report elements

- Display columns
- Sort (BY) columns
- COMPUTE columns

except for those for which NOPRINT is specified.

The temporary table that you create from your report will be the same data source type (that is, the same DBMS) as the data source from which you reported. If the data source from which you reported contains multiple tables, all must be of the same data source type and reside on the same instance of the DBMS server.

You can choose between several types of table persistence.

You can create extract files as native DBMS tables with the following adapters:

- Db2
- Oracle
- Teradata

Save Report Output as a Native Temporary Table Using Commands

The syntax to save report output as a native DBMS temporary table is

```
ON TABLE HOLD [AS filename] FORMAT SAME_DB [PERSISTENCE persistValue]
```

where:

filename

Specifies the name of the HOLD file. If you omit *AS filename*, the name of the temporary table defaults to "HOLD".

Because each subsequent HOLD command overwrites the previous HOLD file, it is recommended to specify a name in each request to direct the extracted data to a separate file, thereby preventing an earlier file from being overwritten by a later one.

PERSISTENCE

Specifies the type of table persistence and related table properties. This is optional for DBMSs that support volatile tables, and required otherwise. For information about support for volatile tables for a particular DBMS, see [Temporary Table Properties for SAME_DB Persistence Values](#), and consult your DBMS vendor documentation.

persistValue

Is one of the following:

VOLATILE

Specifies that the table is local to the DBMS session. A temporary synonym (a Master File and Access File), is generated automatically. It expires when the FOCUS session ends.

This is the default persistence setting for all DBMSs that support volatile tables.

For information about support for the volatile setting, and about persistence and other table properties, for a particular DBMS, see [Temporary Table Properties for SAME_DB Persistence Values](#), and consult your DBMS vendor documentation.

GLOBAL_TEMPORARY

Specifies that while the table exists, its definition will be visible to other database sessions and users though its data will not be. A permanent synonym (a Master File and Access File), is generated automatically.

For information about support for the global temporary setting, and about persistence and other table properties, for a particular DBMS, see [Temporary Table Properties for SAME_DB Persistence Values](#), and consult your DBMS vendor documentation.

PERMANENT

Specifies that a regular permanent table will be created. A permanent synonym (a Master File and Access File), is generated automatically.

Temporary Table Properties for SAME_DB Persistence Values

The following chart provides additional detail about persistence and other properties of temporary tables of different data source types that are supported for use with HOLD format SAME_DB.

DBMS	VOLATILE	GLOBAL_TEMPORARY
Db2	Db2 on UNIX, Windows, and Db2 for z/OS: a volatile table is created using the DECLARE GLOBAL TEMPORARY TABLE command with the ON COMMIT PRESERVE ROWS option. Declared global temporary tables persist and are visible only within the current session (connection). SESSION is the schema name for all declared global temporary tables.	Db2 Release 7.1 and up for z/OS only: a global temporary table is created using the CREATE GLOBAL TEMPORARY TABLE command. The definition of a created global temporary table is visible to other sessions, but the data is not. The data is deleted at the end of each transaction (COMMIT or ROLLBACK command). The table definition persists after the session ends.
Oracle	This type of table is not supported by Oracle.	The table's definition is visible to all sessions; its data is visible only to the session that inserts data into it. The table's definition persists for the same period as the definition of a regular table.
Teradata	A volatile table definition and data are visible only within the session that created the table	A global temporary table persists for the same duration as a permanent table. The definition is visible to all sessions, but

DBMS	VOLATILE	GLOBAL_TEMPORARY
	and inserted the data. The volatile table is created with the ON COMMIT PRESERVE ROWS option.	the data is visible only to the session that inserted the data. The global temporary table is created with the ON COMMIT PRESERVE ROWS option.

Column Names in the HOLD File

Each HOLD file column is assigned its name:

1. From the AS name specified for the column in the report request.
2. If there is no AS name specified, the name is assigned from the alias specified in the synonym. (The alias is identical to the column name in the original relational table.)
3. In all other cases, the name is assigned from the field name as it is specified in the synonym.

Primary Keys and Indexes in the HOLD File

A primary key or an index is created for the HOLD table. The key or index definition is generated from the sort (BY) keys of the TABLE command, except for undisplayed sort keys (that is, sort keys for which NOPRINT is specified). To determine whether a primary key or an index will be created:

1. If these sort keys provide uniqueness and do not allow nulls (that is, if in the synonym, the MISSING attribute column is unselected or OFF), and if the DBMS supports primary keys on the type of table being created, a primary key is created.
2. If these sort keys provide uniqueness but either
 - a. some of the columns allow nulls.
 - b. the DBMS does not support primary keys on the type of table being created then a unique index is created.
3. If these sort keys do not provide uniqueness, a non-unique index is created.

4. If there are no displayed sort keys (that is, no sort keys for which NOPRINT has not been specified), no primary key or index is created.

Creating SAVE and SAVB Files

The SAVE command, by default, captures report output in ALPHA format as a simple sequential data source, without headings or subtotals. However, you can specify a variety of other formats for SAVE files, which are compatible with many software products. For example, you can specify SAVE formats to display report output in a webpage, a text document, a spreadsheet or word-processing application, or to be used as input to other programming languages. For a list of supported formats, see [Choosing Output File Formats](#).

Regardless of format, the SAVE command does not create a Master File.

The SAVB command is a variation on the SAVE command. SAVB creates a data source without a Master File, but numeric fields are stored in BINARY format. You can use the SAVB file as input to a variety of applications. SAVB output is the same as the default output created by the HOLD command.

Create a SAVE File

From a report request, use

```
ON TABLE SAVE [AS filename] [FORMAT fmt] [MISSING {ON|OFF}]
```

or

```
save_field SAVE [AS filename] [FORMAT fmt] [MISSING {ON|OFF}]
```

After a report is executed, use

```
SAVE [AS filename] [FORMAT fmt] [MISSING {ON|OFF}]
```

where:

save_field

Is the name of the last field in the request, excluding BY or ACROSS fields.

AS filename

Specifies a name for the SAVE file. If you do not specify a file name, SAVE is used as the default. Since each subsequent SAVE command overwrites the previous SAVE file, it is advisable to code a distinct file name in each request to direct the extracted data to a separate file, thereby preventing it from being overwritten by the next SAVE command.

FORMAT fmt

Specifies the format of the SAVE file. ALPHA is the default format.

- To display as or in a webpage:

```
HTML, HTMTABLE, DHTML
```

- To use in a text document:

```
ALPHA, DOC, PDF, WP
```

- To use in a spreadsheet application:

```
DIF, EXCEL, EXL2K, LOTUS, SYLK
```

- To use in a database application:

```
COMMA, COM, COMT
```

For details about all available formats, see [Choosing Output File Formats](#).

MISSING

Ensures that fields with the MISSING attribute set to ON are carried over into the SAVE file. MISSING OFF is the default attribute. See [Handling Records With Missing Field Values](#).

Creating a SAVE File

The following request extracts data from the EMPLOYEE data source and creates a SAVE file.

```
TABLE FILE EMPLOYEE
PRINT LAST_NAME AND FIRST_NAME
BY DEPARTMENT
ON TABLE SAVE
END
```

A description of the ALPHA (default SAVE format) file layout appears after the records are retrieved.

The output is:

NUMBER OF RECORDS IN TABLE=	12	LINES=	12
ALPHANUMERIC RECORD NAMED SAVE			
FIELDNAME	ALIAS	FORMAT	LENGTH
DEPARTMENT	DPT	A10	10
LAST_NAME	LN	A15	15
FIRST_NAME	FN	A10	10
TOTAL			35

Create a SAVB File

From a request, use

```
ON TABLE SAVB [AS filename] [MISSING {ON|OFF}]
```

or

```
save_field SAVB [AS filename] [MISSING {ON|OFF}]
```

After a report is executed, use

```
SAVB [AS filename] [MISSING {ON|OFF}]
```

where:

save_field

Is the name of the last field in the request, excluding BY and ACROSS fields.

AS filename

Specifies a name for the SAVB file. If you do not specify a file name, SAVB is used as the default. Since each subsequent SAVB command overwrites the previous SAVB file, it is advisable to code a distinct file name in each request to direct the extracted data to a separate file, thereby preventing it from being overwritten by the next SAVB command.

MISSING

Ensures that fields with the MISSING attribute set to ON are carried over into the SAVB file. The default is MISSING OFF. See [Handling Records With Missing Field Values](#).

Creating a SAVB File

The following request extracts data from the SALES data source and creates a SAVB file.

```
TABLE FILE SALES
PRINT PROD_CODE AND AREA
BY DATE
WHERE CITY IS 'STAMFORD' OR 'UNIONDALE'
ON TABLE SAVB
END
```

A description of the BINARY file appears after the records are retrieved.

The output is:

INTERNAL RECORD NAMED SAVB		ALIAS	FORMAT	LENGTH
FIELDNAME				
DATE		DTE	A4MD	4
PROD_CODE		PCODE	A3	4
AREA		LOC	A1	4
TOTAL				12

Creating a PCHOLD File

The PCHOLD command enables you to extract data from a WebFOCUS Reporting Server and return the output to a FOCUS client. See the *Overview and Operating Environments* manual for information about using FOCUS as a client to a Reporting server.

i Note: If your environment supports the SET parameter SAVEMATRIX, you can preserve the internal matrix of your last report in order to keep it available for subsequent HOLD, SAVE, and SAVB commands when the request is followed by Dialogue Manager commands. For details on SAVEMATRIX, see the *ibi™ FOCUS® Developing Applications* manual.

Create a PCHOLD File

The syntax for PCHOLD in a report request is

```
ON TABLE PCHOLD [AS filename] [FORMAT fmt] [DATASET name.ext]
```

where:

PCHOLD

Downloads HOLD files to a browser or other client application. HOLD AT CLIENT is a synonym for PCHOLD. The output is saved with a Master File. For details about the behavior of PCHOLD, see [Creating a HOLD File](#).

AS filename

Specifies a name for the PCHOLD file. If you do not specify a file name, PCHOLD becomes the default. Since each subsequent PCHOLD command overwrites the previous PCHOLD file, it is advisable to code a distinct file name in each request to direct the extracted data to a separate file, thereby preventing it from being overwritten by the next PCHOLD command.

FORMAT fmt

Specifies the format of the PCHOLD file. ALPHA is the default format.

- To display as or in a webpage, choose:

HTML, HTMTABLE, DHTML, VISDIS

- To display as a printed document, choose:

PDF, PS

- To use in a text document, choose:

ALPHA, DOC, WP

- To use in a spreadsheet application, choose:

DIF, XLSX, EXL2K [PIVOT], LOTUS

- To use for additional reporting, choose:

ALPHA, DFIX, COM, COMT, TAB, TABT

- To use in another application choose:

XML

- To generate active output, choose:

AHTML, APDF, AFLEX

For details about all available formats, see [Choosing Output File Formats](#).

DATASET name.ext

Is used with FORMAT ALPHA to specify a file name and extension for the report output.

Choosing Output File Formats

You can select from a wide range of output formats to preserve your report output for use in any of the following ways:

- To display as or in a webpage, as a printed document, or in a text document.

- To process in another application, such as a spreadsheet, a database, a word processor, or a 3GL program.
- To send to another location, such as a browser or PC.
- To extract a subset of the original data source in order to generate multi-step reports.

For details on each of the supported formats, including the commands that support them (HOLD, PCHOLD, SAVE) and the operating environments in which they are available, see the reference topics for the following formats.

AHTML	DFIX	HTML	POSTSCRIPT (PS)	SQLORA
ALPHA	DHTML	HTMTABLE	PPT	SQLPSTGR
BINARY	DIF	INGRES	PPTX	SQLSYB
COMMA	DOC	INTERNAL	REDBRICK	SYLK
COM	EXL2K	JSCHART	SQL	TAB
COMT	EXL2K FORMULA	JSON	SQL_SCRIPT	TABT
DATREC	EXL2K PIVOT	LOTUS	SQLDBC	WP
DB2	EXL97	PDF	SQLINF	XFOCUS
	FOCUS		SQLMSS	XLSX
			SQLODBC	XML

FORMAT AHTML

Description: Saves report output as an active report (HTML file that can be used for offline analysis and interactive functions without any connection to a server). All of the data and JavaScript code are stored within the HTML file, which also makes the output highly compressible for email and transparent to security systems.

Use: For offline analysis of data.

Supported with the commands: HOLD, PCHOLD, SAVE.

Available in: WebFOCUS, FOCUS.

FORMAT AHTMLTAB

Description: Creates an output file that contains only the data and parameters used in an HTML active report. The output produced is not a complete HTML active report. However, the file can be included in another HTML document using the Dialogue Manager command `-HTMLFORM`. For details, see the documentation on Dialogue Manager in the *ibi™ WebFOCUS® Developing Reporting Applications* manual.

Note: When issuing `HOLD AS name FORMAT AHTMLTAB` to embed an HTML active report into another HTML document, you must include Active Technologies JavaScript code into the HTML BODY using:

```
<BODY>
!IBI.OBJ.ACTIVEREPORTJS;
```

Use: For embedding HTML active reports into an existing HTML document.

Supported with the commands: HOLD, SAVE.

Available in: WebFOCUS.

FORMAT ALPHA

Description: Saves report output as fixed-format character data and can be created as a HOLD file.

ALPHA is the default SAVE format. The output file contains data only.

Text fields are supported in ALPHA-formatted files. See [Using Text Fields in Output Files](#).

To control missing data characters that are propagated to fields with the `MISSING=ON` attribute, use the `SET HNODATA` command. For more information, see the *ibi™ FOCUS® Developing Applications* manual.

Use: For display in a text document. For further reporting in FOCUS, WebFOCUS, or App Studio. As a transaction file for modifying a data source.

Supported with the commands: HOLD, PCHOLD, SAVE.

Available in: WebFOCUS, FOCUS.

FORMAT APDF

Description: Saves report output as an Adobe® Flex® report (Adobe® Flash® file) embedded in a PDF file. The resulting PDF active report can be used for offline analysis and interactive functions without any connection to a server.

In order to run a report created using the APDF format, Adobe Reader 9 or higher is required so the Flash run-time code included in the Acrobat client can render the Flash content.

Use: For offline analysis of data.

Supported with the command: HOLD, PCHOLD, SAVE.

Available in: FOCUS, WebFOCUS.

FORMAT BINARY

Description: Saves report data and stores numeric fields as binary numbers. When created as a HOLD file, it also creates a Master File.

BINARY is the default format for HOLD files. When created in BINARY format:

- The HOLD file is a sequential single-segment data source. The HOLD Master File is a subset of the original Master File, and may also contain fields that have been created using the COMPUTE or DEFINE commands or generated in an ACROSS phrase.
- By default, fields with format I remain four-byte binary integers. Format F fields remain in four-byte floating-point format. Format D fields remain in eight-byte double-precision floating-point, and format P fields remain in packed decimal notation and occupy eight bytes (for fields less than or equal to eight bytes long) or 16 bytes (for packed decimal fields longer than eight bytes). Alphanumeric fields (format A) are stored in character format.

Every data field in the sequential extract record is aligned on the start of a full four-byte word. Therefore, if the format is A1, the field is padded with three bytes of blanks on the right. This alignment makes it easier for user-coded subroutines to process these data fields. (Under some circumstances, you may wish to prevent the padding of integer and packed decimal fields. Do so with HOLD FORMAT INTERNAL. See [Saving Report Output in INTERNAL Format.](#))

The output file contains data only.

Use: For further reporting in FOCUS, WebFOCUS, or App Studio. As a transaction file for modifying a data source.

Supported with the commands: HOLD, SAVE.

Available in: WebFOCUS, FOCUS.

FORMAT COMMA

Description: Saves the data values as a variable-length text file, with fields separated by commas and with character values enclosed in double quotation marks. All blanks within fields are retained. This format is the industry standard comma-delimited format.

This format does not have the safety feature of the double quote added within a text field containing a double quote.

The extension for this format is PRN. This format type does not create a Master File.

Note:

- Smart date fields and dates formatted as I or P fields with date format options are treated as numeric, and are not enclosed in double quotation marks in the output file. Dates formatted as alphanumeric fields with date format options are treated as alphanumeric, and enclosed in double quotation marks.
- Continental decimal notation (CDN=ON|SPACE|QUOTE|QUOTEP) is not supported. A comma within a number is interpreted as two separate columns by a destination application such as Microsoft Access.

The output file contains data only.

Use: For further processing in a database application. This format type can be imported into applications such as Excel or Lotus.

Supported with the commands: HOLD, SAVE.

Available in: WebFOCUS, FOCUS.

FORMAT COM

Description: Saves the data values as a variable-length text file with fields separated by commas and with character values enclosed in double quotation marks. Leading blanks are removed from numeric fields, and trailing blanks are removed from character fields. To issue a request against this data source, the setting PCOMMA=ON is required.

This format also includes a built-in safety feature, which allows embedded quotes within character fields. A second double quote (") is inserted adjacent to the existing one. For example, if you input Joe "Smitty" Smith, the output is Joe ""Smitty"" Smith.

The extension for this format is CSV. A Master File is created for this format type when the command used to create the output file is HOLD. The SUFFIX in the generated Master File is COM.

**Note:**

- Smart date fields and dates formatted as I or P fields with date format options are treated as numeric, and are not enclosed in double quotation marks in the output file. Dates formatted as alphanumeric fields with date format options are treated as alphanumeric, and enclosed in double quotation marks.
- Continental decimal notation (CDN=ON|SPACE|QUOTE|QUOTEP) is not supported. A comma within a number is interpreted as two separate columns by a destination application such as Microsoft Access.
- To create a variable-length comma- or tab-delimited HOLD file that differentiates between a missing value and a blank string or zero value, use the SET NULL=ON command. For more information, see the *ibi™ FOCUS® Developing Applications* manual.

Use: For further processing in a database application. This format type can be imported into applications such as Excel or Lotus.

Supported with the commands: HOLD, SAVE, PCHOLD.

Available in: WebFOCUS, FOCUS.

FORMAT COMT

Description: Saves the column headings in the first row of the output file. It produces a variable-length text file with fields separated by commas, and with character values enclosed in double quotation marks. Leading blanks are removed from numeric fields, and trailing blanks are removed from character fields. This format is required by certain software packages such as Microsoft Access.

This format also includes a built-in safety feature, which allows embedded quotes within character fields. A second double quote (") is inserted adjacent to the existing one. For example, if you input Joe "Smitty" Smith, the output is Joe ""Smitty"" Smith.

The extension for this format is CSV. A Master File is created for this format type when the command used to create the output file is HOLD. The SUFFIX in the generated Master File is COMT.

i Note:

- Smart date fields and dates formatted as I or P fields with date format options are treated as numeric, and are not enclosed in double quotation marks in the output file. Dates formatted as alphanumeric fields with date format options are treated as alphanumeric, and enclosed in double quotation marks.
- Continental decimal notation (CDN=ON|SPACE|QUOTE|QUOTE) is not supported. A comma within a number is interpreted as two separate columns by a destination application such as Microsoft Access.
- To create a variable-length comma- or tab-delimited HOLD file that differentiates between a missing value and a blank string or zero value, use the SET NULL=ON command. For more information, see the *ibi™ FOCUS® Developing Applications* manual.

Use: For further processing in a database application. This format type can be imported into applications such as Excel or Lotus.

Supported with the commands: HOLD, SAVE, PCHOLD.

Available in: FOCUS, WebFOCUS.

FORMAT DATREC

Description: Saves report output as a sequential file with a Master File, and stores numeric fields as binary numbers without aligning them on fullword boundaries. The last field consists of one byte for each of the other fields in the Master File that indicates whether the corresponding field is missing.

Use: For further reporting in FOCUS, WebFOCUS, or App Studio. As a transaction file for modifying a data source.

Supported with the command: HOLD.

Available in: WebFOCUS, FOCUS.

FORMAT DB2

Description: Creates a Db2 table, if you have the Adapter for Db2 and permission to create tables.

Use: For further processing in a database application.

Supported with the command: HOLD.

Available in: WebFOCUS, FOCUS.

FORMAT DBASE

Description: Creates an extract file in dBase format that includes column headings in the first row.

i Note: Blank field names display as blank column titles. This may result in an error when attempting to use the file as input to various applications.

Use: For importing data to Windows-based applications such as MS Access and Excel.

Supported with the command: HOLD.

Available in: App Studio.

FORMAT DFIX

Description: Creates a delimited output file. You can specify the delimiter, whether alphanumeric fields should be enclosed within a special character such as a double quotation mark, and whether the file should be generated with a header record containing the field names.

For more information, see [Creating a Delimited Sequential File](#).

Use: For importing data to Windows-based applications such as MS Access and Excel.

Supported with the command: HOLD, PCHOLD.

Available in: WebFOCUS, FOCUS.

FORMAT DHTML

Description: Provides HTML output that has most of the features normally associated with output formatted for printing such as PDF or PostScript output. You can create an HTML file (.htm) or a Web Archive file (.mht). The type of output file produced is controlled by the value of the HTMLARCHIVE parameter. HTMLARCHIVE=ON creates a Web Archive file.

Some of the features supported by format DHTML are:

- **Absolute positioning.** DHTML precisely places text and images inside an HTML report, allowing you to use the same StyleSheet syntax to lay out HTML as you use for PDF or PS output.
- **On demand paging.** On demand paging is available with SET HTMLARCHIVE=OFF.
- **PDF StyleSheet features.** For example, the following features are supported: grids, background colors, OVER, bursting, coordinated compound reports.



Note:

- The font map file for DHTML reports is dhtml.fmp.
- Legacy compound reports are not supported.

Use: For display as a webpage.

Supported with the commands: HOLD, PCHOLD, SAVE.

Available in: WebFOCUS, FOCUS.

FORMAT DIF

Description: Captures the entire report output, excluding headings, footings, subheads, and subfoots, and creates a character file that can be easily incorporated into most spreadsheet packages.

For example, running a TABLE request with HEADING/FOOTING and ON TABLE HOLD FORMAT DIF does not display the report output with headings and footings. As a workaround, use another format (such as HTML, PDF, or EXL2K).

i Note: Microsoft Excel SR-1 is no longer supported for HOLD FORMAT DIF. To open these reports, use either Microsoft Excel SR-2 or Microsoft Excel 2000.

Use: For display or processing in a spreadsheet application.

Supported with the commands: HOLD, PCHOLD, SAVE.

Available in: WebFOCUS, FOCUS.

FORMAT DOC

Description: Captures the entire report output, including headings, footings, and subtotals, and creates a text file with layout and line breaks that can be easily incorporated into most word-processing packages. DOC format uses a form-feed character to indicate page control information.

i Note: A request that contains ON TABLE HOLD FORMAT DOC results in a blank first page in the report when displayed in Microsoft XP Office. To eliminate this, include SET PAGE=NOPAGE in your request.

Use: For display in a text document.

Supported with the commands: HOLD, PCHOLD, SAVE.

The PCHOLD variation transfers the data from a web server to a browser.

Available in: WebFOCUS, FOCUS.

FORMAT XLSX

Description: Generates fully styled reports in Excel 2007 XML format. You must have Excel 2007 or higher installed to use this output format. For details, see [Choosing a Styled Display Format](#).

An Excel 2007 worksheet can contain 1,048,576 rows by 16,384 columns. WebFOCUS will generate worksheets larger than these defined limits, but Excel 2007 will have difficulty opening the resulting workbook, and the data that exceeds the Excel 2007 limits will be truncated.

Use: For display or processing in a spreadsheet application.

Supported with the commands: HOLD, PCHOLD, SAVE.

For Internet Explorer, the PCHOLD variation launches Excel 2007 in the browser. For details, and for information about working with XLSX files, see [Choosing a Styled Display Format](#).

Available in: WebFOCUS.

FORMAT EXL2K

Description: Generates fully styled reports in Excel 2000 HTML format. You must have Excel 2000 installed to use this output format.

ACROSS column titles are supported for EXL2K output format.

For EXL2K output format, a report can include 65,536 rows and/or 256 columns. Rows and columns in excess of these limits are truncated from the worksheet when opened in Excel.

Use: For display or processing in a spreadsheet application.

Supported with the commands: HOLD, PCHOLD, SAVE.

For details, and for information about working with EXL2K files, see [Choosing a Styled Display Format](#).

Available in: WebFOCUS.

FORMAT EXL2K FORMULA

Description: Specifies that the report will be displayed as an Excel 2000 spreadsheet, with FOCUS totals and other calculated values translated to active Excel formulas. For details, see [Choosing a Styled Display Format](#).

Use: For display or processing in a spreadsheet application.

Supported with the commands: HOLD, PCHOLD, SAVE.

Available in: WebFOCUS, FOCUS.

FORMAT EXL2K PIVOT

Description: Generates fully styled reports in Excel 2000 HTML format, with added pivoting capabilities. Requires Excel 2000 on your PC.

Use: For display or processing in a spreadsheet application.

Supported with the commands: HOLD, PCHOLD, SAVE.

Available in: WebFOCUS, FOCUS.

FORMAT EXL97

Description: Enables you to view and save reports in Excel 97 that include full styling. For details on working with Excel formats, see [Choosing a Styled Display Format](#).

Leading zeros do not display for FORMAT EXL97.

Use: For display or processing in a spreadsheet application.

Supported with the command: HOLD, PCHOLD, SAVE.

Available in: FOCUS, WebFOCUS.

FORMAT FLEX

Description: Saves report output as an active report in an Adobe Flash player compatible (.swf) file that can be used for offline analysis and interactive functions without any connection to a server. Internet Explorer, Mozilla Firefox, and Opera internet browsers recognize an active report in the Adobe Flex format as a Shockwave Flash Object.

In order to run a report created using the Active Technologies for Adobe Flash player (FLEX) format, Adobe Flash Player 9.0.28 or higher is required.

Use: For offline analysis of data.

Supported with the command: HOLD, SAVE.

Available in: FOCUS, WebFOCUS.

FORMAT FOCUS

Description: Creates a FOCUS data source. Four files result: a HOLD data file, a HOLD Master File, and two work files. See [Holding Report Output in FOCUS Format](#).

Text fields are supported for FOCUS output files. See [Using Text Fields in Output Files](#).

Use: For further processing in a database application.

Supported with the command: HOLD.

Available in: WebFOCUS, FOCUS.

FORMAT GIF

Description: Saves the output of a graph request as a GIF file.

Use: The resulting GIF file can be embedded in the heading/footer or body of a PDF or HTML report. This technique is useful when you want to create a single PDF or HTML report that contains multiple outputs, such as output from a TABLE request and a GRAPH request. You can distribute this type of report using ReportCaster.

When running graphs in GIF format on a UNIX platform with the HEADLESS configuration, the graph may not display properly. You may see a red X instead of your image. This is due

to Sun's methodology of creating images without a head, which does not currently support GIF graphics.

Supported with the commands: HOLD.

Available in: WebFOCUS.

For details see [Creating a Graph](#).

FORMAT HTML

Description: Creates a complete HTML document that can be viewed in a web browser.

For more information, see Chapter 10, Styling Reports.

Use: For display as a webpage.

Supported with the commands: HOLD, PCHOLD, SAVE.

Available in: WebFOCUS, FOCUS.

FORMAT HTMTABLE

Description: Creates an output file that contains only an HTML table. The output produced is not a complete HTML document.

Internal cascading style sheets (CSS) are supported for FORMAT HTMTABLE. The CSS code is placed immediately before the TABLE command.

Use: For embedding reports and graphs in an existing HTML document.

Supported with the commands: HOLD, PCHOLD, SAVE.

Available in: WebFOCUS, FOCUS.

FORMAT INGRES

Description: Creates an Ingres table, if you have the Adapter for Ingres and permission to create tables.

Use: For further processing in a database application.

Supported with the command: HOLD.

Available in: WebFOCUS, FOCUS when used as a client to the WebFOCUS Reporting Server.

FORMAT INTERNAL

Description: Saves report output without padding the values of integer and packed fields. See [Saving Report Output in INTERNAL Format](#).

Use: For accurate processing by 3GL programs.

Supported with the command: HOLD, SAVB.

Available in: WebFOCUS, FOCUS.

FORMAT JPEG

Description: Saves the output of a graph request as a JPEG file.

Use: The resulting JPEG file can be embedded in the heading/footer or body of a PDF or HTML report. This technique is useful when you want to create a single PDF or HTML report that contains multiple outputs, such as output from a TABLE request and a GRAPH request. You can distribute this type of report using ReportCaster. JPEG (.jpg) files behave the same as GIF files.

 **Note:** For JPEG files, only the .jpg extension is supported. The .jpeg extension is not supported.

Supported with the commands: HOLD.

Available in: WebFOCUS.

For details, see [Linking From a Graphic Image](#) and [Adding an Image to a Report](#).

FORMAT JSCHART

Description: Saves the output of a graph request as an HTML5 graph.

Use: The charts are rendered in the browser as high-quality interactive vector graphics using a built-in JavaScript engine. Note that older browsers do not support all of the features of the HTML5 standard. You must include the following command to create an HTML5 graph:

```
ON GRAPH PCHOLD FORMAT JSCHART
```

Supported with the commands: ON GRAPH PCHOLD, ON GRAPH HOLD.

Available in: WebFOCUS.

For details, see [Creating an HTML5 Graph](#).

FORMAT JSON

Description: JSON (JavaScript Object Notation) is a plain text format that consists of the name: value pairs and is based on JavaScript. It can be parsed by many types of software and it is often used for storing and exchanging data. The field names and values in a report request can be held in a FORMAT JSON file. Subtotals, headings, footings, and ACROSS fields are not propagated to the HOLD file. A synonym is generated for the HOLD file. Adding the syntax STRUCTURE HIERARCHY to the HOLD command generates a JSON output file that identifies the sort fields and display fields in the request.

Use: For data interchange between systems and applications.

Supported with the commands: HOLD, PCHOLD

Available in: WebFOCUS, FOCUS

FORMAT LOTUS

Description: Captures all the columns of the report in a character file that LOTUS 1-2-3 can then import. All alphanumeric fields are enclosed in quotation marks. Columns are separated by commas.

Use: For display and processing in a spreadsheet application.

Supported with the commands: HOLD, PCHOLD, SAVE (WebFOCUS only).

Available in: WebFOCUS, FOCUS.

FORMAT PDF

Description: Saves the report output in Adobe Portable Document Format (PDF), which enables precise placement of output (all formatting options such as headings, footings, and titles) correctly aligned on the physical page, so the report looks exactly as it does when printed.

If you have a wide PDF report, it is automatically paneled. However, the PANEL parameter has no effect on FORMAT PDF.

A PDF object is a page, hyperlink, or image. The Portable Document Format (PDF) limits the number of objects that a PDF document can contain. FOCUS imposes the following object limits for each PDF report:

Object	Limit
Pages	10,000
Images	900
Hyperlinks per page	500
Total pages with hyperlinks	100
Total hyperlinks	44,500

PDF format retains all formatting options, such as a headings, footings, and titles.

The following fonts are supported: Courier (fixed width), Times (proportional width), and Helvetica (proportional width). PDF format maps all fonts to Courier, Helvetica, or Times. The font styles that can be used are Normal (default), Bold, Italic, Underline, and combinations of these.

The following StyleSheet features are supported with PDF: PAGESIZE, ORIENTATION, UNITS, TOPMARGIN, BOTTOMMARGIN, LEFTMARGIN, RIGHTMARGIN, POSITION, SQUEEZE, HGRID,

VGRID, BACKCOLOR. Note when you use BACKCOLOR with PDF reports, extra space is added to the top, bottom, right, and left of each cell of data in the report. This is for readability and to prevent data truncation.

Use: For display as a printed document. For information about compound reports and styling options, see [Choosing a Styled Display Format](#).

Supported with the commands: HOLD, PCHOLD, SAVE (WebFOCUS only).

Available in: WebFOCUS, FOCUS.

FORMAT PDF OPEN/CLOSE

Description: Saves multiple reports into one PDF report.

Use: For combining multiple reports into a single PDF file, also known as a compound report.

Supported with the command: PCHOLD.

Available in: WebFOCUS, FOCUS

FORMAT POSTSCRIPT (PS)

Description: Creates an output file in PostScript format, which supports headings, footings, and totals.

PS is an abbreviation for POSTSCRIPT.

PostScript format supports headings, footings, and totals. PS supports ISO Latin font encoding.

Use: For display as a printed document. For information about compound reports and styling options, see Chapter 10, Styling Reports.

Supported with the command: HOLD, PCHOLD.

Available in: WebFOCUS, FOCUS.

FORMAT PPT

Description: Creates an output file in PowerPoint® format in which each page of report output becomes a separate slide in the file with all styling applied.

Use: For use in a slide presentation.

Supported with the command: HOLD, SAVE.

Available in: WebFOCUS, FOCUS.

FORMAT PPTX

Description: Creates an output file in PowerPoint format in which each page of report output becomes a separate slide in the file with all styling applied.

Use: For use in a slide presentation.

Supported with the command: HOLD, SAVE.

Available in: WebFOCUS, FOCUS.

FORMAT REDBRICK

Description: Creates a Red Brick table, if you have the Adapter for Red Brick and permission to create tables.

Use: For further processing in a database application.

Supported with the command: HOLD.

Available in: WebFOCUS, FOCUS when used as a client to the WebFOCUS Reporting Server.

FORMAT SQL_SCRIPT

Description: Creates an SQL subquery file or a file of data values with a corresponding synonym.

When used in a request against a relational data source, the HOLD FORMAT SQL_SCRIPT command generates the SQL SELECT statement needed to execute the current query. It then stores it in the application folder as a file with a .sql extension, along with the Master and Access File pair that describes the SQL answer set.

When used in a request against any other type of data source, the HOLD FORMAT SQL_SCRIPT command executes the current query and stores the retrieved values in the application folder as a sequential file with a .ftm extension, along with the Master File that describes the retrieved data.

Use: You can use the output from HOLD FORMAT SQL_SCRIPT as the target file for the DB_INFILE function. For information about the DB_INFILE function, see the *ibi™ WebFOCUS® Using Functions* manual.

Supported with the command: HOLD.

Available in: WebFOCUS, FOCUS.

FORMAT SQLDBC

Description: Creates a Teradata table, if you have the Adapter for Teradata and permission to create tables.

Use: For processing in a database application.

Supported with the command: HOLD.

Available in: WebFOCUS, FOCUS.

FORMAT SQLINF

Description: Creates an Informix table, if you have the Adapter for Informix and permission to create tables.

Use: For processing in a database application.

Supported with the command: HOLD.

Available in: WebFOCUS, FOCUS when used as a client to the WebFOCUS Reporting Server.

FORMAT SQLMAC

Description: Creates a Microsoft Access table, if you have the Adapter for Microsoft Access and permission to create tables.

Use: For processing in a database application.

Supported with the command: HOLD.

Available in: WebFOCUS.

FORMAT SQLMSS

Description: Creates a Microsoft SQL Server table, if you have the Adapter for Microsoft SQL and permission to create tables.

Use: For processing in a database application.

Supported with the command: HOLD.

Available in: WebFOCUS, FOCUS when used as a client to the WebFOCUS Reporting Server.

FORMAT SQLODBC

Description: Creates an SQLODBC table if you have the current Adapter for ODBC and permission to create tables.

Use: For processing in a database application.

Supported with the command: HOLD.

Available in: WebFOCUS, FOCUS when used as a client to the WebFOCUS Reporting Server.

FORMAT SQLORA

Description: Creates an Oracle table, if you have the Adapter for Oracle and permission to create tables.

Use: For processing in a database application.

Supported with the command: HOLD.

Available in: WebFOCUS, FOCUS.

FORMAT SQLPSTGR

Description: Creates a PostgreSQL table, if you have the Adapter for PostgreSQL and permission to create tables.

Use: For processing in a database application.

Supported with the command: HOLD.

Available in: WebFOCUS, FOCUS when used as a client to the WebFOCUS Reporting Server.

FORMAT SQLSYB

Description: Creates a Sybase table, if you have the Adapter for Sybase and permission to create tables.

Use: For processing in a database application.

Supported with the command: HOLD.

Available in: WebFOCUS, FOCUS when used as a client to the WebFOCUS Reporting Server.

FORMAT SYLK

Description: Captures all the columns of the report request in a character file for Microsoft's spreadsheet program Multiplan. The generated file cannot have more than 9,999 rows.

Use: For display and processing in a spreadsheet application.

Supported with the command: HOLD, SAVE.

Available in: WebFOCUS, FOCUS.

FORMAT TAB

Description: Creates an output file in tab-delimited format. The TAB format includes a built-in safety feature, which allows embedded quotes within character fields. A second double quote (") is inserted adjacent to the existing one. For example, if you input Joe "Smitty" Smith, the output is Joe ""Smitty"" Smith. The TAB format also includes the following features:

- All trailing blanks are stripped from alpha [An] fields.
- All leading blanks are stripped from numeric [/Dx.y, /Fx.y, /Px.y, and /In] fields.
- There is a 32K record length limit in the output file.
- A Master File is created when the HOLD command is used to create the output file. The Master File behaves exactly as in FORMAT ALPHA, except for the inclusion of double quotes.

i Note: To create a variable-length comma- or tab-delimited HOLD file that differentiates between a missing value and a blank string or zero value, use the SET NULL=ON command. For more information, see the *ibi™ FOCUS® Developing Applications* manual.

Use: For importing data to Windows-based applications such as MS Access and Excel.

Supported with the command: HOLD, SAVE, PCHOLD.

Available in: WebFOCUS, FOCUS.

FORMAT TABT

Description: Creates an output file in tab-delimited format that includes column headings in the first row. The TABT format includes a built-in safety feature, which allows embedded quotes within character fields. A second double quote (") is inserted adjacent to the existing one. For example, if you input Joe "Smitty" Smith, the output is Joe ""Smitty"" Smith. The TABT format also includes the following features:

- The first row contains field names.
- All trailing blanks are stripped from alpha [An] fields.

- All leading blanks are stripped from numeric [/Dx.y, /Fx.y, /Px.y, and /In] fields.
- There is a 32K record length limit in the output file.
- A Master File is created when the HOLD command is used to create the output file. The Master File behaves exactly as in FORMAT ALPHA, except for the inclusion of double quotes.

i Note:

- Blank field names display as blank column titles. This may result in an error when attempting to use the file as input to various applications.
- To create a variable-length comma- or tab-delimited HOLD file that differentiates between a missing value and a blank string or zero value, use the SET NULL=ON command. For more information, see the *ibi™ FOCUS® Developing Applications* manual.

Use: For importing data to Windows-based applications such as MS Access and Excel.

Supported with the command: HOLD, SAVE, PCHOLD.

Available in: WebFOCUS, FOCUS.

FORMAT VISDIS

Description: WebFOCUS has a data visualization tool called Visual Discovery that creates graphs using a tab-delimited data file as input. The first record of the data file contains the column titles for the data values. The next record can contain the Visual Discovery field formats. If this record is not present, Visual Discovery attempts to determine the formats of the data fields by reading the first 50 records from the data file, a process that is not guaranteed to create accurate representations of the WebFOCUS formats.

The following table identifies format conversions for HOLD FORMAT VISDIS:

FOCUS Format	Visual Discovery Format
Integer	I
Decimal/Packed	R

FOCUS Format	Visual Discovery Format
Alphanumeric	S
Date format (smart date)	D%format%format%format (for example, D%Y%M%D). If the year is not a four-digit year, the format returned is S.
Other	S



Note: No Master File is created for format VISDIS.

Use: HOLD FORMAT VISDIS creates a tab-delimited output file with the extension .txt in which the first record has the column titles and the second record contains Visual Discovery formats based on the FOCUS field formats of the data.

Supported with the command: HOLD, SAVE, PCHOLD

Available in: WebFOCUS, FOCUS.

FORMAT WK1

Description: Captures all the columns of the report in a character file that LOTUS 1-2-3 Release 2 can then import.

Use: For display and processing in a spreadsheet application.

Supported with the commands: HOLD, PCHOLD.

Available in: App Studio.

FORMAT WP

Description: Captures the entire report output, including headings, footings, and subtotals, and creates a text file that can easily be incorporated into most word-processing packages.

Text fields are supported in WP format. See [Using Text Fields in Output Files](#).

To control whether a carriage control character is included in column 1 of each page of the report output, use:

```
[ON TABLE] HOLD AS filename FORMAT WP [CC|NOCC]
```

NOCC excludes carriage control characters. The position reserved for those characters remains in the file, but is blank. CC includes carriage control characters and creates the HOLD file with RECFM VBA. To include page control information in the WP file, you can also specify the TABPAGENO option in a heading or the SET PAGE=OFF command. The character 1 in the column 1 indicates the start of a new page.

The following rules summarize FORMAT WP carriage control options:

- The CC option always inserts the carriage control character.
- The NOCC option always omits the carriage control character.
- When you issue HOLD FORMAT WP without the CC or NOCC option:
 - SET PAGE NUM=OFF and SET PAGE NUM=TOP always insert the carriage control character.
 - SET PAGE NUM=NOPAGE always omits the carriage control character.
 - SET PAGE NUM=ON inserts the carriage control character if TABPAGENO is included in the heading and omits the carriage control character if TABPAGENO is not included in the heading.



Tip: HOLD FORMAT WP does not change the number of lines per page. In order to do so, issue one or a combination of the commands SET PRINT=OFFLINE, SET SCREEN=PAPER, or SET SCREEN=OFF.

The WP file is created with a record format of VB when the carriage control character is omitted and with a record format of VBA when the carriage control character is inserted.

The maximum record length for HOLD nFORMAT WP is 358 characters, 356 of which can represent data.

If you need the report width to remain fixed across releases for later processing of the output file, you can set the width you need to use the SET WPMINWIDTH command. This parameter specifies the minimum width of the output file. It will be automatically increased if the width you set cannot accommodate the fields propagated to the output file

in the request. The LRECL of the output file will be four bytes more than the report width because the file is variable length and needs an additional four bytes to hold the actual length of each record instance. In other operating environments, the length of the record is the value of WPMIDWIDTH.

FORMAT WP retains headings, footings, and subtotals.

Use: For display in a text document.

Supported with the commands: HOLD, PCHOLD, SAVE.

Available in: WebFOCUS, FOCUS.

FORMAT XFOCUS

Description: Creates an XFOCUS data source.

Use: For further processing in a database application.

Supported with the command: HOLD.

Available in: WebFOCUS, FOCUS.

FORMAT XML

Description: Creates an XML output file based on an internal DTD that includes the rows that are displayed in the final report output. It does not honor the HOLDLIST setting. It does not honor the ASNAMES setting. The parameter HOLDATTRS ON is automatically invoked. The XML file generated is based on the structure and layout of the report request. The metadata included in the DTD for each column is FIELDNAME, ALIAS, data type, width, FOCUS format, DESCRIPTION, ACCEPTS, HELP_MESSAGE, TITLE, WITHIN, PROPERTY, REFERENCE, VALIGN, and column title. FORMAT XML does not create a Master File.

i Note: When using an HTML Autoprompt page (select Run in new Window option), BI Portal, or an HTML page created with HTML canvas, browsers running in Standards Mode displaying output in an iframe do not display XML. When running a WebFOCUS request with PCHOLD FORMAT XML, the result will display in a new window.

Use: For further processing.

Supported with the command: HOLD, PCHOLD.

Available in: WebFOCUS, FOCUS.

Using Text Fields in Output Files

Text fields can be propagated to HOLD and SAVE files that have the following formats: ALPHA, WP, HTML, EXL2K, PDF, and FOCUS or XFOCUS. They can also be propagated to SAVB files. However, although a Master File is generated for format ALPHA, you cannot issue a TABLE request against a HOLD file of format ALPHA that contains text fields.

Rules for Text Fields in Output Files

- You can include as many text fields in the file as needed. However, you must specify text fields after non-text fields in the display list (PRINT..., SUM..., and so forth).
- You can specify only one text field in the display list, and no non-text fields, in a request that includes an ACROSS phrase.

The following rules apply to missing data for text fields in HOLD and SAVE files:

- A blank line is valid data. An end-of-text mark indicates the end of the field.
- If there is no text for a field, a single period (.) followed by blanks appears in the HOLD or SAVE file.
- If MISSING=ON during data extraction, a period (.) is written out to the HOLD or SAVE file.
- If MISSING=OFF during data extraction, a blank is written out to the HOLD or SAVE file.

See [Handling Records With Missing Field Values](#).

In environments that support FIXFORM, due to limitations in the use of text fields with FIXFORM, the following restriction applies:

- When you use the command FIXFORM FROM HOLD, the HOLD file may not contain more than one text field, and the text field must be the last field in the Master File.

When HOLD files are read using FIXFORM, the interpretation of missing text depends on whether the field's designation is MISSING=ON in the Master File, conditional ©) in the FIXFORM format description, or some combination of the two.

Applying Text Field Rules in HOLD Files

The following request extracts data to a HOLD file named CRSEHOLD:

```
TABLE FILE COURSES
PRINT COURSE_CODE DESCRIPTION
ON TABLE HOLD AS CRSEHOLD
END
```

This produces the following data in the HOLD file CRSEHOLD:

```
101 This course provides the DP professional with the skills
needed to create, maintain, and report from FOCUS databases.
%$
200 Anyone responsible for designing FOCUS databases will benefit
from this course, which provides the skills needed to design large,
complex databases and tune existing ones.
%$
201 This is a course in FOCUS efficiencies.
%$
```

The first record of the HOLD file contains data for COURSE_CODE 101, followed by the DESCRIPTION field. The data for this text field extends into the next record, beginning at Column 1, and continues to the end of the HOLD record. It is immediately followed by the end-of-text mark (%\$) on a line by itself. The next record contains new data for the next COURSE_CODE and DESCRIPTION.

If the report uses two text fields, the first record contains data for the first text field. After the end-of-text mark is written, the next text field appears. This formatting applies to all file formats except WP, in which the report is saved exactly as it appears on the screen.

Creating a Delimited Sequential File

You can use the HOLD FORMAT DFIX command to create an alphanumeric sequential file delimited by any character or combination of characters. You can also specify whether to

enclose alphanumeric values in quotation marks or some other enclosure, whether to include a header record that lists the names of the fields, whether to preserve leading and trailing blank spaces in alphanumeric data, and whether to insert a delimiter between records in the resulting file. (Note that when RDELIMITER is included, the RECFM is UB).

A Master File and an Access File are created to describe the delimited sequential file that is generated. The SUFFIX value in the Master File is DFIX. The Access File specifies the delimiter, the enclosure character (if any), whether to preserve leading and trailing blank spaces in alphanumeric data, whether there is a header record, and the record delimiter, if there is to be one. The Master and Access Files are useful if you will later read the sequential file using FOCUS.

Create a Delimited Sequential File

```
ON TABLE HOLD [AS filename] FORMAT DFIX
  DELIMITER delimiter
  [ENCLOSURE enclosure] [HEADER {YES|NO}]
  [PRESERVE SPACE {YES|NO}] [RDELIMITER rdelimiter]
```

where:

filename

Is the name of the file to be created. If you do not specify a name, the default name is HOLD.

delimiter

Is the delimiter sequence consisting of up to 30 printable or non-printable non-null characters. This represents character semantics. For example, if you are using DBCS characters, the delimiter can be up to 60 bytes. Characters may also be represented by their 0x hex values which is the required specification method for non-printable characters. If you use a mixture of printable and non-printable characters, you must enter them all as hexadecimal values. To create a tab delimited file, you can specify the DELIMITER value as **TAB** or as its hexadecimal equivalent (0x09 on ASCII platforms or 0x05 on EBCDIC platforms). To create a single-quote delimited file, you must specify the single quote DELIMITER value as its hexadecimal equivalent (0x27 on ASCII platforms or 0x7D on EBCDIC platforms), otherwise the request will be mis-interpreted and result in an unusable HOLD file.

enclosure

Is the enclosure sequence. It can be up to four printable or non-printable characters used to enclose each alphanumeric value in the file. This represents character semantics. For example, if you are using DBCS characters, the enclosure can be up to 8 bytes. Most alphanumeric characters can be used as all or part of the enclosure sequence. However, numeric digits and symbols used in numbers, such as a period (.), plus sign (+), or minus sign (-) cannot be used in the enclosure sequence. Also note that, in order to specify a single quotation mark as the enclosure character, you must enter four consecutive single quotation marks. The most common enclosure is one double quotation mark.

If you use a mixture of printable and non-printable characters, you must enter them all as hexadecimal values. For printable characters, you can either use the characters themselves or their hexadecimal equivalents (for example, the ampersand character may be interpreted as the beginning of a variable name rather than as part of the enclosure.)

HEADER {YES|NO}

Specifies whether to include a header record that contains the names of the fields in the delimited sequential file generated by the request.

PRESERVESPACE {YES|NO}

Specifies whether to retain leading and trailing blanks in alphanumeric data. YES preserves leading and trailing blanks. NO only preserves leading and trailing blanks that are included within the enclosure characters. NO is the default value.

i Note: PRESERVESPACE is overridden by the ENCLOSURE option. Therefore, exclude the enclosure option in order to have the PRESERVESPACE setting respected.

rdelimiter

Is the record delimiter sequence consisting of up to 30 printable or non-printable non-null characters. This represents character semantics. For example, if you are using DBCS characters, the delimiter can be up to 60 bytes. For a non-printable character, enter the hexadecimal value that represents the character. If you use a mixture of printable and non-printable characters, you must enter them all as hexadecimal values. For printable characters you can either use the characters themselves or their hexadecimal equivalents (for example, the ampersand character may be interpreted as the beginning

of a variable name rather than as part of the delimiter). To use a tab character as the record delimiter, you can specify the delimiter value as **TAB** or as its hexadecimal equivalent (0x09 on ASCII platforms or 0x05 on EBCDIC platforms). The comma (,) is not supported as a record delimiter.

Note that numeric digits and symbols used in numbers, such as a period (.), plus sign (+), or minus sign (-) cannot be used in the delimiter sequence. When RDELIMITER is included, the RECFM is UB.

Usage Notes for HOLD FORMAT DFIX

- Missing data is indicated by no data. So, with enclosure, a missing alphanumeric field is indicated by two enclosure characters, while a missing numeric field is indicated by two delimiters.
- Text fields are not supported with HOLD FORMAT DFIX.
- While HOLD FORMAT DFIX creates a single segment file, you can manually add segments to the resulting Master and Access File. In the Access File, you can specify a separate delimiter and/or enclosure for each segment.
- The extension of the generated sequential file is ftm.
- HOLD FORMAT DFIX with the PRESERVE SPACE YES option creates a file in which leading and trailing blank spaces are preserved in alphanumeric data. It also adds the attribute PRESERVE SPACE= YES in the Access File. This attribute causes leading and trailing blank spaces to be preserved when reading a FORMAT DFIX file.

Creating a Pipe-Delimited File

The following request against the CENTORD data source creates a sequential file named PIPE1 with fields separated by the pipe character (|). Alphanumeric values are not enclosed in quotation marks, and there is no header record:

```
TABLE FILE CENTORD
SUM QUANTITY LINEPRICE BY REGION BY YEAR
ON TABLE HOLD AS PIPE1 FORMAT DFIX DELIMITER |
END
```

The PIPE1 Master File specifies the SUFFIX value as DFIX:

```
FILENAME=PIPE1 , SUFFIX=DFIX , $
SEGMENT=PIPE1, SEGTYPE=S2, $
FIELDNAME=REGION, ALIAS=E01, USAGE=A5, ACTUAL=A05, $
FIELDNAME=YEAR, ALIAS=E02, USAGE=YY, ACTUAL=A04, $
FIELDNAME=QUANTITY, ALIAS=E03, USAGE=I8C, ACTUAL=A08, $
FIELDNAME=LINEPRICE, ALIAS=E04, USAGE=D12.2MC, ACTUAL=A12, $
```

The PIPE1 Access File specifies the delimiter:

```
SEGNAME=PIPE1, DELIMITER=|, HEADER=NO, $
```

The PIPE1 sequential file contains the following data. Each data value is separated from the next value by a pipe character:

```
EAST|2000|3907|1145655.77
EAST|2001|495922|127004359.88
EAST|2002|543678|137470917.05
NORTH|2001|337168|85750735.54
NORTH|2002|370031|92609802.80
SOUTH|2000|3141|852550.45
SOUTH|2001|393155|99822662.88
SOUTH|2002|431575|107858412.0
WEST|2001|155252|39167974.18
WEST|2002|170421|42339953.45
```

The following version of the HOLD command specifies both the delimiter and an enclosure character (“”):

```
ON TABLE HOLD AS PIPE1 FORMAT DFIX DELIMITER | ENCLOSURE "
```

The Master File remains the same, but the Access File now specifies the enclosure character:

```
SEGNAME=PIPE1, DELIMITER=|, ENCLOSURE=", HEADER=NO, $
```

In the delimited file that is created, each data value is separated from the next by a pipe character, and alphanumeric values are enclosed within double quotation marks:

```
"EAST" | 2000 | 3907 | 1145655.77
"EAST" | 2001 | 495922 | 127004359.88
"EAST" | 2002 | 543678 | 137470917.05
"NORTH" | 2001 | 337168 | 85750735.54
"NORTH" | 2002 | 370031 | 92609802.80
"SOUTH" | 2000 | 3141 | 852550.45
"SOUTH" | 2001 | 393155 | 99822662.88
"SOUTH" | 2002 | 431575 | 107858412.01
"WEST" | 2001 | 155252 | 39167974.18
"WEST" | 2002 | 170421 | 42339953.45
```

This version of the HOLD command adds a header record to the generated file:

```
ON TABLE HOLD AS PIPE1 FORMAT DFIX DELIMITER | ENCLOSURE " HEADER YES
```

The Master File remains the same, but the Access File now specifies that the generated sequential file should contain a header record with column names as its first record:

```
SEGNAME=PIPE1, DELIMITER=|, ENCLOSURE=", HEADER=YES, $
```

In the delimited file that is created, each data value is separated from the next by a pipe character, and alphanumeric values are enclosed within double quotation marks. The first record contains the column names:

```
"REGION" | "YEAR" | "QUANTITY" | "LINEPRICE"
"EAST" | 2000 | 3907 | 1145655.77
"EAST" | 2001 | 495922 | 127004359.88
"EAST" | 2002 | 543678 | 137470917.05
"NORTH" | 2001 | 337168 | 85750735.54
"NORTH" | 2002 | 370031 | 92609802.80
"SOUTH" | 2000 | 3141 | 852550.45
"SOUTH" | 2001 | 393155 | 99822662.88
"SOUTH" | 2002 | 431575 | 107858412.01
"WEST" | 2001 | 155252 | 39167974.18
"WEST" | 2002 | 170421 | 42339953.45
```

Creating a Tab-Delimited File

The following request against the CENTORD data source creates a sequential file named TAB1 with fields separated by a tab character:

```
TABLE FILE CENTORD
SUM QUANTITY LINEPRICE BY REGION BY YEAR
ON TABLE HOLD AS TAB1 FORMAT DFIX DELIMITER TAB
END
```

As the tab character is not printable, the TAB1 Access File specifies the delimiter using its hexadecimal value.

The following is the Access File in an EBCDIC environment:

```
SEGNAME=TAB1, DELIMITER=0x05, HEADER=NO, $
```

The following is the Access File in an ASCII environment:

```
SEGNAME=TAB1, DELIMITER=0x09, HEADER=NO, $
```

Creating a Delimited File With Blank Spaces Preserved

The following request against the GGSales data source creates a comma-delimited file. The original alphanumeric data has trailing blank spaces. The PRESERVE SPACE YES option in the HOLD command preserves these trailing blank spaces:

```
APP HOLDDATA APP1
APP HOLDMETA APP1
TABLE FILE GGSales
SUM DOLLARS UNITS
BY REGION
BY CATEGORY
BY PRODUCT
ON TABLE HOLD AS DFIX1 FORMAT DFIX DELIMITER , PRESERVE SPACE YES
END
```

The following Master File is generated:

```
FILENAME=DFIX1 , SUFFIX=DFIX , $
SEGMENT=DFIX1, SEGTYPE=S3, $
FIELDNAME=REGION, ALIAS=E01, USAGE=A11, ACTUAL=A11, $
```

```

FIELDNAME=CATEGORY, ALIAS=E02, USAGE=A11, ACTUAL=A11, $
FIELDNAME=PRODUCT, ALIAS=E03, USAGE=A16, ACTUAL=A16, $
FIELDNAME=DOLLARS, ALIAS=E04, USAGE=I08, ACTUAL=A08, $
FIELDNAME=UNITS, ALIAS=E05, USAGE=I08, ACTUAL=A08, $

```

The following Access File is generated:

```

SEGNAME=DFIX1, DELIMITER=',', HEADER=NO, PRESERVESPACE=YES, $

```

In the DFIX1 file, the alphanumeric fields contain all of the blank spaces that existed in the original file:

```

Midwest ,Coffee ,Espresso ,1294947,101154
Midwest ,Coffee ,Latte ,2883566,231623
Midwest ,Food ,Biscotti ,1091727,86105
Midwest ,Food ,Croissant ,1751124,139182
Midwest ,Food ,Scone ,1495420,116127
Midwest ,Gifts ,Coffee Grinder ,619154,50393
Midwest ,Gifts ,Coffee Pot ,599878,47156
Midwest ,Gifts ,Mug ,1086943,86718
Midwest ,Gifts ,Thermos ,577906,46587
Northeast ,Coffee ,Capuccino ,542095,44785
Northeast ,Coffee ,Espresso ,850107,68127
Northeast ,Coffee ,Latte ,2771815,222866
Northeast ,Food ,Biscotti ,1802005,145242
Northeast ,Food ,Croissant ,1670818,137394
Northeast ,Food ,Scone ,907171,70732
Northeast ,Gifts ,Coffee Grinder ,509200,40977
Northeast ,Gifts ,Coffee Pot ,590780,46185
Northeast ,Gifts ,Mug ,1144211,91497
Northeast ,Gifts ,Thermos ,604098,48870
Southeast ,Coffee ,Capuccino ,944000,73264
Southeast ,Coffee ,Espresso ,853572,68030
Southeast ,Coffee ,Latte ,2617836,209654
Southeast ,Food ,Biscotti ,1505717,119594
Southeast ,Food ,Croissant ,1902359,156456
Southeast ,Food ,Scone ,900655,73779
Southeast ,Gifts ,Coffee Grinder ,605777,47083
Southeast ,Gifts ,Coffee Pot ,645303,49922
Southeast ,Gifts ,Mug ,1102703,88474
Southeast ,Gifts ,Thermos ,632457,48976
West ,Coffee ,Capuccino ,895495,71168
West ,Coffee ,Espresso ,907617,71675
West ,Coffee ,Latte ,2670405,213920
West ,Food ,Biscotti ,863868,70436

```

West	,Food	,Croissant	,2425601,197022
West	,Food	,Scone	,912868,72776
West	,Gifts	,Coffee Grinder	,603436,48081
West	,Gifts	,Coffee Pot	,613624,47432
West	,Gifts	,Mug	,1188664,93881
West	,Gifts	,Thermos	,571368,45648

Creating the same file with PRESERVESPACE NO removes the trailing blank spaces:

```
Midwest,Coffee,Espresso,1294947,101154
Midwest,Coffee,Latte,2883566,231623
Midwest,Food,Biscotti,1091727,86105
Midwest,Food,Croissant,1751124,139182
Midwest,Food,Scone,1495420,116127
Midwest,Gifts,Coffee Grinder,619154,50393
Midwest,Gifts,Coffee Pot,599878,47156
Midwest,Gifts,Mug,1086943,86718
Midwest,Gifts,Thermos,577906,46587
Northeast,Coffee,Capuccino,542095,44785
Northeast,Coffee,Espresso,850107,68127
Northeast,Coffee,Latte,2771815,222866
Northeast,Food,Biscotti,1802005,145242
Northeast,Food,Croissant,1670818,137394
Northeast,Food,Scone,907171,70732
Northeast,Gifts,Coffee Grinder,509200,40977
Northeast,Gifts,Coffee Pot,590780,46185
Northeast,Gifts,Mug,1144211,91497
Northeast,Gifts,Thermos,604098,48870
Southeast,Coffee,Capuccino,944000,73264
Southeast,Coffee,Espresso,853572,68030
Southeast,Coffee,Latte,2617836,209654
Southeast,Food,Biscotti,1505717,119594
Southeast,Food,Croissant,1902359,156456
Southeast,Food,Scone,900655,73779
Southeast,Gifts,Coffee Grinder,605777,47083
Southeast,Gifts,Coffee Pot,645303,49922
Southeast,Gifts,Mug,1102703,88474
Southeast,Gifts,Thermos,632457,48976
West,Coffee,Capuccino,895495,71168
West,Coffee,Espresso,907617,71675
West,Coffee,Latte,2670405,213920
West,Food,Biscotti,863868,70436
West,Food,Croissant,2425601,197022
West,Food,Scone,912868,72776
West,Gifts,Coffee Grinder,603436,48081
West,Gifts,Coffee Pot,613624,47432
```



```
West,Gifts,Mug,1188664,93881
West,Gifts,Thermos,571368,45648
```

Specifying a Record Delimiter

The following request against the GGSALES data source, the field delimiter is a comma, the enclosure character is a single quotation mark, and the record delimiter consists of both printable and non-printable characters, so it is specified as the following hexadecimal sequence:

- 0x: character sequence identifying the delimiter as hexadecimal character codes.
- 2C: hexadecimal value for comma (,).
- 24: hexadecimal value for dollar sign (\$).
- 0D: hexadecimal value for carriage return.
- 0A: hexadecimal value for new line.

```
TABLE FILE GGSALES
PRINT DOLLARS UNITS CATEGORY REGION
ON TABLE HOLD AS RDELIM1 FORMAT DFIX DELIMITER , ENCLOSURE '''
HEADER NO RDELIMITER 0x2C240D0A
END
```

The generated Master File follows:

```
FILENAME=RDELIM1 , SUFFIX=DFIX , $
SEGMENT=RDELIM1, SEGTYPE=S0, $
FIELDNAME=DOLLARS, ALIAS=E01, USAGE=I08, ACTUAL=A08, $
FIELDNAME=UNITS, ALIAS=E02, USAGE=I08, ACTUAL=A08, $
FIELDNAME=CATEGORY, ALIAS=E03, USAGE=A11, ACTUAL=A11, $
FIELDNAME=REGION, ALIAS=E04, USAGE=A11, ACTUAL=A11, $
```

The Access File contains the delimiters and enclosure characters:

```
SEGNAME=RDELIM1,
DELIMITER=',',
ENCLOSURE='''',
HEADER=NO,
```

```
RDELIMITER=0x2C240D0A,
PRESERVESPACE=NO, $
```

Each row of the resulting DFIX file ends with the comma-dollar combination and a carriage return and line space. a partial listing follows:

```
20805,1387,'Coffee','Northeast',$
20748,1729,'Coffee','Northeast',$
20376,1698,'Coffee','Northeast',$
20028,1669,'Coffee','Northeast',$
19905,1327,'Coffee','Northeast',$
19470,1770,'Coffee','Northeast',$
19118,1738,'Coffee','Northeast',$
18720,1560,'Coffee','Northeast',$
18432,1536,'Coffee','Northeast',$
17985,1199,'Coffee','Northeast',$
17630,1763,'Coffee','Northeast',$
16646,1189,'Coffee','Northeast',$
15650,1565,'Coffee','Northeast',$
15450,1545,'Coffee','Northeast',$
15435,1029,'Coffee','Northeast',$
14270,1427,'Coffee','Northeast',$
```

Missing Data in the HOLD File

The following request against the CENTORD data source creates missing alphanumeric and numeric values in the resulting comma-delimited HOLD file:

```
DEFINE FILE CENTORD
AREA/A5 MISSING ON = IF REGION EQ 'EAST' THEN MISSING ELSE REGION;
MQANTITY/I9 MISSING ON = IF REGION EQ 'WEST' THEN MISSING ELSE 200;
END

TABLE FILE CENTORD
SUM QUANTITY MQANTITY LINEPRICE BY AREA BY YEAR
WHERE AREA NE 'NORTH' OR 'SOUTH'
ON TABLE HOLD AS MISS1 FORMAT DFIX DELIMITER , ENCLOSURE "
END
```

In the MISS1 HOLD file, the missing alphanumeric values are indicated by two enclosure characters in a row ("") and the missing numeric values are indicated by two delimiters in a row (,,):

```

",2000,3907,600,1145655.77
",2001,495922,343000,127004359.88
",2002,543678,343000,137470917.05
"WEST",2001,155252,,39167974.18
"WEST",2002,170421,,42339953.45

```

Saving Report Output in INTERNAL Format

HOLD files pad binary integer and packed decimal data values to a full word boundary. For example, a three-digit integer field (I3), is stored as four bytes in a HOLD file. In order for third-generation programs, such as COBOL, to be able to read HOLD files in an exact manner, you may need to save the fields in the HOLD file without any padding.

To suppress field padding in the HOLD file, you must reformat the fields in the request in order to override the default ACTUAL formats that correspond to the USAGE formats in the Master File:

- Reformat the integer and packed fields that you do not want to be padded in the HOLD file to the correct display lengths.
- Specify HOLD FORMAT INTERNAL for the report output.

Suppress Field Padding in HOLD Files

```

SET HOLDLIST = PRINTONLY
TABLE FILE filename
display_command fieldname/[In|Pn.d]
.
.
ON TABLE HOLD AS name FORMAT INTERNAL
END

```

where:

PRINTONLY

Causes your report request to propagate the HOLD file with only the specified fields displaying in the report output. If you do not issue this setting, an extra field containing

the padded field length is included in the HOLD file. See [Controlling Fields in a HOLD Master File](#).

fieldname/[In|Pn.d]

Specify correct lengths in the formats for integer and packed fields where you wish to suppress padding. These formats override the ACTUAL formats used for the display formats in the Master File. See [Usage Notes for Suppressing Padded Fields in HOLD Files](#).

Note that floating point double-precision (D) and floating point single-precision (F) are not affected by HOLD FORMAT INTERNAL.

FORMAT INTERNAL

Saves the HOLD file without padding for specified integer and packed decimal fields.

Usage Notes for Suppressing Padded Fields in HOLD Files

- Integer fields (I) of one, two, three, or four bytes produce four-byte integers without HOLD FORMAT INTERNAL.
- For packed decimal fields (Pn.d), *n* is the total number of digits and *d* is the number of digits to the right of the decimal point. The number of bytes is derived by dividing *n* by 2 and adding 1.

The syntax is

$$\text{bytes} = \text{INT} (n/2) + 1$$

where:

INT (n/2)

Is the greatest integer after dividing by 2.

- HOLD FORMAT INTERNAL does not affect floating point double-precision (D) and floating point single-precision (F) fields. D remains at eight bytes, and F at four bytes.
- Alphanumeric fields automatically inherit their length from their source Master File, and are not padded to a full word boundary.

- If a format override is not large enough to contain the data values, the values are truncated. Truncation may cause the data in the HOLD file to be incorrect in the case of an integer. For packed data and integers, truncation occurs for the high-order digits so the remaining low order digits resemble the digits from the correct values.
To avoid incorrect results, be sure that the format you specify is large enough to contain the data values.
- If you use the HOLDMISS=ON setting to propagate missing values to the HOLD file, short packed fields and fields with formats I1, I2, and I3 are not large enough to hold the missing value.

Creating a HOLD File Without HOLD FORMAT INTERNAL

In this example, the values of ACTUAL for RETAIL_COST, DEALER_COST, and SEATS are all padded to a full word. Alphanumeric fields also occupy full words.

```
TABLE FILE CAR
PRINT CAR COUNTRY RETAIL_COST DEALER_COST SEATS
ON TABLE HOLD AS DJG
END
```

The request creates the following Master File:

```
FILE=DJG, SUFFIX=FIX
SEGMENT=DJG, SEGTYPE=S0
FIELDNAME=CAR           ,ALIAS=E01   ,USAGE=A16   ,ACTUAL=A16   ,,$
FIELDNAME=COUNTRY      ,ALIAS=E02   ,USAGE=A10   ,ACTUAL=A12   ,,$
FIELDNAME=RETAIL_COST  ,ALIAS=E03   ,USAGE=D7    ,ACTUAL=D08   ,,$
FIELDNAME=DEALER_COST  ,ALIAS=E04   ,USAGE=D7    ,ACTUAL=D08   ,,$
FIELDNAME=SEATS        ,ALIAS=E05   ,USAGE=I3    ,ACTUAL=I04   ,,$
```

Creating a HOLD File With HOLD FORMAT INTERNAL

In this example, DEALER_COST and RETAIL_COST are defined in the Master File as D fields, but the request overrides RETAIL_COST as an I2 field and DEALER_COST as a P3 field.

```

SET HOLDLIST=PRINONLY
TABLE FILE CAR
PRINT CAR COUNTRY RETAIL_COST/I2 DEALER_COST/P3 SEATS/I1
ON TABLE HOLD AS HINT3 FORMAT INTERNAL
END

```

This creates the following Master File:

```

FILE=HINT3, SUFFIX=FIX
SEGMENT=HINT3, SEGTYPE=S0
FIELDNAME=CAR           ,ALIAS=E01   ,USAGE=A16  ,ACTUAL=A16  ,,$
FIELDNAME=COUNTRY      ,ALIAS=E02   ,USAGE=A10  ,ACTUAL=A10  ,,$
FIELDNAME=RETAIL_COST  ,ALIAS=E03   ,USAGE=I6   ,ACTUAL=I02  ,,$
FIELDNAME=DEALER_COST  ,ALIAS=E04   ,USAGE=P4   ,ACTUAL=P02  ,,$
FIELDNAME=SEATS        ,ALIAS=E05   ,USAGE=I4   ,ACTUAL=I01  ,,$

```

The ACTUAL formats for the overridden fields are I2, P2, and I1. DEALER_COST has an ACTUAL of P2 because P3, the format override, means 3 display digits that can be stored in 2 actual digits. Note that the alphanumeric field is also not padded.

Creating A Subquery or Sequential File With HOLD FORMAT SQL_SCRIPT

When used in a request against a relational data source, the HOLD FORMAT SQL_SCRIPT command generates the SQL SELECT statement needed to execute the current query and stores it in the application folder as a file with a .sql extension along with the Master and Access File pair that describes the SQL answer set.

When used in a request against any other type of data source, the HOLD FORMAT SQL_SCRIPT command executes the current query and stores the retrieved values in the application folder as a sequential file with a .ftm extension along with the Master File that describes the retrieved data.

You can use the output from HOLD FORMAT SQL_SCRIPT as the target file for the DB_INFILE function. For information about the DB_INFILE function, see the *ibi™ FOCUS® Developing Applications* manual.

i Note: Once you have the .sql file and its accompanying Master File, you can customize the .sql file using global Dialogue Manager variables. You must declare these global variables in the Master File. For information about parameterizing Master Files with global variables, see the *ibi™ FOCUS® Describing Data* manual.

Create an SQL Script or Sequential File Using HOLD FORMAT SQL_SCRIPT

```
ON TABLE HOLD AS script_name FORMAT SQL_SCRIPT
```

where:

script_name

Is the name of the .sql file or the .ftm file created as a result of the HOLD FORMAT SQL_SCRIPT command.

Creating an SQL Script File Using HOLD FORMAT SQL_SCRIPT

The following request against the WF_RETAIL relational data source creates an SQL Script file in the baseapp application:

```
APP HOLD baseapp
TABLE FILE WFLITE
SUM BUSINESS_REGION STATE_PROV_CODE_ISO_3166_2
BY BUSINESS_REGION NOPRINT BY STATE_PROV_CODE_ISO_3166_2 NOPRINT
WHERE BUSINESS_REGION EQ 'North America' OR 'EMEA'
WHERE STATE_PROV_CODE_ISO_3166_2 EQ 'AR' OR 'IA' OR 'KS' OR 'KY' OR 'WY'
OR 'CT' OR 'MA' OR '04' OR '11' OR '14'
OR 'NJ' OR 'NY' OR 'RI'
ON TABLE HOLD AS RETAIL_SCRIPT FORMAT SQL_SCRIPT
END
```

The result of this request is a script file named `retail_script.sql` and a corresponding Master and Access File.

The `retail_script.sql` file contains the following SQL SELECT statement:

```
SELECT          MAX(T3."BUSINESS_REGION") AS "VB001_MAX_BUSINESS_REGION",
(T3."STATE_PROV_CODE_ISO_3166_2")
AS "VB002_MAX_STATE_PROV_CODE_ISO_" FROM wrd_wf_retail_geography T3
WHERE (T3."STATE_PROV_CODE_ISO_3166_2" IN('AR', 'IA', 'KS', 'KY', 'WY',
'CT', 'MA', '04', '11', '14', 'NJ', 'NY', 'RI'))
AND (T3."BUSINESS_REGION" IN('North America', 'EMEA')) GROUP BY
T3."BUSINESS_REGION", T3."STATE_PROV_CODE_ISO_3166_2" MAX
```

The `retail_script.mas` Master File follows:

```
FILENAME=RETAIL_SCRIPT, SUFFIX=MSODBC , $
SEGMENT=RETAIL_SCRIPT, SEGTYPE=S0, $
FIELDNAME=BUSINESS_REGION, ALIAS=VB001_MAX_BUSINESS_REGION,
USAGE=A15V, ACTUAL=A15V,
MISSING=ON,
TITLE='Customer,Business,Region', $
FIELDNAME=STATE_PROV_CODE_ISO_3166_2, ALIAS=VB002_MAX_STATE_PROV_
CODE_ISO_, USAGE=A5V, ACTUAL=A5V,
MISSING=ON,
TITLE='Customer,State,Province,ISO-3166-2,Code', $
```

The `retail_script.acx` Access File follows:

```
SEGNAME=RETAIL_SCRIPT,
CONNECTION=CON01,
DATASET=RETAIL_SCRIPT.SQL,
SUBQUERY=Y, $
```

Creating a Sequential File Using HOLD FORMAT SQL_SCRIPT

The following request against the EMPLOYEE data source creates a sequential file containing the values retrieved by the request along with a corresponding Master File:

```
APP HOLD baseapp
TABLE FILE EMPLOYEE
PRINT LAST_NAME FIRST_NAME
WHERE DEPARTMENT EQ 'MIS'
ON TABLE HOLD AS EMPVALUES FORMAT SQL_SCRIPT
END
```

The sequential file empvalues.ftm contains the following data:

SMITH	MARY	JONES	DIANE	MCCOY
JOHN	BLACKWOOD	ROSEMARIE	GREENSPAN	MARY
CROSS	BARBARA			

The empvalues.mas Master File follows:

```
FILENAME=EMPVALUES, SUFFIX=DATREC , IOTYPE=BINARY, $
SEGMENT=EMPVALUE, SEGTYPE=S0, $
FIELDNAME=LAST_NAME, ALIAS=E01, USAGE=A15, ACTUAL=A15, $
FIELDNAME=FIRST_NAME, ALIAS=E02, USAGE=A10, ACTUAL=A10, $
FIELDNAME=NULLFLAG, ALIAS=__NULLFLAG__, USAGE=A2, ACTUAL=A2B,
ACCESS_PROPERTY=(INTERNAL), $
```

Creating a Structured HOLD File

Structured HOLD Files facilitate migration of data sources and reports between operating environments.

Other HOLD formats capture data from the original sources and may retain some implicit structural elements from the request itself. However, they do not propagate most of the information about the original data sources accessed and their inter-relationships to the HOLD Master File or data source. Structured HOLD files, however, extract the data to a structure that parallels the original data sources. Subsequent requests against the HOLD file can use these retained data relationships to recreate the same types of relationships in other environments or in other types of data sources.

A Structured HOLD File can be created in ALPHA, BINARY, or FOCUS format:

- A Structured HOLD file created in either ALPHA or BINARY format is a flat file that saves the segment instances that contain the data that satisfy the conditions of the TABLE request. Multiple segments are generated based on the original structure read

by the TABLE request. Segments are identified by assigning a RECTYPE for differentiation. Child segments in the original data source become a unique segment in the HOLD file

- A Structured HOLD file in FOCUS format uses normal FOCUS segments to retain the original structure.

In all cases the HOLD file contains all of the original segment instances required to provide the complete report based on the TABLE request itself. Regardless of the display command used in the original request (PRINT, LIST, SUM, COUNT), the Structured HOLD File is created as if the request used PRINT. Aggregation is ignored.

The HOLD file contains either all of the fields in the structure identified by the request that are used to satisfy the request, or all of the display fields and BY fields. The file does not contain DEFINE fields not specifically referenced in the request. It does contain all fields needed to evaluate any DEFINE fields referenced in the request.

Structured HOLD files are only supported for TABLE and TABLEF commands. They can be created anywhere a HOLD file is supported. You must activate Structured HOLD files in a specific request by issuing the ON TABLE SET EXTRACT command in the request prior to creating the Structured HOLD File.

Activate Structured HOLD Files for a Request

```
ON TABLE SET EXTRACT {ON|*|OFF}
```

where:

ON

Activates Structured HOLD Files for this request and extracts all fields mentioned in the request.

Activates Structured HOLD Files for this request and indicates that a block of extract options follows. For example, you can exclude specific fields from the Structured HOLD File. For information, see [Specify Options for Generating Structured HOLD Files](#).

OFF

Deactivates Structured HOLD files for this request. OFF is the default value.

Create a Structured HOLD File

Before issuing the HOLD command, activate Structured HOLD Files for the request by issuing the ON TABLE SET EXTRACT command described in [Activate Structured HOLD Files for a Request](#). Then issue the HOLD command to create the Structured HOLD File:

```
[ON TABLE] {HOLD|PCHOLD} [AS name] FORMAT {ALPHA|BINARY|FOCUS}
```

where:

name

Is the name of the HOLD file. If omitted, the name becomes HOLD by default.

FORMAT

Is ALPHA, BINARY or FOCUS.



Note: You can issue a SET command to set the default HOLD format to either ALPHA or BINARY:

```
SET HOLDFORMAT=ALPHA
SET HOLDFORMAT=BINARY
```

Specify Options for Generating Structured HOLD Files

To specify options for creating the extract, such as excluding specific fields, use the * option of the SET EXTRACT command:

```
ON TABLE SET EXTRACT *
EXCLUDE = (fieldname1, fieldname2, fieldname3 , ..., fieldnamen),$
FIELDS={ALL|EXPLICIT},$
ENDEXTRACT
ON TABLE HOLD AS name FORMAT {ALPHA|BINARY|FOCUS}
```

where:

EXCLUDE=(fieldname1, fieldname2, fieldname3,..., fieldnamen)

Excludes the specified fields from the HOLD file.

,\$

Is required syntax for delimiting elements in the extract block.

ALL

Includes all real fields and all DEFINE fields that are used in running the request.

EXPLICIT

Includes only those real fields and DEFINE fields that are in the display list or the BY sort field listing. DEFINE fields that are not explicitly referenced, and fields that are used to evaluate DEFINES, are not included.

ENDEXTRACT

Ends the extract block.

Creating a Structured HOLD File in ALPHA Format

```
TABLE FILE EMPLOYEE
PRINT LAST_NAME FIRST_NAME JOBCODE ED_HRS
BY DEPARTMENT
BY HIGHEST SALARY
ON TABLE SET EXTRACT ON
ON TABLE HOLD FORMAT ALPHA
END
```

This request produces the following HOLD Master File:

```
FILENAME=HOLD      , SUFFIX=FIX      , $
  SEGMENT=EMPINFO, SEGTYPE=S0, $
    FIELDNAME=RECTYPE, ALIAS=R, USAGE=A3, ACTUAL=A3, $
    FIELDNAME=LAST_NAME, ALIAS='LN', USAGE=A15, ACTUAL=A15, $
    FIELDNAME=FIRST_NAME, ALIAS='FN', USAGE=A10, ACTUAL=A10, $
    FIELDNAME=DEPARTMENT, ALIAS='DPT', USAGE=A10, ACTUAL=A10, $
    FIELDNAME=ED_HRS, ALIAS='OJT', USAGE=F6.2, ACTUAL=A06, $
  SEGMENT=PAYINFO, SEGTYPE=S0, PARENT=EMPINFO, $
    FIELDNAME=RECTYPE, ALIAS=1, USAGE=A3, ACTUAL=A3, $
    FIELDNAME=SALARY, ALIAS='SAL', USAGE=D12.2M, ACTUAL=A12, $
    FIELDNAME=JOBCODE, ALIAS='JBC', USAGE=A3, ACTUAL=A03, $
```

Note the RECTYPE field generated for ALPHA or BINARY Structured HOLD files. Each record in the HOLD file begins with the RECTYPE to indicate the segment to which it belonged in the original structure. The root segment has RECTYPE=R. The RECTYPES for other segments are sequential numbers assigned in top to bottom, left to right order.

Following are the first several records in the HOLD file:

```
R  STEVENS      ALFRED      PRODUCTION  25.00
1      11000.00A07
1      10000.00A07
R  SMITH        MARY        MIS          36.00
1      13200.00B14
R  JONES        DIANE       MIS          50.00
1      18480.00B03
1      17750.00B02
R  SMITH        RICHARD     PRODUCTION  10.00
1      9500.00A01
1      9050.00B01
```

Creating a Structured HOLD File in ibi FOCUS Format

```
TABLE FILE EMPLOYEE
PRINT LAST_NAME FIRST_NAME JOBCODE ED_HRS
BY DEPARTMENT
BY HIGHEST SALARY
ON TABLE SET EXTRACT ON
ON TABLE HOLD FORMAT FOCUS
END
```

This request produces the following HOLD Master File:

```
FILENAME=HOLD      , SUFFIX=FOC      , $
  SEGMENT=EMPINFO, SEGTYPE=S0, $
    FIELDNAME=LAST_NAME, ALIAS='LN', USAGE=A15, $
    FIELDNAME=FIRST_NAME, ALIAS='FN', USAGE=A10, $
    FIELDNAME=DEPARTMENT, ALIAS='DPT', USAGE=A10, $
    FIELDNAME=ED_HRS, ALIAS='OJT', USAGE=F6.2, $
  SEGMENT=PAYINFO, SEGTYPE=S0, PARENT=EMPINFO, $
    FIELDNAME=SALARY, ALIAS='SAL', USAGE=D12.2M, $
    FIELDNAME=JOBCODE, ALIAS='JBC', USAGE=A3, $
```

Reconstituting a Structured HOLD File

The following request reconstitutes the original FOCUS data source from the Structured HOLD File created in the example named *Creating a Structured HOLD File in ALPHA Format*:

```
TABLE FILE HOLD
PRINT LAST_NAME FIRST_NAME JOBCODE ED_HRS
BY DEPARTMENT
BY HIGHEST SALARY
ON TABLE SET EXTRACT ON
ON TABLE HOLD AS RECONST FORMAT FOCUS
END
```

This request produces the following Master File:

```
FILENAME=RECONST      , SUFFIX=FOC      , $
  SEGMENT=EMPINFO, SEGTYPE=S0, $
    FIELDNAME=LAST_NAME, ALIAS='LN', USAGE=A15, $
    FIELDNAME=FIRST_NAME, ALIAS='FN', USAGE=A10, $
    FIELDNAME=DEPARTMENT, ALIAS='DPT', USAGE=A10, $
    FIELDNAME=ED_HRS, ALIAS='OJT', USAGE=F6.2, $
  SEGMENT=PAYINFO, SEGTYPE=S0, PARENT=EMPINFO, $
    FIELDNAME=SALARY, ALIAS='SAL', USAGE=D12.2M, $
    FIELDNAME=JOBCODE, ALIAS='JBC', USAGE=A3, $
```

The following request prints the report output:

```
TABLE FILE RECONST
PRINT LAST_NAME FIRST_NAME JOBCODE ED_HRS
BY DEPARTMENT
BY HIGHEST SALARY
END
```

The output is:

DEPARTMENT	SALARY	LAST_NAME	FIRST_NAME	JOBCODE	ED_
HRS					
-----	-----	-----	-----	-----	-----
-					
MIS	\$27,062.00	CROSS	BARBARA	A17	
45.00					

45.00	\$25,775.00	CROSS	BARBARA	A16
75.00	\$21,780.00	BLACKWOOD	ROSEMARIE	B04
50.00	\$18,480.00	JONES	DIANE	B03
.00		MCCOY	JOHN	B02
50.00	\$17,750.00	JONES	DIANE	B02
36.00	\$13,200.00	SMITH	MARY	B14
25.00	\$9,000.00	GREENSPAN	MARY	A07
25.00	\$8,650.00	GREENSPAN	MARY	B01
PRODUCTION .00	\$29,700.00	BANNING	JOHN	A17
30.00	\$26,862.00	IRVING	JOAN	A15
30.00	\$24,420.00	IRVING	JOAN	A14
5.00	\$21,120.00	ROMANS	ANTHONY	B04
50.00	\$16,100.00	MCKNIGHT	ROGER	B02
50.00	\$15,000.00	MCKNIGHT	ROGER	B02
25.00	\$11,000.00	STEVENS	ALFRED	A07
25.00	\$10,000.00	STEVENS	ALFRED	A07
10.00	\$9,500.00	SMITH	RICHARD	A01
10.00	\$9,050.00	SMITH	RICHARD	B01

Excluding Fields From Structured HOLD Files

This request excludes the SALARY field used for sequencing.

```
TABLE FILE EMPLOYEE
PRINT LAST_NAME FIRST_NAME JOBCODE ED_HRS
```

```

BY DEPARTMENT
BY HIGHEST SALARY
ON TABLE SET EXTRACT *
EXCLUDE=(SALARY), $
ENDEXTRACT
ON TABLE HOLD FORMAT FOCUS
END

```

This request produces the following HOLD Master File:

```

FILENAME=HOLD      , SUFFIX=FOC      , $
SEGMENT=EMPINFO, SEGTYPE=S0, $
  FIELDNAME=LAST_NAME, ALIAS='LN', USAGE=A15, $
  FIELDNAME=FIRST_NAME, ALIAS='FN', USAGE=A10, $
  FIELDNAME=DEPARTMENT, ALIAS='DPT', USAGE=A10, $
  FIELDNAME=ED_HRS, ALIAS='OJT', USAGE=F6.2, $
SEGMENT=PAYINFO, SEGTYPE=S0, PARENT=EMPINFO, $
  FIELDNAME=JOBCODE, ALIAS='JBC', USAGE=A3, $

```

Elements Included in a Structured HOLD File

Structured HOLD files contain all original segment instances required to complete the TABLE or TABLEF request. Regardless of the display command used in the original request (PRINT, LIST, SUM, or COUNT), the structured HOLD file will be created as if the command was PRINT.

Specifically, the extract file contains the following elements:

- All real fields named in the request such as display objects, sort fields, and fields used in selection criteria (WHERE/IF tests).

Note that fields referenced multiple times in a request are included only once in the HOLD file.

- Fields used in FILTER FILE condition.
- Prefix operators are ignored except for ALL. (which just affects the amount of data collected and does not imply a calculation).
- Field based reformatting (FIELD1/FIELD2=) causes the original field and the format field to be included.

- A GROUP field if referenced explicitly or when all of its members are referenced in the request.

i Note: If a group member is specifically excluded (EXCLUDE) or not referenced, its GROUP is not added to the extract Master File (this applies to nested and overlapping groups, as well). If a GROUP and its elements are all named in a request, the GROUP is not added as a real field in the extract HOLD file.

- For FIELDS=ALL, all DEFINE fields used in the request become real fields in the structured HOLD File and are included along with other fields used in the DEFINE expression (including other DEFINE fields). Use EXCLUDE to reduce the number of fields included in the EXTRACT output.
- For FIELDS=EXPLICIT, display objects and sort fields are included. DEFINE fields become real fields if referenced in the request, but fields used to create them will not be included unless referenced explicitly. This reduces the number of fields returned in the request.

Elements Not Included in a Structured HOLD File

- Prefix operators on WHERE fields are evaluated in data selection but not included in the extract output.
- Prefix operators on display objects are ignored (except ALL).
- Using Structured HOLD File syntax in MATCH, MORE, and GRAPH requests produces error messages and exits the procedure.
- WHERE/IF TOTAL tests are not supported in Structured HOLD File requests and result in cancellation of the request.
- Reformatting of real fields is ignored (only the real field is included).
- Computed fields are not included, but fields used in COMPUTE expressions are included in the extract file.

Structural and Behavioral Notes

- Structured HOLD File requests are subject to the same limitations on the number and size of fields as any other TABLE request.

Structural Notes

- The following SET parameters are turned off or ignored in Structured HOLD File requests:
 - AUTOINDEX
 - AUTOPATH
 - AUTOSTRATEGY
 - EXTHOLD
 - EXTSORT
 - HOLDATTR
 - All SET and ON TABLE SET commands used to control output format are ignored in creating the extract file.
- Alternate views are respected and reflected in the structure of the extract file.
- Indexed views specified in the request are respected and reflected in the structure of the output file.
- If a request would generate a file containing two independent orphan segments because the parent segment is specifically excluded, a dummy system segment is created in the to act as parent of the two unrelated segments. There is only one instance of data for that segment. Both orphan segments refer to that system segment as parent. If the parent is missing because it was not mentioned in the request, it is activated during the request and included as the parent the segments.
- In the event that two unique (U) segments are included without the parent segment, the unique segments are converted to segments with SEGTYPE S0 that reference the system segment as parent.
- JOIN and JOIN WHERE structures are supported.

SQL Optimization Notes

- SQL optimization for aggregation must be turned off for EXTRACT requests.

BY/ACROSS/FOR Notes

- BY and ACROSS sort fields become additional display objects.
- BY. . .ROWS and ACROSS . . .COLUMNS function only as implicit WHEREs to limit field values included.
- FOR fields are included.
- RECAP fields are excluded (like COMPUTEs).
- Summarization fields referencing previously identified fields are ignored in creating Structured HOLD Files. These include: SUMMARIZE, RECOMPUTE, SUBTOTAL, SUBTOTAL ACROSS-TOTAL, ROW-TOTAL and COLUMN-TOTAL.

Formatting Notes

- Structured HOLD File processing ignores all formatting elements, including: IN, OVER, NOPRINT, SUP-PRINT, FOLD-LINE, SKIP-LINE, UNDER-LINE, PAGE-BREAK, TABPAGENO, AS, and column title justification. However, fields referenced within formatting commands, such as HEADING, FOOTING, SUBHEAD, and SUBFOOT, and any WHEN expressions associated with them, are included.
- All STYLE and STYLESHEET commands are ignored in producing extract output.
- AnV and AnW fields are supported. TX fields are exported in FOCUS files only.
- In the event that the FIELDNAME and ALIAS are the same for a real field and that field is redefined as itself (possibly with a different format), two fields are created in the HOLD Master File with identical field names and aliases. In this situation, the second version of the field can never be accessed if referenced by name. You can use FIELDS=EXPLICIT to include only the second version of the field. The following DEFINE illustrates an example of creating a duplicate field name and alias:

```
DEFINE FILE CAR
  COUNTRY/A25=COUNTRY;
END
```

DBA Notes

- DBA controls on source files are respected when running Structured HOLD File requests with the exception of RESTRICT=NOPRINT, where fields named in a request are not displayed (such fields cannot be exported and should be specifically EXCLUDED).
- DBA restrictions do not carry over to the HOLD Master File.

Reconstituting Extract Files

- To reconstitute a FOCUS or flat file from a Structured HOLD file, you use the same syntax used to generate the Structured HOLD File. The ON TABLE SET EXTRACT syntax must be used to preserve multipath structures.
- All reconstituted FOCUS segments are SEGTYPE=S0, as neither KEY nor INDEX information is retained. An INDEX can be reinserted using REBUILD INDEX.

Styling Reports

A styled report is a report produced as format HTML, PDF, PostScript, Excel 2000, or Excel 97 that uses different default and/or user-specified formats from a standard FOCUS report. You can specify various characteristics of your report and format report components individually using a StyleSheet, or you can let the report be created using the default styles associated with these output formats.

A StyleSheet enables you to format and produce attractive reports that highlight key information.

You can use a StyleSheet to:

- Format report components individually.
- Format data that meets specified conditions.
- Create macros that enable you to streamline your formatting specifications.

Some advanced features of styled reports work differently depending on which format you choose for your report output. For detailed information about working with each type of styled output format, see [Choosing a Styled Display Format](#).

Introduction to Styled Reports

A StyleSheet describes how you want your report to look. You can create a StyleSheet within a report request or as a separate file. Either way, it consists of a series of declarations. Each declaration identifies a report component whose characteristics you wish to define (such as a heading, column, or grand total) and describes the desired characteristics of that component.

For HTML reports, you can also use external cascading style sheets and enable internal cascading style sheets. For details, see [Cascading Style Sheets](#).

Unless otherwise noted, all StyleSheet references in this document refer to FOCUS StyleSheets.

Style sheets enable you to create extremely detailed formats for every line, column, or value in your report. In most cases, you will want to use the formatting facilities judiciously

to make important information stand out. FOCUS has its own StyleSheets and also supports cascading style sheets for HTML reports, as described in [Cascading Style Sheets](#).

For some types of formatting you can choose between using a style sheet or report syntax. Style sheets enable you to centralize and reuse formatting logic. This provides you with several advantages:

- **Productivity.** By using just a few lines of code on a single style sheet you can format dozens of reports, reducing the development time of each report.
- **Easy maintenance.** You can change formatting for dozens of reports at one time by editing a single style sheet.
- **Consistent appearance.** Your enterprise can guarantee a consistent look for its reports by assigning the same style sheets to them.
- **Rapid reformatting.** You can change the appearance of a report quickly and easily by switching the style sheet assigned to it.
- **Prioritizing.** You can focus on your first priority report content because you can quickly address the report presentation by applying an existing style sheet.

You can apply several formatting techniques to save yourself time and effort. Most of these techniques enable you to use code provided for you by FOCUS, or to leverage code that you write yourself:

- **Inheritance and overrides.** Each report component inherits attributes from its *parent* report component. This powerful feature lets you define common formatting in a single declaration for a parent component, and lets descendant components automatically inherit the formatting, while enabling you to override the inherited values when you wish. By designing your StyleSheet to take advantage of inheritance, you can write less code and quickly update formatting for multiple report components.

For example, if you declare all the report's data to be blue, all data in all columns will be displayed as blue; if you also declare all vertical sort (BY) columns to be orange, this will override the blue for sort columns, which will be displayed as orange; and if you also declare the EMP_ID sort column green, this will override the orange and be displayed as green. For more information, see [FOCUS StyleSheet Attribute Inheritance](#).

- **Macros.** If you are going to specify the same attribute and value in several declarations in a StyleSheet, you can create a macro that enables you to apply the attribute repeatedly throughout the StyleSheet without coding it each time. Then, if you need to change the value, you can change it once in the macro and have the

change applied automatically throughout the StyleSheet.

- **Samples.** FOCUS comes with several sample StyleSheets, which you can apply to a report. You can also use a sample as a template, first copying it and then customizing the copy.
- **Defaults.** Many FOCUS StyleSheet attributes have default values. Instead of explicitly specifying every attribute, you can omit some and accept their defaults. For example, you can accept the default font instead of specifying a font. You can find each attribute's default value documented where its syntax is described.

For example, if there are several parts of a report that you wish to emphasize (such as titles of important columns, data values that exceed a threshold, and sort headings), and you want all of these to be bold and purple, you can define a macro that sets font style to bold and color to purple, and then apply the macro to all of these report components.

Specifying Formatting for the Order Revenue Report

This report displays the order number, order date, and total order revenue for Century Corporation for the third quarter of 2001:

Century Corporation		
Order Revenue - 2001 Q3		
page 1		
Date Of Order:	Order Number:	Order Total:
Oct 1, 01	59613	\$1,556.37
Oct 2, 01	58360	\$5,894.04
Oct 3, 01	59327	\$672,994.57
Oct 4, 01	58373	\$2,817.45
Oct 6, 01	54577	\$220,408.00
Oct 7, 01	68950	\$3,887.45
Oct 9, 01	48840	\$4,587.05
Oct 10, 01	48922	\$964,642.12
Oct 11, 01	48974	\$133,720.98

The report is formatted by a FOCUS StyleSheet and by formatting commands in the report procedure itself. The procedure is shown below, followed by the StyleSheet file, OrderRev:

```

TABLE FILE CENTORD
1. HEADING
1. " "
1. "C e n t u r y C o r p o r a t i o n"
1. " "
1. "Order Revenue - 2001 Q3"
1. " "
1. "page <TABPAGENO"
1. " "
2. SUM ORDER_DATE/MtDY ORDER_NUM LINEPRICE AS 'Order,Total:'
   BY LOWEST 9 ORDER_DATE NOPRINT
   WHERE (ORDER_DATE GE '2000/10/01') AND (ORDER_DATE LE '2000/12/31');
3. ON TABLE SET SQUEEZE ON
4. ON TABLE SET STYLE SHEET OrderRev
   ON TABLE HOLD FORMAT PDF
END

```

OrderRev Style Sheet

```

5. TYPE=Report, GRID=Off, UNITS=Inches, TOPGAP=0.06, BOTTOMGAP=0.06, $
6. TYPE=Data, FONT='Times', $
7. TYPE=Data, BACKCOLOR=Aqua, COLOR=Navy,
7.     WHEN=LinePrice GT 500000, $
7. TYPE=Data, COLUMN=LINEPRICE, BACKCOLOR=Aqua, COLOR=Navy, STYLE=Bold,
7.     WHEN=LinePrice GT 500000, $
8. TYPE=Title, FONT='Helvetica', $
9. TYPE=Heading, FONT='Helvetica', STYLE=Bold, SIZE=14, JUSTIFY=Center,
9.     BACKCOLOR=Dark Turquoise, COLOR=White, $
9. TYPE=Heading, LINE=6, BACKCOLOR=White, COLOR=Dark Turquoise, $
9. TYPE=Heading, LINE=7, BACKCOLOR=White, $

```

1. Adds a page heading to the report.
2. Reformats the order date from (for example) 2001/10/03 to Oct. 3, 01.
3. Aligns the heading with the report(tm)s margins instead of the page(tm)s margins.
4. Identifies a StyleSheet file to format the report.
5. Increases spacing between report lines.
6. Uses a proportional serif font for the report(tm)s data.
7. Highlights each order that totals more than \$500,000 by applying a navy font and an aqua background, and by bolding the order total.

8. Uses a proportional sans serif font for the report(tm)s column titles.
9. Formats the report(tm)s heading by centering it, applying a larger sans serif font, coloring most of it with a dark turquoise background and white lettering, and applying the inverse coloring to the page number (the sixth line of the heading).

This is only a summary of what these formatting instructions do; you can find complete explanations in the topics that describe each formatting feature.

The formatting logic that you apply to your own reports may be briefer or more extensive than this example, depending on the report and on what formatting you choose to apply.

Choosing a Type of Style Sheet

You can choose between two types of style sheets to format a report:

- **FOCUS StyleSheets** (often abbreviated to *StyleSheets*), the native FOCUS StyleSheet language. These provide you with the flexibility to format reports in many display formats, including HTML, PDF, Excel 2000, and PostScript. You can choose between saving the StyleSheet as a separate file, which you can assign to multiple reports, or saving it within one report request.

If you are generating a report in HTML format, you can boost its performance, and increase the number of formatting options available to it, by having the FOCUS StyleSheet dynamically generate an internal cascading style sheet (CSS). (CSS is the standard style sheet language designed for HTML documents; the *internal* CSS generated by FOCUS is internal to the report output, instead of being saved as a separate file.)

- **External cascading style sheets**, the standard style sheet language designed for HTML documents. You can apply an external cascading style sheet to any FOCUS report in HTML format. (An *external* cascading style sheet is one that is saved as a separate file, instead of within the document it formats, and so is external to the document.)

How do you choose between the two types of style sheets? Consider choosing:

- **A FOCUS StyleSheet** if you want to display a report in different display formats, such as PDF and Excel 2000. FOCUS StyleSheets support many kinds of display formats, but cascading style sheets work for reports in HTML format only.
- **An external cascading style sheet** for any of the following reasons:

- Your enterprise already uses cascading style sheets to format HTML documents, and it wants reports to conform to these same presentation guidelines.
- You want to apply the same formatting to other kinds of HTML documents in your enterprise.

Choosing an Output Format

You can choose from several different formats when you create a styled report. Some formats are designed to be used with specific applications; in order to be used with those applications, they must be transferred to a PC using FTP. For example, you can choose:

- **HTML format.** You can display your report as an HTML page, which is optimized for display in a Web browser. HTML supports most style sheet options, especially when used with an internal cascading style sheet. An HTML report opens in your Web browser.



Note: SET STYLMODE=FIXED turns off your browser HTML formatting for that report. The resulting report appears in a fixed font without colors and other Web capabilities.

- **Print format-PDF** (the Adobe® Acrobat® Portable Document Format) and **PostScript (PS)**.

You can display your report as a PDF document, which is useful when you want the report to look the same whether displayed on screen or in print. PDF (Adobe Acrobat's Portable Document Format) is most often used to distribute and share electronic documents using the web. It is especially useful if you want a report to maintain its presentation and layout regardless of a user's browser or printer type. PDF prints and displays a document consistently, regardless of the application software, hardware, and operating system used to create or display the document. The report opens in Adobe® Acrobat® or Acrobat Reader. To display a PDF report, a computer must have Adobe Acrobat Reader installed. For free downloads of Acrobat Reader, go to <http://www.adobe.com>.

Limit: Adobe Acrobat's PDF format limits the number of pages, hyperlinks, and images in a document. For information about what limits this creates for a FOCUS report in PDF format, see [Saving and Reusing Your Report Output](#).

You can display your report as a PostScript (PS) document, which is a print-oriented

page description language most often used to send a report directly to a printer. While used less frequently as an online display format, you can display PS report output on your monitor before printing it.

To display rather than print a PostScript report, a computer must have a third-party PostScript application installed, such as GSview (a graphical interface for Ghostscript).

If you are sending a PS report to a printer, you can select the size of the paper on which to print the output. The PostScript code that is generated works on PS printers that support Language Level 2 or above. It is ignored, without harmful effects, on Level 1 printers.

You can also select page orientation and choose among a wide range of paper sizes and combine several reports into one. PDF and PostScript reports require font metric files and font map files to be accessible to FOCUS. FOCUS comes with a set of basic fonts, and you can add other fonts as needed. For details on working with PDF and PostScript reports, see [Using Print Display Formats: PDF, PS](#).

- **Spreadsheet formats.** You can display your report as an Excel 2000 or 97 spreadsheet, where you can work with the data in Excel. You can create Excel 2000 HTML-based format (with variations for Excel 2000 PivotTable and Excel 2000 FORMULA), or Excel 97 HTML-based format. Note that Excel 97 format produces the same report output as HTML format. It is useful if you want your Web browser to open the file in Excel rather than display it as an HTML page. These formats supply the following tools:
 - **Excel 2007 and higher Worksheet (format XLSX).** The XLSX format supports most StyleSheet attributes, allowing for full report formatting. The computer on which the report is being displayed must have Microsoft Excel 2007 or higher installed. You must also have the WebFOCUS Client installed and use the SET EXCELSERVURL to point to the location of the Client, as described in [Using Excel Display Formats: XLSX, EXL2K, EXL97](#).
 - **Excel 2000 Worksheet (format EXL2K).** The Excel 2000 format supports most StyleSheet attributes, allowing for full report formatting. The computer on which the report is being displayed must have Microsoft Excel 2000 or higher installed.
- In addition, FOCUS supports two Excel 2000 variations: EXL2K FORMULA and EXL2K PIVOT. When either of these formats is specified, additional processing is done. For information on using these options, see [Using Excel Display Formats: XLSX, EXL2K, EXL97](#).

- **Excel 2000 FORMULA (EXL2K FORMULA).** If you display a report using the format variation EXL2K FORMULA, the resulting spreadsheet will contain Excel formulas that calculate and display the results of any type of summed information (such as column totals, row totals, and sub-totals).
- **Excel 2000 PivotTable (format EXL2K PIVOT).** Generates a fully functional Excel PivotTable, an Excel tool for analyzing complex data.
- **Excel 97 spreadsheet (format EXL97).** Excel 97 is an HTML-based display format that opens in Excel 97 or higher and supports report formatting. The computer on which the report is being displayed must have Microsoft Excel 97 or higher installed.

Sample FOCUS StyleSheet Files

Several sample StyleSheet files are shipped with FOCUS. You can apply any of these sample StyleSheets directly to a report, or you can use them as templates to create your own customized StyleSheets. If you use them as templates, be sure to make a copy of the original file and edit the copy, leaving the original unchanged.

Following are the sample StyleSheets available. They are members in a data set allocated to ddname FOCSTYLE:

FOCUS StyleSheet	File/Member Name
Elegant Look	CLASSIC
Formal Corporate Presentation	CORPORAT
Gold and brown backgrounds for selected components	BOYSCOUT
Orange and yellow backgrounds for selected components	CITRUS
Bold headings	DEFLT
Gray backgrounds for selected components	DEFLT1

FOCUS StyleSheet	File/Member Name
Dark pink and gray backgrounds for selected components	DEFLT2
Blue and gray backgrounds for selected components	DEFLT3
Blue and gray backgrounds for selected components	DEFLTBLU
Alternating row shades.	ENDEFLT
Light pink backgrounds for selected components	ELEPHANT
Purple and fuchsia backgrounds for selected components	FUCHSIA
Brown and pink backgrounds for selected components	MARBLE
Yellow and purple backgrounds for selected components	OLIVE
Dark gray and green backgrounds for selected components	PAPER
Dark blue and light gray backgrounds for selected components	SALES
Light yellow and blue backgrounds for selected components	SLATE
Sporty look with sports team colors such as orange and blue	SPORTS
Light green and gray backgrounds for selected components	TEAL
Red, White, and Blue	USA
Brown and yellow backgrounds for selected components	WOOD

Styling Reports With StyleSheets

To use a StyleSheet, follow these steps:

1. Decide which StyleSheet to use. If one already exists with the formatting you need, go on to the next step. FOCUS comes with default styles that you can use if you want the whole report printed with the same default format. If you want to customize certain formats in your report, create a StyleSheet that describes those formats.

i Note: You can change some formatting features, such as the page parameters, with a SET command without creating a StyleSheet.

2. Activate the StyleSheet you have chosen, or create a StyleSheet in a report request.
3. Create a PostScript, HTML, PDF (Acrobat's Portable Document Format), Excel 2000, or Excel 97 file that contains the formatted report.

Use FTP to transfer this file to Windows, if necessary.

4. Print the report on a PostScript printer or open it in the appropriate application. This step is highly dependent on the equipment and software at your site. See your system administrator for instructions.

What Is a StyleSheet?

A StyleSheet is a group of declarations, in a text file or in a report request, that describe how you want your report to look. These declarations:

- Identify a report component.
- Describe the desired characteristics of that component.

You can create a StyleSheet using any text editor, including TED, the FOCUS text editor.

FOCUS uses the same default style for all report components if you do not create a StyleSheet.

With a StyleSheet, you only have to define the styles of those components to be displayed differently from the default style. Any component not specifically formatted in your StyleSheet either uses the default style or inherits a style from a higher-level component. Inheritance is discussed in [FOCUS StyleSheet Attribute Inheritance](#).

When you create a styled report, your page layout differs from a standard FOCUS report. This variation is a function of the page layout parameters FOCUS uses for the two kinds of reports:

- For unstyled reports, FOCUS uses the parameters LINES, PAPER, PANEL, and WIDTH to define the page layout.
- For styled reports, FOCUS uses the parameters PAGESIZE, ORIENTATION, UNITS, TOPMARGIN, BOTTOMMARGIN, LEFTMARGIN, RIGHTMARGIN, and SQUEEZE. Any of these parameters that you do not specifically set-either in a report request, in a StyleSheet, or with a SET command-inherits default values.

What Is a Style?

A style is a description of the physical characteristics of a report component; it consists of four basic attributes:

- A font (typeface) such as Helvetica, Courier, or Times.
- A size for the font such as 12-point or 14-point.
- A text style or combination of text styles such as bold, italic, or bold+italic.
- A color.

You can also define such attributes as background colors, grids, borders, and images in a StyleSheet declaration.

Reproducing StyleSheet Examples

The sample reports use the default page size specification for PDF and PS reports, LETTER, which represents 8.5 x 11 inch pages. They have been scaled down to accommodate the size of this manual.

If the fonts you have on your system do not include the ones used in the examples, substitute suitable and available fonts before you run the examples.

Comparison of Reports With and Without StyleSheets

In a non-styled FOCUS report request, you can set values for the maximum number of lines on the output page (LINES), the number of lines on the printed page (PAPER), and the maximum number of characters in a report panel (PANEL). FOCUS then uses the typeface and size defined by your printer setup for all data in the report.

In a styled report, you can specify measurement units such as inches or points, and you can control column width or spacing. You can also change typefaces, type size, and type style for any part of the report.

In a PostScript or PDF report, you can also set margins on the top, bottom and sides of the report, and you can set the page size for letters, envelopes, and many other types of paper. The following table compares your options with and without StyleSheets:

	With StyleSheets	Without StyleSheets
Text font	You can use different font sizes and fonts. You can selectively apply text styles such as bold or italic.	FOCUS uses the default font specified in your printer setup for the entire report.
Colors	You can select a color for the text or background.	The ink and paper in your printer determine the colors in your report.
Individual components	You can assign different styles to individual report components.	FOCUS uses a single style for the entire report.
Conditional styling	You can apply different styles to the same component based on report values.	Report format does not change with changes in report values.
Column widths	You can have column widths based on the column content, the field format specified in the Master File,	FOCUS bases column widths on the column title or the field format specified either in the Master File or the

	With StyleSheets	Without StyleSheets
	or specify a width.	report request.
Column placement	You can specify the starting position of individual columns and arrange columns in any order regardless of the sequence established in the report request. In addition, you can indicate how much space to leave before and after individual columns.	You can specify the starting position of individual columns in the report request.
Page size	You can select from a wide range of page sizes for PostScript and PDF reports.	You can specify the number of lines per page within the limits of your printer setup.
Page orientation	You can select either portrait or landscape for PostScript, PDF, and EXL2K reports.	FOCUS uses the default orientation specified in your printer setup.
Page margins	You can specify the top, bottom, left, and right margins, measured in inches, centimeters, or points for PostScript and PDF reports.	FOCUS uses the default page margins specified in your printer setup.
Justification	You can justify individual report components.	You can justify column titles.

Creating a StyleSheet

There are two ways to create a StyleSheet:

- You can create a StyleSheet file in a report request. This is useful when you are applying that set of styles to only one report. See [Create a StyleSheet in a Report](#)

Request.

- You can create a separate StyleSheet file. In order to use a StyleSheet file, you must activate it. This option is useful when you want to create a StyleSheet template that you can apply to any report. In addition, you can create a StyleSheet on one platform and then port it to, and run it on, other platforms. See [Activate an Existing StyleSheet File](#).

i Note: You can also include a StyleSheet file in another StyleSheet. This enables you to apply the styles in the included StyleSheet file, but override specific attributes. For information, see [Include a StyleSheet File in Another StyleSheet](#).

You can take advantage of most StyleSheet options without ever having to create a StyleSheet.

You can select a StyleSheet, page size, orientation, and margins at the FOCUS command level (if you want to apply them to your entire FOCUS session), or in a report request (if you want to apply them to one report).

You need to create a StyleSheet file if you wish to:

- Style report components individually.
- Apply different styles to the same component based on report values.

Create a StyleSheet in a Report Request

```
ON TABLE SET STYLE *  
.  
.  
.  
ENDSTYLE
```

where:

STYLE *

Indicates the beginning of an inline StyleSheet.

ENDSTYLE

Indicates the end of an inline StyleSheet.

i Note: You can omit the keyword `ENDSTYLE`, but only if it is immediately followed by the keyword `END` in the report request.

Creating a StyleSheet Within a Report Request

In the following report request, the `StyleSheet` syntax appears in bold.

```
TABLE FILE EMPLOYEE
PRINT EMP_ID FIRST_NAME LAST_NAME
BY DEPARTMENT
ON TABLE HOLD FORMAT PS
ON TABLE SET STYLE *
TYPE=REPORT, FONT=TIMES, SIZE=10, $
TYPE=REPORT, COLUMN=EMP_ID, RIGHTGAP=1, $
ENDSTYLE
END
```

The request produces the following report, in which the font for the entire report and the amount of space to the right of the `EMP_ID` field have been changed:

PAGE 1			
<u>DEPARTMENT</u>	<u>EMP_ID</u>	<u>FIRST_NAME</u>	<u>LAST_NAME</u>
MIS	112847612	MARY	SMITH
	117593129	DIANE	JONES
	219984371	JOHN	MCCOY
	326179357	ROSEMARIE	BLACKWOOD
	543729165	MARY	GREENSPAN
PRODUCTION	818692173	BARBARA	CROSS
	071382660	ALFRED	STEVENS
	119265415	RICHARD	SMITH
	119329144	JOHN	BANNING
	123764317	JOAN	IRVING
	126724188	ANTHONY	ROMANS
	451123478	ROGER	MCKNIGHT

Activate an Existing StyleSheet File

The syntax for the `SET` command is:

```
SET STYLE[SHEET] = styoption
```

and the syntax in a report request is

```
TABLE FILE file
request
ON TABLE SET STYLE styoption
END
```

where:

styoption

Is one of the following options:

ON uses default styles. This is the default setting. With this setting in effect, FOCUS uses the page layout settings for UNITS, TOPMARGIN, BOTTOMMARGIN, LEFTMARGIN, RIGHTMARGIN, PAGESIZE, ORIENTATION, and SQUEEZE, and ignores the settings for LINES, PAPER, PANEL, and WIDTH. Each display format has its own set of defaults. For example, HTML defaults to a proportional font, while PDF defaults to a monospace font.

OFF uses default styles. In this case, FOCUS uses the settings for LINES, PAPER, PANEL, and WIDTH, and ignores the settings for UNITS, BOTTOMMARGIN, LEFTMARGIN, RIGHTMARGIN, TOPMARGIN, PAGESIZE, ORIENTATION, and SQUEEZE. The report is printed in fixed-width Courier typeface with .250-inch margins. You can use this setting to print traditional-looking FOCUS reports on PostScript printers.

i Note: To disable StyleSheets entirely so that no StyleSheet is activated, use the ONLINE-FMT setting discussed in [Creating a Styled Report](#).

stysheet is the one- to eight-character name of a StyleSheet file. This setting activates the named StyleSheet. FOCUS uses the page layout settings for UNITS, TOPMARGIN, BOTTOMMARGIN, LEFTMARGIN, RIGHTMARGIN, PAGESIZE, ORIENTATION, and SQUEEZE, and ignores the settings for LINES, PAPER, PANEL, and WIDTH.

Include a StyleSheet File in Another StyleSheet

```
INCLUDE=stysheet,$
```

where:

stysheet

Is the name of the StyleSheet file in the list of data sets allocated to DDNAME FOCSTYLE.

StyleSheet declarations are applied in the order in which they are found in the StyleSheet. Therefore, if you want to include a StyleSheet file and then override some of the attributes within it, place the INCLUDE statement first, then the declarations that override specific attributes below it.

Including a StyleSheet File in Another StyleSheet

The following request includes the ENDEFILT StyleSheet in the inline report StyleSheet and overrides the heading style to be bold and italic.

```
HEADING CENTER
"TEST OF STYLESHEET WITH INCLUDE"
" "
SUM DOLLARS BUDDOLLARS
BY CATEGORY
ON TABLE HOLD AS STYLE2 FORMAT HTML
ON TABLE SET STYLE *
INCLUDE=ENDEFILT,$
TYPE=HEADING, STYLE = BOLD+italic,$
END
```

The output is shown in the following image.

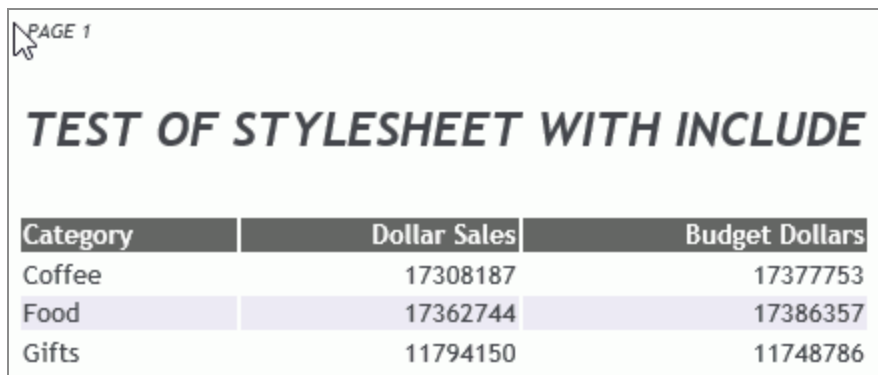

PAGE 1

TEST OF STYLESHEET WITH INCLUDE

Category	Dollar Sales	Budget Dollars
Coffee	17308187	17377753
Food	17362744	17386357
Gifts	11794150	11748786

StyleSheet Syntax

A StyleSheet consists of a series of declarations that describe how your report will look. Each declaration:

- Identifies a report component or subcomponent.
- Describes the formatting to apply to that component.
- Optionally, if the component is a heading, footing, or column, specifies a position on the page for the component and a justification.
- Optionally, specifies the distance between columns, column sequence, and column width.
- Optionally, specifies a condition that must be true in order to apply the style. This technique is called conditional styling.

In your StyleSheet, include declarations for only those components whose format to change. Within each declaration, include only those formatting attributes to change.

Each declaration in a StyleSheet consists of attribute=value pairs separated by commas, and terminated with a comma and dollar sign (,\$). The attributes that select a component or subcomponent must come first in each declaration. You can specify all other attributes in any order. The syntax is:

```
TYPE=value1, attribute2=value2, ... , $
```

i Note:

- You can use uppercase, lowercase, or mixed-case in the StyleSheet file.
- Page layout parameters automatically apply to the whole report. Therefore, declarations that set page parameters do not require a TYPE attribute. For example, the following declarations are equivalent:

```
TYPE=REPORT, ORIENTATION=LANDSCAPE , $
ORIENTATION=LANDSCAPE, $
```

See [Styling the Page Layout](#) for a complete description of page parameters.

- Each declaration must begin on a new line.
- A declaration can use more than one line. The terminating dollar sign indicates where the declaration ends.
- You can describe a single report element in more than one declaration.
- You can include blank spaces between the attributes, values, equal signs (=), commas, and dollar sign. You can also include blank lines. FOCUS can interpret declarations with or without blank spaces or lines.
- You can include comments, either on a declaration line after the terminating dollar sign, or on a separate comment line that begins with a dollar sign.

The attributes in the StyleSheet file identify report components, manipulate them, and define styles for formatting them.

Improving FOCUS StyleSheet Readability

There are many ways to structure your StyleSheet declarations in order to make the StyleSheet easy to read. You can do any one, or a combination, of the following:

- Begin a declaration in any column using blank spaces or tabs.
- Include blank lines between declarations.
- Create declarations in all uppercase, all lowercase, or mixed case.
- Use more than one declaration to format a single report component.

- Include blank spaces or tabs in between the attribute, equal sign (=), value, comma, and dollar sign (\$).
- Split a single declaration across a line. The declaration will continue to be processed until the dollar sign terminates it. For example, you can split a declaration like this:

```
TYPE=HEADING, FONT=ARIAL,
SIZE=14, STYLE=BOLD, $
```

- Split an *attribute=value* pair across a line. Use the backslash (\) character as continuation syntax at the end of the first line if you are splitting an attribute or value in a declaration across a line. For example:

```
TYPE=TITLE, COLUMN=N2, STY\
LE=BOLD+ITALIC, COLOR=BLUE, $
```

Adding a Comment to a FOCUS StyleSheet

You can add comments to a StyleSheet to give context to a declaration. Comments do not affect StyleSheet behavior.

You can add a comment:

- **On a declaration line.** Add the desired text after the dollar sign (\$). For example,

```
TYPE=HEADING, STYLE=BOLD, COLOR=BLUE, SIZE=14, $ Sample comment
```

- **On its own line.** Begin the line with either a dollar sign (\$), or a hyphen and an asterisk (-*), followed by the desired text. For example,

```
-* This is a sample comment
$ This is another sample comment
```

i Note: You can add comments anywhere in your request, not only in StyleSheets.

Checking StyleSheet Syntax

You can check the syntax of a StyleSheet from the FOCUS prompt with the CHECK STYLE command.

Check StyleSheet Syntax

```
CHECK STYLE filename
```

where:

filename

Is the name of the StyleSheet file.

FOCUS reports any syntax errors in the StyleSheet file. It does not verify whether the specified fonts are available or whether the font names are spelled correctly.

Creating a Styled Report

In order to create a report that was formatted using a StyleSheet, you must generate an output file containing the formatted report.

Create a Styled Report

Create a HOLD or SAVE file containing the report output in PostScript format. You can issue the HOLD or SAVE command either from the FOCUS command line or in a TABLE request. The syntax is

```
[ON TABLE] {HOLD|SAVE} FORMAT format [AS filename]
```

where:

filename

Assigns a 1- to 8-character file name or ddname to the report output. The default file name is HOLD.

format

Can be one of the following:

HTML for HTML output.

PDF for PDF output.

PS or POSTSCRIPT for PostScript output.

EXL2K for Excel 2000 output. You can also use EXL2K PIVOT for Excel 2000 output with a pivot table or EXL2K FORMULA for Excel 2000 output with formulas.

EXL97 for Excel 97 output.

When you generate stylized report output that is too wide to fit in the defined print area of a single page, StyleSheet formatting divides the output across multiple pages or panels. The pages are automatically numbered with decimal notation indicating the panel number (1.1, 1.2, and so on).

Styling the Page Layout

In a styled report, FOCUS uses page parameters to format the page layout. These parameters have default values that remain in effect unless you change them.

Selecting Page Size, Orientation, and Color

You can select the page size, page orientation (portrait or landscape), and page color for your report. The default page size is letter (8.5 x 11 inches), but you can select from many other sizes, including legal and envelopes.

In a PostScript report, you can use the SET PSPAGESETUP command to include PostScript code that automatically tells a PostScript printer to set its paper source to the size of paper specified by PAGESIZE.

Page Size, Orientation, and Color Attributes

Attribute	Description	Applies to
PAGESIZE	Sets page size.	PDF PS
ORIENTATION	Sets page orientation.	PDF PS EXL2K
PAGECOLOR	Sets page color.	HTML report with internal cascading style sheet

Set Page Size

This syntax applies to a PDF or PS report.

```
[TYPE=REPORT,] PAGESIZE={size|LETTER}, $
```

where:

TYPE=REPORT

Applies the page size to the entire report. Not required, as it is the default.

size

Is the page size. If printing a report, the value should match the size of the paper. Otherwise, the report may be cropped or printed with extra blank space.

Valid values are:

Value	Description
LETTER	8.5 x 11 inches. This value is the default.
LEGAL	8.5 x 14 inches.
TABLOID	11 x 17 inches.
LEDGER	17 x 11 inches.
C	17 x 22 inches.
D	22 x 34 inches.
E	34 x 44 inches.
STATEMENT	5.5 x 8.5 inches.
EXECUTIVE	7.5 x 10.5 inches.
FOLIO	8.5 x 13 inches.
10x14	10 x 14 inches.

Value	Description
A3	297 x 420 millimeters.
A4	210 x 297 millimeters.
A5	148 x 210 millimeters.
B4	250 x 354 millimeters.
B5	182 x 257 millimeters.
QUARTO	215 x 275 millimeters.
ENVELOPE-9	3.875 x 8.875 inches.
ENVELOPE-10	4.125 x 9.5 inches.
ENVELOPE-11	4.5 x 10.375 inches.
ENVELOPE-12	4.5 x 11 inches.
ENVELOPE-14	5 x 11.5 inches.

Value	Description
ENVELOPE-MONARCH	3.875 x 7.5 inches.
ENVELOPE-PERSONAL	3.625 x 6.5 inches.
ENVELOPE-DL	110 x 220 millimeters.
ENVELOPE-C3	324 x 458 millimeters.
ENVELOPE-C4	229 x 324 millimeters.
ENVELOPE-C5	162 x 229 millimeters.
ENVELOPE-C6	114 x 162 millimeters.
ENVELOPE-C65	114 x 229 millimeters.
ENVELOPE-B4	250 x 353 millimeters.
ENVELOPE-B5	176 x 250 millimeters.
ENVELOPE-B6	176 x 125 millimeters.

Value	Description
ENVELOPE-ITALY	110 x 230 millimeters.
US-STANDARD-FANFOLD	14.875 x 11 inches.
GERMAN-STANDARD-FANFOLD	8.5 x 12 inches.
GERMAN-LEGAL-FANFOLD	8.5 x 13 inches.

Set Page Orientation

This syntax applies to a PDF, PS, or EXL2K report.

```
[TYPE=REPORT, ] ORIENTATION={PORTRAIT | LANDSCAPE}, $
```

where:

TYPE=REPORT

Applies the page orientation to the entire report. Not required, as it is the default value.

PORTRAIT

Displays the report across the narrower dimension of a vertical page, producing a page that is longer than it is wide. PORTRAIT is the default value.

LANDSCAPE

Displays the report across the wider dimension of a horizontal page, producing a page that is wider than it is long.

Control the Paper Source Used by a PostScript Printer

The SET PSPAGESETUP command includes PostScript code that automatically tells a PostScript printer to set its paper source to the size of paper specified by the PAGESIZE parameter

```
SET PSPAGESETUP = {ON|OFF}
```

or

```
ON TABLE SET PSPAGESETUP {ON|OFF}
```

where:

ON

Includes PostScript code that tells a PostScript printer to set its paper source to the size of paper specified by the PAGESIZE parameter.

⚠ Caution: If you send a job to a printer that does not have the requested paper size loaded, the printer may stop and instruct its operator to load the specified paper. To ensure control over your printing, it is best to set paper size in individual requests so that you can load paper as required.

OFF

Does not include code to coordinate the printer's paper source with the PAGESIZE parameter. OFF is the default value.

Set Page Color

This syntax applies to an HTML report with an internal cascading style sheet.

```
[TYPE=REPORT,] ... PAGECOLOR=color, ... , $
```

where:

TYPE=REPORT

Applies the color to the entire report. Not required, as it is the default value.

color

Is a supported color. For a list of supported colors, see [Color Values in a Report](#).

Setting Page Color

This request sets the page color of an HTML report with internal cascading style sheet to silver.

```

SET HTMLCSS = ON
TABLE FILE CENTORD
ON TABLE SUBHEAD
"SELECTED PRODUCT INVENTORY"
SUM QTY_IN_STOCK/D12 BY PROD_NUM BY SNAME BY STATE
WHERE PROD_NUM EQ '1004'
WHERE SNAME EQ 'eMart'
WHERE STATE EQ 'CA'
ON TABLE SET PAGE-NUM OFF
ON TABLE HOLD FORMAT HTML
ON TABLE SET STYLE *
TYPE=REPORT, PAGECOLOR=SILVER, GRID=OFF, $
ENDSTYLE
END

```

The output is:

SELECTED PRODUCT INVENTORY			
<u>Product</u>	<u>Store</u>		<u>Quantity</u>
<u>Number#:</u>	<u>Name:</u>	<u>State:</u>	<u>In Stock:</u>
1004	eMart	CA	689,088

Setting Page Margins

You can set the page margins for your report. This includes the top, bottom, left, and right margins. You can also change the default unit of measurement (inches) to either

centimeters or points. The unit of measurement applies to page margins, column width, and column position.

Page Margin Attributes

Attribute	Description	Applies to
UNITS	<p>Sets unit of measurement.</p> <p>Used when specifying margin size or other page characteristics. If you change the current unit of measurement, the new value is applied to all instances in which unit of measurement is used.</p>	<p>PDF</p> <p>PS</p> <p>HTML report with internal cascading style sheet</p>
TOPMARGIN BOTTOMMARGIN LEFTMARGIN RIGHTMARGIN	<p>Sets size of top, bottom, left, and right margin.</p>	<p>PDF</p> <p>PS</p> <p>HTML report with internal cascading style sheet</p>

Set the Unit of Measurement

This syntax applies to a PDF, PS, or HTML report with internal cascading style sheet.

To set a unit of measurement:

- In a StyleSheet, add the following attribute:

```
UNITS = units
```

- Outside of a report request, use:

```
SET UNITS = units
```

- Within a report request, use

```
ON TABLE SET UNITS units
```

where:

units

Is the unit of measure. Values can be:

INCHES which specifies the unit of measure as inches. This is the default value.

CM which specifies the unit of measure as centimeters.

PTS which specifies the unit of measure as points. Points is a common measurement scale for typefaces.

Set Margin Size

This syntax applies to a PDF, PS, or HTML report with an internal cascading style sheet.

```
[TYPE=REPORT,] [TOPMARGIN={value|.25},] [BOTTOMMARGIN={value|.25},]
[LEFTMARGIN={value|.25},] [RIGHTMARGIN={value|.25},] $
```

where:

TYPE=REPORT

Applies the margin size to the entire report. Not required, as it is the default.

TOPMARGIN

Sets the top boundary of the report content.

BOTTOMMARGIN

Sets the bottom boundary of the report content.

LEFTMARGIN

Sets the left boundary of the report content.

RIGHTMARGIN

Sets the right boundary of the report content.

value

Is the size of the specified margin. The report content appears inside the margin. If printing a report, specify a value compatible with the printer's print area. For example, if the print area has 0.25 inch margins all around, set the margins to 0.25 inches or larger.

The default value for all margins is 0.25 inches.

Displaying Current Settings: The ? SET STYLE Query

Use the ? SET STYLE query to display the current settings for the STYLESHEET parameter and all page parameters.

Display Current Settings

The syntax is:

```
? STYLE
```

For example:

```
? style
ONLINE-FMT      STANDARD
OFFLINE-FMT     STANDARD

STYLESHEET      ON
SQUEEZE         OFF
PAGESIZE        Letter
ORIENTATION     PORTRAIT
UNITS           INCHES
LABELPROMPT     OFF
LEFTMARGIN      .250
RIGHTMARGIN     .250
```

```

TOPMARGIN      .250
BOTTOMMARGIN  .250
STYLEMODE     FULL
TARGETFRAME
FOCEXURL
BASEURL

```



Note: OFFLINE-FMT is not currently supported. ONLINE-FMT and FOCEXURL apply to WebFOCUS.

Specifying Font Format in a Report

Using StyleSheet attributes, you can enhance the appearance of a report by specifying the font, its size, and its color. You can also specify the background color of the report. Specifications for background color or font format can be made for a report as a whole, or for headings, footings, and columns designated individually.

Specify Font Size in a Report

To specify a font size, use the following syntax within a StyleSheet.

```
TYPE = type, [subtype,] SIZE=pts, $
```

where:

type

Is the report component you wish to affect, such as REPORT, HEADING, or TITLE.

subtype

Is any additional attribute, such as COLUMN, ACROSS, or ITEM, that is needed to identify the report component that you are formatting. See [Identifying Report Components](#) for more information about how to specify different report components.

pts

Is the size of the font in points. The default value is 10, which corresponds to the HTML default font size 3. For more information on the correlation between point size and HTML font size, see [Usage Notes for Changing Font Size](#).

Usage Notes for Changing Font Size

Point size is fixed, except in an HTML report. Relative point size uses a different scale than HTML font size. The following table lists the point size and corresponding HTML font size:

Size in Points	Corresponding HTML Font Size
8 or smaller	1
9	2
<u>10</u>	<u>3</u>
11	4
12	5
13	6
14 or larger	7

Specify Bold or Italic Font Style in a Report

To specify a font style, use the following syntax within a StyleSheet.

```
TYPE=type, [subtype,] STYLE=[+|-]txtsty[{|+|-}txtsty], $
```

where:

type

Is the report component you wish to affect, such as REPORT, HEADING, or TITLE.

subtype

Is any additional attribute, such as COLUMN, ACROSS, or ITEM, that is needed to identify the report component that you are formatting. See [Identifying Report Components](#) for more information about how to specify different report components.

txtsty

Is one of the following values: NORMAL, BOLD, ITALIC. The default value is NORMAL.

+

Enables you to specify a combination of font styles. You can add additional font styles to an attribute that already has one or more font styles applied to it.

-

Enables you to remove a font style from an attribute.

Adding and Removing Inherited Font Style in a Report

In the following report request, the font styles bold and italic are specified for the entire report. The inherited italics are removed from the heading, and both styles are removed from the column titles.

The report request is:

```
TABLE FILE GGSales
HEADING
"Sales Report by Category"
SUM UNITS DOLLARS BY CATEGORY
ON TABLE HOLD FORMAT HTML
ON TABLE SET STYLE *
TYPE=REPORT, STYLE=BOLD+ITALIC, $
TYPE=HEADING, STYLE=-ITALIC, $
TYPE=TITLE, STYLE=-BOLD-ITALIC, $
TYPE=REPORT, GRID=OFF, $
ENDSTYLE
END
```

The output is:

Sales Report by Category		
<u>Category</u>	<u>Unit Sales</u>	<u>Dollar Sales</u>
<i>Coffee</i>	<i>1376266</i>	<i>17231465</i>
<i>Food</i>	<i>1384845</i>	<i>17229344</i>
<i>Gifts</i>	<i>927880</i>	<i>11695502</i>

Specify Font Color in a Report

To specify a color for the font of a report or a report component, use the following syntax within a StyleSheet.

```
TYPE=type, [subtype,] COLOR={color|RGB(r g b)},$
```

where:

type

Is the report component you wish to affect, such as REPORT, HEADING, or TITLE.

subtype

Is any additional attribute, such as COLUMN, ACROSS, or ITEM, that is needed to identify the report component that you are formatting. See [Identifying Report Components](#) for more information about how to specify different report components.

color

Is one of the preset color values such as GREY or GOLD. If the display or output device does not support colors, it substitutes shades of gray. The default value is BLACK. For a complete list of available color values, see [Color Values in a Report](#).

RGB

Specifies the font color using a mixture of red, green, and blue.

(r g b)

Is the desired intensity of red, green, and blue, respectively. The values are on a scale of 0 to 255, where 0 is the least intense and 255 is the most intense. Note that using the three color components in equal intensities results in shades of gray.

Specify Background Color in a Report

Use the following StyleSheet syntax to specify a color for the background of a report.

Note that when using BACKCOLOR in a PDF report, extra space is added to the top, bottom, right, and left of each cell of data in the report. This is for readability and to prevent truncation.

```
TYPE=type, [subtype,] BACKCOLOR={color|RGB(r g b)}}, $
```

where:

type

Is the report component you wish to affect, such as REPORT, HEADING, or TITLE.

subtype

Is any additional attribute, such as COLUMN, ACROSS, or ITEM, that is needed to identify the report component that you are formatting. See [Color Values in a Report](#) for more information about how to specify different report components.

color

Is the background color, which fills the space of the specified report component. The default value is NONE. If you are creating a report in HTML format, background colors will only appear in Web browsers that support them. Netscape Navigator 3.0 and higher and Microsoft Internet Explorer 3.0 and higher support background colors.

RGB

Specifies the font color using a mixture of red, green, and blue.

(r g b)

Is the desired intensity of red, green, and blue, respectively. The values are on a scale of 0 to 255, where 0 is the least intense and 255 is the most intense. Note that using the

three color components in equal intensities results in shades of gray.

Color Values in a Report

The following chart lists all available color values that can be utilized with the syntax.

`COLOR=color`, `BACKCOLOR=color`, or `PAGECOLOR=color`

where *color* is one of the following values:

AQUA (CYAN)	MEDIUM FOREST GREEN (OLIVE)
AQUAMARINE	MEDIUM GOLDENROD
BLACK	MEDIUM ORCHID
BLUE VIOLET	MEDIUM SLATE BLUE
CADET BLUE	MEDIUM SPRING GREEN
CORAL	MEDIUM TURQUOISE
CORNFLOWER BLUE	MEDIUM VIOLET RED
CYAN (AQUA)	MIDNIGHT BLUE

DARK GREEN	NAVY (NAVY BLUE)
DARK OLIVE GREEN	OLIVE (MEDIUM FOREST GREEN)
DARK ORCHID	ORANGE
DARK SLATE BLUE (PURPLE)	ORANGE RED
DARK SLATE GREY	ORCHID
DARK TURQUOISE	PALE GREEN
DIM GREY (GRAY, GREY)	PINK
FIREBRICK	PLUM
FOREST GREEN (GREEN)	PURPLE (DARK SLATE BLUE)
FUCHSIA (MAGENTA)	RED
GOLD	SALMON

GOLDENROD	SEA GREEN
GRAY (DIM GREY, GREY)	SIENNA
GREEN (FOREST GREEN)	SILVER
GREEN YELLOW	SKY BLUE
GREY (DIM GREY, GRAY)	SLATE BLUE
INDIAN RED	STEEL BLUE (TEAL)
KHAKI	TAN
LIGHT BLUE	TEAL (STEEL BLUE)
LIGHT GREY	THISTLE
LIGHT STEEL BLUE	TURQUOISE
LIME	VIOLET

LIME GREEN	VIOLET RED
MAGENTA (FUCHSIA)	WHEAT
MAROON	WHITE
MEDIUM AQUAMARINE	YELLOW
MEDIUM BLUE	YELLOW GREEN

Note that some colors may not appear as specified in the Excel formats, because FOCUS has no control over how Excel renders colors.

Specifying Fonts for Reports

You can specify your own fonts in a report by using the FONT attribute in a StyleSheet. If you are specifying a font for an HTML report, the user's Web browser must support the font. If the Web browser does not support the font, it reverts to its default behavior of using the default proportional font.

Specify Fonts in a Report

To specify a font for your report, use the following syntax within a StyleSheet.

```
TYPE=type, [subtype,] FONT='font[,font]',$
```

where:

type

Is the report component you wish to affect, such as REPORT, HEADING, or TITLE.

subtype

Is any additional attribute, such as COLUMN, ACROSS, or ITEM, that is needed to identify the report component that you are formatting. See [Identifying Report Components](#) for more information about how to specify different report components.

font

Is the name of the font. You must enclose the value in single quotes. If you are creating an HTML report, you can specify more than one font within the single quotes to accommodate more than one browser.

i **Note:** In an HTML report, specifying different fonts for several different report components significantly increases the size of the source code.

Specifying Multiple Fonts in an HTML Report

To control how a report looks on more than one platform, you can specify both a common Windows font and a common UNIX font in a request. The Web browser searches for the first font in the list. If the browser does not find this font, it searches for the next one in the list. If none of the fonts are identified, the browser uses the default proportional font.

In this example, the Web browser first searches for the Arial font. If the browser does not find Arial, it searches for the Helvetica font. If neither font is identified, the browser uses the default proportional font.

```
TYPE=REPORT, FONT='ARIAL,HELVETICA', $
```

Specify the Default Browser Fonts for HTML Reports

A browser assigns specific fonts as the default proportional and default monospace fonts. To specify a default browser font for an HTML report, you use the reserved names,

DEFAULT-PROPORTIONAL and DEFAULT-FIXED in the StyleSheet of your report. The browser displays the report accordingly.

To select the default fixed or proportional font of the browser, use the following syntax. Note that you must specify TYPE to indicate which report components you wish to affect.

```
FONT={DEFAULT-PROPORTIONAL|DEFAULT-FIXED}, $
```

where:

DEFAULT-PROPORTIONAL

Specifies the default proportional font of the Web browser.

DEFAULT-FIXED

Specifies the default monospace font of the Web browser.

Specifying Default Browser Fonts

In this example, the Web browser uses the default monospace font for the entire report except the report heading and column headings. For these headings, the Web browser uses the default proportional font.

```
TABLE FILE GGSales
HEADING
"Sales Report"
ON TABLE HOLD FORMAT HTML
SUM UNITS DOLLARS BY CATEGORY BY PRODUCT
ON TABLE SET STYLE *
TYPE=REPORT, FONT=DEFAULT-FIXED, $
TYPE=TITLE, FONT=DEFAULT-PROPORTIONAL, $
TYPE=HEADING, FONT=DEFAULT-PROPORTIONAL, $
TYPE=REPORT, GRID=OFF, $
ENDSTYLE
END
```

The output is:

Sales Report			
<u>Category</u>	<u>Product</u>	<u>Unit Sales</u>	<u>Dollar Sales</u>
Coffee	Capuccino	189217	2381600
	Espresso	308986	3906243
	Latte	878063	10943622
Food	Biscotti	421377	5263328
	Croissant	630054	7749902
	Scone	333414	4216114
Gifts	Coffee Grinder	186534	2337567
	Coffee Pot	190695	2449585
	Mug	360570	4522521
	Thermos	190081	2385829

Identifying Report Components

The basic concept behind StyleSheets is that a report consists of several components, each of which has a specific name. A StyleSheet file consists of style declarations for those components whose styles you want to change, along with the formatting that you want to apply to those components. Any component that you do not specifically format in your StyleSheet either retains the default style or inherits a style from a higher level component. Inheritance is discussed in [FOCUS StyleSheet Attribute Inheritance](#).

In a StyleSheet, you identify a report component with the TYPE attribute. The following chart lists all report components:

TYPE	Report Component
REPORT	The entire report. See Identifying an Entire Report, Column, or Row .
PAGENUM	Default page numbers. See Identifying a Page Number, Underline, or Skipped Line .

TYPE	Report Component
	<p>Note: Styles created for page number lines do not apply to page numbers created by the TABPAGENO variable in TABLE requests. You can format TABPAGENO page numbers by defining a style for the heading or footing that contains it.</p>
TABHEADING	A heading on the first page of a report, generated by ON TABLE SUBHEAD. See Identifying a Heading or Footing .
TABFOOTING	A footing on or after the last page of a report, generated by ON TABLE SUBFOOT. See Identifying a Heading or Footing .
HEADING	Headings at the top of each report page. See Identifying a Heading or Footing .
FOOTING	Footings at the bottom of each report page. See Identifying a Heading or Footing .
SUBHEAD	Headings before a particular sort field, generated by ON sortfield SUBHEAD. See Identifying a Heading or Footing .
SUBFOOT	Footings after a particular sort field, generated by ON sortfield SUBFOOT. See Identifying a Heading or Footing .
DATA	Report data. See Identifying Data .
TITLE	Column titles. See Identifying a Column or Row Title .
ACROSSTITLE	ACROSS field names (that is, field names used in ACROSS phrases). See Identifying a Heading, Footing, Title, or FML Free Text

TYPE	Report Component
ACROSSVALUE	ACROSS field values (that is, values of the ACROSS field). These values become column titles in the report. See Identifying Report Components .
SUBTOTAL	Totals generated by SUBTOTAL, SUB-TOTAL, RECOMPUTE, and SUMMARIZE. See Identifying Totals and Subtotals .
GRANDTOTAL	The last total on a report, which can either be a column total generated by COLUMN-TOTAL or a grand total generated by SUBTOTAL, SUB-TOTAL, RECOMPUTE, or SUMMARIZE. See Identifying Totals and Subtotals .
RECAP	Lines generated by ON field name RECAP or ON field name COMPUTE. See Identifying Totals and Subtotals .
UNDERLINE	Underlines generated by ON field name UNDER-LINE. See Identifying a Page Number, Underline, or Skipped Line .
SKIPLINE	Skipped lines generated by ON field name SKIP-LINE. See Identifying a Page Number, Underline, or Skipped Line .
FREETEXT	FML free text. See Identifying a Heading, Footing, Title, or FML Free Text .

Within certain components, you can select specific subcomponents. For example, within a heading, you can isolate a particular line or a particular field. You identify subcomponents with selection attributes (also called qualifiers). For example, to choose the third column for the entire report, use the parameters:

- TYPE=REPORT
- COLUMN=3

Identifying an Entire Report, Column, or Row

You can apply formatting to an:

- **Entire report.** For more information, see [Identify the Entire Report](#).
- **Entire column** within a report, both its title and data (including ROW-TOTAL columns). For more information, see [Identify an Entire Column](#).
- **Entire row** within a report, either an FML (Financial Modeling Language) row, or a total or subtotal row comprising the labeling text and data of the row. For more information, see [Identify an Entire Financial Modeling Language \(FML\) Row](#), and [Identify an Entire Total or Subtotal Row](#).

You can also identify an entire horizontal sort (ACROSS) title or value row in a StyleSheet, although each of these rows contains only a single kind of information. For details, see [Identify a Column Title](#).

The following illustrates where the REPORT component and the COLUMN and ACROSSCOLUMN attributes appear in a report, and which TYPE values you use to identify them. Although in this example the value for COLUMN is B1 and the value for ACROSSCOLUMN is N2, these are not the only values you can use to identify these components.

```
TABLE FILE CENTORD
SUM LINEPRICE LINE_COGS AS 'Line Cost of,Goods Sold'
BY PLANT AS 'Plant'
ACROSS YEAR
WHERE YEAR EQ 2000 OR 2001
HEADING
"Cost Analysis"
FOOTING CENTER
"***End of Report**"
ON TABLE SET PAGE-NUM OFF
END
```

TYPE=REPORT				
Cost Analysis				
YEAR				
2000		2001		
Plant	Line Total	Line Cost of Goods Sold	Line Total	Line Cost of Goods Sold
BOS	\$1,144,222.47	955,189.00	\$125,470,864.68	109,839,382.00
DAL	\$291,718.75	230,249.00	\$46,868,840.52	41,129,581.00
LA	\$1,433.30	986.00	\$27,668,201.82	24,027,600.00
ORL			\$46,955,479.15	41,143,292.00
SEA			\$10,906,551.21	9,578,621.00
STL	\$560,831.70	458,317.00	\$93,875,795.10	81,807,263.00
End of Report				

TYPE=REPORT,COLUMN=B1 TYPE=REPORT,ACROSSCOLUMN=N2

i Note: Since this request simply illustrates where the components appear in a report, it omits a StyleSheet.

Identify the Entire Report

To select the entire report, use the syntax:

```
TYPE = REPORT
```

Identify an Entire Column

```
TYPE=REPORT, coltype=column
```

where:

coltype

Specifies the type of column. It can be:

COLUMN specifies a sort column (generated by BY), a display column (generated by PRINT, LIST, SUM, or COUNT), a computed column (generated by COMPUTE), or a column of row totals (generated by ROW-TOTAL).

ACROSSCOLUMN specifies every instance of a column that is repeated across a horizontal sort (ACROSS) row.

column

Specifies one or more columns. If you are identifying an ACROSSCOLUMN, the only valid identifiers are Nn and Pn .

Options for identifying columns in a StyleSheet are:

Identifier	Description
Nn	Identifies a column by its position in the report. To determine this value, count vertical sort (BY) fields, display fields, and ROW-TOTAL fields, from left to right, including NOPRINT fields. For an example, see Identify a Column of Data .
Pn	Identifies a column by its position in the report. To determine the value of n , count vertical sort (BY) fields, display fields, and ROW-TOTAL fields from left to right. Do not count NOPRINT fields.
Cn	Identifies a display column by its position in the report. To determine the value of n , count only display fields from left to right, including NOPRINT fields. Do not count vertical sort (BY) fields or ROW-TOTAL fields. To select all display fields use C^* .
Bn	Identifies a vertical sort (BY) column by its position in the report. To determine the value of n , count only vertical sort (BY) fields, including NOPRINTs, from left to right. To select all BY fields use B^* .
field	Identifies a column by its field name. When a field occurs more than once, use $field(n)$ to select a

Identifier	Description
	particular occurrence or field(*) to select all occurrences of the field.
ROWTOTAL	<p>Identifies a column of row totals generated using ROWTOTAL. When used with ACROSS and multiple display commands, ROWTOTAL generates multiple total columns. Use ROWTOTAL(<i>n</i>) to select a particular total column. Use ROWTOTAL(<i>field</i>) to select the row total column for a particular field.</p> <p>Use ROWTOTAL(*) to select all row total columns in the report.</p>

i Note: Within a StyleSheet, all columns must be specified in the same way, either by field name or positional reference.

Identifying an Entire Column

The following illustrates how to identify an entire column, which consists of the column data and the column title, in a report. The relevant StyleSheet declaration is highlighted in the request.

i Note: To produce the same results you can, alternatively, use the values P1, B1, or the field name (PRODNAME) for the COLUMN attribute in the StyleSheet declaration.

```
TABLE FILE CENTINV
HEADING
"Excess Stock Report"
SUM QTY_IN_STOCK
BY PRODNAME
WHERE QTY_IN_STOCK GT 10000
FOOTING CENTER
"***End of Report**"
ON TABLE SET PAGE-NUM OFF
```

```

ON TABLE HOLD FORMAT HTML
ON TABLE SET STYLE *
TYPE=REPORT, GRID=OFF,$
TYPE=REPORT, COLUMN=N1, STYLE=ITALIC,$
ENDSTYLE
END

```

The output is:

Excess Stock Report	
<i>Product</i>	Quantity
<u>Name:</u>	<u>In Stock:</u>
<i>AR2 35MM Camera 8 X</i>	11499
<i>AR3 35MM Camera 10 X</i>	12444
<i>Combo Player - 4 Hd VCR + DVD</i>	13527
<i>QX Portable CD Player</i>	22000
<i>ZC Digital PDA - Standard</i>	33000
<i>ZT Digital PDA - Commercial</i>	21000
<i>2 Hd VCR LCD Menu</i>	43068
<i>250 8MM Camcorder 40 X</i>	60073
<i>330DX Digital Camera 1024K P</i>	12707
<i>750SL Digital Camcorder 300 X</i>	10758
End of Report	

Identifying an Entire Horizontal (ACROSS) Column

The following illustrates how to identify a horizontal (ACROSS) column. When you identify and format an ACROSSCOLUMN, all data values and the column title sort. The relevant StyleSheet declarations are highlighted in the request.

i Note: To produce the same results you can alternatively use the values P1 and P2, respectively, for the ACROSSCOLUMN attribute.

```

TABLE FILE CENTORD
SUM LINEPRICE LINE_COGS AS 'Line Cost of,Goods Sold'
BY PLANT AS 'Plant'

```

```

ACROSS YEAR
WHERE YEAR EQ 2000 OR 2001
HEADING
"Cost Analysis"
FOOTING CENTER
"***End of Report***"
ON TABLE SET PAGE-NUM OFF
ON TABLE HOLD FORMAT HTML
ON TABLE SET STYLE *
TYPE=REPORT, GRID=OFF,$
TYPE=REPORT, ACROSSCOLUMN=N1, STYLE=ITALIC,$
TYPE=REPORT, ACROSSCOLUMN=N2, STYLE=BOLD,$
ENDSTYLE
END

```

The output is:

Cost Analysis				
YEAR				
2000		2001		
Plant	<i>Line Total</i>	Line Cost of Goods Sold	<i>Line Total</i>	Line Cost of Goods Sold
BOS	<i>\$1,144,222.47</i>	955,189.00	<i>\$125,470,864.68</i>	109,839,382.00
DAL	<i>\$291,718.75</i>	230,249.00	<i>\$46,868,840.52</i>	41,129,581.00
LA	<i>\$1,433.30</i>	986.00	<i>\$27,668,201.82</i>	24,027,600.00
ORL	.	.	<i>\$46,955,479.15</i>	41,143,292.00
SEA	.	.	<i>\$10,906,551.21</i>	9,578,621.00
STL	<i>\$560,831.70</i>	458,317.00	<i>\$93,875,795.10</i>	81,807,263.00
End of Report				

Identify an Entire Financial Modeling Language (FML) Row

```
TYPE=REPORT, LABEL=label
```

where:

Rn

Is an implicit row label. To determine the value of n , count the number of rows up to and including the desired row.

label

Is an explicit row label.

Identifying an Entire FML Row

The following illustrates how to identify an entire FML row, consisting of the row label and the row data. The relevant StyleSheet declarations are highlighted in the request.

```
TABLE FILE LEDGER
SUM AMOUNT FOR ACCOUNT
1010 AS 'CASH ON HAND' LABEL COH OVER
1020 AS 'DEMAND DEPOSITS' LABEL DD OVER
1030 AS 'TIME DEPOSITS' LABEL TD OVER
BAR OVER
RECAP TOTCASH = R1 + R2 + R3; AS 'TOTAL CASH'
ON TABLE SET PAGE-NUM OFF
ON TABLE HOLD FORMAT HTML
ON TABLE SET STYLE *
TYPE=REPORT, GRID=OFF, $
TYPE=REPORT, LABEL=COH, STYLE=ITALIC, $
TYPE=REPORT, LABEL=DD, STYLE=ITALIC, $
TYPE=REPORT, LABEL=TD, STYLE=ITALIC, $
ENDSTYLE
END
```

The output is:

	<u>AMOUNT</u>
CASH ON HAND	8,784
DEMAND DEPOSITS	4,494
TIME DEPOSITS	7,961

TOTAL CASH	21,239

Identify an Entire Total or Subtotal Row

TYPE=type, [BY=sortcolumn]

where:

type

Identifies a subtotal or total. Select from:

GRANDTOTAL which is a grand total (generated by COLUMN-TOTAL, SUBTOTAL, SUB-TOTAL, RECOMPUTE, or SUMMARIZE).

SUBTOTAL which is a subtotal (generated by SUBTOTAL, SUB-TOTAL, RECOMPUTE, or SUMMARIZE).

RECAP which is a subtotal calculation (generated by ON *sortfield* RECAP or ON *sortfield* COMPUTE).

BY

When there are several subtotal commands, each associated with a different vertical sort (BY) column, this enables you to identify which of the subtotal commands you wish to format.

sortcolumn

Specifies the vertical sort (BY) column associated with one of a report's several subtotal commands. Use the field name to identify the sort column.

Identifying an Entire Total Row

The following illustrates how to identify an entire COLUMN-TOTAL row in a StyleSheet. The relevant StyleSheet declaration is highlighted in the request.

```
TABLE FILE SALES
SUM RETURNS DAMAGED AND ROW-TOTAL AND COLUMN-TOTAL
BY PROD_CODE
ON TABLE SET PAGE-NUM OFF
ON TABLE HOLD FORMAT HTML
ON TABLE SET STYLE *
TYPE=REPORT, GRID=OFF, $
TYPE=GRANDTOTAL, STYLE=BOLD, SIZE=12, $
ENDSTYLE
END
```

The output is:

<u>PROD_CODE</u>	<u>RETURNS</u>	<u>DAMAGED</u>	<u>TOTAL</u>
B10	13	10	23
B12	4	3	7
B17	4	2	6
B20	1	2	3
C13	3	0	3
C17	0	0	0
C7	5	4	9
D12	3	2	5
E1	4	7	11
E2	9	4	13
E3	12	11	23
TOTAL	58	45	103

Identifying a Row Total

The following illustrates how to identify a row total. The relevant StyleSheet declaration is highlighted in the request. Note that if you want to format an instance of row-total, you

can add a WHEN statement to your StyleSheet. For details, see [Conditionally Formatting in a StyleSheet](#).

```
TABLE FILE SALES
SUM RETURNS DAMAGED AND ROW-TOTAL
BY PROD_CODE AS 'PRODUCT, CODE'
ON TABLE SET PAGE-NUM OFF
ON TABLE HOLD FORMAT PS
ON TABLE SET STYLE *
TYPE=REPORT, GRID=OFF, $
TYPE=REPORT, COLUMN=ROWTOTAL, STYLE=BOLD, $
ENDSTYLE
END
```

The output is:

<u>PRODUCT</u> <u>CODE</u>	<u>RETURNS</u>	<u>DAMAGED</u>	<u>TOTAL</u>
B10	13	10	23
B12	4	3	7
B17	4	2	6
B20	1	2	3
C13	3	0	3
C17	0	0	0
C7	5	4	9
D12	3	2	5
E1	4	7	11
E2	9	4	13
E3	12	11	23

Identifying Data

You can identify and format many categories of data in a report, including:

- **All of a report's data.** For more information, see [Identifying Report Components](#).
- **Columns of data**, including sort columns and display columns. For more information, see [Identify a Column of Data](#).
- **Sort rows** (that is, ACROSS field values). For more information, see [Identify a Row of](#)

Horizontal Sort (ACROSS) Data.

- **Totals and subtotals.** For more information, see [Identifying Totals and Subtotals](#).

The following illustrates where the DATA and ACROSSVALUE components appear in a report, and which TYPE values you use to identify them.

```
TABLE FILE CENTORD
HEADING CENTER
"UNITS SOLD IN 2002 BY PLANT"
SUM QUANTITY AND ROW-TOTAL AS '2002 TOTAL'
ACROSS QUARTER
BY PLANTLNG AS 'PLANT'
WHERE YEAR EQ 2002
ON TABLE COLUMN-TOTAL AS 'TOTAL UNITS'
ON TABLE SET PAGE-NUM OFF
END
```

		UNITS SOLD IN 2002 BY PLANT				
		QUARTER	Q2	Q3	Q4	2002 TOTAL }
TYPE=ACROSSVALUE	PLANT	{ Q1				
TYPE=DATA	Boston	181,055	138,752	27,103	83,240	430,150
	Dallas	31,495	53,141	34,675	35,743	155,054
	Los Angeles	42,752	25,232	44,240	29,926	142,150
	Orlando	33,375	47,691	27,635	42,873	151,574
	Seattle	14,509	24,538	4,532	4,560	48,139
	St Louis	103,571	30,669	50,335	29,584	214,159
	TOTAL UNITS	406,757	320,023	188,520	225,926	1,526,451

Note: Since this request simply illustrates where the components appear in a report, it omits a StyleSheet.

Identify All Data

To identify all report data in a StyleSheet, except for column totals, grand totals, subtotals, and horizontal sort (ACROSS) values, which need to be identified separately, use this attribute and value:

```
TYPE = DATA
```

Identifying All Data in a Report

The following illustrates how to identify all of the data in a report. The relevant StyleSheet declaration is highlighted in the request.

```
TABLE FILE CENTORD
HEADING CENTER
"UNITS SOLD IN 2002 BY PLANT"
SUM QUANTITY AND ROW-TOTAL AS '2002 TOTAL'
ACROSS QUARTER
BY PLANTLNG AS 'PLANT'
WHERE YEAR EQ 2002
ON TABLE COLUMN-TOTAL AS 'TOTAL UNITS'
ON TABLE SET PAGE-NUM OFF
ON TABLE HOLD FORMAT HTML
ON TABLE SET STYLE *
TYPE=REPORT, GRID=OFF, $
TYPE=DATA, STYLE=BOLD, $
ENDSTYLE
END
```

In the output, the titles and grand total are not bolded because they are not data values:

UNITS SOLD IN 2002 BY PLANT					
QUARTER					
PLANT	Q1	Q2	Q3	Q4	2002 TOTAL
Boston	165,938	202,100	84,571	86,227	538,836
Dallas	62,693	63,403	35,747	42,094	203,937
Los Angeles	55,542	30,326	17,188	16,869	119,925
Orlando	76,261	57,639	32,595	35,895	202,390
Seattle	16,887	17,496	5,454	5,512	45,349
St Louis	150,293	109,284	65,161	80,530	405,268
TOTAL UNITS	527,614	480,248	240,716	267,127	1,515,705

Identify a Column of Data

```
TYPE=DATA, COLUMN=column
```

where:

column

Specifies one or more columns that you wish to format. For a list of values, see [Identify an Entire Column](#).

Identifying a Column of Data

The following illustrates how to identify a column of data. The relevant StyleSheet declaration is highlighted in the request.

Note that when identifying a column using Nn , NOPRINT columns are counted. Even though the Product Name field is the first column in this report, it is identified with N2 because of the NOPRINT column.

```
TABLE FILE CENTORD
PRINT QUANTITY LINEPRICE LINE_COGS
BY ORDER_NUM NOPRINT
BY PRODNAME
WHERE ORDER_NUM EQ '48045'
ON TABLE SET PAGE-NUM OFF
ON TABLE HOLD FORMAT HTML
ON TABLE SET STYLE *
TYPE=REPORT, GRID=OFF,$
TYPE=DATA, COLUMN=N2, STYLE=ITALIC,$
ENDSTYLE
END
```

The output is:

Product <u>Name:</u>	<u>Quantity:</u>	Line <u>Total</u>	Line <u>Cost Of</u> <u>Goods Sold</u>
<i>DVD Upgrade Unit for Cent. VCR</i>	121	\$18,177.77	16,819.00
<i>QX Portable CD Player</i>	266	\$33,847.80	26,334.00
<i>110 VHS-C Camcorder 20 X</i>	266	\$70,901.90	66,234.00
<i>120 VHS-C Camcorder 40 X</i>	266	\$76,511.09	68,894.00
<i>150 8MM Camcorder 20 X</i>	121	\$28,473.78	29,040.00

Identify a Row of Horizontal Sort (ACROSS) Data

```
TYPE=ACROSSVALUE, [ACROSS={fieldname|Nn}]
```

where:

ACROSS

If you have a request with multiple ACROSS fields, you can identify each field using the ACROSS identifier. You only need to include the ACROSS identifier if you have multiple ACROSS fields in your request.

fieldname

Specifies a horizontal sort row by its field name.

Nn

Specifies a horizontal sort row by its position in the sequence of horizontal sort rows.

Identifying a Row of Horizontal Sort (ACROSS) Data

The following illustrates how to identify a row of horizontal data values. The relevant StyleSheet declaration is highlighted in the request.

```

TABLE FILE CENTORD
HEADING
"Units Sold"
SUM QUANTITY
BY PRODNAME
ACROSS PLANT AS 'Manufacturing Plant'
WHERE PRODTYPE EQ 'Digital'
ON TABLE SET PAGE-NUM OFF
ON TABLE HOLD FORMAT HTML
ON TABLE SET STYLE *
TYPE=REPORT, GRID=OFF, $
TYPE=HEADING, SIZE=12, $
TYPE=ACROSSVALUE, ACROSS=PLANT, STYLE=BOLD, $
ENDSTYLE
END

```

The output is:

Units Sold	Manufacturing Plant					
	BOS	DAL	LA	ORL	SEA	STL
Product Name:						
Combo Player - 4 Hd VCR + DVD	27,687	15,985	9,634	13,816	2,359	22,097
DVD Upgrade Unit for Cent. VCR	47,112	25,602	16,152	23,429	4,539	32,875
QX Portable CD Player	108,696	35,355	26,215	46,388	8,056	83,564
R5 Micro Digital Tape Recorder	188,384	73,255	41,169	63,120	15,385	142,714
ZC Digital PDA - Standard	45,890	13,154	4,664	10,249	6,439	30,213
ZT Digital PDA - Commercial	181,750	70,111	41,149	61,244	15,039	130,942
330DX Digital Camera 1024K P	3,949	2,767	562	561	2	1,132
650DL Digital Camcorder 150 X	44,930	14,548	7,995	17,972	4,967	31,436
750SL Digital Camcorder 300 X	4,098	2	6	283	642	1,644

i Note: To produce the same results you can alternatively use the value N1 for the ACROSS attribute in the StyleSheet declaration. For example, TYPE=ACROSSVALUE, ACROSS=N1, STYLE=BOLD, \$.

Identifying Totals and Subtotals

Within a StyleSheet, you can identify a report's grand totals, subtotals, subtotal calculations (generated by *ON sortfield* RECAP or *ON sortfield* COMPUTE), column totals, and row totals in order to format them. For details on identifying row totals, see [Identifying an Entire Report, Column, or Row](#).

The following example illustrates where these components are in a report, and which TYPE values you use to identify them.

```
TABLE FILE EMPLOYEE
SUM DED_AMT AND GROSS
BY DEPARTMENT BY PAY_DATE
ON DEPARTMENT RECAP DEPT_NET/D8.2M = GROSS-DED_AMT;
WHEN PAY_DATE GT 820101
ON DEPARTMENT SUBTOTAL
END
```

DEPARTMENT	PAY_DATE	DED_AMT	GROSS	
MIS	81/11/30	\$1,406.79	\$2,147.75	
	81/12/31	\$1,406.79	\$2,147.75	
*TOTAL MIS		\$2813.58	\$4295.50	← TYPE = SUBTOTAL
** DEPT_NET		\$2,311.98		← TYPE = RECAP

PRODUCTION	81/11/30	\$141.66	\$833.33	
	82/01/29	\$1,560.09	\$3,705.84	
*TOTAL PRODUCTION		\$1701.75	\$4539.17	← TYPE = SUBTOTAL
** DEPT_NET		\$2,531.14		← TYPE = RECAP

TOTAL		\$5,578.35	\$10,421.47	← TYPE = GRANDTOTAL

Note: Since this request simply illustrates how to identify different types of totals and subtotals, it omits a StyleSheet.

Identify a Grand Total, Subtotal, or Subtotal Calculation

```
TYPE=type, [BY=sortfield] [coltype=column]
```

where:

type

Identifies a subtotal or total. Select from:

GRANDTOTAL which is a grand total (generated by COLUMN-TOTAL, SUBTOTAL, SUB-TOTAL, RECOMPUTE, or SUMMARIZE).

SUBTOTAL which is a subtotal (generated by SUBTOTAL, SUB-TOTAL, RECOMPUTE, or SUMMARIZE).

RECAP which is a subtotal calculation (generated by ON *sortfield* RECAP or ON *sortfield* COMPUTE).

BY

If you have requests with multiple BY fields, and two or more have subtotal commands associated with them, you can identify each field using the BY identifier. This is helpful when you want to format each subtotal differently or when you want to format only one subtotal.

You need to include the BY identifier only if you have multiple BY fields in your request.

sortfield

Specifies the BY field associated with one of a report's several subtotal commands. Use the fieldname for the value (BY=*fieldname*).

coltype

Identifies a specific column for formatting. When you include the COLUMN or ACROSSCOLUMN identifier in your declaration, only the subtotal *values* receive the formatting; the labeling text will not. Values can be:

COLUMN which is a display column (generated by PRINT, LIST, SUM, or COUNT) or a computed column (generated by COMPUTE).

ACROSSCOLUMN where every instance of a display or computed column that is repeated across a horizontal sort (ACROSS) row.

If there are several columns being totaled or subtotaled by one command, and you do not specify a column in the StyleSheet, the formatting will be applied to the totals or subtotaals for *all* of the columns. It will also be applied to the labeling text for the total and subtotal values.

column

Specifies the column whose totals or subtotaals you wish to format. For a list of values, see [Identify an Entire Column](#).

Identifying Subtotals and the Grand Total

The following illustrates how to identify subtotals and the grand total in a report request. In this example, only subtotal values in the QUANTITY and LINE_COGS fields are formatted, so the COLUMN attribute is included in the StyleSheet declarations.

The grand total in this request is generated by COLUMN-TOTAL.

Since there are two SUBTOTAL commands associated with two of the three BY fields (PLANT and ORDER_NO), the BY attribute is also included in each declaration to ensure the formatting is applied to the correct value.

```
TABLE FILE CENTORD
SUM QUANTITY LINE_COGS AS 'Line Cost of, Goods Sold'
BY PLANT AS 'Plant'
BY ORDER_NUM AS 'Order,Num'
BY PRODNAME
ON PLANT SUBTOTAL AS 'Total:'
ON ORDER_NUM SUBTOTAL AS 'Total:'
WHERE ORDER_NUM EQ '35774' OR '48041'
WHERE PLANT EQ 'BOS'
ON TABLE SET PAGE-NUM OFF
ON TABLE HOLD FORMAT HTML
ON TABLE SET STYLE *
TYPE=REPORT, GRID=OFF,$
TYPE=SUBTOTAL, BY=PLANT, COLUMN=LINE_COGS, STYLE=BOLD+ITALIC,
COLOR=BLUE,$
TYPE=SUBTOTAL, BY=ORDER_NUM, COLUMN=QUANTITY, STYLE=BOLD, SIZE=11,$
TYPE=GRANDTOTAL, COLUMN=QUANTITY, STYLE=ITALIC, SIZE=11,$
ENDSTYLE
END
```

The output is:

<u>Order</u>	<u>Product</u>	<u>Line</u>	<u>Cost of</u>
<u>Plant</u>	<u>Num</u>	<u>Name:</u>	<u>Quantity: Goods Sold</u>
BOS	35774	110 VHS-C Camcorder 20 X	146 36,354.00
		120 VHS-C Camcorder 40 X	146 37,814.00
		2 Hd VCR LCD Menu	279 35,991.00
		650DL Digital Camcorder 150 X	146 103,660.00
Total: 35774			717 213,819.00
	48041	Combo Player - 4 Hd VCR + DVD	1 289.00
		DVD Upgrade Unit for Cent. VCR	1 139.00
		R5 Micro Digital Tape Recorder	1 69.00
		ZT Digital PDA - Commercial	1 349.00
		150 8MM Camcorder 20 X	1 240.00
Total: 48041			5 1,086.00
Total: BOS			722 214,905.00

i Note:

- To style the entire grand total row, remove the COLUMN attribute from the StyleSheet declaration.
- To produce the same results, you can alternatively use the values N5, P5, or C3 for the COLUMN attribute in the StyleSheet declaration.
- To style an entire subtotal row, remove the COLUMN and BY attributes from the StyleSheet declaration.
- To produce the same results you can, alternatively, use the values COLUMN=N6, COLUMN=P6, or COLUMN=C3 for the COLUMN=LINE_COGS attribute.
- To produce the same results you can, alternatively, use the values COLUMN=N4, COLUMN=P4, or COLUMN=C1 for the COLUMN=QUANTITY attribute.

Identifying a Subtotal Calculation (RECAP/COMPUTE)

The following illustrates how to identify a subtotal calculation created with a RECAP or COMPUTE phrase. In this example, the subtotal calculation is generated with ON PLANT RECAP QTY/F6=QUANTITY. The relevant StyleSheet declaration is highlighted in the request.

i Note: If there are multiple RECAP or COMPUTE fields in your request, you can distinguish them by adding *BY=fieldname* to the StyleSheet declaration.

```
TABLE FILE CENTORD
SUM QUANTITY LINEPRICE LINE_COGS AS 'Line Cost of, Goods Sold'
BY PLANT AS 'Plant' BY ORDER_NUM
ON PLANT RECAP QTY/F6=QUANTITY;
WHERE PLANT EQ 'BOS'
WHERE ORDER_NUM GT '60000' AND ORDER_NUM LT '70000'
ON TABLE SET PAGE-NUM OFF
ON TABLE HOLD FORMAT HTML
ON TABLE SET STYLE *
TYPE=REPORT, GRID=OFF, $
TYPE=RECAP, STYLE=BOLD+ITALIC, $
ENDSTYLE
END
```

The output is:

<u>Plant</u>	<u>Order Number:</u>	<u>Quantity:</u>	<u>Line</u>	<u>Line</u>	<u>Cost of</u>
			<u>Total</u>	<u>Goods</u>	<u>Sold</u>
BOS	68290	1,306	\$304,816.76	268,366.00	
	68327	5	\$1,923.45	1,456.00	
	68580	1,015	\$236,729.89	209,487.00	
	68710	4	\$994.44	757.00	
	68900	11	\$3,760.44	2,617.00	
		** QTY	2341		

Styling Multiple RECAP Statements in a Matrix

You can style multiple RECAP commands in a matrix when the RECAP statements are placed after the last ACROSS value:

```
TABLE FILE GGSales
SUM UNITS
BY PRODUCT
ACROSS REGION
RECAP
TTL1/I8=C1+C2+C3+C4;
TTL2/D12.2=TTL1*1.25;
ON TABLE HOLD FORMAT HTML
ON TABLE SET STYLE *
TYPE=DATA, COLUMN=TTL1 (*), COLOR=BLUE, BACKCOLOR=SILVER, STYLE=BOLD, $
TYPE=DATA, COLUMN=TTL2 (*), COLOR=RED, BACKCOLOR=AQUA, STYLE=BOLD, $
ENDSTYLE
END
```

The output is:

Product	Region				TTL1	TTL2
	Midwest	Northeast	Southeast	West		
Biscotti	86105	145242	119594	70436	421377	526,721.25
Capuccino		44785	73264	71168	189217	236,521.25
Coffee Grinder	50393	40977	47083	48081	186534	233,167.50
Coffee Pot	47156	46185	49922	47432	190695	238,368.75
Croissant	139182	137394	156456	197022	630054	787,567.50
Espresso	101154	68127	68030	71675	308986	386,232.50
Latte	231623	222866	209654	213920	878063	1,097,578.75
Mug	86718	91497	88474	93881	360570	450,712.50
Scone	116127	70732	73779	72776	333414	416,767.50
Thermos	46587	48870	48976	45648	190081	237,601.25

Identifying Tags for SUBTOTAL and GRANDTOTAL Lines

The tag is the text that is displayed in the leftmost portion of each SUBTOTAL and GRANDTOTAL row in a report. The tag is used to identify the type of data represented

within this row. The text used to generate this tag can be customized by adding an AS name to the SUBTOTAL syntax.

You can define styling for the subtotal and grand total tag separately from the rest of the row. Text attributes available for the tag, including font, color, size, and style, can be used to differentiate and highlight the tags. Additionally, styling can be applied that turns tags into drill-down links.

Styling is supported for text attributes only. Cell or column features, such as borders, background color, or justification are not supported.

This feature is available for PDF, DHTML, PS, HTML, AHTML, PPTX, XLSX, and EXL2K formats.

Style Subtotal and Grand Total Tags

```
TYPE={SUBTOTAL|GRANDTOTAL}, OBJECT=TAG,  
  [FONT=font], [SIZE=size], [STYLE=style],  
  [COLOR={color|RGB({rgb|#hexcolor})}],  
  [drilltype=drillparms], $
```

where:

font

Is the name of the font.

size

Is the point size of the font.

style

Is the font style, for example bold, italic, or bold + italic.

color

Is a color name.

rgb

Specifies the font color using a mixture of red, green, and blue.

(r g b) is the desired intensity of red, green, and blue, respectively. The values are on a scale of 0 to 255, where 0 is the least intense and 255 is the most intense. Note that using the three color components in equal intensities results in shades of gray.

#hexcolor

Is the hexadecimal value for the color. For example, FF0000 is the hexadecimal value for red. The hexadecimal digits can be in uppercase or lowercase and must be preceded by a pound sign (#).

linktype

Is any valid link attribute, for example, URL=. For more information about links, see [Advanced StyleSheet Features](#).

drillparms

Are valid attribute values for the type of link.

Styling SUBTOTAL and GRANDTOTAL Tags

The following request against the GGSALES data source generates subtotal and grand total rows. The tags for the subtotal rows are in italics and are red. The tag for the grand total row has a drill-down link to a URL:

```
TABLE FILE GGSALES
SUM UNITS/D8C DOLLARS/D12CM BUDUNIT/D8C BUDDOLLARS/D12CM
BY REGION
BY CATEGORY
ON REGION SUBTOTAL
HEADING CENTER
"Gotham Grinds Sales Report"
ON TABLE SET HTMLCSS ON
ON TABLE HOLD FORMAT PDF
ON TABLE SET DROPBLNKLINE ALL
ON TABLE SET PAGE-NUM OFF
ON TABLE SET STYLE *
TYPE=SUBTOTAL, OBJECT=TAG,STYLE=ITALIC,COLOR=RED,$
TYPE=GRANDTOTAL, BACKCOLOR='LIGHT GREY',$
TYPE=GRANDTOTAL, OBJECT=TAG,URL='http://www.informationbuilders.com',$
ENDSTYLE
END
```

The output is:

Gotham Grinds Sales Report				
Region	Category	Unit Sales	Dollar Sales	Budget Units
Midwest	Coffee	332,777	\$4,178,513	335,526
	Food	346,421	\$4,404,483	344,502
	Gifts	234,463	\$2,931,349	236,105
*TOTAL Midwest		913,661	\$11,514,345	916,133
Northeast	Coffee	339,155	\$4,201,057	339,037
	Food	357,919	\$4,445,197	355,477
	Gifts	227,529	\$2,848,289	227,008
*TOTAL Northeast		924,603	\$11,494,543	921,522
Southeast	Coffee	352,357	\$4,435,134	357,228
	Food	349,829	\$4,308,731	351,509
	Gifts	237,928	\$3,037,420	238,328
*TOTAL Southeast		940,114	\$11,781,285	947,065
West	Coffee	358,426	\$4,493,483	360,247
	Food	340,367	\$4,204,333	335,682
	Gifts	235,042	\$2,977,092	236,636
*TOTAL West		933,835	\$11,674,908	932,565
TOTAL		3,712,213	\$46,465,081	3,717,285

Identifying a Heading, Footing, Title, or FML Free Text

A report's data is framed by headings, footings, and titles; these provide context for the data. You can identify and format many categories of headings, footings, and titles in a report, including:

- Report, page, and sort headings.
- Report, page, and sort footings.
- Column titles.
- Horizontal sort (ACROSS) titles and values.
- Free text in Financial Modeling Language (FML) reports.

You can also use a StyleSheet to create a report title that:

- Overrides the default report title (FOCUS Report) that appears in your browser's title bar in an HTML report.
- Replaces the default worksheet tab name with the name specified in an EXL2K report.

Identifying a Column or Row Title

Within a StyleSheet, you can identify a report's column titles and horizontal sort (ACROSS) values to format. The following example illustrates where column titles and horizontal sort values are stored in a report, and which TYPE values you use to identify them.

```
TABLE FILE EMPLOYEE
SUM GROSS AND DED_AMT
ACROSS DEPARTMENT BY PAY_DATE
END
```

DEPARTMENT ←		PRODUCTION ←		
MIS		GROSS		
PAY_DATE	GROSS	DED_AMT	GROSS	DED_AMT
81/11/30	\$2,147.75	\$1,406.79	\$833.33	\$141.66
81/12/31	\$2,147.75	\$1,406.79	\$833.33	\$141.66
82/01/29	\$3,247.75	\$1,740.89	\$3,705.84	\$1,560.09
82/02/26	\$3,247.75	\$1,740.89	\$4,959.84	\$2,061.69
82/03/31	\$3,247.75	\$1,740.89	\$4,959.84	\$2,061.69
82/04/30	\$5,890.84	\$3,386.73	\$4,959.84	\$2,061.69
82/05/28	\$6,649.50	\$3,954.35	\$7,048.84	\$3,483.88
82/06/30	\$7,460.00	\$4,117.03	\$7,048.84	\$3,483.88
82/07/30	\$7,460.00	\$4,117.03	\$7,048.84	\$3,483.88
82/08/31	\$9,000.00	\$4,575.72	\$9,523.84	\$4,911.12



Note: Since this request simply illustrates how to identify column titles and horizontal sort values in a report, it omits a StyleSheet.

Identify a Column Title

```
TYPE=TITLE, [COLUMN=column]
```

where:

COLUMN

Is used to specify one or more column titles. If you omit this attribute and value, the formatting will be applied to all of the report's column titles.

column

Specifies the column whose title you wish to format. For column values, see [Identify an Entire Column](#).

Identify a Horizontal Sort Title or Value

```
TYPE={ACROSSTITLE|ACROSSVALUE}, [ACROSS=column]
```

where:

ACROSSTITLE

Specifies a horizontal sort (ACROSS) title.

ACROSSVALUE

Specifies a horizontal sort (ACROSS) value.

Although horizontal sort values are not technically titles, they often function as titles that categorize the column titles appearing beneath them.

ACROSS

Is used to specify titles or values for a specific horizontal sort field. If you omit this attribute and value, the formatting will be applied to the titles or values of all of the report's horizontal sort fields.

column

Specifies the horizontal sort (ACROSS) field whose title or values you wish to format. For values you can assign to this attribute, see [Identify a Row of Horizontal Sort \(ACROSS\) Data](#).

Identifying Column Titles and Horizontal Sort (ACROSS) Values

The following illustrates how to identify vertical sort titles, horizontal sort titles, and horizontal sort values. The vertical sort titles (TYPE=TITLE) are Manufacturing Plant, Quantity Sold and Product Cost; the horizontal sort title (TYPE=ACROSSTITLE) is Year; and

the horizontal sort values (TYPE=ACROSSVALUE) are 1999, 2000, and 2001. The StyleSheet declarations that identify these components are highlighted in the request.

```
TABLE FILE CENTORD
SUM QUANTITY AS 'Quantity,Sold' LINE_COGS/I9 AS 'Product,Cost'
BY PLANT
ACROSS YEAR
WHERE YEAR EQ '2000' OR '2001' OR '2002'
HEADING
"Plant Production Cost Analysis"
ON TABLE SET PAGE-NUM OFF
ON TABLE HOLD FORMAT HTML
ON TABLE SET STYLE *
TYPE=REPORT, GRID=OFF,$
TYPE=TITLE, STYLE=BOLD, $
TYPE=ACROSSTITLE, STYLE=BOLD, $
TYPE=ACROSSVALUE, STYLE=BOLD+ITALIC, COLOR=BLUE, $
TYPE=ACROSSVALUE, COLUMN=N4, STYLE=BOLD, COLOR=RED, $
ENDSTYLE
END
```

The output is:

Plant Production Cost Analysis						
	YEAR					
	<i>2000</i>		<i>2001</i>		<i>2002</i>	
Manufacturing Plant	Quantity Sold	Product Cost	Quantity Sold	Product Cost	Quantity Sold	Product Cost
BOS	3,902	955189	491,080	109839382	538,836	120518527
DAL	1,122	230249	185,785	41129581	203,937	45147907
LA	5	986	109,326	24027600	119,925	26356066
ORL	.	.	184,519	41143292	202,390	45127226
SEA	.	.	41,331	9578621	45,349	10510177
STL	2,019	458317	369,456	81807263	405,268	89734521

Identify Free Text in an FML Report

```
TYPE=FREETEXT, LABEL={Rn|label}
```

where:

Rn

Is an implicit row label. To determine the value of n , count the number of rows up to and including the desired row.

label

Is an explicit row label.

Identifying Free Text in an FML Report

The following illustrates how to identify free text in an FML report. In this example, the free text are the rows, CASH ACCOUNTS and OTHER CURRENT ASSETS. The relevant StyleSheet declarations are highlighted:

```
TABLE FILE LEDGER
SUM AMOUNT FOR ACCOUNT
" --- CASH ACCOUNTS ---" LABEL CA          OVER
1010 AS 'CASH ON HAND'                     OVER
1020 AS 'DEMAND DEPOSITS'                  OVER
1030 AS 'TIME DEPOSITS'                    OVER
" "                                         OVER
" --- OTHER CURRENT ASSETS ---" LABEL OCA  OVER
1100 AS 'ACCOUNTS RECEIVABLE'              OVER
1200 AS 'INVENTORY'
ON TABLE SET PAGE-NUM OFF
ON TABLE HOLD FORMAT HTML
ON TABLE SET STYLE *
TYPE=REPORT, GRID=OFF, $
TYPE=FREETEXT, LABEL=CA, STYLE=BOLD, SIZE=12, $
TYPE=FREETEXT, LABEL=OCA, STYLE=BOLD, SIZE=12, $
ENDSTYLE
END
```

The output is:

	<u>AMOUNT</u>
--- CASH ACCOUNTS ---	
CASH ON HAND	8,784
DEMAND DEPOSITS	4,494
TIME DEPOSITS	7,961
--- OTHER CURRENT ASSETS ---	
ACCOUNTS RECEIVABLE	18,829
INVENTORY	27,307

Create a Custom Report Title

Add the following declaration to your StyleSheet

```
TYPE=REPORT, TITLETEXT='title', $
```

where:

title

Is the text for your title.

The maximum amount of characters for:

- The worksheet tab name in an EXL2K report is 128. Any text that exceeds 128 characters will be truncated.
- The browser title for an HTML report is 95. This is a limit imposed by the browser.

Text specified in the title is placed in the file as is and is not encoded. Special characters, such as <, >, &, and so on, should not be used as they have special meaning in HTML and may produce unpredictable results.

i **Note:** The words, *Microsoft Internet Explorer* are always appended to any HTML report title.

For an example of using this technique, see [Using Excel Display Formats: XLSX, EXL2K, EXL97](#).

Identifying a Heading or Footing

Within a StyleSheet, you can identify a report's headings and footings, and the individual lines, text strings, and fields within them, in order to format them.

You can use the <TABLASTPAGE system variable to insert the total number of pages in a heading or footing. For example, if you want to add a footing in your report that reads, *Page 1 of 5*, you can use the <TABLASTPAGE system variable in conjunction with the <TABPAGENO system variable to do so.

You can also use the <BYLASTPAGE system variable to display the number of pages of output within each sort group when a report uses the REPAGE option to reset the page numbers for each sort group. If the REPAGE option is not used in the report, the total number of pages in the report (<TABLASTPAGE variable) is used for <BYLASTPAGE.

The following example illustrates where a report heading (TABHEADING), a page heading (HEADING), a sort heading (SUBHEAD), a sort footing (SUBFOOT), and a report footing (TABFOOTING) are stored in a report, and which TYPE values you use to identify them.

```
TABLE FILE EMPLOYEE
PRINT CURR_SAL HIRE_DATE
BY LAST_NAME
BY FIRST_NAME
ON TABLE SUBHEAD
"CONFIDENTIAL INFORMATION"
"SWIFTY INFORMATION GROUP - EMPLOYEE LIST BY DEPARTMENT"
HEADING CENTER
"</1>EMPLOYEE LIST FOR DEPARTMENT: <DEPARTMENT"
ON LAST_NAME SUBHEAD
"ID: <EMP_ID"
ON LAST_NAME SUBFOOT
"** REVIEW SALARY FOR <FIRST_NAME <LAST_NAME"
FOOTING
"CONFIDENTIAL INFORMATION"
ON TABLE SUBFOOT
"</1>***END OF REPORT***"
END
```

The output is:

PAGE	1				
CONFIDENTIAL INFORMATION					
SWIFTY INFORMATION GROUP - EMPLOYEE LIST BY DEPARTMENT					TYPE = TABHEADING
EMPLOYEE LIST FOR DEPARTMENT: PRODUCTION					TYPE = HEADING
LAST_NAME	FIRST_NAME	CURR_SAL	HIRE_DATE		
-----	-----	-----	-----		
ID: 119329144					TYPE = SUBHEAD
BANNING	JOHN	\$29,700.00	82/08/01		TYPE = SUBFOOT
** REVIEW SALARY FOR JOHN BANNING					
ID: 326179357					TYPE = SUBHEAD
BLACKWOOD	ROSEMARIE	\$21,780.00	82/04/01		
** REVIEW SALARY FOR ROSEMARIE BLACKWOOD					
CONFIDENTIAL INFORMATION					TYPE = FOOTING
END OF REPORT					TYPE = TABFOOTING



Note: Since this request simply illustrates how to identify different types of headings and footings, it omits a StyleSheet.

Identify a Heading or Footing

TYPE=headfoot, [BY=sortcolumn]

where:

headfoot

Identifies a heading or footing. Select from:

TABHEADING which is a report heading. This appears once at the beginning of the report and is generated by ON TABLE SUBHEAD.

TABFOOTING which is a report footing. This appears once at the end of the report and is generated by ON TABLE SUBFOOT.

HEADING which is a page heading. This appears at the top of every report page and is generated by HEADING.

FOOTING which is a page footing. This appears at the bottom of every report page and is generated by FOOTING.

SUBHEAD which is a sort heading. This appears at the beginning of a vertical (BY) sort group (generated by ON *sortfield* SUBHEAD).

SUBFOOT which is a sort footing. This appears at the end of a vertical (BY) sort group (generated by ON *sortfield* SUBFOOT).

BY

When there are several sort headings or sort footings, each associated with a different vertical sort (BY) column, you can identify which sort heading or sort footing you wish to format.

If there are several sort headings or sort footings associated with different vertical sort (BY) columns, and you omit this attribute and value, the formatting will be applied to all of the sort headings or footings.

sortcolumn

Specifies the vertical sort (BY) column associated with one of the report's sort headings or sort footings.

Identify an Individual Line in a Heading or Footing

```
TYPE=type, LINE=line_#
```

where:

type

Identifies a type of heading or footing. Select from HEADING, FOOTING, TABHEADING, TABFOOTING, SUBHEAD, or SUBFOOT. For details, see [Identify a Heading or Footing](#).

line_#

Identifies a line by its position in the heading or footing.

Identifying an Individual Line in a Heading

The following example illustrates how to format individual lines in a heading. Heading line 1 (Sales Quantity Analysis) is formatted in bold, point size 11. Heading line 2 (**Confidential**) is formatted in bold and red. The relevant StyleSheet declarations are highlighted in the request.

```
TABLE FILE CENTORD
HEADING
"Sales Quantity Analysis"
**Confidential**
" "
SUM QUANTITY
ACROSS YEAR
BY PLANT
ON TABLE SET PAGE-NUM OFF
ON TABLE HOLD FORMAT HTML
ON TABLE SET STYLE *
TYPE=REPORT, GRID=OFF, $
TYPE=HEADING, LINE=1, SIZE=11, STYLE=BOLD,$
TYPE=HEADING, LINE=2, COLOR=RED, STYLE=BOLD,$
TYPE=HEADING, JUSTIFY=CENTER,$
ENDSTYLE
END
```

The output is:

Sales Quantity Analysis			
Confidential			
	YEAR		
	2000	2001	2002
Manufacturing Plant			
BOS	3,902	491,080	538,836
DAL	1,122	185,785	203,937
LA	5	109,326	119,925
ORL	.	184,519	202,390
SEA	.	41,331	45,349
STL	2,019	369,456	405,268

Identify a Text String in a Heading or Footing

TYPE=type, [LINE=line_#], [OBJECT=TEXT], ITEM=item_#

where:

type

Identifies a type of heading or footing. Select from HEADING, FOOTING, TABHEADING, TABFOOTING, SUBHEAD, or SUBFOOT. For details, see [Identifying a Heading or Footing](#).

line_#

Identifies a line by its position in the heading or footing. You need to include the LINE attribute only if you have a multi-line heading or footing.

TEXT

Formats only text strings and Dialogue Manager variables (also known as &variables). It is not necessary to use OBJECT=TEXT in your declaration unless you are styling both text strings and embedded fields in the same heading or footing.

item_#

Identifies an item by its position in a line.

If you need to apply formatting to several parts of a continuous text string that appears on one line, you can break the header or footer into multiple parts using spot markers. Place the spot marker after the text string you wish to specify. The <+0> spot marker will not add any additional spaces to your heading or footing. When using spot markers, text is divided as follows:

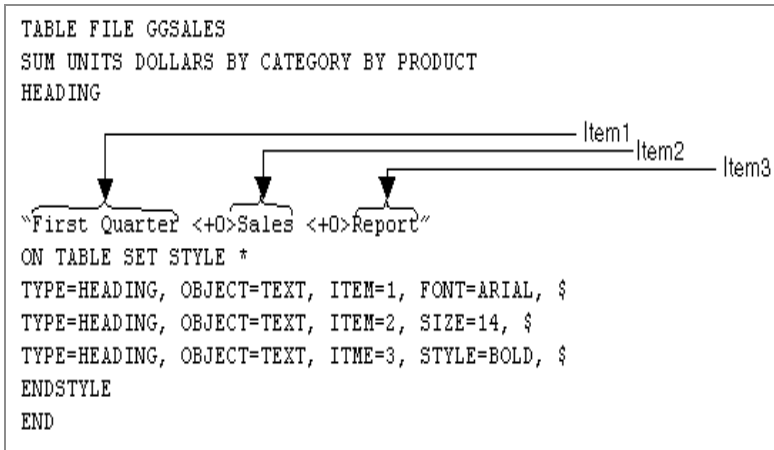

For an example, see [Identify a Text String in a Heading or Footing](#).

The position value also depends on whether you are using the OBJECT attribute or not. If you are using:

- OBJECT=TEXT, count only text strings from left to right.
- No OBJECT, count text strings and embedded field values from left to right.

Identifying a Text String in a Heading Using Spot Markers

The following illustrates how to apply different formats to text strings in a heading using spot markers. The spot markers used in this example are <+0>, since they do not add any spaces. The relevant StyleSheet declarations are highlighted in the request.

```

TABLE FILE CENTORD
HEADING
"Third Quarter,<+0>2002:<+0> Sales Quantity Analysis"
SUM QUANTITY BY PLANT
ON TABLE SET PAGE-NUM OFF
ON TABLE HOLD FORMAT HTML

```

```

ON TABLE SET STYLE *
TYPE=REPORT, GRID=OFF, $
TYPE=HEADING, OBJECT=TEXT, ITEM=1, STYLE=BOLD+UNDERLINE, SIZE=12, $
TYPE=HEADING, OBJECT=TEXT, ITEM=2, COLOR=BLUE, SIZE=12,
    STYLE=BOLD+UNDERLINE, $
TYPE=HEADING, OBJECT=TEXT, ITEM=3, STYLE=ITALIC,$
ENDSTYLE
END

```

The output is:

<u>Third Quarter, 2002:</u> <i>Sales Quantity Analysis</i>	
<u>Plant</u>	<u>Quantity</u>
Manufacturing	
BOS	1,033,818
DAL	390,844
LA	229,256
ORL	386,909
SEA	86,680
STL	776,743

Identify an Embedded Field in a Heading or Footing

```
TYPE=type, [LINE=line_#], OBJECT=FIELD, [ITEM=item #]
```

where:

type

Identifies a type of heading or footing. Select from HEADING, FOOTING, TABHEADING, TABFOOTING, SUBHEAD, or SUBFOOT. For details, see [Identifying a Heading or Footing](#).

line_#

Identifies a line by its position in the heading or footing. You need to include the LINE attribute only if you have a multi-line heading or footing.

item_#

Identifies an item by its position in a line.

If you have more than one embedded field in a heading or footing, you must specify the field you wish to format by giving the item number. Count items from left to right. Do not include text fields in the count. You do not need to specify the item number if there is only one embedded field in the heading or footing.

Identifying Embedded Fields in a Heading

The following illustrates how to format an embedded field in a heading. Notice that the item number is not specified in the StyleSheet declaration since there is only one embedded field in the heading. The relevant StyleSheet declaration is highlighted in the request.

```
TABLE FILE CENTORD
HEADING
"Sales For <YEAR By Plant"
SUM QUANTITY BY PLANT
WHERE YEAR EQ 2000
ON TABLE SET PAGE-NUM OFF
ON TABLE HOLD FORMAT HTML
ON TABLE SET STYLE *
TYPE=REPORT, GRID=OFF, $
TYPE=HEADING, OBJECT=TEXT, COLOR=BLUE,$
TYPE=HEADING, OBJECT=FIELD, COLOR=RED, STYLE=BOLD,$
ENDSTYLE
END
```

The output is:

Sales For 2000 By Plant	
Manufacturing	
<u>Plant</u>	<u>Quantity</u>
BOS	3,902
DAL	1,122
LA	5
STL	2,019

Insert the Total Page Count

To insert the total number of pages, add the following to your request:

```
<TABLASTPAGE
```

Note that TABLASTPAGE is not supported with Excel 2000.

**Note:**

- TABLASTPAGE does not adjust for changes in FOCFIRSTPAGE or for the REPAGE command. For example, if the report has 10 pages and the user uses FOCFIRSTPAGE to set the first page number to 3 rather than 1, the value of TABLASTPAGE will still be 10.
- TABLASTPAGE is supported only for a single report, not compound reports. A separate page count is generated for each report in a compound report.
- TABLASTPAGE is supported only for styled reports such as HTML, PDF, and PS. It is not supported for EXL2K, WP, or DOC.
- TABLASTPAGE causes a second pass through the report results, first to calculate the last page then to print it with TABPAGENO (even when SQUEEZE=OFF).
- TABLASTPAGE does not support the system (external) sort.
- GRAPH FILE does not support TABLASTPAGE.
- TABLEF is not supported with TABLASTPAGE.
- The variables TABPAGENO and TABLASTPAGE cannot be used to define styling with conditional styling (WHEN).

Inserting the Current Page Number and the Total Page Count

The following illustrates how to add the current page number and the total page count to a report. The relevant syntax is highlighted in the request.

```

TABLE FILE EMPLOYEE
PRINT EMP_ID AS 'Employee ID'
BY SALARY IN-GROUPS-OF 5000 AS 'Salary'
BY PCT_INC AS 'Percent,Increase'
BY DAT_INC AS 'Date of,Increase'
ON SALARY PAGE-BREAK
ON TABLE SET PAGE-NUM OFF
ON TABLE HOLD FORMAT HTML
ON TABLE SET STYLE *
TYPE=REPORT, GRID=OFF, $
TYPE=TITLE, STYLE=BOLD, SIZE=11, $
ENDSTYLE
FOOTING
"Page <TABPAGENO of <TABLASTPAGE"
END

```

The first two pages of output are:

<u>Salary</u>	<u>Percent Increase</u>	<u>Date of Increase</u>	<u>Employee ID</u>
\$5,000.00	.00	82/01/04	119265415
		82/04/01	543729165
	.04	82/06/11	543729165
	.05	82/05/14	119265415
Page 1 of 5			
<u>Salary</u>	<u>Percent Increase</u>	<u>Date of Increase</u>	<u>Employee ID</u>
\$10,000.00	.10	82/01/01	071382660
			112847612
	.12	81/01/01	071382660
Page 2 of 5			

Display the Total Number of Pages Within Each Sort Group

The request must have the following syntax and hold the output in a styled output format:

```
BY sortfield REPAGE
```

The heading or footing can use the following syntax to display “Page *x* of *y*”

```
{HEADING|FOOTING}
"Page <TABPAGENO of <BYLASTPAGE"
```

where:

sortfield

Is the sort field that has the REPAGE option. A PAGE-BREAK is required on the same sort field or a lower level sort field. PAGE-BREAK starts a new page for each sort break. REPAGE resets the page number to 1 for each sort break.

<TABPAGENO

Is the current page number.

<BYLASTPAGE

Is the last page number before the repage.

Paginating Within a Sort Group

The following request against the GGSALES data source sorts by product, region, category, and city. It resets the pagination each time the product changes. The heading prints the current page number and the total within each product group:

```
TABLE FILE GGSALES
HEADING CENTER
"<PRODUCT : Page <TABPAGENO of <BYLASTPAGE "

SUM UNITS
BY PRODUCT NOPRINT REPAGE
```

```

BY REGION PAGE-BREAK
BY CATEGORY
BY CITY
ON TABLE HOLD FORMAT PDF
END

```

The following partial output shows that the page number resets to 1 when the product changes and that the BYLASTPAGE variable displays the total number of pages for each product:

Biscotti : Page 1 of 4			
<u>Region</u>	<u>Category</u>	<u>City</u>	<u>Unit Sales</u>
Midwest	Food	Chicago	29413
		Houston	27504
		St. Louis	29188

Biscotti : Page 2 of 4			
<u>Region</u>	<u>Category</u>	<u>City</u>	<u>Unit Sales</u>
Northeast	Food	Boston	47064
		New Haven	46214
		New York	51964

Biscotti : Page 3 of 4			
<u>Region</u>	<u>Category</u>	<u>City</u>	<u>Unit Sales</u>
Southeast	Food	Atlanta	43639
		Memphis	35349
		Orlando	40606

Biscotti : Page 4 of 4			
<u>Region</u>	<u>Category</u>	<u>City</u>	<u>Unit Sales</u>
West	Food	Los Angeles	20773
		San Francisco	22987
		Seattle	26676

Capuccino : Page 1 of 3			
<u>Region</u>	<u>Category</u>	<u>City</u>	<u>Unit Sales</u>
Northeast	Coffee	Boston	15358
		New Haven	12386
		New York	17041

Identifying a Page Number, Underline, or Skipped Line

In a report, you can identify and format page numbers, underlines, and skipped lines using the PAGENUM, SKIPLINE, and UNDERLINE attributes.

You can make a detailed tabular report easier to read by separating sections with blank lines or underlines.

You cannot add blank lines or underlines to an HTML report that displays a grid. You can add blank lines or underlines if you set the GRID attribute to OFF.

When inserting blank lines, the setting of the LINES parameter should be at least one less than the setting of the PAPER parameter, to allow room for blanks after the display of data on a page.

Note that although you can insert skipped lines and underlines in an HTML report, formatting is not supported.

The following illustrates where the PAGENUM, UNDERLINE, and SKIPLINE components appear in a report, and which TYPE values you use to identify them.

```

TABLE FILE CENTORD
HEADING
"Sales By Plant"
SUM QUANTITY
BY PLANT BY YEAR
WHERE PLANT EQ 'BOS' OR 'DAL'
ON YEAR UNDER-LINE
ON PLANT SKIP-LINE
ON TABLE HOLD FORMAT PDF
END

```

TYPE=PAGENUM → PAGE 1			
Sales By Plant			
	<u>Manufacturing Plant</u>	<u>Year</u>	<u>Quantity</u>
TYPE=UNDERLINE →	BOS	1999	262,167
		2000	438,155
		2001	479,319
		2002	491,080
TYPE=SKIPLINE →	DAL	1999	94,611
		2000	162,290
		2001	171,346
		2002	184,385

i Note: Since this request simply illustrates where the components appear in a report, it omits a StyleSheet.

Identify a Page Number, Underline, or Skipped Line

TYPE=type

where:

type

Identifies the report component. Select from:

PAGENUM which identifies page numbers. Note that the TABPAGENO variable is a component of the heading or footing in which it appears and can be formatted as a subcomponent of that heading or footing.

SKIPLINE which denotes skipped lines generated by the ON *field* SKIP-LINE. This is not supported for reports in HTML format.

UNDERLINE which identifies underlines generated by ON *field* UNDER-LINE, or by BAR in a Financial Modeling Language (FML) report. This is not supported for reports in HTML format.

Identifying Underlines and Page Numbers

The following illustrates how to identify underlines and page numbers in a report request. The relevant StyleSheet declarations appear in boldface in the request.

Note that this report is formatted in PDF, since formatting is not supported for underlines in an HTML report.

```
TABLE FILE CENTORD
HEADING
"Sales By Plant"
SUM QUANTITY
BY PLANT BY YEAR
WHERE PLANT EQ 'BOS' OR 'DAL' OR 'LA'
ON PLANT UNDER-LINE SKIP-LINE
ON TABLE HOLD FORMAT PDF
ON TABLE SET STYLE *
TYPE=REPORT, GRID=OFF, $
TYPE=HEADING, OBJECT=TEXT, COLOR=BLUE, FONT=ARIAL,$
TYPE=PAGENUM, STYLE=ITALIC, SIZE=8,$
TYPE=UNDERLINE, COLOR=RED,$
ENDSTYLE
END
```

The output is:

PAGE I		
Sales By Plant		
Manufacturing Plant	YEAR	Quantity:
BOS	2000	3,902
	2001	491,080
	2002	538,836
DAL	2000	1,122
	2001	185,785
	2002	203,937
LA	2000	5
	2001	109,326
	2002	119,925

Identifying Skipped Lines

The following illustrates how to identify skipped lines in a report. The relevant StyleSheet declaration is highlighted in the request.

```
TABLE FILE CENTINV
HEADING
"Low Stock Report"
" "
SUM QTY_IN_STOCK
WHERE QTY_IN_STOCK LT 5000
BY PRODNAME
ON PRODNAME SKIP-LINE
ON TABLE SET PAGE-NUM OFF
ON TABLE HOLD FORMAT PDF
ON TABLE SET STYLE *
TYPE=SKIPLINE, BACKCOLOR=SILVER, $
ENDSTYLE
END
```

The output is:

Low Stock Report	
<u>Product Name:</u>	<u>Quantity In Stock:</u>
DVD Upgrade Unit for Cent. VCR	199
R5 Micro Digital Tape Recorder	1990
110 VHS-C Camcorder 20 X	4000
120 VHS-C Camcorder 40 X	2300
340SX Digital Camera 65K P	990
650DL Digital Camcorder 150 X	2972

Extend an Underline to the Entire Report Column

By default, underlines for column titles on a report extend only from the beginning to the end of the column title text. You can extend the underline to the entire report column in styled report output using the EXTUNDERLINE option in your FOCUS StyleSheet. EXTUNDERLINE is an option of the STYLE attribute for the TITLE report component. It is supported for formats DHTML, PDF, PS, and PPT.

```
TYPE = TITLE, [COLUMN = colspec,] STYLE = [+|-]EXTUNDERLINE , $
```

where:

colspec

Is any valid column specification.

+EXTUNDERLINE

Adds the EXTUNDERLINE option to the inherited text style or specifies a combination of text styles (for example, STYLE=BOLD+UNDERLINE).

-EXTUNDERLINE

Removes the EXTUNDERLINE option from the inherited text style.

Usage Notes for the EXTUNDERLINE Attribute

- HTML format is not supported because the browser calculates the column width and renders the report.
- GRID=ON and EXTUNDERLINE are mutually exclusive since the GRID line spans the width of the column. GRID overrides any styling specified for the column title underline.

Extending an Underline to the Entire Report Column

The following request from the GGSALES data source sums dollar sales by city and by date:

```
DEFINE FILE GGSALES
YEAR/YY = DATE;
MONTH/M = DATE;
END
TABLE FILE GGSALES
SUM DOLLARS
BY DATE
BY CITY
WHERE YEAR EQ 1997
WHERE MONTH FROM 01 TO 05
WHERE CITY EQ 'Seattle' OR 'San Francisco' OR 'Los Angeles'
ON TABLE SET PAGE NOPAGE
ON TABLE HOLD FORMAT DHTML
END
```

The output shows that only the column titles are underlined:

<u>Date</u>	<u>City</u>	<u>Sales</u>
1997/01/01	Los Angeles	159935
	San Francisco	162712
	Seattle	159804
1997/02/01	Los Angeles	148915
	San Francisco	143987
	Seattle	132505
1997/03/01	Los Angeles	165902
	San Francisco	145129
	Seattle	165847
1997/04/01	Los Angeles	146106
	San Francisco	158799
	Seattle	144169
1997/05/01	Los Angeles	178336
	San Francisco	144534
	Seattle	190208

To underline entire columns, generate the output in a format that can be styled and use the EXTUNDERLINE option in the STYLE attribute for the TITLE component. For example, the following request creates DHTML output in which the column titles are in boldface and left justified, and the underline is extended to the entire report columns:

```

DEFINE FILE GGSALLES
YEAR/YY = DATE;
MONTH/M = DATE;
END
TABLE FILE GGSALLES
SUM DOLLARS
BY DATE
BY CITY
WHERE YEAR EQ 1997
WHERE MONTH FROM 01 TO 05
WHERE CITY EQ 'Seattle' OR 'San Francisco' OR 'Los Angeles'
ON TABLE SET PAGE NOPAGE
ON TABLE HOLD FORMAT DHTML
ON TABLE SET STYLE *
TYPE=TITLE, STYLE= BOLD +EXTUNDERLINE, JUSTIFY=LEFT $
ENDSTYLE
END

```

The output is:

Date	City	Sales
1997/01/01	Los Angeles	159935
	San Francisco	162712
	Seattle	159804
1997/02/01	Los Angeles	148915
	San Francisco	143987
	Seattle	132505
1997/03/01	Los Angeles	165902
	San Francisco	145129
	Seattle	165847
1997/04/01	Los Angeles	146106
	San Francisco	158799
	Seattle	144169
1997/05/01	Los Angeles	178336
	San Francisco	144534
	Seattle	190208

The following version of the request makes the EXTUNDERLINE and JUSTIFY=LEFT options the default for the TITLE component, then makes the Date column title bold and removes the extended underline from that column:

```

DEFINE FILE GGSales
YEAR/YY = DATE;
MONTH/M = DATE;
END
TABLE FILE GGSales
SUM DOLLARS AS 'Sales'
BY DATE
BY CITY
WHERE YEAR EQ 1997
WHERE MONTH FROM 01 TO 05
WHERE CITY EQ 'Seattle' OR 'San Francisco' OR 'Los Angeles'
ON TABLE SET PAGE NOPAGE
ON TABLE HOLD FORMAT DHTML
ON TABLE SET STYLE *
TYPE=TITLE,STYLE= EXTUNDERLINE, JUSTIFY=LEFT ,$
TYPE=TITLE,COLUMN= DATE, STYLE= -EXTUNDERLINE +BOLD ,$
ENDSTYLE
END

```

The output is:

<u>Date</u>	<u>City</u>	<u>Sales</u>
1997/01/01	Los Angeles	159935
	San Francisco	162712
	Seattle	159804
1997/02/01	Los Angeles	148915
	San Francisco	143987
	Seattle	132505
1997/03/01	Los Angeles	165902
	San Francisco	145129
	Seattle	165847
1997/04/01	Los Angeles	146106
	San Francisco	158799
	Seattle	144169
1997/05/01	Los Angeles	178336
	San Francisco	144534
	Seattle	190208

Section Separation Features

Feature	Description	Applies to
SKIP-LINE	Adds a blank line.	HTML (requires GRID=OFF) PDF PS
TYPE=SKIPLINE	Formats a blank line.	PDF PS
UNDER-LINE	Underlines a sort group.	HTML (requires GRID=OFF) PDF PS
TYPE=UNDERLINE	Formats an underline.	PDF PS

Feature	Description	Applies to
<code>STYLE={+ -}UNDERLINE</code>	Adds an underline to a report component, or removes an underline from a report component other than a column title.	HTML PDF PS
<code>BAR AS '{- =}'</code>	Selects a light or heavy underline in an FML report.	HTML PDF (displays single or double underline)

Format a Blank Line

```
TYPE=SKIPLINE, attribute=value, $
```

where:

attribute

Is a valid StyleSheet attribute.

value

Is the value of the attribute.

i **Note:** This option is supported for PDF, PS, and HTML reports (when used in conjunction with internal cascading style sheets).

Format an Underline

```
TYPE=UNDERLINE ... COLOR={color|RGB} (r g b), $
```

where:

UNDERLINE

Denotes underlines generated by ON *fieldname* UNDER-LINE.

COLOR

Specifies the color of the underline. If the display or output device does not support colors, it substitutes shades of gray. The default value is black.

color

Is one of the supported color values.

RGB

Specifies the text color using a mixture of red, green, and blue.

(r g b)

Is the desired intensity of red, green, and blue, respectively. The values are on a scale of 0 to 255, where 0 is the least intense and 255 is the most intense.

Note that using the three-color components in equal intensities results in shades of gray. For more information, see [Color Values in a Report](#).



Note: This option is supported for PDF, PS, and HTML reports (when used in conjunction with internal cascading style sheets).

Formatting a Sort Group Underline

This request uses UNDERLINE to change the default color of an underline from black to red.

```
TABLE FILE GGSALES
SUM UNITS DOLLARS
BY CATEGORY BY PRODUCT
HEADING
"Sales Report"
" "
ON CATEGORY UNDER-LINE
ON TABLE SET PAGE-NUM OFF
ON TABLE HOLD FORMAT PDF
ON TABLE SET STYLE *
```

```
TYPE=UNDERLINE, COLOR=RED, $
ENDSTYLE
END
```

The result is an eye-catching separation between sort group values. The online PDF report appears as:

Sales Report			
<u>Category</u>	<u>Product</u>	<u>Unit Sales</u>	<u>Dollar Sales</u>
Coffee	Capuccino	189217	2381590
	Espresso	308986	3906243
	Latte	878063	10943622
Food	Biscotti	421377	5263317
	Croissant	630054	7749902
	Scone	333414	4216114
Gifts	Coffee Grinder	186534	2337567
	Coffee Pot	190695	2449585
	Mug	360570	4522521
	Thermos	190081	2385829

Add or Remove a Report Component Underline

```
TYPE=type, [subtype,] STYLE=[+|-]UNDERLINE, $
```

where:

type

Is the report component.

subtype

Are additional attributes, such as COLUMN, ACROSS, or ITEM, needed to identify the report component.

+

Adds an underline to the inherited text style or specifies a combination of text styles (for example, STYLE=BOLD+UNDERLINE). + is the default value.

-

Removes an underline from an inherited text style.

For more information, see [Identifying Report Components](#).

Remove an Underline From a Column Title

This syntax applies to an HTML report with an internal cascading style sheet.

```
TYPE=TITLE, [COLUMN=column,] STYLE=-UNDERLINE, $
```

where:

COLUMN=column

Specifies a column.

Adding Column Underlines and Removing Column Title Underlines

This request adds underlines to the values of the column CATEGORY and removes the default underlines from the column titles in an HTML report with an internal cascading style sheet.

```
SET HTMLCSS = ON
TABLE FILE MOVIES
PRINT TITLE DIRECTOR
BY CATEGORY
ON TABLE SET PAGE-NUM OFF
ON TABLE HOLD FORMAT HTML
ON TABLE SET STYLE *
TYPE=REPORT, GRID=OFF, $
TYPE=TITLE, STYLE=-UNDERLINE, $
TYPE=REPORT, COLUMN=CATEGORY, STYLE=UNDERLINE, $
```

ENDSTYLE
END

The partial report is:

CATEGORY	TITLE	DIRECTOR
<u>ACTION</u>	JAWS	SPIELBERG S.
	ROBOCOP	VERHOVEN P.
	TOTAL RECALL	VERHOVEN P.
	TOP GUN	SCOTT T.
	RAMBO III	MCDONALD P.
<u>CHILDREN</u>	SMURFS, THE	
	SHAGGY DOG, THE	BARTON C.
	SCOOBY-DOO-A DOG IN THE RUFF	
	ALICE IN WONDERLAND	GEROMINI
	SESAME STREET-BEDTIME STORIES AND SONGS	
	ROMPER ROOM-ASK MISS MOLLY	
	SLEEPING BEAUTY	DISNEY W.
BAMBI	DISNEY W.	
<u>CLASSIC</u>	EAST OF EDEN	KAZAN E.
	CITIZEN KANE	WELLES O.
	CYRANO DE BERGERAC	GORDON M.
	MARTY	MANN D.
	MALTESE FALCON, THE	HUSTON J.
	GONE WITH THE WIND	FLEMING V.

Reusing FOCUS StyleSheet Declarations With Macros

If you frequently use a group of attributes within a StyleSheet declaration, you can create a StyleSheet macro that groups the sequence of attributes together, enabling you to apply them repeatedly throughout the StyleSheet without recoding them.

Defining a FOCUS StyleSheet Macro

A StyleSheet macro must be defined in the StyleSheet that references it, and the macro definition must precede its use in the StyleSheet.

To define a macro, use the DEFMACRO attribute followed by the desired styling attributes.

Define a FOCUS StyleSheet Macro

```
DEFMACRO = macroname, attribute1 = value1, [attribute2 = value2,]... $
```

where:

macroname

Is the name you assign to the macro you are creating.

attribute

Is any StyleSheet attribute, such as an attribute to format a report component, insert a graphic, or apply a condition for conditional formatting (WHEN).

value

Is the value you want to assign to the attribute.

Applying a FOCUS StyleSheet Macro

A StyleSheet macro applies all the formatting defined in the macro to the report component specified in the declaration. To apply a macro, use the MACRO attribute. You can apply one macro per declaration.

When applying a StyleSheet macro to a report component, you can override any attribute defined in the macro by specifying the same attribute with the new value in that declaration, following the MACRO attribute.

Apply a FOCUS StyleSheet Macro

```
TYPE=type, [subtype,] MACRO=macroname, [condition,] $
```

where:

type

Is the report component you wish to affect.

subtype

Is any additional attribute, such as COLUMN, ACROSS, or ITEM, that is needed to identify the report component to which you are applying the macro. See [Identifying Report Components](#), for information about how to specify different types of report components.

macroname

Is the name of the macro to apply to the specified report component. The macro must be defined in the same StyleSheet.

condition

Is an optional WHEN attribute that you can specify to make this declaration conditional.

Defining, Applying, and Overriding a FOCUS StyleSheet Macro

The following annotated example illustrates how to define, apply, and override macros in your StyleSheet:

```
TABLE FILE GGSales
SUM UNITS DOLLARS
BY CATEGORY BY PRODUCT
HEADING
"Sales Report"
FOOTING
"Sales Report - Page <TABPAGENO>"
ON TABLE HOLD FORMAT HTML
ON TABLE SET STYLE *
```

```

TYPE=REPORT, GRID=OFF,$
1.  DEFMACRO=A, STYLE=BOLD, SIZE=12, $
2.  DEFMACRO=BI, STYLE=BOLD+ITALIC, COLOR=PURPLE, $
3.  TYPE=HEADING, MACRO=A, $
4.  TYPE=FOOTING, MACRO=BI, COLOR=BLACK, $
5.  TYPE=DATA, COLUMN=N1, MACRO=BI, $
    ENDSTYLE
END

```

1. Defines the A macro.
2. Defines the BI macro.
3. Illustrates how the A macro is applied to the heading.
4. Illustrates how the BI macro is applied to the footing and is partially overridden by the attribute value pair COLOR=BLACK.
5. Illustrates how the BI macro is applied to the data in the BY sort field CATEGORY (specified by TYPE=DATA, COLUMN=N1).

The output is:

Sales Report			
<u>Category</u>	<u>Product</u>	<u>Unit Sales</u>	<u>Dollar Sales</u>
<i>Coffee</i>	Capuccino	189217	2381590
	Espresso	308986	3906243
	Latte	878063	10943622
<i>Food</i>	Biscotti	421377	5263317
	Croissant	630054	7749902
	Scone	333414	4216114
<i>Gifts</i>	Coffee Grinder	186534	2337567
	Coffee Pot	190695	2449585
	Mug	360570	4522521
	Thermos	190081	2385829

Sales Report - Page 1

FOCUS StyleSheet Attribute Inheritance

Each report component inherits StyleSheet attributes from its parent component. You can override an inherited attribute by explicitly specifying the same attribute with a different value in the child component's declaration. Since each component inherits automatically, you need specify only those attributes that differ from, or that augment, a component's inherited attributes.

Inheritance enables you to define common formatting in a single declaration, and to apply it automatically to all child components, except for those components for which you specify different attribute values to override the inherited values. You benefit from less coding and a more concise StyleSheet.

For example, you could specify that all report titles should be blue and bold:

```
TYPE=TITLE, COLOR=BLUE, STYLE=BOLD, $
```

Each column title will inherit this formatting, appearing in blue and bold by default. However, you can choose to format one column differently, allowing it to inherit the blue color, but specifying that it override the bold style and that it adds a yellow background color:

```
TYPE=TITLE, COLUMN=N2, STYLE=-BOLD, BACKCOLOR=YELLOW, $
```

FOCUS StyleSheet Inheritance Hierarchy

Report components inherit StyleSheet attributes according to a hierarchy. The root of the hierarchy is the entire report, specified in a StyleSheet declaration by `TYPE=REPORT`. (Declarations that omit `TYPE` default to `TYPE=REPORT`, and so are also applied to the entire report.) Attributes that are unspecified for the entire report default to values that are determined according to the report's display format, such as HTML or PDF.

Each report component inherits from its parent component. Component X is a parent of component Y if X is specified by a subset of all the "type" attributes that specify Y, and if those shared type attributes have the same values. For example,

- A component specified by `TYPE=x, subtype=y, elementtype=z` is a child of the component specified by `TYPE=x, subtype=y` and inherits attributes from it.

- The component specified by `TYPE=x, subtype=y` is a child of the component specified by `TYPE=x`, and inherits from it.
- The component specified by `TYPE=x`, where `x` is any value other than `REPORT`, is a child of the entire report (`TYPE=REPORT`) and inherits from it.

When you use an external cascading style sheet (CSS), a report component inherits formatting from parent HTML elements, not from a parent report component.

Augmenting Inherited FOCUS StyleSheet Attributes

The following illustrates how to augment inherited StyleSheet attributes. The StyleSheet declarations discussed in this example are highlighted in the report request.

The page heading in this report has two lines. The first StyleSheet declaration identifies the report component `HEADING` to be formatted in bold and have a 12-point font size. This will format both lines of the heading with these styles.

To augment the format for the second line of the heading, a second declaration has been added that specifies the heading line number and the additional style characteristic. In this case we have added the declaration `TYPE=HEADING, LINE=2, STYLE=ITALIC`. The second line of the heading will inherit the bold style and 12-point font size from the first `HEADING` declaration, and will also receive the italic style defined in the second declaration.

```
TABLE FILE GGSALES
SUM UNITS DOLLARS
BY CATEGORY BY PRODUCT
HEADING
"Sales Report:"
"First Quarter"
ON TABLE HOLD FORMAT HTML
ON TABLE SET PAGE-NUM OFF
ON TABLE SET STYLE *
TYPE=REPORT, GRID=OFF, $
TYPE=HEADING, STYLE=BOLD, SIZE=12, $
TYPE=HEADING, LINE=2, STYLE=ITALIC, $
ENDSTYLE
END
```

The output is:

Sales Report:			
<i>First Quarter</i>			
<u>Category</u>	<u>Product</u>	<u>Unit Sales</u>	<u>Dollar Sales</u>
Coffee	Capuccino	189217	2381590
	Espresso	308986	3906243
	Latte	878063	10943622
Food	Biscotti	421377	5263317
	Croissant	630054	7749902
	Scone	333414	4216114
Gifts	Coffee Grinder	186534	2337567
	Coffee Pot	190695	2449585
	Mug	360570	4522521
	Thermos	190081	2385829

Overriding Inherited FOCUS StyleSheet Attributes

The following illustrates how to override StyleSheet inheritance. The StyleSheet declarations discussed in this example are highlighted in the report request.

```

TABLE FILE GGSales
HEADING
"Sales Report"
SUM UNITS DOLLARS
BY CATEGORY BY PRODUCT BY DATE NOPRINT
WHERE DATE GE 19960101 AND DATE LE 19960401
ON TABLE SET STYLEMODE PAGED
ON TABLE SET LINES 20
ON TABLE HOLD FORMAT HTML
FOOTING
"Page <TABPAGE NO of <TABLASTPAGE"
ON TABLE SET STYLE *
TYPE=REPORT, GRID=OFF, $
1. TYPE=REPORT, BACKCOLOR=BLUE, COLOR=WHITE, $
2. TYPE=HEADING, BACKCOLOR=WHITE, COLOR=BLACK, STYLE=BOLD, SIZE=12, $
3. TYPE=FOOTING, SIZE=11, STYLE=BOLD+ITALIC, BACKCOLOR=WHITE,
   COLOR=BLACK, $
4. TYPE=FOOTING, OBJECT=FIELD, ITEM=1, STYLE=-ITALIC, $
ENDSTYLE
END

```

1. Formats the entire report (all components) to appear with a blue background and white font.
2. Overrides the inherited format for the page heading (defined in the TYPE=REPORT declaration) by specifying the background color as white and the font as black.
3. Formats the page footing as font size 11 with a bold and italic style, and overrides the report color by specifying BACKCOLOR=WHITE and COLOR=BLACK.
4. Since the <TABPAGE NO system variable is part of the page footing, it inherits all of the formatting specified in the first TYPE=FOOTING declaration. This declaration overrides the inherited format for the page footing by specifying OBJECT=FIELD, ITEM=1, and removing the italic style (STYLE=-ITALIC). Note that ITEM=1 needs to be specified, since there are two embedded fields in the footing.

The output is:

Sales Report			
<u>Category</u>	<u>Product</u>	<u>Unit Sales</u>	<u>Dollar Sales</u>
Coffee	Capuccino	5507	71728
		5219	67429
		6343	87290
		4170	58692
	Espresso	14499	182900
		14015	169023
		14871	184474
		11613	156396
	Latte	31469	401873
		38725	490645
		42717	520948
		36374	468137

Page 1 of 4

Conditionally Formatting in a StyleSheet

You can conditionally format report components or display a graphic in your report based on the values in your report. Using conditional styling, you can:

- Draw attention to particular items in the report.
- Emphasize differences between significant values.
- Customize the resources to which an end user navigates from different parts of the report.

To conditionally format reports, add the `WHEN` attribute to a `StyleSheet` declaration. The `WHEN` attribute specifies a condition that is evaluated for each instance of a report component (that is, for each cell of a tabular report column or each free-form report page). The `StyleSheet` declaration is applied to each instance that satisfies the condition, and is ignored by each instance that fails to satisfy the condition.

You can also apply sequential conditional formatting.

i Note: The variables `TABPAGENO` and `TABLASTPAGE` cannot be used to define styling with conditional styling (`WHEN`).

Applying Sequential Conditional Formatting

You can apply sequential conditional logic to a report component by creating a series of declarations, each with a different condition. This is the `StyleSheet` equivalent of a sequence of nested `IF-THEN-ELSE` statements. When several conditional declarations specify the same report component (for example, the same column) and evaluate the same field in the condition, they are processed together as a group. For each instance of the report component (for example, for each cell of a column):

1. The conditional declarations in the *group* are evaluated, in the order in which they are found in the `StyleSheet`, until one of the conditions is satisfied. That declaration is then applied to that instance of the report component. The other conditional declarations in the *group*, and any non-conditional declarations that specify the same report component and the same attributes, are ignored for that instance.
2. If, however, none of the conditional declarations have been satisfied for that instance, then the first unconditional declaration for that report component that specifies the same attribute(s) is applied to that instance.
3. Any unconditional declarations for that report component that specify other attributes (that is, attributes that have not already been applied to the instance in Steps 1 or 2), are now applied to the instance.

4. The entire process is repeated for the next instance of the report component (for example, for the next cell of the column).

Conditionally Format in a StyleSheet

```
TYPE=type, [subtype,] attributes, WHEN=field1 operator {field2|value}, $
```

OR

```
TYPE=type, [subtype,] attributes, WHEN=FORECAST, $
```

where:

type

Is the value of the TYPE attribute. You can specify any report component.

subtype

Are any additional attributes, such as COLUMN, ACROSS, or ITEM, that are needed to identify the report component to which you are applying the declaration.

attributes

Are the attributes in the StyleSheet declaration that are made conditional by the WHEN attribute. They can include most formatting or graphic image attributes.

field1, field2

Identifies the report fields that are being compared. Each one can be:

- The name of a display field or vertical sort field in a tabular report. You cannot specify a horizontal sort field (ACROSS).
- A column reference in a report.
- The name of an embedded field in the heading or footing of a free-form report.

If you wish to use a field that you do not want to display in the report, you can specify the field in the report request, and use the NOPRINT option to prevent the field from being displayed (for example, PRINT *fieldname* NOPRINT).

To apply a prefix operator to a field in a report, you can:

- Use the same prefix operator in the WHEN attribute. You must refer to the field by name in the WHEN attribute (for example, WHEN=AVE.PRICE GT 300).
- Refer to the field in the WHEN attribute by column position and omit the prefix operator (for example, WHEN=N3 GT 300). This is not supported for the ST. and CT. prefix operators.

The field cannot be a packed (P) numeric field.

operator

Defines how the condition is satisfied. You can use these relational operators:

EQ where the condition is satisfied if the values on the left and right are equal. If the values being compared are alphanumeric, their case (uppercase, lowercase, or mixed case) must match.

NE where the condition is satisfied if the values on the left and right are not equal.

LT where the condition is satisfied if the value on the left is less than the value on the right.

LE where the condition is satisfied if the value on the left is less than or equal to the value on the right.

GT where the condition is satisfied if the value on the left is greater than the value on the right.

GE where the condition is satisfied if the value on the left is greater than or equal to the value on the right.

value

Is a constant, such as a number, character string, date, or date-time. You must enclose non-numeric constants, such as character strings and dates, in single quotation marks.

Although you cannot use functions or operators here to specify the value, you can define a temporary field (COMPUTE or DEFINE) using functions and operators, use the temporary field in the report, and specify it here instead of a constant.

FORECAST

Identifies fields that are generated using the FORECAST command.

Applying Basic Conditional Formatting

This example illustrates how to apply conditional formatting to a report. The conditional formatting draws attention to orders that total more than \$200,000.

Notice that because a particular column is not specified in the declaration, the formatting is applied to the entire row.

```
TABLE FILE CENTORD
HEADING
"Order Revenue"
" "
SUM ORDER_DATE LINEPRICE AS 'Order,Total:'
BY HIGHEST 10 ORDER_NUM
ON TABLE SET PAGE-NUM OFF
ON TABLE HOLD FORMAT HTML
ON TABLE SET STYLESHEET *
TYPE=REPORT, GRID=OFF, $
TYPE=DATA, BACKCOLOR=AQUA, STYLE=BOLD, WHEN=LINEPRICE GT 200000, $
TYPE=HEADING, FONT='Arial', STYLE=BOLD, SIZE=11, $
ENDSTYLE
END
```

The output is:

Order Revenue		
<u>Order</u> <u>Number:</u>	<u>Date</u> <u>Of Order:</u>	<u>Order</u> <u>Total:</u>
94710	2001/01/02	\$406,964.24
94680	2001/01/02	\$421,916.60
94670	2001/01/02	\$513,868.76
94550	2001/01/02	\$496,323.64
94530	2001/01/02	\$3,472.41
94520	2001/01/02	\$261,808.72
94490	2000/12/31	\$633,723.06
94460	2001/01/02	\$3,872.39
94430	2001/01/02	\$3,033.38
94410	2001/01/02	\$2,337.28

Applying Conditional Formatting to a Column

This example illustrates how you can use conditional formatting to draw attention to columns that are not specified in the condition. The WHEN condition states that the order number for orders exceeding \$200,000 should display in boldface with an aqua background.

Notice that the column that is evaluated in the WHEN condition (LINEPRICE) is different from the column that is formatted (ORDER_NUM); they do not need to be the same.

```
TABLE FILE CENTORD
HEADING
"Order Revenue"
" "
SUM ORDER_DATE LINEPRICE AS 'Order,Total:'
BY HIGHEST 10 ORDER_NUM
ON TABLE SET PAGE-NUM OFF
ON TABLE HOLD FORMAT HTML
ON TABLE SET STYLESHEET *
TYPE=REPORT, GRID=OFF, $
TYPE=DATA, COLUMN=ORDER_NUM,
BACKCOLOR=AQUA, STYLE=BOLD, WHEN=LINEPRICE GT 200000, $
TYPE=HEADING, FONT='Arial', STYLE=BOLD, SIZE=11, $
ENDSTYLE
END
```

The output is:

Order Revenue		
Order Number:	Date Of Order:	Order Total:
94710	2001/01/02	\$406,964.24
94680	2001/01/02	\$421,916.60
94670	2001/01/02	\$513,868.76
94550	2001/01/02	\$496,323.64
94530	2001/01/02	\$3,472.41
94520	2001/01/02	\$261,808.72
94490	2000/12/31	\$633,723.06
94460	2001/01/02	\$3,872.39
94430	2001/01/02	\$3,033.38
94410	2001/01/02	\$2,337.28

Applying Conditional Formatting Based on a Hidden (NOPRINT) Field's Values

This example illustrates how to apply conditional formatting based on the values of a hidden (NOPRINT) field. This report uses conditional formatting to draw attention to those employees who have resigned.

Notice that the WHEN attribute's condition evaluates a field (STATUS) that is hidden in the report. Although the field that is evaluated in the condition must be included in the report request, you can prevent it from displaying in the report by using the NOPRINT option, as shown in the following request.

```
TABLE FILE CENTHR
HEADING
"Employee List for Boston"
" "
"For Pay Levels 5+"
" "
"Resigned Employees Shown in <0>Red Bold"
" "
PRINT LNAME FNAME PAYSCALE STATUS NOPRINT
BY ID_NUM
WHERE PLANT EQ 'BOS' AND PAYSCALE GE 5
ON TABLE SET PAGE-NUM OFF
```

```

ON TABLE HOLD FORMAT HTML
ON TABLE SET STYLESHEET *
TYPE=REPORT, GRID=OFF, $
TYPE=DATA, COLUMN=LNAME,
    COLOR=RED, FONT='Arial', STYLE=BOLD, WHEN=STATUS EQ 'RESIGNED', $
TYPE=DATA, COLUMN=FNAME,
    COLOR=RED, FONT='Arial', STYLE=BOLD, WHEN=STATUS EQ 'RESIGNED',
$TYPE=HEADING, FONT='Arial', STYLE=BOLD, SIZE=11, $
TYPE=HEADING, LINE=5, STYLE=-BOLD, $
TYPE=HEADING, LINE=5, ITEM=2, STYLE=BOLD, COLOR=RED, $
ENDSTYLE
END

```

The output is:

Employee List for Boston			
For Pay Levels 5+			
Resigned Employees Shown in Red Bold			
Employee Last	First	Pay	
<u>ID#</u> <u>Name</u>	<u>Name</u>	<u>Level</u>	
39 GLIOZZO	ANTHONY	5	
46 HEBERT	BRYAN	5	
70 MIKITKA	MARK	5	
79 PALMER	TED	5	
85 PHILLIPS	CLAIRE	5	
91 ROUSSEAU	DIANE	5	
104 WHELEHAN	JAMES	5	
129 HAZARD	DAVID	6	
142 FLYNN	PAUL	6	

Applying Conditional Formatting to a Sort Group

This example illustrates how to apply conditional formatting to a sort group. This report uses conditional formatting to draw attention to those employees who have resigned.

Notice that one conditional declaration is able to apply formatting to all the rows in the sort group. You can accomplish this by evaluating the sort field (STATUS) in the WHEN attribute's condition.

```
TABLE FILE CENTHR
HEADING
"Employee List for Boston"
" "
"For Pay Levels 5+"
" "
PRINT LNAME FNAME PAYSCALE
BY STATUS SKIP-LINE
WHERE PLANT EQ 'BOS' AND PAYSCALE GE 5
ON TABLE SET PAGE-NUM OFF
ON TABLE HOLD FORMAT HTML
ON TABLE SET STYLESHEET *
TYPE=REPORT, GRID=OFF, $
TYPE=DATA,
  COLOR=RED, FONT='Arial', STYLE=BOLD, WHEN=STATUS EQ 'RESIGNED',$
TYPE=HEADING, FONT='Arial', STYLE=BOLD, SIZE=11, $
ENDSTYLE
END
```

The output is:

Employee List for Boston			
For Pay Levels 5+			
<u>Current Status</u>	<u>Last Name</u>	<u>First Name</u>	<u>Pay Level</u>
DECLINED	ROUSSEAU	DIANE	5
EMPLOYED	MIKITKA	MARK	5
	WHELEHAN	JAMES	5
	FLYNN	PAUL	6
RESIGNED	HEBERT	BRYAN	5
	PHILLIPS	CLAIRE	5
	HAZARD	DAVID	6
TERMINAT	GLIOZZO	ANTHONY	5
	PALMER	TED	5

In order to apply the same conditional formatting to only two columns, instead of all the columns, this version of the report request uses two declarations, each specifying a different column (LNAME and FNAME):

```
TABLE FILE CENTHR
HEADING
"Employee List for Boston"
" "
"Pay Levels 5+"
" "
PRINT LNAME FNAME PAYSACLE
BY STATUS SKIP-LINE
WHERE PLANT EQ 'BOS' AND PAYSACLE GE 5
ON TABLE SET PAGE-NUM OFF
ON TABLE HOLD FORMAT HTML
ON TABLE SET STYLESHEET *
TYPE=REPORT, GRID=OFF, $
TYPE=DATA, COLUMN=LNAME,
    COLOR=RED, FONT='Arial', STYLE=BOLD, WHEN=STATUS EQ 'RESIGNED', $
TYPE=DATA, COLUMN=FNAME,
```

```

COLOR=RED, FONT='Arial', STYLE=BOLD, WHEN=STATUS EQ 'RESIGNED', $
TYPE=HEADING, FONT='Arial', STYLE=BOLD, SIZE=11, $
ENDSTYLE
END

```

The output is:

Employee List for Boston			
For Pay Levels 5+			
<u>Current</u> <u>Status</u>	<u>Last</u> <u>Name</u>	<u>First</u> <u>Name</u>	<u>Pay</u> <u>Level</u>
DECLINED	ROUSSEAU	DIANE	5
EMPLOYED	MIKITKA	MARK	5
	WHELEHAN	JAMES	5
	FLYNN	PAUL	6
RESIGNED	HEBERT	BRYAN	5
	PHILLIPS	CLAIRE	5
	HAZARD	DAVID	6
TERMINAT	GLIOZZO	ANTHONY	5
	PALMER	TED	5

Using Sequential Conditional Formatting

This example illustrates how to apply sequential conditional formatting to a report. This report uses sequential conditional logic to format each row based on its order total (LINEPRICE).

```

TABLE FILE CENTORD
HEADING
"Order Revenue"
" "

```

```

SUM ORDER_DATE LINEPRICE AS 'Order,Total:'
BY HIGHEST 10 ORDER_NUM
ON TABLE SET PAGE-NUM OFF
ON TABLE HOLD FORMAT HTML
ON TABLE SET STYLESHEET *
TYPE=REPORT, GRID=OFF, $
1. TYPE=DATA, BACKCOLOR=AQUA, STYLE=BOLD+ITALIC,
   WHEN=LINEPRICE GT 600000, $
2. TYPE=DATA, BACKCOLOR=YELLOW, STYLE=BOLD,
   WHEN=LINEPRICE GT 400000, $
3. TYPE=DATA, BACKCOLOR=ORANGE, STYLE=ITALIC,
   WHEN=LINEPRICE GT 200000, $
4. TYPE=DATA, BACKCOLOR=SILVER, FONT='Arial', $
   TYPE=HEADING, FONT='Arial', STYLE=BOLD, SIZE=11, $
   ENDSTYLE
END

```

Notice that:

1. The first conditional declaration formats any rows whose order total is greater than \$600,000.
2. The second conditional declaration formats any rows whose order total is greater than \$400,000 and less than or equal to \$600,000, as rows with an order total greater than \$200,000 would have already been formatted by the first conditional declaration.
3. The third conditional declaration formats any rows whose order total is greater than \$200,000 and less than or equal to \$400,000, as rows with an order total greater than \$150,000 would have already been formatted by one of the first two conditional declarations.
4. The unconditional declaration following the conditional declarations specifies:
 - Background color, which is also specified by the conditional declarations. It applies background color (silver) to any rows whose order total is less than or equal to \$200,000, since those rows have not already been formatted by the conditional declarations.
 - Font, which is *not* specified by the conditional declarations. It applies font (Arial) to all data rows.

The output is:

Order Revenue		
Order Number:	Date Of Order:	Order Total:
94710	2001/01/02	\$406,964.24
94680	2001/01/02	\$421,916.60
94670	2001/01/02	\$513,868.76
94550	2001/01/02	\$496,323.64
94530	2001/01/02	\$3,472.41
94520	2001/01/02	\$261,808.72
94490	2000/12/31	\$633,723.06
94460	2001/01/02	\$3,872.39
94430	2001/01/02	\$3,033.38
94410	2001/01/02	\$2,337.28

Applying Conditional Formatting to Forecasted Values

The following illustrates how you can apply conditional formatting to forecasted values in a report.

```
DEFINE FILE GGSales
SDATE/YYM = DATE;
SYEAR/Y = SDATE;
SMONTH/M = SDATE;
PERIOD/I2 = SMONTH;
END
```

```
TABLE FILE GGSales
SUM UNITS DOLLARS
BY CATEGORY BY PERIOD
WHERE SYEAR EQ 97 AND CATEGORY EQ 'Coffee'
ON PERIOD RECAP MOVAVE/D10.1= FORECAST(DOLLARS,1,3,'MOVAVE',3);
ON TABLE SET PAGE-NUM OFF
ON TABLE HOLD FORMAT HTML
ON TABLE SET STYLE *
TYPE=REPORT, GRID=OFF, $
TYPE=REPORT, BACKCOLOR=SILVER, WHEN=FORECAST, $
```

```
ENDSTYLE
END
```

The output is:

Category	PERIOD	Unit Sales	Dollar Sales	MOVAVE
Coffee	1	61666	801123	801,123.0
	2	54870	682340	741,731.5
	3	61608	765078	749,513.7
	4	57050	691274	712,897.3
	5	59229	720444	725,598.7
	6	58466	742457	718,058.3
	7	60771	747253	736,718.0
	8	54633	655896	715,202.0
	9	57829	730327	711,158.7
	10	57012	724412	703,545.0
	11	51110	620264	691,667.7
	12	58981	762328	702,334.7
	13	0	0	694,975.6
	14	0	0	719,879.4
	15	0	0	705,729.9

Conditional Styling Based on ACROSS Values

FOCUS supports using ACROSS values to define conditional styling within the report. ACROSS values can now be used as part of the conditional expressions used to define styling attributes for each cell in the table.

Conditionally Styling an ACROSS Value

The example below demonstrates how the ACROSS value can be referenced using either the ACROSS field name or the ACROSS column designator (A1, A2).

In this example, the ACROSS values are used in conditional styling to set a unique bgcolor for all ACROSS columns in the Category Coffee, and additional font styling for the Espresso ACROSS column.

```

SET ACROSSTITLE=SIDE
TABLE FILE GGSALES
SUM DOLLARS/I8M AS ' '
BY REGION
BY ST
BY CITY
ACROSS CATEGORY
ACROSS PRODUCT
WHERE CATEGORY EQ 'Coffee' OR 'Food';
ON TABLE SET PAGE-NUM NOPAGE
ON TABLE NOTOTAL
ON TABLE HOLD FORMAT PDF
ON TABLE SET HTMLCSS ON
ON TABLE SET STYLE *
SQUEEZE=ON,UNITS=IN,ORIENTATION=PORTRAIT,$
TYPE=REPORT, FONT='ARIAL', SIZE=10, BORDER=LIGHT,$
TYPE=ACROSSTITLE, COLOR=WHITE, BACKCOLOR=GREY,$
TYPE=ACROSSVALUE, COLOR=WHITE, BACKCOLOR=GREY,$
TYPE=TITLE, COLOR=WHITE, BACKCOLOR=GREY,$
TYPE=DATA, ACROSSCOLUMN=DOLLARS, BACKCOLOR=THISTLE, WHEN=CATEGORY EQ
'Coffee', $
TYPE=DATA, ACROSSCOLUMN=DOLLARS, STYLE=BOLD+ITALIC, WHEN=A2 EQ
'Espresso', $
ENDSTYLE
END

```

The output is:

Category			Coffee			Food			
Region	State	City	Product	Capuccino	Espresso	Latte	Biscotti	Croissant	Score
Midwest	IL	Chicago			\$420,439	\$978,340	\$378,412	\$549,366	\$595,069
	MO	St. Louis			\$419,143	\$966,981	\$368,077	\$613,871	\$481,953
	TX	Houston			\$455,365	\$938,245	\$345,238	\$587,887	\$418,398
Northeast	CT	New Haven	\$158,995		\$279,373	\$926,052	\$589,355	\$551,489	\$283,874
	MA	Boston	\$174,344		\$248,356	\$917,737	\$570,391	\$497,234	\$332,486
	NY	New York	\$208,756		\$322,378	\$928,026	\$642,259	\$622,095	\$290,811
Southeast	FL	Orlando	\$317,027		\$256,539	\$889,887	\$511,597	\$602,076	\$311,836
	GA	Atlanta	\$352,161		\$317,389	\$907,365	\$555,231	\$661,806	\$273,420
	TN	Memphis	\$274,812		\$279,644	\$820,584	\$438,889	\$638,477	\$315,399
West	CA	Los Angeles	\$306,468		\$267,809	\$809,647	\$266,030	\$800,084	\$315,584
		San Francisco	\$279,830		\$338,270	\$935,862	\$269,518	\$824,457	\$292,839
	WA	Seattle	\$309,197		\$301,538	\$924,896	\$328,320	\$801,060	\$304,445

Using WHEN With ACROSSCOLUMN

If you use WHEN with ACROSSCOLUMN, styles are applied differently depending on whether the column referenced in the WHEN condition falls within ACROSS groups. A WHEN column that is within an ACROSS group controls the formatting of all data within the same ACROSS group.

In the following StyleSheet declaration, data values in the RETAIL_COST columns are formatted according to the data in their corresponding DEALER_COST columns:

```
TYPE=DATA,ACROSSCOLUMN=RETAIL_COST,COLOR=RED, WHEN=COUNTRY EQ
'ENGLAND', $
```

If a StyleSheet uses ACROSSCOLUMN with WHEN and a field name referenced in the WHEN condition appears both under the ACROSS and elsewhere in the report (as is possible with a multi-verb request), the field name under the ACROSS takes precedence. You can refer to the other column using another version of the column notation, such as Cn.

Field Interaction When Using ACROSSCOLUMN and WHEN

In this request, the RETAIL_COST column under each value of COUNTRY may be printed in italic with an aqua background color, depending on the corresponding value of DIFF:

```
TABLE FILE CAR
SUM RETAIL_COST AND DEALER_COST
COMPUTE DIFF/D12.2=RETAIL_COST - DEALER_COST;
ACROSS COUNTRY
WHERE COUNTRY EQ 'ENGLAND' OR 'FRANCE'
ON TABLE SET SQUEEZE ON
ON TABLE SET PAGE-NUM OFF
ON TABLE HOLD FORMAT HTML AS NF958068
ON TABLE SET STYLE *
TYPE=REPORT, FONT=TIMES, SIZE=10, $
TYPE=REPORT, GRID=OFF, $
TYPE=DATA, ACROSSCOLUMN=RETAIL_COST, BACKCOLOR=AQUA,
WHEN=DIFF GT 5000, STYLE=ITALIC, $
ENDSTYLE
END
```

The output is:

COUNTRY			FRANCE		
ENGLAND			RETAIL_COST	DEALER_COST	DIFF
45,319	37,853	7,466.00	5,610	4,631	979.00

To specify the DIFF field outside the ACROSS, use the notation C3:

```
WHEN=C3 GT 9000
```

Using ACROSSCOLUMN With WHEN

In this example, SEATS is an ACROSSCOLUMN under COUNTRY. Each value of SEATS is styled differently as a result of the WHEN conditions:

```
TABLE FILE CAR
PRINT SALES SEATS ACROSS COUNTRY
ON TABLE SET SQUEEZE ON
ON TABLE SET PAGE-NUM OFF
ON TABLE HOLD FORMAT HTML
ON TABLE SET STYLE *
TYPE=REPORT, ORIENTATION=LANDSCAPE, FONT=COURIER, $
TYPE=DATA, ACROSSCOLUMN=SEATS, WHEN=SEATS EQ 4, STYLE=BOLD,
  COLOR=BLUE, $
TYPE=DATA, ACROSSCOLUMN=SEATS, WHEN=SEATS GT 4, SIZE=12,
  COLOR=AQUA, $
TYPE=DATA, ACROSSCOLUMN=SEATS, WHEN=SEATS LT 4, STYLE=ITALIC,
  COLOR=RED, $
ENDSTYLE
END
```

The output is:

COUNTRY									
ENGLAND		FRANCE		ITALY		JAPAN		W GERMANY	
SALES	SEATS	SALES	SEATS	SALES	SEATS	SALES	SEATS	SALES	SEATS
0	4
12000	5
0	4
0	2
.	43000	4	.	.
.	35030	4	.	.
.	.	.	.	12400	2
.	.	.	.	13000	2
.	.	.	.	4800	4
.	.	.	.	0	2
.	7800	5
.	8950	5
.	8900	4
.	14000	5
.	18940	5
.	14000	5
.	15600	5
.	.	0	5

Using Conditional Grid Formatting in a Field

You can use conditional grid formatting in order to emphasize a particular cell or field in a PDF or PostScript report.

Creating a Report Using Conditional Grid Formatting

```
TABLE FILE CAR
SUM SALES BY CAR
ON TABLE HOLD FORMAT PDF
ON TABLE SET STYLE *
TYPE=REPORT, GRID=OFF,$
TYPE=DATA, COLUMN=SALES, GRID=HEAVY, WHEN=CAR EQ 'DATSUN', $
```

```
ENDSTYLE  
END
```

The output is:

<u>CAR</u>	<u>SALES</u>
ALFA ROMEO	30200
AUDI	7800
BMW	80390
DATSUN	43000
JAGUAR	12000
JENSEN	0
MASERATI	0
PEUGEOT	0
TOYOTA	35030
TRIUMPH	0

Cascading Style Sheets

Cascading style sheets (CSS) provide a standardized method for styling HTML documents. This W3C-authorized specification requires the use of a Web browser that fully supports CSS.

To use an existing cascading style sheet, simply link it to your report and, optionally, apply additional CSS classes to specific report components using the CLASS attribute. You can create or edit cascading style sheets with a text editor, or use a third-party Web page development tool.

What Are Cascading Style Sheets?

The World Wide Web Consortium's (W3C) cascading style sheets (CSS) specification defines a simple language for adding styling (such as fonts, colors, and spacing) to HTML documents. A style sheet separates the structural content of a document, defined in HTML, from the styling instructions, which are specified in a CSS. Each style sheet consists of one or more instructions or rules, called statements. Each statement includes a selector that tells a browser which elements on a page are affected by that statement, and a declaration that tells the browser how to draw or render them.

Benefits of Cascading Style Sheets

The benefits of using cascading style sheets to format reports include:

- **Increased formatting options.** Almost any formatting that you can specify in a cascading style sheet can be applied to a report, including options unavailable using native FOCUS StyleSheet attributes.
- **Reduced transmission bandwidth.** Cascading style sheets enable FOCUS to generate concise HTML output, reducing the bandwidth and overhead required to send output to the browser and display it.
- **Reduced effort.** Experienced designers have the option of applying CSS to their FOCUS reports as well, avoiding duplications in specifying and maintaining inline

formatting instructions.

- **Easier standards conformance.** Produce consistent documents for sites more easily by specifying default formatting for all Web documents of a similar type in a single cascading style sheet (as opposed to selectively replicating the formatting in inline FOCUS StyleSheets).

The Notion of Browser Dependence

In preparing to use CSS, it is important to understand the pivotal role played by the Web browser. It is the browser's support and implementation of CSS, and not FOCUS, that determines how (or if) a style sheet formats a styled report. Some browsers support CSS specifications fully, while others support only certain versions or formatting attributes, and some offer no support at all. Make sure that your browser and your readers' browsers all support CSS before proceeding.

Types of Cascading Style Sheets

When you create a HOLD file in HTML format, FOCUS generates most of the report output as an HTML table, placing each report item in a separate cell. Through the CSS feature, you can expedite the translation process and minimize the size of the generated HTML file by including an internal (or "embedded") CSS in your request.

You can employ several types of cascading style sheets with FOCUS:

- **Internal cascading style sheets** that are stored internally in the <head> element of the HTML documents that they format. When you include an internal CSS, FOCUS interprets your FOCUS StyleSheet instructions in a cascading style sheet that is stored in the metadata of your styled HTML output file. The viewing browser interprets this CSS to determine how to render the file contents.
- **External cascading style sheets** that you or someone else creates are stored in separate files accessible to the target browsers. Users may share documents linked to them. Specify an external CSS location in a FOCUS request using the CSSURL FOCUS StyleSheet attribute or the CSSURL SET parameter.

An external CSS is ideal for defining corporate-standard default styles (such as overall font/size), which users can then selectively override through FOCUS StyleSheet

attributes when adjusting styles for particular report components.

- **Inline Style Sheets** are stored within the tag of an HTML element or within the <head> of the document. These are generally not recommended, as they defeat the basic aim of using style sheets, which is the separation of content and style. They are supported, however, and can be used to override default style values in all other style sheets, as described in the next section.

Cascading Style Sheets and Precedence Rules

As the term "cascading" *implies*, you can apply several style sheets to a single document at the same time. For example, you may associate one style sheet with a document itself, link another style sheet to the first, and then associate a third with the Web browser on which the document is displayed. When multiple style sheets are in effect, they are applied to the document in a predetermined sequence set by the browser (not by FOCUS). The formatting cascades from one style sheet to the next. The precedence of style sheet methods, from highest priority to lowest, is as follows:

1. Inline Style.
2. Internal Style Sheet.
3. External Style Sheet.
4. Browser default.

Inline styles are physically defined within specific HTML elements, and cannot be overridden. An internal Style Sheet, whether coded by you or generated by FOCUS, consists of formatting declarations placed within the <head> tag of the generated HTML file. It is the way you typically override styling defaults established in an external cascading style sheet that resides on a corporate LAN server, and serves as a basic Web document template. External cascading style sheets offer an excellent mechanism for centralizing control of corporate publications throughout a site, but also save you the effort of repeating basic styling instructions from one report request to the next. Finally, you can set your Web browser to observe or ignore cascading style sheets, assuming it is capable of supporting them in the first place. You and the readers of any documents styled with CSS must have CSS-enabled browsers to view or work with them.

The actual process for using cascading style sheets in mainframe FOCUS involves several steps. First, in a FOCUS session specify (or link to) the style attributes that you wish to apply, and create a HOLD file in HTML format. The rest of this chapter discusses formatting methods and alternatives. After running your request, leave FOCUS and transfer the HOLD

file to your browser using FTP or another file transfer protocol. Then open the HTML file in your browser and view and work with the HTML file contents.

Cascading Style Sheet Formatting Statements: Rules and Classes

Cascading style sheets (CSS) define formatting in statements called *rules*. For example, this simple rule makes the background color of the body of an HTML page yellow:

```
BODY {background: yellow}
```

Each rule has a selector (BODY in this example) and a declaration (such as background: yellow). A declaration has a property (background) and a value assigned to the property (yellow). A declaration defines formatting, and a selector determines to what it applies. The selector can be any HTML element, or a class. You can define a class by creating a rule for it.

You define classes in a cascading style sheet, and then format report components by assigning CSS classes to them. Define different formatting for the same element by creating several classes for it. For example, if you wish to differentiate between text in sort columns, aggregate columns and detail columns, you can accomplish this by creating three separate classes of the BODY element, sortColumn, aggregateColumn, and detailColumn:

```
BODY.sortColumn {color: blue}  
BODY.aggregateColumn {color: green}  
BODY.detailColumn {color: black}
```

You can also define generic classes that are not limited to a single element. For example:

```
.pageFooting {font-weight: bolder}
```

You can use generic classes to specify formatting for any FOCUS report component.

Selecting a CSS Rule

When formatting a report, you have the choice of using BODY or TD rules for the entire report, or applying generic class rules to style individual components.

In choosing between the rules for BODY or TD, note that a rule for:

- **BODY** specifies default formatting for the entire Web page in which the report appears, including for the report itself. Note that this relies on CSS inheritance, which is Web browser-dependent.

If you wish to use cascading style sheets to format a report in the usual way, set STYLEMODE to FULL (the default) or PAGED. If you set it to FIXED and link to an external cascading style sheet, the report inherits formatting from the BODY and PRE elements, but you are unable to format the report using classes and the TD element.

- **TD** specifies default formatting only for the report, and for any other table cells on the page. (TD stands for table data, the table cell element. FOCUS generates most HTML report output as an HTML table, placing each report item in a separate cell. This enables a TD rule to format the entire report.)

When formatting a report component using a class rule, use a FOCUS StyleSheet to assign the class to the component using the CLASS attribute. When applying several CSS properties to the same report component, it is more efficient to declare them in a single class.

Naming CSS Classes

Class names are case-sensitive. It is recommended to name classes after the functions they perform, not the appearances of the components to which they are applied, so that the names remain This even if the report changes appearance. For example, if you want all report titles to be red, you may name the class declared to format titles Title, but preferably not Red.

Inheritance and CSS

Components in reports formatted using an external cascading style sheet inherit formatting from the TD element and from all elements within which the element nests, such as BODY.

(Inheritance, like all CSS behavior, is implemented by the user's Web browser and is browser-dependent.)

This differs from inheritance in a FOCUS StyleSheet, in which report components inherit formatting from higher-level components. When you format reports using external cascading style sheet classes, classes assigned to a report component do not inherit formatting from classes of higher-level components.

Inheriting Report Column Formatting From a TD Element

This report lists vendors that supply products to Gotham Grinds. Its formatting instructions specify that:

- The default background color for the entire report is orange. This is specified in a rule for the TD element.
- The data is displayed in an italic Arial font. The data inherits the orange background color from the rule for TD.
- The PRODUCT_ID data has a yellow background, overriding the default specified in the rule for TD. If the report formatting were specified in a FOCUS StyleSheet instead of in an external CSS, PRODUCT_ID would inherit the italic Arial font from its parent report component, the report data. Instead, because the formatting is specified in an external CSS, PRODUCT_ID inherits its formatting from the rule for the TD element.

The report request and inline FOCUS StyleSheet follow:

```
TABLE FILE GGPRODS
PRINT PRODUCT_DESCRIPTION VENDOR_NAME
BY PRODUCT_ID
ON TABLE SET PAGE-NUM OFF

ON TABLE HOLD AS CSSEXAM1 FORMAT HTML

ON TABLE SET STYLESHEET *
1. TYPE=REPORT, CSSURL = c:\Projects\report02.css, $
2. TYPE=DATA, CLASS=Data, $
3. TYPE=DATA, COLUMN=PRODUCT_ID, CLASS=Sort, $
   ENDSTYLE

END
```

The external cascading style sheet, report02.css, follows:

```

4. TD      {background:orange; border:0}
5. TABLE {border:0}
6. .Data  {font-style:italic; font-family:Arial}
7. .Sort  {background:yellow}

```

1. Set CSSURL to link to the external cascading style sheet report02.css. Alternatively, you can link to a URL on a Web server, as in the following example:

```
TYPE=REPORT, CSSURL=http://websrv1/CSS/reportstyles.css, $
```

2. Specify report data formatting using the CSS rule for the Data class.
3. Specify PRODUCT_ID data formatting using the CSS rule for the Sort class. This overrides the general declaration for formatting report data in line 2.
4. This CSS rule for the TD element specifies an orange background. Because this rule is for the TD, it is applied to the entire report. You can override TD formatting for a particular report component by applying a rule for a generic class to it, as is done in this procedure with the Sort class rule (see line 7).
5. CSS rules for the TD and TABLE elements remove the default grid from the report.
6. This CSS rule for the generic class Data specifies an Arial font family and an italic style. The FOCUS StyleSheet applies this to the report(tm)s data (see line 2). This rule inherits its background color from the rule for the TD element (line 4).
7. This CSS rule for the generic class Sort specifies a yellow background. The FOCUS StyleSheet applies this rule to PRODUCT_ID data (see line 3).
This rule overrides the default background color specified in line 4.

The output is:

Product Code	Product	Vendor Name
E141	Hazelnut	Coffee Connection
E142	French Roast	European Specialities,
E144	Kona	Evelina Imports, Ltd
F101	Secne	Ridgwood Bakeries
F102	Biscuiti	Delarivey Bakeries
F103	Croissant	West Side Bakers
G100	Mug	NY Ceramic Supply
G104	Thermos	ThermoTech, Inc
G110	Coffee Grinder	Appliance Craft
G121	Coffee Pot	Appliance Craft

Generating an Internal Cascading Style Sheet

When you select an HTML format for your report, you instruct FOCUS to generate HTML code to specify its formatting. You can optimize this process by generating an internal cascading style sheet as part of the output, in which case FOCUS places an internal cascading style sheet in the <head> of the HTML document. This, in turn:

- **Significantly reduces the size of the HTML file generated**, which, in turn, decreases the necessary transmission bandwidth and expedites the display of large reports.
- **Expands the options for formatting the HTML report.** Certain FOCUS StyleSheet attributes are only supported for HTML reports with internal cascading style sheets. These include the UNITS, BOTTOMMARGIN, TOPMARGIN, LEFTMARGIN, RIGHTMARGIN, SIZE, POSITION, WRAP, and PAGECOLOR attributes. Internal cascading style sheets also permit the addition or removal of underlines from most report components, and allow specification of exact starting positions and sizes of images.

Selecting a Unit of Measurement

You can choose inches, centimeters, or points as the unit of measurement for page margins and column widths in HTML reports that include an internal cascading style sheet.

To set the unit of measure, use one of the following:

- **StyleSheet:** UNITS attribute.
- **SET command:** UNITS parameter.

If you change the unit, existing measurements are automatically converted to the new scale. For example, if you set UNITS to inches and set the top margin to 1, and later change UNITS to centimeters, the top margin automatically converts to 1 centimeter.

Generate an Internal Cascading Style Sheet

To generate an internal cascading style sheet as part of the HTML report output, do the following:

- Outside a report request, use:

```
SET HTMLCSS = {ON|OFF}
```

- Within a report request, use:

```
ON TABLE SET HTMLCSS {ON|OFF}
```

where:

ON

Generates an internal cascading style sheet in the HTML output to control most aspects of the report's appearance.

OFF

Turns off the generation of an internal cascading style sheet. Instead, formatting tags are placed in each HTML table cell used to create the report. This is the default.

When generating an internal cascading style sheet, you can also apply an external one in the same request. Should the formatting instructions for a report component conflict, the internal cascading style sheet specifications override the corresponding specifications in the external cascading style sheet, thus providing a mechanism for runtime adjustment of external CSS settings.

Working With External Cascading Style Sheets

To format a report using an external cascading style sheet (CSS), you can:

- **Apply an existing CSS without changes.** Some sites use a single style sheet for all pages on their web site. The same style sheet could also be used for other types of documents.
- **Edit an existing CSS, adding or modifying rules.** For example, you can add generic classes to an existing style sheet to format your report's components. When you edit an existing CSS, the next time someone displays the report on a browser it reflects those changes without their having to rerun the report (provided an earlier version was not cached on the browser, in which case he or she has to refresh the view to see the edited version).
- **Create your own cascading style sheet to format reports.**

Applying CSS Styles

You can apply external cascading style sheet (CSS) formatting to:

- **A report component** (for example, to make a column italic). Assign cascading style sheet classes to report components using FOCUS StyleSheet CLASS attributes. When formatting tabular or free-form reports, you can format any report component by assigning CSS classes. To center headings or footings, use the CENTER option of the HEADING or FOOTING command, rather than doing this in a style sheet.
- **An entire report** (for example, to make an entire report italic). You can specify this formatting in an external CSS rule for the BODY or TD elements. You do not need a rule for a class of an element, nor do you need a FOCUS StyleSheet declaration when formatting an entire report with this approach.

When using an external cascading style sheet to format a report, it is recommended not to use a FOCUS StyleSheet to specify the report's formatting unless you also generate an internal cascading style sheet.

Use the CLASS Attribute to Apply CSS Formatting

To apply an external cascading style sheet (CSS) class to a report component, use the following syntax in a FOCUS StyleSheet declaration.

```
TYPE = type, [subtype,] CLASS = classname, [when,] [link,] $
```

where:

type

Identifies the report component to which you are applying the class's formatting. For tabular and free-form reports, it can be any component.

Each report component can be formatted by one class. If you specify several classes for a report component:

1. Classes in declarations with conditional formatting are evaluated first. For each cell in the report component, the first class whose condition is satisfied by the cell (tm)s row is assigned to the cell.
2. If there are no conditional declarations, or if no conditions are satisfied, the class in the first unconditional declaration is assigned to the report component. All subsequent declarations for that component are ignored.

subtype

Is an optional attribute and value needed to specify certain kinds of report components completely. For example, COLUMN and a column identifier are needed to specify a particular report column.

classname

Is the name of the cascading style sheet class you are applying to format the report component. You can assign the same class to multiple report components.

Class names are case-sensitive, and must agree with the case name in the class rule in the cascading style sheet. (Note, however, that not all Web browsers enforce case sensitivity for class names.)

when

Is an optional WHEN attribute and value. Supply this to apply conditional formatting.

link

Is an optional URL or JAVASCRIPT attribute and value. Supply this if you want to link the report component to another resource.

Using an External CSS - A Graphical Overview

Three items are required to style a report with an external cascading style sheet (CSS):

- **An external cascading style sheet** that specifies the formatting to be applied.
- **A FOCUS StyleSheet** in which you apply external CSS formatting attributes to your report components (this is not required if you format the entire report with the CSS).
- **A link to the external cascading style sheet** from the report.

This example demonstrates the interaction.

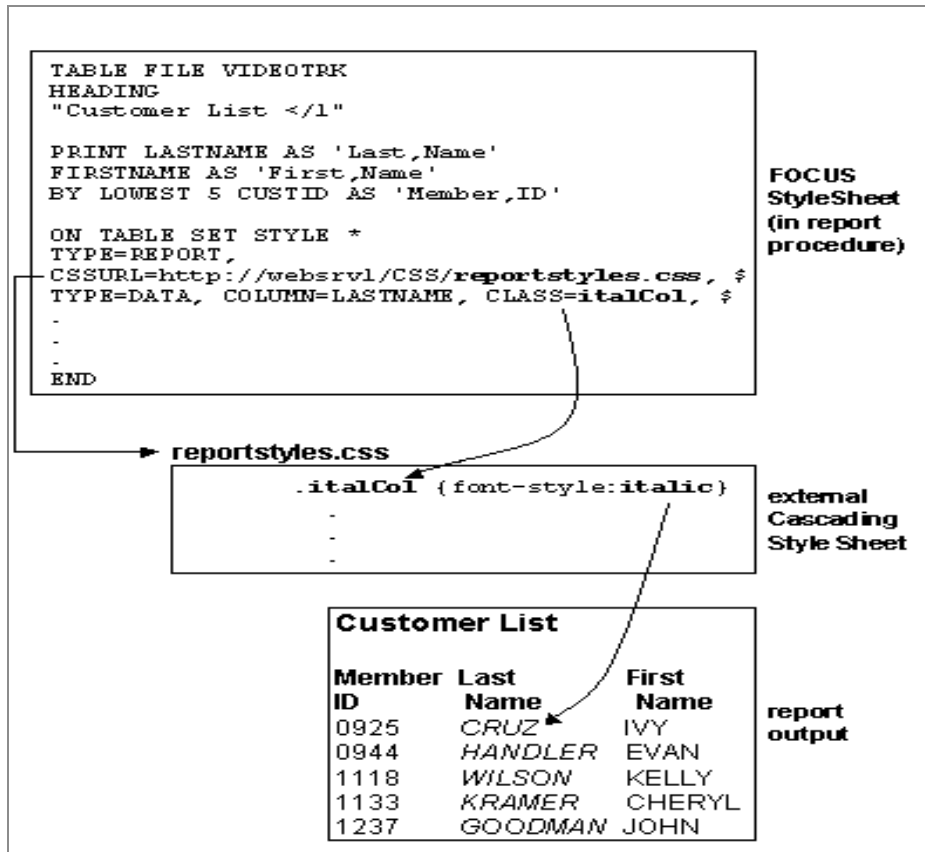

Format a Tabular Report With an External CSS

To format a report using an external cascading style sheet (CSS):

Procedure

1. **Specify the report formatting in the CSS.** To specify formatting for:
 - **A report component**, use a rule for any generic class (one not tied to an element). This cascading style sheet rule declares the ColumnTitle generic class:

```
.ColumnTitle {font-family:helvetica; font-weight:bold; color:blue;}
```
 - **The entire report**, use a rule for the BODY or TD elements (not for a class of

these elements), and skip Step 2. This is an effective way to specify default report formatting, and generates more efficient report output than applying a CSS class to the entire report. This cascading style sheet rule for the TD element specifies the element's font family:

```
TD {font-family:helvetica}
```

Because this rule is for the TD element, the formatting is applied to an entire report, not just a report component.

2. **Assign classes to report components.** In a FOCUS StyleSheet, use the CLASS attribute to assign a cascading style sheet class to each report component that you wish to format. You can assign each component a different class, and you can assign the same class to multiple components. This FOCUS StyleSheet example formats ACROSS values by applying the formatting for the ColumnTitle class:

```
TYPE=AcrossValue, CLASS=ColumnTitle, $
```

3. **Link to the CSS.** Link the external cascading style sheet by assigning either the URL or the fully qualified pathname for the CSS file, through either the CSSURL FOCUS StyleSheet attribute or the CSSURL SET parameter, as shown below:

- TYPE=REPORT, CSSURL = c:\projects\reportstyles.css
- TYPE=REPORT, CSSURL=http://webserv1/css/reportstyles.css

You can accomplish the same thing using a SET command:

- SET CSSURL = c:\projects\reportstyles.css
- SET CSSURL=http://webserv1/css/reportstyles.css

Formatting a Report Using a Cascading Style Sheet

This annotated report, which displays products currently offered by Gotham Grinds, is formatted using a cascading style sheet (report01.css). The formatting specifies that:

- The default font family is Arial.
The style sheet formatting overrides the report heading default font family of Times New Roman. The heading is also in a larger point size and is center-justified.
- All column titles are in a bold font and have a light-blue background.

- When a product's unit price is less than \$27, the report displays that product row in green italics.

The report request and inline FOCUS StyleSheet follow:

```
TABLE FILE GGPRODS
HEADING
"</1 Current Products</1"
PRINT PRODUCT_DESCRIPTION UNIT_PRICE
BY PRODUCT_ID
ON TABLE SET PAGE-NUM OFF

ON TABLE HOLD AS CSSEXAM2 FORMAT HTML

1. ON TABLE SET STYLE *
2. TYPE=REPORT, CSSURL=c:\Projects\report01.css, $
3. TYPE=HEADING, CLASS=headText, $
4. TYPE=TITLE, CLASS=reportTitles, $
5. TYPE=DATA, CLASS=lowCost, WHEN=N3 LT 27, $
6. ENDSTYLE
END
```

The external cascading style sheet, report01.css, follows:

```
7. BODY {font-family:Arial, sans-serif}
8. TABLE {border:0}
8. TD {border:0}
9. .reportTitles {font-weight:bolder; background:lightblue;}
10..lowCost {color:green; font-style:italic;}
11..headText {font-family:Times New Roman, serif; font-size:larger;
text-align:center}
```

1. Begin the inline FOCUS StyleSheet.
2. Link to the fully qualified pathname (or URL, if Web-based) of the external cascading style sheet report01.css.
3. Format the report(tm)s heading using the cascading style sheet(tm)s rule for the headText class.
4. Format the report(tm)s column titles using the CSS(tm)s rule for the reportTitles class.
5. For each report row for which the product(tm)s unit cost is less than \$27, format that

row using the CSS rule for the lowCost class.

6. End the inline FOCUS StyleSheet.
7. This CSS rule for the BODY element specifies the font family Arial, and if Arial is unavailable, the generic font family sans serif.

Because this is a rule for BODY, it is applied to the entire report: all text in the report defaults to Arial. You can override this for a particular report component by applying a rule for a generic class to that component, as is done in this procedure with the rule for the headText class (see line 11).

8. These CSS rules for the TABLE and TD elements remove the report(tm)s default grid.
9. This CSS rule for the generic class reportTitles specifies a bolder relative font weight and a light blue background color. The FOCUS StyleSheet applies this to the report (tm)s column titles (see line 4).
10. This CSS rule for the generic class lowCost specifies the text color green and the font style italic. The FOCUS StyleSheet applies this rule conditionally to report rows for which the product(tm)s unit cost is less than \$27 (see line 5).
11. The CSS rule for the generic class headText specifies the font family Times New Roman, and if Times New Roman is unavailable, the generic font family serif. It also specifies a larger relative font size and center justification.

The FOCUS StyleSheet applies this rule to the report(tm)s heading. It overrides the default font family specified in the rule for the BODY element (see line 7).

The output is:

Current Products		
Product Code	Product	Unit Price
B141	Hazelnut	58.00
B142	French Roast	81.00
B144	Kona	76.00
<i>F101</i>	<i>Scone</i>	<i>13.00</i>
<i>F102</i>	<i>Biscotti</i>	<i>17.00</i>
F103	Croissant	28.00
<i>G100</i>	<i>Mug</i>	<i>26.00</i>
G104	Thermos	96.00
G110	Coffee Grinder	125.00
G121	Coffee Pot	140.00

Combining CSS Styling With Other Formatting Methods

When using a cascading style sheet (CSS) to format a report, you can also apply other formatting methods, such as FOCUS StyleSheets and FOCUS TABLE Language.

Combining an External CSS With a FOCUS StyleSheet

When using an external cascading style sheet (CSS) to format a report, you can always use a FOCUS StyleSheet at the same time, whether or not you generate an internal cascading style sheet.

An effective approach is to link to an external CSS to provide basic report formatting, and then use a FOCUS StyleSheet to selectively override defaults for styling individual report components. Thus, a CSS BODY or TD rule can provide default report formatting, which you

can override by providing native FOCUS StyleSheet attributes for those individual report components.

Exceptions: Even when specifying external CSS classes, use native FOCUS StyleSheet attributes to:

- Create hyperlinks (using URL attributes). However, if you wish to format a hyperlink, do so using the cascading style sheet.
- Make a FOCUS StyleSheet declaration conditional (using the WHEN attribute).
- Embed an image (using the IMAGE attribute). If you wish to format the image to position it, do so using the cascading style sheet.

Performance considerations: Unless you also generate an internal cascading style sheet from the FOCUS StyleSheet, combining an external CSS and a FOCUS StyleSheet may reduce the performance benefits associated with the external CSS. This is because you generate more HTML code when styling a report with both external CSS and native FOCUS StyleSheet attributes than if you only use the external CSS. However, this still generates less code than if the report uses only native FOCUS StyleSheet attributes.

Do not double-format. Do not format the same property of the same report component using both an external CSS class (using the CLASS attribute) and a FOCUS StyleSheet attribute, since the class and the StyleSheet attribute could conflict.

For example, do not include the following declarations in the same StyleSheet:

```
TYPE=Data, COLUMN=Country, COLOR=Orange, $
TYPE=Data, CLASS=TextColor, $
```

because both try to assign a color to the report's Country column.

You can specify classes and FOCUS StyleSheet attributes that format different report components, and different properties of the same report component. For example, the following declarations are acceptable in the same StyleSheet:

```
1. TYPE=Heading, COLOR=Green, $
1. TYPE=Heading, CLASS=HeadingFontSize, $
2. TYPE=Data, Column=Country, BACKCOLOR=Yellow, $
2. TYPE=Data, Column=Car, CLASS=DataBackgroundColor, $
```

1. These two declarations are compatible because they format different properties (color and font size).

2. These two declarations are compatible because they format different report components (the Country column and the Car column).

Combining an External CSS With TABLE Language Formatting

TABLE language instructions. You can use TABLE language formatting instructions, such as HEADING CENTER, PAGE-BREAK, and spot markers, but never apply the same formatting to a report component using both a TABLE language instruction and an external cascading style sheet rule. For example, do not specify both of the following for the same report, because both attempt to align the page heading of the report:

- HEADING CENTER in the report request.
- Text-align in an external CSS, applied to the report's page heading.

Linking to an External Cascading Style Sheet

To format a report using an external cascading style sheet (CSS), you must link to the cascading style sheet by assigning a file location using the CSSURL attribute or parameter:

- Using CSSURL as a StyleSheet attribute enables you to specify all formatting information in one place, since you can specify a link to the external CSS, and references to CSS classes within the FOCUS StyleSheet. This makes it easier to maintain your formatting logic.
- Using CSSURL as a SET parameter enables you to switch a link quickly from one CSS to another, which is useful for redirecting many reports at once. To do so, put the SET CSSURL command in its own procedure, and merge it into other report procedures by inserting a -INCLUDE Dialogue Manager command in each.

When the CSSURL is specified in several ways, the most local specification takes precedence. The order of precedence, from local (1) to global (3), is:

```
1. TYPE=REPORT, CSSURL = url_or_fully-qualified pathname
```

```
2. ON TABLE SET CSSURL url_or_fully-qualified pathname
```

```
3. SET CSSURL = url_or_fully-qualified pathname
```

Use the CSSURL SET Parameter to Link to an External CSS

To link an external cascading style sheet (CSS) to a report using a SET parameter, issue the following command in a procedure:

```
SET CSSURL = css_url_or_fully-qualified pathname
```

or the following ON TABLE SET command in a report request:

```
ON TABLE SET CSSURL css_url_or_fully-qualified pathname
```

where:

css_url_or_fully-qualified pathname

Is the location of the external cascading style sheet (assume it is case-sensitive).

The length limit is:

- 69 characters in a SET command.
- 57 characters in an ON TABLE SET command.

Linking to an External cascading style sheet Using the CSSURL Attribute

This report displaying products offered by Gotham Grinds is formatted using an external cascading style sheet (CSS) that is linked through the CSSURL attribute in the FOCUS StyleSheet:

```

TABLE FILE GGPRODS
HEADING
"</1 Current Products</1"
PRINT PRODUCT_DESCRIPTION UNIT_PRICE
BY PRODUCT_ID
ON TABLE SET PAGE-NUM OFF
ON TABLE HOLD AS CSSEXAM3 FORMAT HTML

ON TABLE SET STYLESHEET *
TYPE=REPORT, CSSURL = c:\projects\report01.css, $
TYPE=HEADING, CLASS=headText, $
TYPE=TITLE, CLASS=reportTitles, $
TYPE=DATA, CLASS=lowCost, WHEN=N3 LT 27, $
ENDSTYLE
END

```

The output is:

Current Products		
Product Code	Product	Unit Price
B141	Hazelnut	58.00
B142	French Roast	81.00
B144	Kona	76.00
<i>F101</i>	<i>Scone</i>	<i>13.00</i>
<i>F102</i>	<i>Biscotti</i>	<i>17.00</i>
F103	Croissant	28.00
<i>G100</i>	<i>Mug</i>	<i>26.00</i>
G104	Thermos	96.00
G110	Coffee Grinder	125.00
G121	Coffee Pot	140.00

Use the CSSURL Attribute to Link to an External CSS

Use the following syntax to link an external cascading style sheet (CSS) to your report using a FOCUS StyleSheet attribute:

```
[TYPE=REPORT,] CSSURL=css_path, $
```

where:

TYPE=REPORT

Specifies that this attribute is being applied to the entire report. If it is omitted, the StyleSheet declaration still defaults to this setting.

css_path

Specifies the URL or fully-qualified path name of the location where the external cascading style sheet definition file resides.

If you specify CSSURL multiple times, the last value specified in an ON TABLE SET command overrides all the other values within that report request. If CSSURL is not specified within a report request, the last value specified with SET overrides all the others.

FAQ About Using External Cascading Style Sheets

This topic answers the most frequently asked questions (FAQ) about using external cascading style sheets (CSS) to format reports.

Does it answer your question? Please send in any questions that you may still have. Each question will get a response, and will also be considered for inclusion in a future release of the FAQ. Any comments on this document are also welcome.

You can:

- **E-mail them** to books_info@ibi.com. Please include your name and phone number, and put *Cascading Style Sheet FAQ* in the subject line.

- **Send them to:**

Documentation Services

Attn: Core Reporting Group

Information Builders

Two Penn Plaza

New York, NY 10121-2898

Please include your name, phone number, e-mail address, and postal address.

How do I specify a report's default formatting using CSS?

Specify default formatting for an entire report in an external cascading style sheet rule for the BODY or TD element.

Do I always need to use the CLASS attribute?

No. You need a CLASS attribute in a FOCUS StyleSheet if you specify formatting for an individual report component. You use CLASS to assign a rule for a generic class to the report component. When you specify formatting for the entire report, you do so in a rule for the BODY or TD element, not in a rule for a class, so you omit the CLASS attribute.

Can I use a cascading style sheet and a FOCUS StyleSheet together?

When linking to an external cascading style sheet, you can also specify native FOCUS StyleSheet attributes in a FOCUS StyleSheet. However, if you do not generate an internal cascading style sheet, you should not specify CSS classes (CLASS=) and native FOCUS StyleSheet attributes in the same FOCUS StyleSheet (except to specify conditional formatting, to specify a link to another resource, or to embed an image).

Which version of CSS does FOCUS support?

Support for different versions of cascading style sheets (such as CSS2) is determined entirely by your Web browser's support and implementation of cascading style sheets, not by FOCUS.

Which types of reports can I format using an external cascading style sheet?

You can format tabular reports, including regular (column-oriented) reports and Financial Modeling Language (FML, also known as extended matrix or row-oriented) reports.

Troubleshooting Cascading Style Sheets

This topic addresses some common problems encountered when formatting reports with cascading style sheets (CSS).

What problems did you encounter? If you have troubleshooting suggestions that you think others will find helpful, you may send them to be considered for inclusion in a future release. You can:

- **E-mail them** to books_info@ibi.com. Please include your name and phone number, and put **Cascading Style Sheet troubleshooting for FOCUS applications** in the subject line.

- **Send them to:**

Documentation Services

Attn: Core Reporting Group

Information Builders

Two Penn Plaza

New York, NY 10121-2898

Please include your name, phone number, e-mail address, and postal address.

Symptom: The report is not using any of the cascading style sheet's formatting.

- **Reason 1:** Your Web browser may not support cascading style sheets.

Solution 1: Check to be sure that your browser supports cascading style sheets; if it does not, install an appropriate browser version.

- **Reason 2:** Your Web browser may be set to ignore cascading style sheets.

Solution 2: Reset the browser to accept a document's cascading style sheet. For instructions about checking or changing a browser's setting, see your browser's help.

Symptom: The report reflects some, but not all, of the CSS formatting.

- **Reason 1:** The support and implementation of cascading style sheets in your web browser determines how a cascading style sheet rule formats your report. It has

nothing to do with FOCUS. You may experience this symptom because your browser does not support the level of cascading style sheets that you are using, leaving some CSS features unimplemented.

Solution 1: Upgrade your browser to a version that supports all the CSS features used to format the report, or edit the cascading style sheet to remove features that are unsupported by some of the browsers that are used to display the report.

- **Reason 2:** Your web browser may be set to use your personal cascading style sheet, and you may have rules there that override those specified in the cascading style sheet assigned to the report. See your third-party CSS documentation.

Solution 2: Reset your browser to accept the cascading style sheet for each document, or edit the rules in the two cascading style sheets so that they no longer conflict.

- **Reason 3:** Certain web browsers ignore an entire rule if they do not support a property specified in it. If your web browser does not support a property specified in a rule for one of the classes assigned to the report, none of the report components to which that rule was assigned are formatted.

Solution 3: Remove the unsupported property, or upgrade your browser to a version that supports the property.

- **Reason 4:** Each report component can be assigned only one cascading style sheet class. If you have specified more than one class, only the first one specified is assigned to the component; the others are ignored.

If a class has not yet been assigned to a report cell, and you specify conditional formatting for it, only the first class whose condition is satisfied by that row is assigned to the cell. The others are ignored.

Solution 4: Do not assign more than one CSS class to each report component. If you need to apply multiple attributes, bundle them into a single class.

- **Reason 5:** Some web browsers implement CSS inheritance rules for nested elements in ways that do not conform to the CSS standard. If you are using such a browser, for example, you specify some formatting in a rule for the BODY element, your browser may not apply the rule to other elements nested within BODY.

Solution 5: Specify the formatting of a report in a rule for a different element (for example, if the browser does not correctly implement inheritance from BODY, use a rule for TD), or else upgrade your browser to a version that correctly supports inheritance.

- **Reason 6:** External cascading style sheets can be subject to certain restrictions when

used with other formatting methods. For example, if the FOCUS StyleSheet for a report does not generate an internal cascading style sheet, but it references external CSS classes and also specifies native FOCUS StyleSheet attributes, there may be a formatting conflict.

Solution 6: The solution depends on the kind of formatting conflict. In the example above, the solution is to generate an internal cascading style sheet.

Advanced StyleSheet Features

Some advanced StyleSheet features include positioning, arranging, and aligning elements, adding images, grids and borders, and linking in a report. These features are described in this chapter.

For information about creating a StyleSheet, identifying and styling report components, and choosing a styled output format, see [Styling Reports](#).

Positioning a Report Component

A StyleSheet enables you to specify an absolute or relative starting position for a column, heading, or footing, or element in a heading or footing. You can also add blank space around a report component.

For a PDF, PS, or HTML report, you can use the POSITION attribute in a StyleSheet to specify a starting position for a heading or footing, expressed as a unit measurement. For HTML, this capability requires an internal cascading style sheet. For details on selecting an alignment method, see [Aligning Heading and Footing Elements](#).

In addition, for a PDF or PS report, you can use the POSITION attribute to specify an absolute or relative starting position for an element within a heading or footing, or to align an item in a heading or footing with a report column. An absolute starting position is the distance from the left margin of the report. A relative starting position is the distance from the preceding object. For the first item on a heading line this is the left margin of the report.

In an HTML report, you can use related syntax and an internal Cascading StyleSheet to position an image in a heading or footing.

Positioning Attributes

Attribute	Description	Applies to
POSITION	<p>Sets the absolute or relative starting position of a column.</p> <p>An absolute position is the distance from the left margin of the printed paper.</p> <p>A relative position is the distance from the default position. After the first column, the default position is the end of the preceding column.</p>	PDF PS
TOPGAP BOTTOMGAP	<p>Adds blank space to the top or bottom of a report line.</p>	PDF PS
LEFTGAP RIGHTGAP	<p>Adds blank space to the left or right of a report column.</p>	PDF PS

Specify the Starting Position of a Column

This syntax applies to a PDF or PS report.

```
TYPE=REPORT, COLUMN=identifier, POSITION={+|-}position, $
```

where:

identifier

Selects a single column and collectively positions the column title, data, and totals if applicable. For valid values, see [Identifying an Entire Report, Column, or Row](#).

+

Starts the column at the specified distance to the right of the default starting position.

By default, text items and alphanumeric fields are left-justified in a column, and numeric fields are right-justified in a column.

-

Starts the column at the specified distance to the left of the default starting position.

It is possible to create a report in which columns overlap. If this occurs, simply adjust the values.

position

Is the desired distance, in the unit of measurement specified with the UNITS attribute.

Set a Starting Position for a Heading or Footing

Use the following syntax to specify a starting position for an entire heading or footing in relation to the left margin of a report.

```
TYPE = headfoot, POSITION = position, $
```

where:

headfoot

Is the type of heading or footing. Valid values are TABHEADING, TABFOOTING, HEADING, FOOTING, SUBHEAD, and SUBFOOT.

position

Is the desired distance from the left, expressed by the UNITS attribute (the default is INCHES).

i **Note:** In an HTML report, this syntax must be used in conjunction with an internal cascading style sheet.

Set a Starting Position for a Heading or Footing Element

For a PDF or PS report, use the following syntax to specify a starting position for a heading or footing element in relation to the preceding item.

```
TYPE = headfoot, [subtype,] POSITION = {+|-}option, $
```

where:

headfoot

Is the type of heading or footing. Valid values are TABHEADING, TABFOOTING, HEADING, FOOTING, SUBHEAD, and SUBFOOT.

subtype

Are additional attributes that identify the report component. These options can be used separately or in combination, depending upon the degree of specificity you need to fully identify an element. Valid values are:

LINE which identifies a line by its position in a heading or footing. Identifying individual lines enables you to format each line differently.

If a heading or footing has multiple lines and you apply a StyleSheet declaration that does not specify LINE, the declaration is applied to *all* lines. Blank lines are counted when interpreting the value of LINE.

ITEM which identifies an item by its position in a line. To divide a heading or footing line into items, you can use the <+0> spot marker.

To determine an ITEM number for an OBJECT, follow these guidelines:

- When used with OBJECT=TEXT, count only the text strings from left to right.
- When used with OBJECT=FIELD, count only values from left to right.
- When used without OBJECT, count text strings and field values from left to right.

If you apply a StyleSheet declaration that specifies ITEM, the number is counted from the beginning of each line in the heading or footing, not just from the beginning of the first line.

OBJECT which identifies an element in a heading or footing as a text string or field value. Valid values are TEXT or FIELD. TEXT may represent free text or a Dialogue Manager ampersand (&) variable.

It is not necessary to specify OBJECT=TEXT unless you are styling both text strings and embedded fields in the same heading or footing.

option

Is the alignment method. Valid values are:

position which is the desired distance, expressed by the UNITS attribute (the default is inches) for absolute positioning.

+ which starts the heading or footing element at the specified distance to the *right* of the preceding item. For the first item in a heading or footing, the preceding item is the left margin of the report.

- which starts the heading or footing element at the specified distance to the *left* of the preceding item. This is useful if you want to overlap images in a heading.

column_title which aligns the heading or footing element with the first character of the designated column.

Specifying an Absolute Starting Position for a Column

The following illustrates how to position a column in a printed report. The request specifies that the PRODUCT_DESCRIPTION field should appear three inches from the left margin of

the PDF report.

```
TABLE FILE GGORDER
"PRODUCTS ORDERED ON 08/01/96"
SUM QUANTITY BY PRODUCT_DESCRIPTION
WHERE ORDER_DATE EQ '080196'
ON TABLE SET PAGE-NUM OFF
ON TABLE HOLD FORMAT PDF
ON TABLE SET STYLE *
TYPE=REPORT, COLUMN=PRODUCT_DESCRIPTION, POSITION=3, $
ENDSTYLE
END
```

The output is:

PRODUCTS ORDERED ON 08/01/96	
<u>Product</u>	<u>Ordered Units</u>
Biscotti	6140
Coffee Grinder	2493
Coffee Pot	3100
Croissant	7465
French Roast	12965
Hazelnut	4186
Kona	2591
Mug	5332
Scone	5949
Thermos	2362

Specifying a Relative Starting Position for a Column

This request positions the column title and data for the QUANTITY field two inches from the default position; in this case, two inches from the end of the preceding column.

```
TABLE FILE GGORDER
"PRODUCTS ORDERED ON 08/01/96"
SUM QUANTITY BY PRODUCT_DESCRIPTION
WHERE ORDER_DATE EQ '080196'
ON TABLE SET PAGE-NUM OFF
ON TABLE HOLD FORMAT PDF
ON TABLE SET STYLE *
TYPE=REPORT, COLUMN=PRODUCT_DESCRIPTION, POSITION=3, $
TYPE=REPORT, COLUMN=QUANTITY, POSITION=+2, $
```

```
ENDSTYLE
END
```

QUANTITY, titled Ordered Units in the report, is relatively positioned to Product:

PRODUCTS ORDERED ON 08/01/96	
<u>Product</u>	<u>Ordered Units</u>
Biscotti	6140
Coffee Grinder	2493
Coffee Pot	3100
Croissant	7465
French Roast	12965
Hazelnut	4186
Kona	2591
Mug	5332
Scone	5949
Thermos	2362

Setting an Absolute Starting Position for a Heading Item

This request uses the spot marker <+0> to divide the report heading into three text strings. It starts the third text string, 1st Qtr 2001, 3 inches from the left report margin. This technique can be used in PDF as well as PS reports.

```
TABLE FILE GGSales
SUM UNITS DOLLARS BY CATEGORY BY PRODUCT
ON TABLE SUBHEAD
"Sales Report - <+0>All Products<+0> 1st Qtr 2001"
" "
ON TABLE SET PAGE-NUM OFF
ON TABLE SET SQUEEZE ON
ON TABLE HOLD FORMAT PDF
ON TABLE SET STYLESHEET *
TYPE = TABHEADING, OBJECT = TEXT, ITEM=1, SIZE = 12, STYLE = BOLD, $
TYPE = TABHEADING, OBJECT = TEXT, ITEM=2, STYLE = BOLD, $
TYPE = TABHEADING, OBJECT = TEXT, ITEM=3, POSITION = 3, $
ENDSTYLE
END
```

The output is:

Sales Report - All Products		1st Qtr 2001	
<u>Category</u>	<u>Product</u>	<u>Unit Sales</u>	<u>Dollar Sales</u>
Coffee	Capuccino	189217	2381590
	Espresso	308986	3906243
	Latte	878063	10943622
Food	Biscotti	421377	5263317
	Croissant	630054	7749902
	Scone	333414	4216114
Gifts	Coffee Grinder	186534	2337567
	Coffee Pot	190695	2449585
	Mug	360570	4522521
	Thermos	190081	2385829

Setting a Relative Starting Position for a Heading Item

This request uses the spot marker <+0> to divide the report heading into three text strings. It starts the third text string, 1st Qtr 2001, one inch to the right of the previous item on the heading line. Inches are the default unit of measure. This technique can be used in PDF as well as PS reports.

```
TABLE FILE GGSales
SUM UNITS DOLLARS BY CATEGORY BY PRODUCT
ON TABLE SUBHEAD
"Sales Report - <+0>All Products<+0> 1st Qtr 2001"
" "
ON TABLE SET PAGE-NUM OFF
ON TABLE SET SQUEEZE ON
ON TABLE HOLD FORMAT PDF
ON TABLE SET STYLESHEET *
TYPE = TABHEADING, OBJECT = TEXT, ITEM=1, SIZE = 12, STYLE = BOLD, $
TYPE = TABHEADING, OBJECT = TEXT, ITEM=2, STYLE = BOLD, $
TYPE = TABHEADING, OBJECT = TEXT, ITEM=3, POSITION = +1, $
ENDSTYLE
END
```

The output is:

Sales Report - All Products		1st Qtr 2001	
<u>Category</u>	<u>Product</u>	<u>Unit Sales</u>	<u>Dollar Sales</u>
Coffee	Capuccino	189217	2381600
	Espresso	308986	3906243
	Latte	878063	10943622
Food	Biscotti	421377	5263328
	Croissant	630054	7749902
	Scone	333414	4216114
Gifts	Coffee Grinder	186534	2337567
	Coffee Pot	190695	2449585
	Mug	360570	4522521
	Thermos	190081	2385829

Aligning a Heading Item With a Column

This request uses the spot marker <+0> to divide the report heading into three text strings. It starts the second text string at the horizontal position where the column UNITS (Unit Sales) is. This technique can be used in PDF as well as PS reports.

```
TABLE FILE GGSales
SUM UNITS DOLLARS BY CATEGORY BY PRODUCT
ON TABLE SUBHEAD
"Sales Report - <+0>All Products<+0> 1st Qtr 2001"
" "
ON TABLE SET PAGE-NUM OFF
ON TABLE HOLD FORMAT PDF
ON TABLE SET SQUEEZE ON
ON TABLE SET STYLESHEET *
TYPE = TABHEADING, LINE=1, ITEM=2, POSITION=UNITS, $
ENDSTYLE
END
```

The output is:

Sales Report -		All Products 1st Qtr 2001	
Category	Product	Unit Sales	Dollar Sales
Coffee	Capuccino	189217	2381590
	Espresso	308986	3906243
	Latte	878063	10943622
Food	Biscotti	421377	5263317
	Croissant	630054	7749902
	Scone	333414	4216114
Gifts	Coffee Grinder	186534	2337567
	Coffee Pot	190695	2449585
	Mug	360570	4522521
	Thermos	190081	2385829

You can employ several types of spot markers to refine the positioning of headings and footings, and elements within them, in HTML and PDF reports that use proportional fonts. For maximum control, you can combine spot markers with other alignment techniques.

You can also use spot markers to position heading and footing elements at fixed and relative column locations. Several spot markers control positioning based on the pre-defined width of a character in a monospace font. This formatting technique is not supported for proportional fonts.

Add Blank Space Around a Report Component

In a PDF or PostScript report, you can add space around report components.

Use the TOPGAP and BOTTOMGAP attributes to control spacing between heading or footing lines, and between heading or footing text and the grid lines above and below them.

i Note: You can use TOPGAP and BOTTOMGAP with multi-line headings. Keep in mind that between heading lines, the top *and* bottom gap will be inserted, making the spacing between lines greater than the spacing at the top and bottom of the heading.

```
TYPE=headfoot, {TOPGAP|BOTTOMGAP}=gap, $
TYPE=REPORT, {TOPGAP|BOTTOMGAP}=gap, $
  TYPE=type, [COLUMN=identifier,|ACROSSCOLUMN=acrosscolumn,]
  {LEFTGAP|RIGHTGAP}=gap, $
```

where:

TOPGAP

Indicates how much space to add above the report line.

BOTTOMGAP

Indicates how much space to add below the report line.

gap

Is the amount of blank space, in the unit of measurement specified with the UNITS attribute.

In the absence of grids or background color, the default value is 0. For RIGHTGAP, the default value is proportional to the size of the text font.

In the presence of grids or background color, the default value increases to provide space between the grid and the text or to extend the color beyond the text.

The gaps must be the same within a single column or row. That is, you cannot specify different left or right gaps for individual cells in the same column, or different top and bottom gaps for individual cells in the same row.

type

Identifies the report component. For valid values, see [Identifying Report Components](#).

identifier

Selects one or more columns using the COLUMN attribute described in [Identifying an Entire Report, Column, or Row](#).

acrosscolumn

Selects the same column under each occurrence of an ACROSS sort field, using the ACROSSCOLUMN attribute described in [Identifying an Entire Report, Column, or Row](#).

LEFTGAP

Indicates how much space to add to the left of a report column.

RIGHTGAP

Indicates how much space to add to the right of a report column.

i Note: For TOPGAP, BOTTOMGAP, LEFTGAP, and RIGHT GAP, you must specify a value of at least 0.013889 (the decimal size of a point in inches). If you specify a value less than this, FOCUS will round down to the nearest point, which is zero.

Adding Blank Space Above Data Values

This request generates one-tenth of an inch of blank space above every data value in a PDF report.

```
SET PAGE-NUM = OFF
TABLE FILE GGORDER
"PRODUCTS ORDERED ON 08/01/96"
" "
SUM QUANTITY BY PRODUCT_DESCRIPTION
WHERE ORDER_DATE EQ '080196'
ON TABLE HOLD FORMAT PDF
ON TABLE SET STYLE *
TYPE=DATA, TOPGAP = 0.1, $
ENDSTYLE
END
```

The data is spaced for readability:

PRODUCTS ORDERED ON 08/01/96	
<u>Product</u>	<u>Ordered Units</u>
Biscotti	6140
Coffee Grinder	2493
Coffee Pot	3100
Croissant	7465
French Roast	12965
Hazelnut	4186
Kona	2591
Mug	5332
Scone	5949
Thermos	2362

Adding Blank Space to Separate Heading Text From Grid Lines in a PDF Report

This request generates a PDF report with blank space added above and below the report heading to separate the text from the upper and lower grid lines. The space above is added by the TOPGAP attribute; the space below is added by the BOTTOMGAP attribute.

```
TABLE FILE GGSALES
SUM BUDUNITS UNITS BUDDOLLARS DOLLARS
BY CATEGORY
ON TABLE SUBHEAD
"SALES REPORT <+0>December 2001"
ON TABLE SET PAGE-NUM OFF
ON TABLE HOLD FORMAT PDF
ON TABLE SET SQUEEZE ON
ON TABLE SET STYLE SHEET *
TYPE = TABHEADING, GRID=ON, JUSTIFY=CENTER, TOPGAP=.25, BOTTOMGAP=.25, $
TYPE = TABHEADING, FONT='TIMES', SIZE=12, STYLE=BOLD, $
TYPE = TABHEADING, ITEM=2, SIZE=10, STYLE=ITALIC, $
ENDSTYLE
END
```

The output is:

SALES REPORT <i>December 2001</i>				
<u>Category</u>	<u>Budget Units</u>	<u>Unit Sales</u>	<u>Budget Dollars</u>	<u>Dollar Sales</u>
Coffee	1385923	1376266	17293886	17231455
Food	1377564	1384845	17267160	17229333
Gifts	931007	927880	11659732	11695502

Controlling Column Title Underlining Using a StyleSheet Attribute

The TITLELINE attribute allows you to control whether column titles are underlined for report output.

You can also control column title underlining using the SET TITLELINE command. For more information, see [Customizing Tabular Reports](#).

Control Column Title Underlining Using a StyleSheet Attribute

```
TYPE={REPORT|TITLE}, TITLELINE = (ON|OFF|SKIP)
```

where:

ON

Underlines column titles. ON is the default value.

OFF

Replaces the underline with a blank line.

SKIP

Omits both the underline and the line on which the underline would have displayed.

Controlling Column Title Underlining Using a StyleSheet Attribute

The following request has a BY and an ACROSS field.

```
TABLE FILE GGSALES
SUM UNITS BY PRODUCT
ACROSS REGION
ON TABLE SET PAGE-NUM OFF
ON TABLE HOLD FORMAT HTML
ON TABLE SET STYLE *
TYPE=REPORT, TITLELINE=ON, GRID=OFF, FONT=ARIAL,$
ENDSTYLE
END
```

With the default value (ON) for TITLELINE, the column titles are underlined.

Product	Region			
	Midwest	Northeast	Southeast	West
Biscotti	86105	145242	119594	70436
Capuccino	.	44785	73264	71168
Coffee Grinder	50393	40977	47083	48081
Coffee Pot	47156	46185	49922	47432
Croissant	139182	137394	156456	197022
Espresso	101154	68127	68030	71675
Latte	231623	222866	209654	213920
Mug	86718	91497	88474	93881
Scone	116127	70732	73779	72776
Thermos	46587	48870	48976	45648

With TITLELINE=OFF, the column titles are not underlined, but the blank line where the underlines would have been is still there.

Product	Region			
	Midwest	Northeast	Southeast	West
Biscotti	86105	145242	119594	70436
Capuccino	.	44785	73264	71168
Coffee Grinder	50393	40977	47083	48081
Coffee Pot	47156	46185	49922	47432
Croissant	139182	137394	156456	197022
Espresso	101154	68127	68030	71675
Latte	231623	222866	209654	213920
Mug	86718	91497	88474	93881
Scone	116127	70732	73779	72776
Thermos	46587	48870	48976	45648

With TITLELINE=SKIP, both the underlines and the blank line are removed.

Product	Region			
	Midwest	Northeast	Southeast	West
Biscotti	86105	145242	119594	70436
Capuccino		44785	73264	71168
Coffee Grinder	50393	40977	47083	48081
Coffee Pot	47156	46185	49922	47432
Croissant	139182	137394	156456	197022
Espresso	101154	68127	68030	71675
Latte	231623	222866	209654	213920
Mug	86718	91497	88474	93881
Scone	116127	70732	73779	72776
Thermos	46587	48870	48976	45648

Arranging Pages and Columns on a Page

How easily a user locates data depends on the arrangement of columns on a page. You have many design options. Using StyleSheet attributes or commands, you can:

- Determine column width.
- Control the number of spaces between columns.
- Change the order of vertical sort (BY) columns.
- Stack columns to reduce report width, or to easily compare values in a report by creating a matrix.
- Specify the absolute or relative starting position for a column.

Column Arrangement Features

Feature	Description	Applies to
SQUEEZE	Sets column width.	HTML (requires FONT=DEFAULT-FIXED) PDF PS
SET SPACES	Sets number of spaces between columns.	HTML (requires SET STYLEMODE=FIXED)
SEQUENCE	Sets column order.	PDF PS
FOLD-LINE	Reduces report width by stacking columns.	PDF PS
OVER	Stacks columns by placing them over one another.	HTML PDF PS
IN {n +n}	Sets the absolute or relative starting position of a column.	HTML (requires SET STYLEMODE=FIXED) PDF PS

For more information, see [Customizing Tabular Reports](#).

Determining Column Width

The value of the SQUEEZE attribute in a StyleSheet determines the column width in a report. You can use a SET parameter instead of a StyleSheet to set the value of SQUEEZE. If

there are conflicting StyleSheet and SET values, the StyleSheet overrides the SET.

When SQUEEZE is set to ON (the default), the StyleSheet column width is ignored. Column width is determined using your browser's default settings for HTML. For PDF, column width is based on the widest data value or column title, whichever is greater.

SQUEEZE may affect the way headings, footings, and column titles are displayed in your report.

Determine Column Width (HTML)

This syntax applies to an HTML report. For the syntax for a PDF or PS report, see [Determine Column Width \(PDF or PS\)](#).

```
[TYPE=REPORT,] SQUEEZE={ON|OFF}, $
```

where:

TYPE=REPORT

Applies the column width to the entire report. Not required, as it is the default.

ON

Determines column width based on the widest data value or column title, whichever is greater. ON is the default value.

For HTML reports, the Web browser shrinks the column width to the shortest column title or field value.

OFF

Determines column width based on the field format in the Master File. Blank spaces pad the column width up to the length of the column title or field format, whichever is greater.

Using Default Column Width (HTML)

This request uses SQUEEZE=ON (the default) for an HTML report. Column width is based on the wider of the data value or column title.

```

SET PAGE-NUM = OFF
TABLE FILE GGSALES
SUM UNITS DOLLARS
BY CATEGORY BY PRODUCT
ON TABLE HOLD FORMAT HTML
ON TABLE SET STYLE *
TYPE=REPORT, GRID=OFF, FONT=COURIER, $
ENDSTYLE
END

```

For Category, Unit Sales, and Dollar Sales, the column title is wider than the corresponding data values. For Product, the wider data values determine column width. The HTML report is:

<u>Category</u>	<u>Product</u>	<u>Unit Sales</u>	<u>Dollar Sales</u>
Coffee	Capuccino	189217	2381590
	Espresso	308986	3906243
	Latte	878063	10943622
Food	Biscotti	421377	5263317
	Croissant	630054	7749902
	Scone	333414	4216114
Gifts	Coffee Grinder	186534	2337567
	Coffee Pot	190695	2449585
	Mug	360570	4522521
	Thermos	190081	2385829

Determine Column Width (PDF or PS)

This syntax applies to a PDF or PS report. For the syntax for an HTML report, see [Determine Column Width \(HTML\)](#).

```
[TYPE=REPORT,] COLUMN=identifier, SQUEEZE={ON|OFF|width}, $
```

where:

TYPE=REPORT

Applies the column width to the entire report. Not required, as it is the default.

identifier

Selects a column. If you omit a column identifier, the value for SQUEEZE applies to all columns in a report. You can also use SET SQUEEZE to set the width of all columns.

ON

Determines column width based on the widest data value or column title, whichever is greater. ON is the default value.

OFF

Determines column width based on the field format in the Master File. Blank spaces pad the column width up to the length of the column title or field format, whichever is greater. OFF is the default value.

width

Is a measurement for the column width, specified with the UNITS attribute.

If the widest data value exceeds the specified measurement:

And the field is ...	The following appears ...
Alphanumeric	As much of the value as will fit in the specified width, followed by an exclamation mark (!) to indicate truncation.
Numeric	Asterisks (*) in place of the field value.

Determining Column Width (PDF)

This request uses SQUEEZE=2.5 to increase the default column width of the PRODUCT field in a PDF report. Note that this feature is used primarily for printed reports. Depending on your screen resolution, the column width may appear differently than it prints.

```
TABLE FILE GGSales
SUM UNITS
BY PRODUCT
ON TABLE SET PAGE-NUM OFF
ON TABLE HOLD FORMAT PDF
```



```
ON TABLE SET STYLE *
TYPE=REPORT, COLUMN=PRODUCT, SQUEEZE=2.5, $
ENDSTYLE
END
```

The PDF report is:

<u>Product</u>	<u>Unit Sales</u>
Biscotti	421377
Capuccino	189217
Coffee Grinder	186534
Coffee Pot	190695
Croissant	630054
Espresso	308986
Latte	878063
Mug	360570
Scone	333414
Thermos	190081

Wrapping and Justifying Report Components

You can position data within a report by specifying whether or not you wish to have data wrapping within a cell or by selecting a justification (right, left or center) of a column or heading.

Controlling Wrapping of Report Data

You can control the wrapping of report data in a report, thus preventing line breaks within report cells. When using HTML output, most Web browsers will, by default, wrap alphanumeric report data that does not fit on a single line in a cell.

This bumps the contents of the cell onto a second line. A Web browser wraps data based on its algorithmic settings. Use the WRAP attribute if you wish to suppress a Web browser from wrapping data.

By default, WRAP is set to ON for HTML output, allowing each individual browser to define the width of each column in the report. For PDF, PS, DHTML, PPT, and PPTX output, WRAP is set OFF by default. For these positioned output formats in which the location of each item in the report is explicitly defined, WRAP = ON is not a valid value, except when

specified for ACROSSVALUE. For other elements of the report, such as headers, footers, titles, or data, define the width of wrapped lines by using a numeric value, as in WRAP = n .

In PDF and PostScript report output, you can control the line spacing in wrapped lines by using the WRAPGAP attribute.

Wrapping Data in PDF Reports That Use the OVER Phrase

OVER allows the presentation of a single data record across multiple lines within a report. By default, when OVER is defined within a request, the report shifts from a columnar presentation to a row level presentation. The field titles are displayed to the left of each value, rather than at the top of each column. This layout was not designed to be aligned in any specific fashion but to allow for the presentation of multiple elements of data within a small area. In many cases, reports that place columns over each other use blank AS names in order to align the columns properly. You can use the WRAP attribute to wrap data in PDF reports that use OVER and this technique works well with blank AS names.

Wrapping Data in PDF Reports That Use the ACROSS Phrase

In a request that uses ACROSS, the output displays each value of the ACROSS field above the set of data columns applicable to that ACROSS value.

If the ACROSS value is longer than the width of its columns, you can wrap the ACROSS value within the width of its underlying columns.

By default, the width of each ACROSS value group (the ACROSS value and the data columns within) is defined as the largest of either the sum of the width of the data columns or the largest ACROSS value for that group. With wrapping, the size of each ACROSS wrap will be defined by the width defined based on this rule including all data columns and any non-wrapped across fields.

The width of each ACROSS column for a given ACROSS group is defined as the length of the largest value for that ACROSS group. A single width is used for each group so in groups where the values are shorter than the longest value, you will see a larger right gap within the cell.

For reports containing multiple ACROSS fields, you can wrap individual ACROSS fields or all of them. Each designated value will wrap within the defined ACROSS group.

For information about wrapping in Excel 2000 reports, see [Using Excel Display Formats: XLSX, EXL2K, EXL97](#).

Control Wrapping of Report Data Using a StyleSheet Attribute

To control wrapping of text, use the following syntax within a StyleSheet.

```
TYPE=type, [subtype,] WRAP=value, $
```

where:

type

Is the report component you wish to affect, such as REPORT, HEADING, or TITLE.

subtype

Is any additional attribute, such as COLUMN, ACROSS, ITEM, and so on, that is needed to identify the report component that you are formatting. See [Identifying Report Components](#) for more information about how to specify different report components.

value

Is one of the following:

- **ON**, which turns on the data wrapping. ON is the default value for HTML report output. For PDF, PS, DHTML, PPT, and PPTX report output, WRAP is set OFF by default. For these positioned output formats in which the location of each item in the report is explicitly defined, WRAP = ON is not a valid value, except when specified for ACROSSVALUE. For other elements of the report, such as headers, footers, titles, or data, define the width of wrapped lines by using a numerical value, as in WRAP = *n*. For HTML reports, WRAP is supported with all fields. For PDF reports, WRAP is supported only with embedded fields, not text.

i Note: This setting is not supported when using WRAP with OVER in PDF report output.

- **OFF**, which turns off data wrapping. This is the default value for PDF, PS, DHTML, PPT, and PPTX report output.
- ***n***, which represents a specific numeric value that the column width can be set to. The value represents the measure specified with the UNITS parameter. This setting is supported for wrapping data in PDF reports that use the OVER phrase.

i Note:

- WRAP=ON and WRAP=*n* are not supported with JUSTIFY.
- SET HTMLCSS=ON is required.

Allowing the Web Browser to Wrap Report Data

The following example, with WRAP=ON, wraps report data based on the Web browser's functionality. Note that because this value is the default, there is no need to specify WRAP=ON in the report request syntax.

i Note: The size of the browser window will impact if the data in the cells are wrapped.

```
TABLE FILE GGPRODS
PRINT SIZE UNIT_PRICE PACKAGE_TYPE
VENDOR_CODE VENDOR_NAME
BY PRODUCT_ID BY PRODUCT_DESCRIPTION
ON TABLE HOLD FORMAT HTML
ON TABLE SET STYLE *
TYPE=REPORT, GRID=OFF, $
ENDSTYLE
END
```

The output is:

PAGE 1						
Product Code	Product	Size	Unit Price	Package	Vendor ID	Vendor Name
B141	Hazelnut	16	58.00	Pounds	V082	Coffee Connection
B142	French Roast	12	81.00	Pounds	V083	European Specialities,
B144	Kona	12	76.00	Pounds	V081	Evelina Imports, Ltd

Notice that records in the Vendor Name column break to a second line.

Wrapping Columns With OVER

The following request against the GGPRODS data source places the column `VENDOR_NAME` on a new line with the `OVER` phrase. By default, wrap is turned off and must be defined explicitly within the StyleSheet:

```
TABLE FILE GGPRODS
PRINT SIZE UNIT_PRICE PACKAGE_TYPE OVER
VENDOR_NAME
BY PRODUCT_ID BY PRODUCT_DESCRIPTION
ON TABLE HOLD FORMAT PDF
ON TABLE SET STYLE *
TYPE=REPORT, SQUEEZE=ON, $
ENDSTYLE
END
```

The partial output is shown in the following image.

Product Code	Product	Size	Unit Price	Package	Vendor Name
B141	Hazelnut	16	58.00	Pounds	Coffee Connection
B142	French Roast	12	81.00	Pounds	European Specialities,
B144	Kona	12	76.00	Pounds	Evelina Imports, Ltd
F101	Scone	20	13.00	Case	Ridgewood Bakeries
F102	Biscotti	24	17.00	Case	Delancey Bakeries
F103	Croissant	20	28.00	Case	West Side Bakers
G100	Mug	24	26.00	Case	NY Ceramic Supply
G104	Thermos	16	96.00	Case	ThermoTech, Inc
G110	Coffee Grinder	12	125.00	Case	Appliance Craft
G121	Coffee Pot	8	140.00	Case	Appliance Craft

The following version of the request turns the wrapping on and sets a column width of 1.5 for the `VENDOR_NAME` column, which has been placed on a new line because of the `OVER` phrase:

```
TABLE FILE GGPRODS
PRINT SIZE UNIT_PRICE PACKAGE_TYPE OVER
```

```

VENDOR_NAME
BY PRODUCT_ID BY PRODUCT_DESCRIPTION
ON TABLE HOLD FORMAT PDF
ON TABLE SET STYLE *
TYPE=REPORT, COLUMN=VENDOR_NAME, WRAP=1.5,$
ENDSTYLE
END

```

The partial output shows that the VENDOR_NAME column now wraps. Notice that turning WRAP ON causes the OVER value, not the OVER TITLE, to wrap:

PAGE	1					
Product Code	Product					
B141	Hazelnut	Size 16	Unit Price	58.00	Package	Pounds
		Vendor Name	Coffee Connection			
B142	French Roast	Size 12	Unit Price	81.00	Package	Pounds
		Vendor Name	European Specialities,			
B144	Kona	Size 12	Unit Price	76.00	Package	Pounds
		Vendor Name	Evelina Imports, Ltd			
F101	Scone	Size 20	Unit Price	13.00	Package	Case
		Vendor Name	Ridgewood Bakeries			
F102	Biscotti	Size 24	Unit Price	17.00	Package	Case
		Vendor Name	Delancey Bakeries			
F103	Croissant	Size 20	Unit Price	28.00	Package	Case
		Vendor Name	West Side Bakers			
G100	Mug	Size 24	Unit Price	26.00	Package	Case
		Vendor Name	NY Ceramic Supply			

Control Spacing Between Wrapped Lines

You can use the WRAPGAP attribute in a StyleSheet to control the spacing between wrapped lines in PDF and PostScript report output.

```
type=component, WRAPGAP={ON|OFF|n}
```

where:

component

Is the component with wrapped lines.

ON

Does not leave any space between wrapped lines. ON is equivalent to specifying 0.0 for *n*.

OFF

Places wrapped data on the next line. OFF is the default value.

n

Is a number greater than or equal to zero that specifies how much space to leave between wrapped lines (using the unit of measurement specified by the UNITS attribute). Setting *n* to zero does not leave any space between wrapped lines, and is equivalent to specifying WRAPGAP=ON.

Specifying Spacing for Wrapped Lines

In the following request, wrapping is turned on for the ADDRESS_LN3 column of the report:

```
TABLE FILE EMPLOYEE
PRINT ADDRESS_LN3
BY LAST_NAME BY FIRST_NAME
WHERE LAST_NAME LE 'CROSS'
  ON TABLE HOLD FORMAT PDF
ON TABLE SET PAGE NOPAGE
ON TABLE SET STYLE *
type=report, grid=on, $
type=data, topgap=0.2, bottomgap=0.2, $
type=data, wrapgap=off, $
type=REPORT, column=ADDRESS_LN3, wrap=1.0 ,$
ENDSTYLE
END
```

With WRAPGAP=OFF, each wrapped line is placed on the next report line:

LAST NAME	FIRST NAME	ADDRESS LINE 1
BANNING	JOHN	FREEPORT NY 11520
BLACKWOOD	ROSEMARIE	NEW YORK NY 10001
		EDISON NJ 08817
		BROOKLYN NY 11210
CROSS	BARBARA	NEW YORK NY 10001
		FLUSHING NY 11354

With WRAPGAP=ON, the wrapped lines are placed directly under each other:

LAST_NAME	FIRST_NAME	ADDRESS_L!
BANNING	JOHN	FREEPORT NY 11520
BLACKWOOD	ROSEMARIE	NEW YORK NY 10001
		EDISON NJ 08817
		BROOKLYN NY 11210
CROSS	BARBARA	NEW YORK NY 10001
		FLUSHING NY 11354

Wrap ACROSS Values

Wrapping ACROSS Values is supported for HTML and PDF output formats.

```
TYPE=ACROSSVALUE, [ACROSS={fieldname|Nn|An}] WRAP={OFF|ON} , $
```

where:

ACROSS

If you have a request with multiple ACROSS fields, you can identify each field using the ACROSS identifier. You only need to include the ACROSS identifier if you have multiple ACROSS fields in your request.

fieldname

Specifies a horizontal sort row by its field name.

Nn

Identifies a column by its position in the report. To determine this value, count vertical sort (BY) fields, display fields, and ROW-TOTAL fields, from left to right, including NOPRINT fields.

An

Specifies a horizontal sort row by its position in the sequence of horizontal sort rows. To determine this value, count horizontal sort (ACROSS) fields. Cannot be combined with a field name specification in the same StyleSheet.

OFF

Turns off wrapping of the ACROSS values. OFF is the default value.

ON

Turns on wrapping of the ACROSS values.

i Note: WRAP=ON is not supported with JUSTIFY.

Wrapping ACROSS Values in PDF Report Output

In the following request against the GGPRODS data source, VENDOR_NAME is an ACROSS field:

```
TABLE FILE GGPRODS
HEADING
" PRODUCT REPORT"
" "
PRINT PRODUCT_ID UNIT_PRICE/D5
ACROSS VENDOR_NAME
BY SIZE
WHERE VENDOR_NAME GT 'B' AND VENDOR_NAME LT 'F'
ON TABLE PCHHOLDOLD FORMAT PDF
ON TABLE SET STYLE *
TYPE=REPORT, GRID=OFF, $
TYPE=REPORT, COLUMN=PRODUCT_ID, WIDTH=.25, $
TYPE=REPORT, COLUMN=UNIT_PRICE, WIDTH=.25, $
ENDSTYLE
END
```

As shown in the following image, the output is too wide for one panel because some of the ACROSS field values (vendor names) are longer than the sum of the product code and unit price columns under them.

PAGE 1.1						
PRODUCT REPORT						
Size	Code	Unit Price	Delancey Product Code	Bakeries Unit Price	European Product Code	Specialities, Unit Price
12	B142	81
16	B141	58
24	.	.	F102	17	.	.

The following version of the request wraps the ACROSS values (TYPE=ACROSSVALUE, WRAP=ON ,,\$):

```
TABLE FILE GGPRODS
HEADING
" PRODUCT REPORT"
" "
PRINT PRODUCT_ID UNIT_PRICE/D5
ACROSS VENDOR_NAME
BY SIZE
WHERE VENDOR_NAME GT 'B' AND VENDOR_NAME LT 'F'
ON TABLE HOLD FORMAT PDF
ON TABLE SET STYLE *
TYPE=REPORT, GRID=OFF, $
TYPE=REPORT, COLUMN=PRODUCT_ID, WIDTH=.25, $
TYPE=REPORT, COLUMN=UNIT_PRICE, WIDTH=.25, $
TYPE = ACROSSVALUE, WRAP=ON,$
ENDSTYLE
END
```

The report now fits on one panel, as shown in the following image.

PAGE 1								
PRODUCT REPORT								
Vendor Name Coffee Connection			Delancey Bakeries		European Specialities,		Evelina Imports, Ltd	
Size	Product Code	Unit Price	Product Code	Unit Price	Product Code	Unit Price	Product Code	Unit Price
12	B142	81	.	.
.	B144	76
16	B141	58
24	.	.	F102	17

OVER With Blank Column Titles

When OVER fields are defined with blank AS names (the value of the title of the column is set to empty ' '), they can be used to build a report with multiple data lines that present in an aligned grid fashion.

In this type of report, the column titles are usually indicated by adding multiple corresponding lines to the page headings rather than using the default titles that display to the left of the column field values. To present OVER fields with unique titles that take advantage of these new alignment features, you can place the column titles in independent fields and include them as fields within the given request.

Using OVER and WRAP With Blank AS Names

The following example demonstrates using OVER with blank AS names and WRAP to build a multi-data line report:

```
TABLE FILE GGPRODS
PRINT PACKAGE_TYPE AS '' SIZE AS '' OVER
VENDOR_NAME AS ''
BY PRODUCT_ID AS ''
BY PRODUCT_DESCRIPTION AS ''
ON TABLE SUBHEAD
"Gotham Grinds"
"Products Details"
HEADING
" Code <+0>Description<+0>Size <+0>Package"
" <+0>Vendor"
```

```

ON TABLE HOLD FORMAT PDF
ON TABLE SET STYLE *
TYPE=REPORT, FONT=ARIAL, SIZE=10, SQUEEZE=ON,$
TYPE=REPORT, COLUMN=PACKAGE_TYPE, SQUEEZE=.5 , $
TYPE=REPORT, COLUMN=VENDOR_NAME, WRAP=1 , $
TYPE=REPORT, BORDER=ON, $
TYPE=HEADING, LINE=1, ITEM=1, BORDER=ON, $
TYPE=HEADING, LINE=1, ITEM=2, BORDER=ON, POSITION=PRODUCT_DESCRIPTION,$
TYPE=HEADING, LINE=1, ITEM=3, BORDER=ON, POSITION=SIZE , $
TYPE=HEADING, LINE=1, ITEM=4, BORDER=ON, POSITION=PACKAGE_TYPE, $
TYPE=HEADING, LINE=2, ITEM=1, BORDER=ON, $
TYPE=HEADING, LINE=2, ITEM=2, BORDER=ON, POSITION=PACKAGE_TYPE,$
ENDSTYLE
END

```

On the report output, the Package Type and Size have been placed over the vendor name. The page heading has the corresponding titles. In the heading, the titles Package and Size have also been placed over the title Vendor Name. Note that the vendor name data wraps to maintain the alignment.

PAGE 1			
Gotham Grinds Products Details			
Code	Description	Package	Size
		Vendor	
B141	Hazelnut	Pounds	16
		Coffee Connection	
B142	French Roast	Pounds	12
		European Specialities,	
B144	Kona	Pounds	12
		Evelina Imports, Ltd	
F101	Scone	Case	20
		Ridgewood Bakeries	
F102	Biscotti	Case	24
		Delancey Bakeries	
F103	Croissant	Case	20
		West Side Bakers	

OVER and WRAP With Non-Blank Column Titles

The width of both the column title and the column data for each OVER value is determined by the single SQUEEZE or WRAP value. The title will automatically size to the same width as the wrapped data column. If the column title is wider than the width defined for the column wrap, you can either define a smaller title or add your titles as OVER fields that can be sized independently.

The following examples demonstrate how to build a report with OVER and WRAP that has column titles longer than the designated WRAP size.

Using OVER and WRAP With Column Titles

The following request defines two virtual fields to contain the column titles for the Product Name and Vendor Name fields. It then prints each virtual field next to its related data field and gives each a blank AS name. The first virtual field and data field are placed over the second virtual field and data field:

```
DEFINE FILE GGPRODS
TITLE_PROD/A20 = 'Product Description';
TITLE_VEND/A20 = 'Vendor Name';
END
TABLE FILE GGPRODS
PRINT TITLE_PROD AS '' PRODUCT_DESCRIPTION AS '' OVER
TITLE_VEND AS '' VENDOR_NAME AS ''
BY PRODUCT_ID AS ''
ON TABLE SUBHEAD
"Gotham Grinds"
"Products Details"
ON TABLE HOLD FORMAT PDF
ON TABLE SET STYLE *
TYPE=REPORT, FONT=ARIAL, SIZE=10, SQUEEZE=ON,$
TYPE=REPORT, COLUMN=TITLE_PROD , SQUEEZE=1.25 ,$
TYPE=REPORT, COLUMN=TITLE_VEND , SQUEEZE=1.25 ,$
TYPE=REPORT, COLUMN=PRODUCT_DESCRIPTION, WRAP=.75 ,$
TYPE=REPORT, COLUMN=VENDOR_NAME, WRAP=.75 ,$
TYPE=REPORT, BORDER=ON, $
ENDSTYLE
END
```

The output shows that the titles and data align properly.

PAGE 1

Gotham Grinds Products Details		
B141	Product Description	Hazelnut
	Vendor Name	Coffee Connection
B142	Product Description	French Roast
	Vendor Name	European Specialities,
B144	Product Description	Kona
	Vendor Name	Evelina Imports, Ltd
F101	Product Description	Scone
	Vendor Name	Ridgewood Bakeries
F102	Product Description	Biscotti
	Vendor Name	Delancey Bakeries
F103	Product Description	Croissant
	Vendor Name	West Side Bakers
G100	Product Description	Mug
	Vendor Name	NY Ceramic Supply
G104	Product Description	Thermos

Usage Notes for WRAPGAP

You can only specify WRAPGAP for columns that have wrapping enabled (WRAP attribute or parameter set to ON or a number). The TOPGAP and BOTTOMGAP attributes specify how much vertical space to leave above and below a report component. Increasing the values of these attributes makes a decrease in spacing between wrapped lines more noticeable.

Controlling Wrapping With Alternative Methods

In addition to the WRAP parameter, whether or not text wraps within a cell is affected by the SQUEEZE and GRID attributes. Both SQUEEZE and GRID can be used as SET commands or StyleSheet attributes. By specifying a setting other than the default value for these two attributes, the wrapping behavior in a browser is affected.

Set Commands that Affect Wrapping in a Report

The following SET commands affect the wrapping of data.

Command	Action
SET SQUEEZE=OFF	Forces the browser to display the entire column width and suppresses the wrapping of column data.
SET SQUEEZE=ON	Allows the browser to follow its own display behavior. If a browser's settings so specify, columns will be compressed to the length of the longest data value, and column data with embedded blanks will be wrapped.
SET GRID=OFF	Automatically suppresses the wrapping of data.
SET GRID=ON	Has no effect on either wrapping or compressing column width.

Control Wrapping Using SQUEEZE

SQUEEZE can be used as either a SET parameter or a StyleSheet attribute. To control the wrapping using SQUEEZE, use the following syntax within a StyleSheet.

```
TYPE =type, SQUEEZE=value, $
```

where:

type

Is the report component you wish to affect, such as REPORT, HEADING, or TITLE.

value

Is one of the following:

ON turns on data wrapping. This is the default for HTML output.

OFF turns off data wrapping. This is the default for PDF and PostScript.

n represents a specific numeric value to which the column width can be set (valid only in PDF and PostScript) The value represents the measure specified with the UNITS parameter.

Control Wrapping Using SQUEEZE as a SET Command

To suppress the wrapping feature in a report by setting the SQUEEZE parameter to OFF, use the following syntax

```
SET SQUEEZE=value, $
```

where:

value

Is one of the following:

ON turns on data wrapping.

OFF turns off data wrapping. This is the default.

n represents a specific numeric value to which the column width can be set (valid only in PDF and PS). The value represents the measure specified with the UNITS parameter.



Note: SQUEEZE turns off data wrapping. If a data value is wider than the specified width of the column, it will be hidden from view. Column width can be adjusted in Excel after the spreadsheet has been generated.

Usage Notes for WRAP and SQUEEZE

Most Web browsers-by default-determine the width of a report column using an internal algorithm. If a data value exceeds the column's width, the browser wraps that data onto the next line of the column. If you want to prevent these line breaks, you can override this browser behavior by using the WRAP StyleSheet attribute.

Specifying a width is supported in HTML reports that generate an internal cascading style sheet, as well as in PDF and PostScript reports.

If you do not specify the WRAP attribute in:

- An HTML report, it defaults to ON.
- A PDF report, it defaults to OFF.

Note that the WRAP and SQUEEZE attributes are incompatible: you should not apply both of them to the same report component.

The WRAP attribute is for alphanumeric columns, and is not supported for text (TX) columns.

Working With Multi-Table HTML Reports

- You can control where a report breaks using SET LINES or PAGE-BREAK in the request.
- If SET LINES=999999, the entire report is matched to a single displayed Web page, even if SET STYLEMODE=PAGED.
- ON *sortfield* PAGE-BREAK or BY *sortfield* PAGE-BREAK overrides a SET LINES command and breaks a report into multiple HTML tables whenever the sort field value changes.
- Column titles are generated for every PAGE-BREAK or according to the SET LINES parameter.
- When a report is broken into multiple HTML tables, the browser displays each table according to its own algorithm. Set SQUEEZE to OFF and/or WRAP to OFF to ensure that HTML tables are aligned consistently across pages.

Displaying a Multiple-Table HTML Report

In this request, each page is returned to the browser as a separate HTML table. SQUEEZE is set to OFF for consistent alignment of tables across pages.

```

SET STYLEMODE = PAGED
SET LINES = 12
TABLE FILE CENTORD
HEADING
"SALES OVER $200,000"
PRINT LINEPRICE AS 'Sales'
BY SNAME BY ORDER_NUM
WHERE LINEPRICE GT 200000
ON TABLE HOLD FORMAT HTML
ON TABLE SET STYLE *
TYPE=REPORT, GRID=OFF, SQUEEZE=OFF, $
ENDSTYLE
END

```

Two pages of the report follow, showing consistent alignment:

PAGE 19		
SALES OVER \$200,000		
<u>Store Name:</u>	<u>Order Number:</u>	<u>Sales</u>
Consumer Merchandise	57460	\$249,589.40
	73742	\$204,073.28
	74003	\$219,898.15
	77390	\$276,878.50
TV City	28605	\$210,990.34
	28696	\$203,493.89
PAGE 20		
SALES OVER \$200,000		
<u>Store Name:</u>	<u>Order Number:</u>	<u>Sales</u>
TV City	28870	\$237,226.33
	28891	\$202,903.10
	36819	\$260,287.49
		\$266,800.94
	37891	\$202,812.61
	38870	\$215,947.68

The same two pages illustrate inconsistent alignment with SQUEEZE set to ON:

PAGE 19		
SALES OVER \$200,000		
<u>Store Name:</u>	<u>Order Number:</u>	<u>Sales</u>
Consumer Merchandise	57460	\$249,589.40
	73742	\$204,073.28
	74003	\$219,898.15
	77390	\$276,878.50
TV City	28605	\$210,990.34
	28696	\$203,493.89
PAGE 20		
SALES OVER \$200,000		
<u>Store Name:</u>	<u>Order Number:</u>	<u>Sales</u>
TV City	28870	\$237,226.33
	28891	\$202,903.10
	36819	\$260,287.49
		\$266,800.94
	37891	\$202,812.61
	38870	\$215,947.68

Justifying Report Columns

You can adjust text within a column by specifying whether report columns are left justified, right justified, or centered. By default, alphanumeric columns are left justified, numeric columns are right justified, and heading and footing elements are left justified. However, you can change the default using the JUSTIFY attribute. You can also justify column titles using the /R /L and /C formatting options in the report request.

Justify a Report Column

To left justify, right justify, or center a column, use the following syntax within a StyleSheet.

```
TYPE=type, [subtype,] [COLUMN=column,] JUSTIFY=option, $
```

where:

type

Is the report component you wish to affect, such as REPORT, HEADING, or TITLE.

subtype

Is any additional attribute, such as COLUMN, ACROSS, ITEM, and so on, that is needed to identify the report component that you are formatting.

column

Is the column or group of columns you wish to justify. This attribute is only necessary if you wish to justify a specific column or set of columns. Omitting this attribute justifies the entire report.

option

Is the justification you wish to select:

LEFT specifies that the column will be left justified.

RIGHT specifies that the column will be right justified.

CENTER specifies that the column will be centered.

Justifying Data in a Report Column

The following example displays the StyleSheet syntax used to center the data in the Vendor Name column. The header is also center justified.

```
TABLE FILE GGPRODS
HEADING
"PRODUCT REPORT"
SUM UNITS BY PRODUCT_DESCRIPTION BY PRODUCT_ID BY VENDOR_NAME
ON TABLE HOLD FORMAT HTML
ON TABLE SET STYLE *
TYPE=REPORT, COLUMN=VENDOR_NAME, JUSTIFY=CENTER, $
TYPE=HEADING, JUSTIFY=CENTER, $
TYPE=REPORT, GRID=OFF, $
ENDSTYLE
END
```

The output is:

PRODUCT REPORT			
<u>Product</u>	<u>Product Code</u>	<u>Vendor Name</u>	<u>Unit Price</u>
Biscotti	F102	Delancey Bakeries	17.00
Coffee Grinder	G110	Appliance Craft	125.00
Coffee Pot	G121	Appliance Craft	140.00
Croissant	F103	West Side Bakers	28.00
French Roast	B142	European Specialities,	81.00
Hazelnut	B141	Coffee Connection	58.00
Kona	B144	Evelina Imports, Ltd	76.00
Mug	G100	NY Ceramic Supply	26.00
Scone	F101	Ridgewood Bakeries	13.00
Thermos	G104	ThermoTech, Inc	96.00

Justifying a Heading or Footing

You can left justify, right justify, or center a heading or footing in a StyleSheet. By default, a heading or footing is left justified. In addition, you can justify an individual line or lines in a multiple-line heading or footing.

To center a page heading or footing over the report data, you can use a legacy formatting technique that does not require a StyleSheet; simply include the CENTER option in a HEADING or FOOTING command.

Justification behavior in HTML and PDF. For HTML reports, justification is implemented with respect to the report's width. That means a centered heading is centered over the report content. In contrast, for PDF reports, the default justification area is the page width, rather than the report width. This results in headings and footings that are not centered on the report. In most cases, you can achieve justification based on report width in a PDF report by adding the command SET SQUEEZE=ON to your request. This command improves the appearance of the report by eliminating excessive white space between columns and implements justification over the report content. However, if the heading is wider than the report, it will be centered on the page, even when SQUEEZE=ON.

- ✔ **Tip:** You can also use justification syntax in combination with other StyleSheet syntax to align headings, footings, and items in them with other report elements, based on either unit measurements or relationships to other columns. For a summary of these options, see [Aligning Heading and Footing Elements](#).

Justify a Heading or Footing in a StyleSheet

```
TYPE = headfoot, [LINE = line_#,) JUSTIFY = option, $
```

where:

headfoot

Is the type of heading or footing. Valid values are TABHEADING, TABFOOTING, HEADING, FOOTING, SUBHEAD, and SUBFOOT.

line_#

Optionally identifies a line by its position in the heading or footing so that you can individually align it. If a heading or footing has multiple lines and you omit this option, the value supplied for JUSTIFY applies to all lines.

option

Is the type of justification. Valid values are:

LEFT which left justifies the heading or footing. This value is the default.

RIGHT which right justifies the heading or footing.

CENTER which centers the heading or footing.

Centering All Lines in a Multiple-Line Report Heading

This request centers all lines in a multiple-line report heading using the single StyleSheet attribute for the entire heading:

```

TABLE FILE GGSales
SUM BUDUNITS UNITS BUDDOLLARS DOLLARS
BY CATEGORY
ON TABLE SUBHEAD
"SALES REPORT"
"**(CONFIDENTIAL)**"
"December 2001"
ON TABLE SET PAGE-NUM OFF
ON TABLE HOLD FORMAT HTML
ON TABLE SET STYLESHEET *
TYPE = REPORT, GRID=OFF, $
TYPE = TABHEADING, JUSTIFY = CENTER, $
ENDSTYLE
END

```

The output is:

SALES REPORT				
(CONFIDENTIAL)				
December 2001				
<u>Category</u>	<u>Budget Units</u>	<u>Unit Sales</u>	<u>Budget Dollars</u>	<u>Dollar Sales</u>
Coffee	1385923	1376266	17293886	17231455
Food	1377564	1384845	17267160	17229333
Gifts	931007	927880	11659732	11695502

i Note: To run this report in PDF format, add the code ON TABLE SET SQUEEZE ON to eliminate excessive white space between columns and to center the heading over the report.

Justification Regions and Behavior

The region in which the text is justified depends on the relationship of the sizes of certain elements in the report:

- When SQUEEZE=ON, the maximum width of all the heading types in the report is calculated. This value is called MaxHeadWidth.

If MaxHeadWidth is less than or equal to the total width of the columns of the report, headings are justified in the space over the report columns.

If MaxHeadWidth exceeds the total width of the columns of the report, headings are centered and right-justified in the entire width of the page.

- When SQUEEZE=OFF, the maximum width of all the headings are not precalculated; headings are centered in the entire width of the page.

With a styled, multiple-panel report (in which the width exceeds one page), headings can only appear in the first panel. Thus, the preceding calculations deal with the total width of the columns in the first panel rather than the total width of all the columns in the report.

Justifying a Column Title

You can left justify, right justify, or center a column title for a display field, BY field, ACROSS field, or calculated value using a StyleSheet.

If a title is specified with an AS phrase in a request, or with the TITLE attribute in a Master File, that title will be justified, as specified for the field in StyleSheet syntax, if such syntax exists in the request.

Justification behavior in HTML and PDF. For HTML reports, justification is implemented with respect to the report's width. That means a centered column title is centered over a report column. In contrast, for PDF reports the default justification area is the page width, rather than the report width. This results in column titles that are not centered over the report column. You can achieve justification based on report width in a PDF report by adding the command SET SQUEEZE=ON to your request. This command improves the appearance of the report by eliminating excessive white space between columns and implements justification over the report content.

Justify a Column Title Using a StyleSheet

To justify a column title for a vertical sort column (generated by BY) or a display column (generated by PRINT, LIST, SUM, or COUNT), the StyleSheet syntax is

```
TYPE=TITLE, [COLUMN=column,] JUSTIFY=option, $
```

To justify a horizontal sort column title (generated by ACROSS), the StyleSheet syntax is

```
TYPE=ACROSSTITLE, [ACROSS=column,] JUSTIFY=option, $
```

To justify an ACROSS value or a ROW-TOTAL column title in an HTML report, use

```
TYPE=ACROSSVALUE, [COLUMN=column,] JUSTIFY=option, $
```

where:

TITLE

Specifies a vertical sort (BY) title or a display field title.

column

Specifies the column whose title you wish to justify. If you omit this attribute and value, the formatting will be applied to all of the report's column titles.

ACROSSTITLE

Specifies a horizontal sort (ACROSS) title.

ACROSSVALUE

Specifies a horizontal sort (ACROSS) value or a ROW-TOTAL column title.

option

Is the type of justification. Valid values are:

LEFT which left justifies the column title. This value is the default for an alphanumeric field.

RIGHT which right justifies the column title. This value is the default for a numeric or date field.

CENTER which centers the column title. You cannot center an ACROSSTITLE in a PDF report.

Using a StyleSheet to Justify Column Titles for Display and BY Fields

This request identifies each column by its field name and justifies each title separately.

```

TABLE FILE GGSTORES
PRINT STORE_NAME STATE AS 'St' BY ADDRESS1
WHERE STATE EQ 'CA'
ON TABLE SET PAGE-NUM OFF
ON TABLE HOLD FORMAT HTML
ON TABLE SET SQUEEZE ON
ON TABLE HOLD FORMAT HTML
ON TABLE SET STYLESHEET *
TYPE = REPORT, GRID=OFF, $
TYPE=TITLE, COLUMN=STORE_NAME, JUSTIFY=CENTER, $
TYPE=TITLE, COLUMN=STATE, JUSTIFY=RIGHT, $
TYPE=TITLE, COLUMN=ADDRESS1, JUSTIFY=CENTER, $
ENDSTYLE
END

```

The output is:

<u>Contact</u>	<u>Store Name</u>	<u>St</u>
JEFF DARFELL	GOTHAM GRINDS #1244	CA
PAT SMILEY	GOTHAM GRINDS #1040	CA

Using a StyleSheet to Justify a Column Title for ACROSS and ROW-TOTAL Fields

This request centers the column title, State, created by the ACROSS phrase over the two values (MT and WY) and the row total column title, Total by Gender, over the two row totals (Male Population and Female Population). Notice that each across value functions as a title for one or more columns in the report.

```

SET SQUEEZE = ON
TABLE FILE GGDEMOG
SUM MALEPOP98 FEMPOP98
ROW-TOTAL/D12 AS 'Total by Gender'
ACROSS ST
WHERE ST EQ 'WY' OR 'MT';
ON TABLE SET PAGE-NUM OFF
ON TABLE HOLD FORMAT HTML
ON TABLE SET STYLESHEET *

```

```

TYPE=REPORT, GRID=OFF, $
TYPE=ACROSSTITLE, JUSTIFY=CENTER, FONT='TIMES', SIZE=11, STYLE=BOLD, $
TYPE=ACROSSVALUE, COLUMN=N5, JUSTIFY=CENTER, $
ENDSTYLE
END

```

The output is:

		State			
MT		WY		Total by Gender	
Male Population	Female Population	Male Population	Female Population	Male Population	Female Population
426357	438836	245023	245897	671380	684733

Using a StyleSheet to Justify a Column Title for a Calculated Value

This request identifies the column title of the calculated value and left justifies it over the data.

```

TABLE FILE SALES
SUM UNIT_SOLD RETAIL_PRICE
COMPUTE REV/D12.2M = UNIT_SOLD * RETAIL_PRICE;
BY PROD_CODE
WHERE CITY EQ 'NEW YORK'
ON TABLE SET PAGE-NUM OFF
ON TABLE HOLD FORMAT HTML
ON TABLE SET STYLESHEET *
TYPE=REPORT, GRID=OFF, $
TYPE=TITLE, COLUMN=REV, STYLE=BOLD, JUSTIFY=LEFT, $
ENDSTYLE
END

```

The output is:

<u>PROD CODE</u>	<u>UNIT SOLD</u>	<u>RETAIL PRICE</u>	<u>REV</u>
B10	30	\$.85	\$25.50
B17	20	\$1.89	\$37.80
B20	15	\$1.99	\$29.85
C17	12	\$2.09	\$25.08
D12	20	\$2.09	\$41.80
E1	30	\$.89	\$26.70
E3	35	\$1.09	\$38.15

i Note: To run this report in PDF format, add the code `ON TABLE SET SQUEEZE ON` to eliminate excessive white space between columns and to justify column titles properly over the data.

Justifying a Label for a Subtotal or Grand Total

You cannot directly justify a customized label for a subtotal. However, in HTML or EXL2K report output, if columns are being totaled or subtotaled by the one subtotal command, and you do not specify a column in the StyleSheet, formatting is applied to the totals and subtotals of all columns and to the labeling text that introduces the total and subtotal values.

Justifying Subtotal and Grand Total Labels

This request subtotals the numeric columns in the report and right-justifies the output, including the text of the label that precedes the values for the subtotals. In this example, since numeric output is right justified by default, the justification specifications in the StyleSheet are used to reposition the labels. The default label for the automatically generated grand total is also right-justified.

```
TABLE FILE EMPLOYEE
SUM DED_AMT BY DED_CODE BY DEPARTMENT
BY BANK_ACCT
WHERE DED_CODE EQ 'CITY'
```

```

WHERE BANK_ACCT NE 0
ON DEPARTMENT SUBTOTAL AS 'Total City Deduction for'
ON TABLE SET PAGE-NUM OFF
ON TABLE HOLD FORMAT HTML
ON TABLE SET STYLESHEET *
TYPE=REPORT, GRID=OFF, $
TYPE=SUBTOTAL, STYLE=BOLD, JUSTIFY=RIGHT,$
TYPE=GRANDTOTAL, STYLE=BOLD, JUSTIFY=RIGHT,$
ENDSTYLE
END

```

The output is:

DED CODE	DEPARTMENT	BANK ACCT	DED AMT
CITY	MIS	40950036	\$14.01
		122850108	\$31.76
		163800144	\$82.69
	Total City Deduction for MIS		\$128.46
	PRODUCTION	160633	\$7.42
		136500120	\$18.26
		819000702	\$60.24
	Total City Deduction for PRODUCTION		\$85.92
	TOTAL		\$214.38

Alignment of Fields in Reports Using OVER in PDF Report Output

When columns are placed on report output, they are separated by gaps. You can control the size of the gaps between columns with the LEFTGAP and RIGHTGAP StyleSheet attributes.

By default, the gaps between columns are placed outside of the boundaries reserved for the fields on the report output. Therefore, the width or squeeze value defined for a field defines the size of the text area for the data value. It does not count the width of the gaps between columns. The bounding box used to define borders and background color is determined based on the data width plus the left gap plus the right gap.

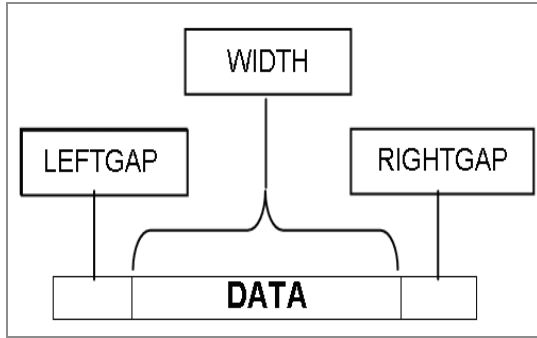

Gaps external to the column boundaries must be accounted for when you try to align fields in reports that use the OVER phrase.

This enhancement is designed to support the development of multi-row reports using blank AS names (column titles). Unless otherwise noted, these features work with non-blank titles, but they have not been designed to support alignment with non-blank column titles.

By default, column titles are placed to the left of the field values in a report using OVER. The OVER Title and the OVER Value each are measured by the combination of three parameters, LEFTGAP, WIDTH, and RIGHTGAP:

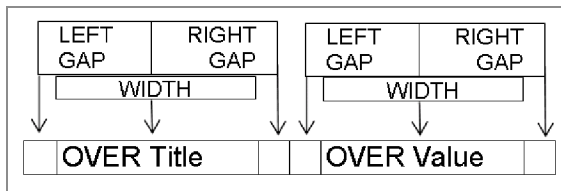

With OVER and blank AS names, each data value becomes a data cell that can be used to construct rows and columns within the data lines of the report. In order to align data values on a lower line with the columns above them, you must calculate widths for the lower-level columns that take into account the widths of the data above them plus the widths of all of the left gaps and right gaps in between.

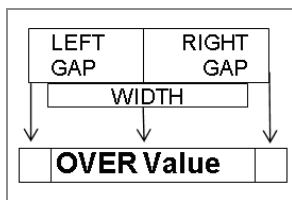

It can be complex to calculate how to size each column when aligning data and headings in reports using OVER. Each calculation of the column size must additionally account for the external left and right gap, and these gaps are cumulative as the number of columns on a given row increases.

Using the GAPINTERNAL=ON StyleSheet attribute, you can have the gaps placed within the column boundaries for PDF report output. This feature makes it much easier to align fields and headings in reports that use the OVER phrase to create multiple lines.

i **Note:** OVER is now supported with SQUEEZE.

Control GAP Placement on Reports

```
TYPE=REPORT, GAPINTERNAL={OFF|ON}
```

where:

OFF

Places the left and right gaps outside the defined field width. OFF is the default value.

ON

Places the left and right gaps internal to the defined field width.

Comparing External Gaps With Internal Gaps

With GAPINTERNAL=OFF, you must account for the accumulation of left and right gaps as well as the field widths when defining widths of stacked columns.

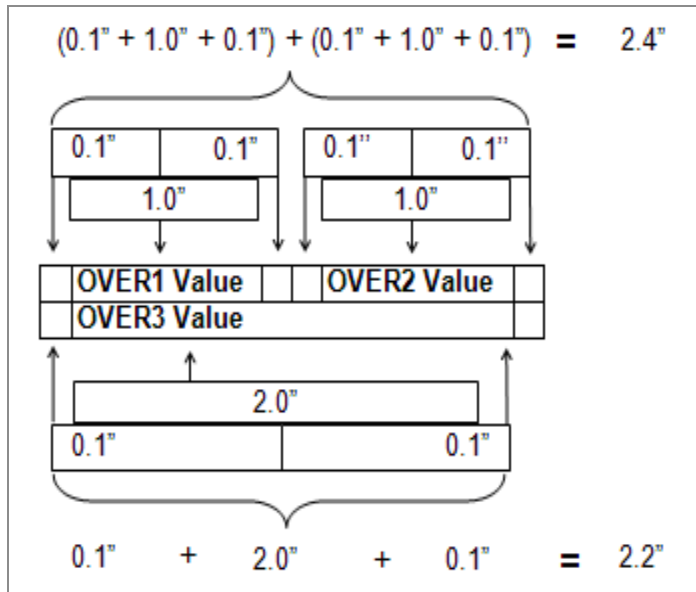

With GAPINTERNAL=ON, the defined WIDTH represents the entire space used by the given data cell or column. This takes the cumulative effect out as the OVER values proceed across a row.

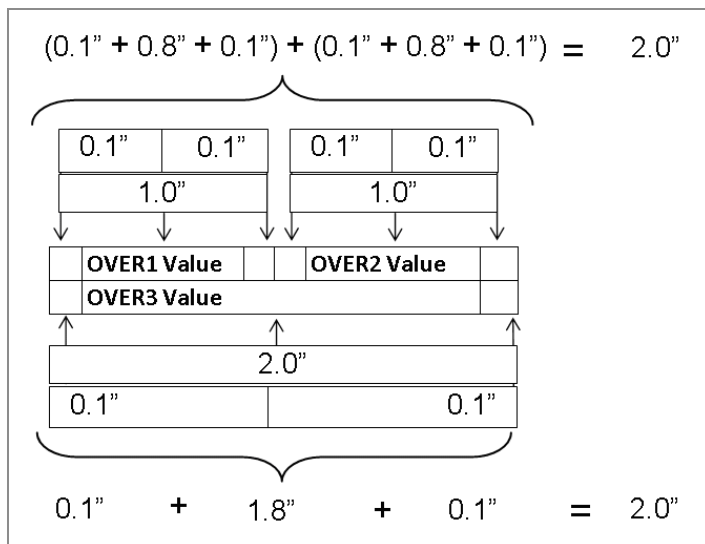

Using GAPINTERNAL in a Report

The following request against the GGSales data source places the PRODUCT field over the UNITS and DOLLARS fields and sets GAPINTERNAL to OFF:

```

SET LAYOUTGRID=ON
TABLE FILE GGSALES
"Product<+0>"
"Units<+0>Dollars"
SUM
PRODUCT AS ''
OVER
UNITS/D8C AS '' DOLLARS/D12.2CM AS ''
BY PRODUCT NOPRINT
ON TABLE HOLD FORMAT PDF
ON TABLE SET STYLE *
TYPE=REPORT, SQUEEZE=ON, FONT=ARIAL, SIZE=8, LEFTMARGIN=1, TOPMARGIN=1,
LEFTGAP=.1, RIGHTGAP=.1, GAPINTERNAL=OFF, $
TYPE=REPORT, BORDER=ON, $
TYPE=HEADING, BORDERALL=ON, $
TYPE=HEADING, LINE=1, ITEM=1, POSITION = PRODUCT, $
TYPE=HEADING, LINE=2, ITEM=1, POSITION = UNITS, $
TYPE=HEADING, LINE=2, ITEM=2, POSITION = DOLLARS, $
TYPE=REPORT, COLUMN=PRODUCT(2), SQUEEZE=2, $
TYPE=REPORT, COLUMN=UNITS, SQUEEZE=1, $
TYPE=REPORT, COLUMN=DOLLARS, SQUEEZE=1, $
ENDSTYLE
END

```

The widths specified for UNITS and DOLLARS are one inch each, while the PRODUCT field is specified to be two inches. With GAPINTERNAL=OFF, the LAYOUTGRID shows that the widths used to place the columns are greater than the widths specified in the request. The additional space presented by the external leftgap and rightgap accounts for this effect:

Product		Dollars
Units		
Biscotti		
421,377		\$5,263,317.00
Capuccino		
189,217		\$2,381,590.00
Coffee Grinder		
188,534		\$2,337,567.00
Coffee Pot		
190,695		\$2,449,585.00
Croissant		
630,054		\$7,749,902.00
Espresso		
308,988		\$3,906,243.00
Latte		
878,083		\$10,943,622.00
Mug		
360,570		\$4,522,521.00
Scone		
333,414		\$4,216,114.00
Thermos		
190,081		\$2,385,829.00

The heading borders are aligned on the right of the report because of the SQUEEZE=ON attribute in the StyleSheet. Extra space was added to the report to align the headings. If you change the StyleSheet declaration for the PRODUCTS field to JUSTIFY=RIGHT, you can see that the extra space prevents the product value from aligning with the dollars value:

PAGE 1

Product	
Units	Dollars
Biscotti	
421,377	\$5,283,317.00
Capuccino	
189,217	\$2,381,590.00
Coffee Grinder	
186,534	\$2,337,567.00
Coffee Pot	
190,895	\$2,449,585.00
Croissant	
630,054	\$7,749,902.00
Espresso	
308,986	\$3,908,243.00
Latte	
878,063	\$10,943,622.00
Mug	
360,570	\$4,522,521.00
Scone	
333,414	\$4,218,114.00
Thermos	
190,081	\$2,385,829.00

Changing the StyleSheet declaration to GAPINTERNAL=ON causes the specified widths to be used because the gaps are internal and are included in the specified values:

PAGE 1	
Product	
Units	Dollars
Biscotti	
421,377	\$5,263,317.00
Capuccino	
189,217	\$2,381,590.00
Coffee Grinder	
186,534	\$2,337,567.00
Coffee Pot	
190,695	\$2,449,585.00
Croissant	
630,054	\$7,749,902.00
Espresso	
308,986	\$3,906,243.00
Latte	
878,063	\$10,943,622.00
Mug	
360,570	\$4,522,521.00
Scone	
333,414	\$4,216,114.00
Thermos	
190,081	\$2,385,829.00

The following report output demonstrates that the values align properly even if the PRODUCT values are defined with JUSTIFY=RIGHT:

PAGE 1	
Product	
Units	Dollars
	Biscotti
421,377	\$5,283,317.00
	Capuccino
189,217	\$2,381,590.00
	Coffee Grinder
186,534	\$2,337,567.00
	Coffee Pot
190,695	\$2,449,585.00
	Croissant
630,054	\$7,749,902.00
	Espresso
308,986	\$3,906,243.00
	Latte
876,063	\$10,943,622.00
	Mug
360,570	\$4,522,521.00
	Scone
333,414	\$4,216,114.00
	Thermos
190,081	\$2,385,829.00

Aligning Heading and Footing Elements

To align text and data in headings and footings based on factors other than left, right, and center justification, consider the following descriptions before deciding which alignment method best suits your needs.

Alignment Method	Applies to ...	When to use...	Related Methods
1) StyleSheet Attributes: HEADALIGN COLSPAN	HTML EXL2K PDF	To align heading or footing items in HTML and EXL2K reports: If you expect to display reports in HTML or EXL2K format, use HEADALIGN options to align heading and footing items with either columns in	

Alignment Method	Applies to ...	When to use...	Related Methods
<p>JUSTIFY</p> <p>Details: See Aligning a Heading or Footing Element in an HTML Report.</p>		<p>the HTML table for the body of the report or with cells in an embedded HTML table. The browser handles alignment based on your specifications, without requiring unit measurements, which are required with WIDTH and JUSTIFY.</p> <p>To align heading or footing items in PDF reports: If you expect to display reports in PDF format, use the HEADALIGN=BODY option to align heading and footing items with columns in the report body.</p> <p>To specify a heading or footing item that spans multiple columns: You can combine HEADALIGN syntax with the COLSPAN attribute to achieve this result. For details, see Aligning a Heading or Footing Element Across Columns in an HTML Report.</p>	
<p>2) StyleSheet Attributes:</p> <p>WIDTH</p> <p>JUSTIFY</p> <p>Details: See Aligning Content in a Multi-Line Heading or Footing.</p>	<p>HTML</p> <p>PDF</p> <p>PS</p>	<p>For portability between HTML and PDF: To code a request that can be used without revision to produce identical output in HTML (with internal cascading style sheets) and in PDF, use WIDTH and JUSTIFY attributes in your StyleSheet. These settings can be applied to report, page, and sort headings and footings.</p> <p>To align heading or footing items: Used together, WIDTH and JUSTIFY allow you to align specific items in the heading, rather than entire headings or footings or entire heading or footing lines, where the implied justification width is the total width of the report panel. To right- or center-justify an</p>	<p>For an HTML, PDF, or EXL2K report, you can align specific items with HEADALIGN options.</p>

Alignment Method	Applies to ...	When to use...	Related Methods
		<p>item in a heading or footing, you must know the width of the area you want to justify it in. That information is provided by the WIDTH attribute.</p> <p>To align decimal points in a multi-line heading or footing: Use this technique to align decimal points in data that has varying numbers of decimal places. Define the width of the decimal item, then measure how far in from the right side of a column you want to position the decimal point. This places the decimal point in the same position in a column, regardless of the number of decimal places displayed to its right.</p>	
<p>3) StyleSheet Attribute:</p> <p>POSITION</p> <p>Details: See Positioning a Report Component.</p>	<p>PDF</p> <p>PS</p> <p>HTML (limited)</p>	<p>To set starting positions for headings or footings, or items within them: Use POSITION syntax to specify absolute and relative starting positions.</p> <p>In HTML, with an internal cascading style sheet, you can use POSITION to specify the starting point for a heading or footing line. You can also position an image in a heading or footing.</p> <p>To align heading and footing items with columns: Use POSITION syntax to align a heading item with a column position. For example, the syntax</p> <pre data-bbox="639 1566 1192 1686">TYPE=SUBHEAD, LINE=1, ITEM=3, POSITION=SALES, \$</pre> <p>places ITEM 3 of the sort heading at the</p>	<p>For a PDF report, you can accomplish most positioning with WIDTH and JUSTIFY.</p> <p>For an HTML report, you can align a heading item with a column by setting the HEADALIGN attribute to BODY.</p>

Alignment Method	Applies to ...	When to use...	Related Methods
		horizontal position where the column SALES is.	

Aligning a Heading or Footing Element in an HTML, EXL2K, or PDF Report

For HTML output (and for Excel 2000 output, which uses HTML alignment), you can position text and field items in headings and footings using HEADALIGN options. These options work within the limitations of HTML and browser technologies to provide a significant degree of formatting flexibility. Here is how HEADALIGN works.

For PDF output, you can use the HEADALIGN=BODY option to align heading and footing elements with the report body.

When HEADALIGN is set either to BODY or INTERNAL, output is laid out as an HTML table, which means that the browser determines the widths of the columns, thereby limiting the precise positioning of items. A basic rule governs the placement of heading or footing items: each item (text or embedded field) is placed in sequence into the next HTML table cell (<TD>). When HEADALIGN is set to NONE, the default, all the items in the heading or footing are strung together, inside a single cell. The browser stretches the heading table and the report table to accommodate the length of the text.

You can exercise control over the placement of items by overriding the default and choosing either BODY or INTERNAL:

- HEADALIGN=BODY puts heading item cells in the same HTML table as the body of the report, ensuring that the items in the heading and the data in the body of the report line up naturally since they have the same column widths. This is a simple and useful way to align heading items with columns of data. For example, suppose that you have computed subtotal values that you want to include in a sort footing. Using HEADLIGN=BODY, you can align the subtotals in the same columns as the data that is being totaled.
- HEADALIGN=INTERNAL puts the heading items in an HTML table of its own. This allows the heading items to be aligned vertically with each other, independent of the

data, since the widths of the heading items do not affect the width of the report columns and vice versa.

To break a text string into multiple parts for manipulation across columns in an HTML table, you can use `<+0>` spot markers in the request.

You can use HEADALIGN options in conjunction with the COLSPAN attribute. COLSPAN allows heading items to span multiple table columns, thereby providing additional flexibility in how you can design your headings. For details, see [Aligning a Heading or Footing Element in an HTML Report](#).

If there is more than one heading or footing type in a report, you can individually align any element within each of them using this syntax.

Align a Heading or Footing Element in an HTML Report

```
TYPE = {REPORT|headfoot}, HEADALIGN = option, $
```

where:

REPORT

Applies the chosen alignment to all heading and footing elements in a report.

headfoot

Is the type of heading or footing. Valid values are TABHEADING, TABFOOTING, HEADING, FOOTING, SUBHEAD, and SUBFOOT.

option

Is the type of alignment. Valid values are:

NONE which places heading items in an embedded HTML table inside the main (body) table, and strings together, in a single cell of the embedded table, all the heading items (text and fields) on a line. In PDF reports, this uses the default alignment heading alignment. This value is the default.

INTERNAL which places heading items in an HTML table of its own, with each item in a separate cell. This allows the heading items to be aligned vertically with each other,

independent of the data columns. The widths of the heading items do not affect the widths of the report columns and vice versa.

Note: HEADALIGN=INTERNAL is not supported in PDF reports.

BODY which aligns heading items with data columns by placing the items in the cells of the same HTML table as the body of the report. Since they have the same column widths, the items in the heading and the data in the body of the report line up naturally. For PDF output, this aligns the heading or footing elements with the data columns.

Note: HEADALIGN=BODY does not support paneling.

Aligning Elements in a Page Heading Using a Separate HTML Table

This request creates an embedded HTML table for a page heading, within the HTML table that governs alignment in the body of the report. This table has three rows and three columns to accommodate all the heading elements.

In the first line of the heading, a spot marker (<+0>) creates two text elements: the first element is blank, and the second element is Gotham Grinds, Inc. In the output, the second element appears in the second cell of the first row of the embedded table.

The second and fourth lines of the heading are blank.

The spot markers in the third line of the heading split it into three text elements: Orders Report, blank, Run on: &DATE. In the output, each element appears in a cell in the third row of the embedded HTML table, in the order specified in the request.

```
TABLE FILE GGORDER
HEADING
" <+0>Gotham Grinds, Inc."
" "
"Orders Report <+0> <+0> Run on: &DATE"
" "
PRINT ORDER_NUMBER ORDER_DATE STORE_CODE QUANTITY
BY PRODUCT_CODE BY PRODUCT_DESCRIPTION
IF RECORDLIMIT EQ 10
ON TABLE SET PAGE-NUM OFF
ON TABLE HOLD FORMAT HTML
ON TABLE SET STYLESHEET *
```

```

TYPE = REPORT, GRID = ON, $
TYPE = HEADING, HEADALIGN = INTERNAL, STYLE = BOLD, $
ENDSTYLE
END

```

GRID=ON in the request enables you to see the embedded HTML table for the heading, and the main HTML table for the body of the report. The positioning is maintained when the grid lines are hidden (off).

The output is:

Gotham Grinds, Inc.					
Orders Report			Run on: 06/19/02		
Product Code	Product	Order Number	Order Date	Store Code	Ordered Units
B141	Hazelnut	1	01/01/96	R1019	300
		2	01/01/96	R1019	117
B142	French Roast	3	01/01/96	R1019	126
		4	01/01/96	R1019	86
		5	01/01/96	R1019	49
G100	Mug	6	01/01/96	R1019	289
		7	01/01/96	R1019	231
G104	Thermos	8	01/01/96	R1019	347
G110	Coffee Grinder	9	01/01/96	R1019	265
G121	Coffee Pot	10	01/01/96	R1019	309

Aligning Subfooting Items With Report Columns in PDF Report Output

In the following request against the GGORDER data source, the subfooting has a text object ("Total") and a field object (ST.QUANTITY). The subfooting aligns the items with their report columns using TYPE=SUBFOOT, HEADALIGN=BODY ,\$. The text object is placed in the second report column using the <+0 spot marker, and the field object is placed in the third report column using another <+0 spot marker. Then the text item is left aligned (the default) with its report column. The field object is right aligned with its report column:

```

TABLE FILE GGORDER
PRINT QUANTITY
ORDER_NUMBER ORDER_DATE STORE_CODE
BY PRODUCT_CODE BY PRODUCT_DESCRIPTION
WHERE ORDER_DATE EQ '01/01/96'
WHERE STORE_CODE EQ 'R1019'
ON PRODUCT_CODE SUBFOOT
" <+0 Total: <+0 <ST.QUANTITY"
ON TABLE SET PAGE-NUM OFF
ON TABLE HOLD FORMAT PDF
ON TABLE SET STYLESHEET *
TYPE = SUBFOOT,HEADALIGN=BODY, $
TYPE = SUBFOOT,OBJECT=TEXT,STYLE = BOLD, $
TYPE = SUBFOOT,OBJECT=FIELD,JUSTIFY=RIGHT,STYLE = BOLD, $
ENDSTYLE
END

```

The output shows that the text *Total* is aligned with the product names and the subtotal field object is right aligned with the *Ordered Units* column.

<u>Product Code</u>	<u>Product</u>	<u>Ordered Units</u>	<u>Order Number</u>	<u>Order Date</u>	<u>Store Code</u>
B141	Hazelnut	300	1	01/01/96	R1019
		117	2	01/01/96	R1019
	Total:	417			
B142	French Roast	126	3	01/01/96	R1019
		86	4	01/01/96	R1019
		49	5	01/01/96	R1019
	Total:	261			
F101	Scone	37	11	01/01/96	R1019
		325	12	01/01/96	R1019
	Total:	362			
F102	Biscotti	399	13	01/01/96	R1019
	Total:	399			
F103	Croissant	93	14	01/01/96	R1019
		433	15	01/01/96	R1019
	Total:	526			
G100	Mug	289	6	01/01/96	R1019
		231	7	01/01/96	R1019
	Total:	520			
G104	Thermos	347	8	01/01/96	R1019
	Total:	347			
G110	Coffee Grinder	265	9	01/01/96	R1019
	Total:	265			
G121	Coffee Pot	309	10	01/01/96	R1019
	Total:	309			

Using OVER With HEADALIGN=BODY in a PDF Report

When aligning heading elements with the data line using HEADALIGN=BODY, the first row of fields serves as the anchor data row. Each heading line contains the number of columns presented in the anchor data row. Any additional columns that may appear on other data lines are not presented. If the first row of data contains fewer data value cells than other data rows, you will be unable to add alignment columns within headings for these additional columns.

In the following example, the first row (the anchor data row) contains a single value. Items placed in headings to correspond with column two that appears on subsequent rows are not displayed

```

SET LAYOUTGRID=ON
TABLE FILE GGSALES
"Product<+0>"
"Units<+0>Dollars"
SUM
PRODUCT AS ''
OVER
UNITS/D8C AS '' DOLLARS/D12.2CM AS ''
BY PRODUCT NOPRINT
ON TABLE HOLD FORMAT PDF
ON TABLE SET STYLE *
TYPE=REPORT, SQUEEZE=ON, FONT=ARIAL, SIZE=8, LEFTGAP=.1, RIGHTGAP=.1,
GAPINTERNAL=ON, $
TYPE=REPORT, BORDER=ON, $
TYPE=HEADING, BORDERALL=ON, HEADALIGN=BODY, $
TYPE=HEADING, LINE=1, ITEM=1, COLSPAN=2, WIDTH=2, JUSTIFY=LEFT, $
TYPE=HEADING, LINE=2, ITEM=1, WIDTH=1, JUSTIFY=LEFT, $
TYPE=HEADING, LINE=2, ITEM=2, WIDTH=1, JUSTIFY=LEFT, $
TYPE=REPORT, COLUMN=PRODUCT(2), SQUEEZE=2, $
TYPE=REPORT, COLUMN=UNITS, SQUEEZE=1, $
TYPE=REPORT, COLUMN=DOLLARS, SQUEEZE=1, $
ENDSTYLE
END

```

The output shows that the heading lines have one column each, while the data lines alternate between one column and two columns:

PAGE 1	
Product	
Units	
Biscotti	
421,377	\$5,263,317.00
Capuccino	
189,217	\$2,381,590.00
Coffee Grinder	
186,534	\$2,337,567.00
Coffee Pot	
190,695	\$2,449,585.00
Croissant	
630,054	\$7,749,902.00
Espresso	
308,986	\$3,906,243.00
Latte	
878,063	\$10,943,622.00
Mug	
360,570	\$4,522,521.00
Scone	
333,414	\$4,216,114.00
Thermos	

Aligning a Heading or Footing Element Across Columns in an HTML or PDF Report

With HEADALIGN=BODY, each heading or footing element is aligned with a data column in an HTML or PDF report; with HEADALIGN=INTERNAL, each element is continued in a column of an HTML table created and aligned specifically for the report heading or footing. By default, every heading or footing element (ITEM) is placed in the first available column. However, you can position an item to span multiple columns using the COLSPAN attribute. For details about HEADALIGN options, see [Aligning a Heading or Footing Element in an HTML Report](#).

You must specify the HEADALIGN and COLSPAN attributes in two separate StyleSheet declarations, since HEADALIGN applies to an entire heading or footing, while COLSPAN applies to a specific item in a heading or footing. This feature is supported for HTML only. PDF display format does not support the COLSPAN attribute.

Align a Heading or Footing Element Across Columns

```
TYPE = headfoot, [subtype,] COLSPAN = n, $
```

where:

headfoot

Is the type of heading or footing. Valid values are TABHEADING, TABFOOTING, HEADING, FOOTING, SUBHEAD, and SUBFOOT.

subtype

Are additional attributes that identify the report component. These options can be used separately or in combination, depending upon the degree of specificity required to identify an element. Valid values are:

LINE which identifies a line by its position in a heading or footing. Identifying individual lines enables you to format each line differently.

If a heading or footing has multiple lines and you apply a StyleSheet declaration that does not specify **LINE**, the declaration is applied to *all* lines. Blank lines are counted when interpreting the value of **LINE**.

OBJECT which identifies an element in a heading or footing as a text string or field value. Valid values are **TEXT** or **FIELD**. **TEXT** may represent free text or a Dialogue Manager ampersand (&) variable.

It is not necessary to specify **OBJECT=TEXT** unless you are styling both text strings and embedded fields in the same heading or footing.

ITEM which identifies an item by its position in a line. To divide a heading or footing line into items, you can use the <+0> spot marker.

To determine the **ITEM** for an **OBJECT**, follow these guidelines:

- When used with **OBJECT=TEXT**, count only the text strings from left to right.
 - When used with **OBJECT=FIELD**, count only values from left to right.
 - When used without **OBJECT**, count text strings and field values from left to right.
- If you apply a StyleSheet declaration that specifies **ITEM**, the number is counted

from the beginning of each line in the heading or footing, not just from the beginning of the first line.

COLSPAN

Is an attribute that aligns an item in the width spanned by multiple columns.

n

Is the column with which the specified item is aligned.

Comparing Output Generated With HEADALIGN Options

The requests that follow illustrate the differences in alignment with each HEADALIGN setting. The grid lines are exposed in the output to help distinguish the HTML table created for the body of the report from the embedded HTML tables created for the heading in some variations.

All HEADALIGN settings are compatible with COLSPAN syntax, which allows heading items to span multiple columns.

```
TABLE FILE CAR
SUM SALES BY COUNTRY BY CAR BY MODEL
ON COUNTRY SUBHEAD
"This is my subhead"
" "
"Country is:<COUNTRY Car is:<CAR"
"Model is:<MODEL"
IF COUNTRY EQ 'ENGLAND'
ON TABLE SET PAGE-NUM OFF
ON TABLE HOLD FORMAT HTML
ON TABLE SET STYLESHEET *
TYPE=SUBHEAD, HEADALIGN=OPTION, $
TYPE=SUBHEAD, LINE=1, ITEM=1, COLSPAN=4, JUSTIFY=CENTER, $
ENDSTYLE
END
```

HEADALIGN=NONE creates a separate table with default left alignment. The text and fields in each heading line are strung together in a single HTML table cell. In order to get this result, do not include the TYPE=SUBHEAD line that contains the COLSPAN=R, JUSTIFY=CENTER attributes in the StyleSheet:

TYPE=SUBHEAD, HEADALIGN=NONE, \$

COUNTRY	CAR	MODEL	SALES
This is my subhead			
Country is:ENGLAND Car is:JAGUAR Model is:V12XKE AUTO			
ENGLAND	JAGUAR	V12XKE AUTO	0
		XJ12L AUTO	12000
	JENSEN	INTERCEPTOR III	0
	TRIUMPH	TR7	0

HEADALIGN=NONE with COLSPAN

TYPE=SUBHEAD, HEADALIGN=NONE, \$

TYPE=SUBHEAD, LINE=1, ITEM=1, COLSPAN=4, JUSTIFY=CENTER, \$

COUNTRY	CAR	MODEL	SALES
This is my subhead			
Country is:ENGLAND Car is:JAGUAR Model is:V12XKE AUTO			
ENGLAND	JAGUAR	V12XKE AUTO	0
		XJ12L AUTO	12000
	JENSEN	INTERCEPTOR III	0
	TRIUMPH	TR7	0

The first line is centered across all four columns of the internal table, based on the COLSPAN=4 setting.

HEADALIGN=INTERNAL creates a separate HTML table. Columns are generated based on the number of items (text and fields) in the heading; each item is placed in a separate cell. These columns do *not* correspond to those in the HTML table for the report body.

TYPE=SUBHEAD, HEADALIGN=INTERNAL, \$

COUNTRY	CAR	MODEL	SALES
This is my subhead			
Country is:		ENGLAND	Car is: JAGUAR
Model is:		V12XKE AUTO	
ENGLAND	JAGUAR	V12XKE AUTO	0
		XJ12L AUTO	12000
	JENSEN	INTERCEPTOR III	0
	TRIUMPH	TR7	0

Country is aligned with Model in the first column of the internal table. The value of <COUNTRY is aligned with the value of <MODEL in the second column.

HEADALIGN=INTERNAL with COLSPAN

```
TYPE=SUBHEAD, HEADALIGN=INTERNAL, $
TYPE=SUBHEAD, LINE=1, ITEM=1, COLSPAN=4, JUSTIFY=CENTER, $
```

COUNTRY	CAR	MODEL	SALES
This is my subhead			
Country is:		ENGLAND	Car is: JAGUAR
Model is:		V12XKE AUTO	
ENGLAND	JAGUAR	V12XKE AUTO	0
		XJ12L AUTO	12000
	JENSEN	INTERCEPTOR III	0
	TRIUMPH	TR7	0

The first line is centered across all 4 columns of the internal table, based on the COLSPAN=4 setting.

HEADALIGN=BODY places the heading lines within the cells of the main HTML table. As a result, the columns of the heading correspond to the columns of the main table.

```
TYPE=SUBHEAD, HEADALIGN=BODY, $
```

COUNTRY	CAR	MODEL	SALES
This is my subhead			
Country is:	ENGLAND	Car is:	JAGUAR
Model is:	V12XKE AUTO		
ENGLAND	JAGUAR	V12XKE AUTO	0
		XJ12L AUTO	12000
	JENSEN	INTERCEPTOR III	0
	TRIUMPH	TR7	0

Country is aligned with Model in the first column of the main (body) HTML table. The value of <COUNTRY is aligned with the value of <MODEL in the second column.

HEADALIGN=BODY with COLSPAN

```
TYPE=SUBHEAD, HEADALIGN=BODY, $
TYPE=SUBHEAD, LINE=1, ITEM=1, COLSPAN=4, JUSTIFY=CENTER, $
```

COLSPAN controls the cross-column alignment of the first row of the heading.

COUNTRY	CAR	MODEL	SALES
This is my subhead			
Country is:	ENGLAND	Car is:	JAGUAR
Model is:	V12XKE AUTO		
ENGLAND	JAGUAR	V12XKE AUTO	0
		XJ12L AUTO	12000
	JENSEN	INTERCEPTOR III	0
	TRIUMPH	TR7	0

Aligning and Styling a Text Field in a Sort Footing

This example uses the following Master File and MODIFY procedure to create a data source with a text field:

Master File:

```

FILENAME = TXTFLD, SUFFIX = FOC,$
SEGNAME=TXTSEG, SEGTYPE = S1,$
  FIELDNAME = CATALOG, FORMAT = A10, $
  FIELDNAME = TEXTFLD,      FORMAT = TX50,$

```

MODIFY Procedure to create the TXTFLD data source:

```

CREATE FILE TXTFLD
MODIFY FILE TXTFLD
FIXFORM CATALOG/10 TEXTFLD
DATA
COURSE100 This course provides the junior programmer
with the skills needed to code simple reports.>%$
COURSE200 This course provides the advanced programmer with
techniques helpful in developing complex
applications.>%$
END

```

This request applies boldface type to the second line of a multiple-line sort footing, which includes the text Course Description as well as the text of the field TEXTFLD. Line 1 of the sort footing is the text Evening Course.

```

TABLE FILE TXTFLD
BY CATALOGA SUBFOOT
"Evening Course"
"Course Description: <TEXTFLD"
ON TABLE SET PAGE-NUM OFF
ON TABLE HOLD FORMAT HTML
ON TABLE SET STYLESHEET *
TYPE = REPORT, GRID = OFF, $
TYPE = SUBFOOT, HEADALIGN = BODY, $
TYPE = SUBFOOT, LINE = 2, STYLE = BOLD, $
ENDSTYLE
END

```

The output is:

CATALOG

COURSE100

Evening Course

Course Description: This course provides the junior programmer with the skills needed to code simple reports.

COURSE200

Evening Course

Course Description: This course provides the advanced programmer with techniques helpful in developing complex applications.

If the StyleSheet instead identifies the text field as an object for styling

```
TYPE = SUBFOOT, HEADALIGN = BODY, $
TYPE = SUBFOOT, LINE = 2, OBJECT = FIELD, STYLE = BOLD, $
```

then only the text in TEXTFLD is bold:

CATALOG

COURSE 100

Evening Course

Course Description: **This course provides the junior programmer with the skills needed to code simple reports.**

COURSE 200

Evening Course

Course Description: **This course provides the advanced programmer with techniques helpful in developing complex applications.**

Aligning a Field Value Across Multiple Columns in a PDF Report

In this request, HEADALIGN=BODY aligns the sort footing in the same grid as the body of the report. COLSPAN=5 positions the first item in the sort footing (the text *Total*) in the fifth column of the report output. The second item in the sort footing (the field <ST.QUANTITY) is positioned in the next available column. The subfooting items are right justified.

The HEADALIGN attribute is on a separate line from the COLSPAN attribute because it applies to the entire sort footing (and consequently to both items), whereas COLSPAN applies only to the text item *Total*.

```
TABLE FILE GGORDER
PRINT ORDER_NUMBER ORDER_DATE STORE_CODE QUANTITY
BY PRODUCT_CODE BY PRODUCT_DESCRIPTION
WHERE ORDER_DATE EQ '01/01/96'
WHERE STORE_CODE EQ 'R1019'
ON PRODUCT_CODE SUBFOOT
"Total:<ST.QUANTITY"
""
ON TABLE SET PAGE-NUM OFF
ON TABLE HOLD FORMAT PDF
ON TABLE SET STYLESHEET *
TYPE=REPORT, FONT=ARIAL, SQUEEZE=ON,$
TYPE = SUBFOOT, HEADALIGN = BODY, JUSTIFY = RIGHT, STYLE = BOLD, $
TYPE = SUBFOOT, ITEM=1, COLSPAN = 5, $
ENDSTYLE
END
```

The output shows that the first item in the sort footing (the text *Total*) is in the fifth column of the report output. The second item in the sort footing (the field <ST.QUANTITY) is positioned in the next available column.

Product Code	Product	Order Number	Order Date	Store Code	Ordered Units
B141	Hazelnut	1	01/01/96	R1019	300
		2	01/01/96	R1019	117
				Total:	417
B142	French Roast	3	01/01/96	R1019	126
		4	01/01/96	R1019	86
		5	01/01/96	R1019	49
				Total:	261
F101	Scone	11	01/01/96	R1019	37
		12	01/01/96	R1019	325
				Total:	362
F102	Biscotti	13	01/01/96	R1019	399
				Total:	399
F103	Croissant	14	01/01/96	R1019	93
		15	01/01/96	R1019	433
				Total:	526
G100	Mug	6	01/01/96	R1019	289
		7	01/01/96	R1019	231
				Total:	520
G104	Thermos	8	01/01/96	R1019	347
				Total:	347
G110	Coffee Grinder	9	01/01/96	R1019	265
				Total:	265
G121	Coffee Pot	10	01/01/96	R1019	309
				Total:	309

Aligning Content in a Multi-Line Heading or Footing

The HEADALIGN and COLSPAN syntax described in [Aligning a Heading or Footing Element in an HTML Report](#) is specific to HTML reports. This topic describes how you can design reports that are printable across HTML and PDF formats. Using the WIDTH and JUSTIFY syntax in a StyleSheet, you can:

- Align vertical sets of text or data as columnar units.
- Combine columnar formatting with line-by-line formatting. See [Combining Column and Line Formatting in Headings and Footings](#).
- Align decimal points when the data displayed has varying numbers of decimal places. See [Aligning Decimals in a Multi-Line Heading or Footing](#).

You can apply WIDTH and JUSTIFY attributes to report headings and footings, page headings and footings, and sort headings and footings, using either mono-space or proportional fonts.

These techniques rely on internal cascading style sheets, which support FOCUS StyleSheet attributes that were not previously available for HTML reports. The syntax associated with these techniques resolves the problem of having to format headings differently for HTML reports (using HEADALIGN and COLSPAN) and PDF and PS reports (using POSITION and spot markers).

While the WIDTH and JUSTIFY attributes are particularly useful when you need to format a multi-line heading or footing, or align stacked decimals, you can also use this syntax to position items in an individual heading or footing line.

Align Heading Text and Data in Columns

For a multi-line report or page heading or footing, use the syntax:

```
TYPE=headfoot, WRAP=OFF, $
TYPE=headfoot, [LINE=line_#,) ITEM=item_#, [OBJECT={TEXT|FIELD}],
WIDTH=width, [JUSTIFY=option,] $
```

For a multi-line sort heading or footing, use the syntax

```
TYPE=headfoot, WRAP=OFF, $
TYPE={SUBHEAD|SUBFOOT}, [BY=sortfield] [LINE=line_#,,] ITEM=item_#,
[OBJECT={TEXT|FIELD}], WIDTH=width, [JUSTIFY=option,] $
```

where:

headfoot

Is the type of heading or footing. Valid values are TABHEADING, TABFOOTING, HEADING, FOOTING, SUBHEAD, and SUBFOOT.

sortfield

When TYPE=SUBHEAD or SUBFOOT, you can specify alignment for the sort heading or sort footing associated with a particular sort field. If no sort field is specified, formatting is applied to the sort headings or footings associated with all sort fields.

LINE

Is an optional entry that identifies a line by its position in a heading or footing. Identifying individual lines enables you to format each one differently.

If a heading or footing has multiple lines and you apply a StyleSheet declaration that does not specify LINE, the declaration is applied to *all* lines. Blank lines are counted when interpreting the value of LINE.

You can use LINE in combination with ITEM.

ITEM

Is a required entry when you are using WIDTH to control alignment. An item can identify either:

- A vertical set of text or data that you wish to align as a columnar unit. You must identify each vertical unit as an item.
- An item's position in a line. You must identify each line element as an item. See [Line and Item Formatting in a Multi-Line Heading or Footing](#) for information about acceptable variations.

You can use either or both approaches for a single heading or footing.

To divide a heading or footing line into items, you can use the <+0> spot marker. The number of items you can identify is limited by the cumulative widths of the items in the heading or footing, within the physical boundaries of the report page.

You can use ITEM in conjunction with OBJECT to refine the identification of an element whose width you want to define. To determine the ITEM for an OBJECT, follow these guidelines:

- When used with OBJECT=TEXT, count only the text strings from left to right.
- When used with OBJECT=FIELD, count only values from left to right.
- When used without OBJECT, count text strings and field values from left to right.

If you apply a StyleSheet declaration that specifies ITEM, the number is counted from the beginning of each line in the heading or footing, not just from the beginning of the first line

OBJECT

Is an optional entry that identifies an element in a heading or footing as a text string or field value. Valid values are TEXT or FIELD. TEXT may represent free text or a Dialogue Manager ampersand (&) variable.

It is not necessary to specify OBJECT=TEXT unless you are styling both text strings and embedded fields in the same heading or footing.

width

Is the measurement expressed in units (inches by default), which is required to accommodate the longest text string or field value associated with a numbered item. For details, see [Measure for Column Width and Decimal Alignment](#).

option

Is the type of justification. Valid values are:

LEFT which left justifies the heading or footing. This value is the default.

RIGHT which right justifies the heading or footing.

CENTER which centers the heading or footing.

DECIMAL (n)

Is the measurement expressed in units (inches by default), which specifies how far in from the right side of a column to place the decimal point. With this specification, you can locate the decimal point in the same position within a column, regardless of the number of decimal places displayed to its right.

The measurement will be a portion of the width specified for this item. For details, see [Measure for Column Width and Decimal Alignment](#).

Line and Item Formatting in a Multi-Line Heading or Footing

Line formatting maximizes your control over the items you identify on each line:

- You can align and stack the same number of items with uniform widths. For example,

Line 1	Item 1	item 2	Item 3
Line 2	Item 1	Item 2	Item 3

- You can also align different numbers of items as long as the items on each line have the same starting point and the same cumulative width.

Line 1	Item 1	item 2	
Line 2	Item 1	Item 2	Item 3

Do not use HEADALIGN or COLSPAN syntax, which are specific to HTML reports and may conflict with WIDTH and JUSTIFY settings.

For HTML reports, turn WRAP OFF (ON is the default) to ensure proper processing of WIDTH and JUSTIFY.

Aligning Data and Text in a Multi-Line Heading or Footing

In the following free-form report, content is defined entirely in the sort heading, where text and data are stacked to support comparison among manufacturing plants. Each set of data is aligned vertically, to appear as a column. To achieve this affect, each vertical unit is identified as an item: the first column of text is *item 1*; the next column of data is *item 2*, and so on.

Note especially the last column, in which decimal data with different numbers of decimal places is lined up on the decimal point to facilitate reading and comparison.

Plant:	BOS	Quantity:	1,033,818
Order Date:	2002/01/02	Cost of Goods:	173,484,823.50000
Store Code:	1003MD	Line Total:	\$262,433,960.63
Plant:	DAL	Quantity:	390,844
Order Date:	2002/01/02	Cost of Goods:	64,880,802.75000
Store Code:	2011TX	Line Total:	\$97,751,846.65
Plant:	LA	Quantity:	229,256
Order Date:	2002/01/02	Cost of Goods:	37,788,489.00000
Store Code:	999999	Line Total:	\$57,507,080.82
Plant:	ORL	Quantity:	386,909
Order Date:	2002/01/02	Cost of Goods:	64,702,888.50000
Store Code:	3002FL	Line Total:	\$97,616,855.94
Plant:	SEA	Quantity:	86,680
Order Date:	2002/01/02	Cost of Goods:	15,066,598.50000
Store Code:	1003WA	Line Total:	\$22,742,743.88
Plant:	STL	Quantity:	776,743
Order Date:	2002/01/02	Cost of Goods:	129,000,075.75000
Store Code:	3002IL	Line Total:	\$195,970,536.09

The chart below breaks out the structure of the previous report:

Item1:	Item 2:	Item 3:	Item 4:
Text	Data values	Text	Values with decimal places
Plant	BOSDAL, and so on	Quantity	<i>n,nnn,nnn</i>
Order Date	2002/01/02	Cost of Goods	<i>nnn,nnn,nnn.ddddd</i>
Store Code	1003MD	Line Total	<i>\$nnn,nnn,nnn.dd</i>

For each item, you specify the width of the column and the justification of its content, as illustrated in the following code.

```

DEFINE FILE CENTORD
COST/D20.5 = LINE_COGS * .75 ;
END

TABLE FILE CENTORD
BY PLANT NOPRINT SUBHEAD
"Plant: <PLANT Quantity: <QUANTITY"
"Order Date: <ORDER_DATE Cost of Goods: <COST"
"Store Code: <STORE_CODE Line Total: <LINEPRICE"
ON TABLE SET PAGE-NUM OFF
ON TABLE SET HTMLCSS ON
ON TABLE HOLD FORMAT HTML
ON TABLE SET STYLESHEET *
TYPE=REPORT, FONT='TIMES', $
TYPE=REPORT, GRID=OFF, $
TYPE=SUBHEAD, ITEM=1, WIDTH=1.00, JUSTIFY=RIGHT, $
TYPE=SUBHEAD, ITEM=2, WIDTH=1.25, JUSTIFY=RIGHT, $
TYPE=SUBHEAD, ITEM=3, WIDTH=1.25, JUSTIFY=RIGHT,$
TYPE=SUBHEAD, ITEM=4, WIDTH=2.0, JUSTIFY=DECIMAL
(.6),$
ENDSTYLE
END

```

This procedure produces a three-line sort heading, broken out as four items, each with a measured width and defined justification. The decimal item (4) uses a variation on standard justification to line up the decimal points. For details, see [Align Heading Text and Data in Columns](#) and [Aligning Decimals in a Multi-Line Heading or Footing](#).

Note: To take advantage of this feature for an HTML report, turn on internal cascading style sheets (SET HTMLCSS=ON). This command enables FOCUS StyleSheet attributes that were not previously available for HTML reports. This line of code is ignored for a PDF report.

Aligning Decimals in a Multi-Line Heading or Footing

The ability to align heading content in a multi-line heading based on width and justification values has special benefit in reports that contain data with different numbers of decimal places. For example, if a figure is in dollars, it is formatted with a decimal point and two places for zeroes; if in Swiss francs, it is formatted with a decimal place and four zeroes; if

in yen, the decimal is at the end with no zeroes. In addition, sometimes the currency or units do not vary, but the number of digits of decimal precision varies.

By aligning the decimal points in a vertical stack, you can more easily read and compare these numbers, as illustrated in the following output:

Floating decimal points		Aligned decimal points	
Bond ----- --	Face Value ----- 22375.5784596	Bond ----- --	Face Value ----- 22375.5784596
Galosh Ltd.	1212345.457	Galosh Ltd.	1212345.457
Mukluk Inc.	232.45484	Mukluk Inc.	232.45484
Overshoe Inc.		Overshoe Inc.	

The technique uses a width specification for the item that contains decimals, combined with a variation on standard left/right/center justification to achieve the proper decimal alignment. For the syntax that generates this output, see [Align Heading Text and Data in Columns](#).

Measure for Column Width and Decimal Alignment

Measuring Width. Determining the width of a heading or footing item is a three-step process:

1. Identify the maximum number of characters in a text string or field.
2. For a text string, simply count the characters. For a field, refer to the format specification in the Master File or in a command such as a DEFINE.
3. Measure the physical space in units (for example, in inches) that is required to display the number of characters identified in step 1, based on the size of the font you are using. For example, the following value of the COUNTRY field would measure as follows:

Font	Font size	Comparison	Inches
Helvetica	10	England	.5
Times New Roman	10	England	.44
Courier	10	England	.56

 **Tip:** Consider using a consistent set of fonts in your reports to make your measurements reusable.

Measuring for Decimal Alignment. After you have determined the width of an item, you can do a related measurement to determine the physical space required to display decimal data with a varying number of digits to the right of the decimal point.

1. Determine the maximum number of decimal places you need to accommodate to the right of the decimal place, plus the decimal point itself.
2. Measure the physical space in units (for example, in inches) that is required to display the number of characters identified in step 1, based on the size of the font you are using.

Combining Column and Line Formatting in Headings and Footings

By combining column and line formatting, you can create complex reports in which different ranges of lines in the same heading or footing have different numbers of aligned columns in different locations.

Combining Column and Line Formatting to Align Items in a Sort Heading

This request produces a free-form report in which content is defined in a seven-line sort heading. Data is stacked in two groupings:

- The first grouping identifies the regions and state.
- The second grouping provides other information for each region/state pair.

Although this is a single sort heading, our goal is to format the information in each grouping a bit differently to provide emphasis and facilitate comparison. The request also demonstrates a coding technique that makes formatting changes easier for the report designer. See the annotations following the code for details.

As you review the sample request, keep in mind that a heading can contain two kinds of items: text and embedded fields. A text item consists of any characters, even a single blank, between embedded fields and/or spot markers. In particular, if you have a single run of text that you want to treat as two items, you can separate the two items using a <+0> spot marker. For example, in the heading line:

```
" <+0>Region:<REGION"
```

item #1 is a single blank space.

item #2, separated by the <+0> spot marker, is the text Region:

item #3 is the embedded field <REGION.

Request and annotations:

```
TABLE FILE CENTORD
BY REGION NOPRINT SUBHEAD
1. " <+0>Region:<REGION"
2. " <+0>State :<STATE"
   " "
3. "Product Number:<PROD_NUM <+0>Quantity:<QUANTITY"
4. "Product Type:<PRODCAT <+0>Price:<PRICE"
5. "Product Category:<PRODTYPE <+0>Cost:<COST"
   " "
ON TABLE SET PAGE-NUM OFF
6. ON TABLE SET HTMLCSS ON
ON TABLE HOLD FORMAT HTML AS NF958055
ON TABLE SET STYLESHEET *
TYPE=REPORT, FONT='TIMES', $
TYPE=REPORT, GRID=OFF, $
-* Bottom section of subhead:
7. TYPE=SUBHEAD, ITEM=1, WIDTH=1.25, JUSTIFY=RIGHT, $
8. TYPE=SUBHEAD, ITEM=2, WIDTH=1.00, JUSTIFY=RIGHT, $
9. TYPE=SUBHEAD, ITEM=3, WIDTH=1.0, $
10. TYPE=SUBHEAD, ITEM=4, WIDTH=1.00, JUSTIFY=RIGHT,$
11. TYPE=SUBHEAD, ITEM=5, WIDTH=1.5, JUSTIFY=DECIMAL(.6),$
```



```

    -* Top section of subhead (overrides above ITEM defaults
    -* for lines 1 and 2):
12. -SET &INDENT = 1.5;
13. TYPE=SUBHEAD, LINE=1, ITEM=1, WIDTH=&INDENT, $
14. TYPE=SUBHEAD, LINE=1, ITEM=2, WIDTH=1, JUSTIFY=LEFT, $
15. TYPE=SUBHEAD, LINE=1, ITEM=3, SIZE=14, WIDTH=2, JUSTIFY=LEFT, $
16. TYPE=SUBHEAD, LINE=2, ITEM=1, WIDTH=&INDENT, $
17. TYPE=SUBHEAD, LINE=2, ITEM=2, WIDTH=1, JUSTIFY=LEFT, $
18. TYPE=SUBHEAD, LINE=2, ITEM=3, WIDTH=1.25, JUSTIFY=LEFT, $
    ENDSTYLE
    END

```

Here is the output generated by this request. It highlights the key information and its relationship by aligning text and data, including decimal data in which decimal points are aligned for easy comparison.

	Region:	EAST		
	State :	MD		
Product Number:	1034		Quantity:	1,043,507
Product Type:	PDA Devices		Price:	5,991,793.00
Product Category:	Digital		Cost:	4,321,273.00
	Region:	NORTH		
	State :	IL		
Product Number:	1036		Quantity:	707,199
Product Type:	PDA Devices		Price:	1,484,680.00
Product Category:	Digital		Cost:	1,064,154.00
	Region:	SOUTH		
	State :	FL		
Product Number:	1034		Quantity:	827,871
Product Type:	PDA Devices		Price:	1,605,248.00
Product Category:	Digital		Cost:	1,152,895.00
	Region:	WEST		
	State :	WA		
Product Number:	1036		Quantity:	325,673
Product Type:	PDA Devices		Price:	636,438.00
Product Category:	Digital		Cost:	455,396.00

Line #	Description
1-2	Defines the content for the <i>top</i> , two-line section of the sort heading. Each line contains three items: the first is a blank area (denoted by a space, separated from the next item by a <+0> spot marker); the second contains text; the third contains data values related to the text.
3-5	Defines the content for the <i>bottom</i> , three-line section of the sort heading. Each line contains five items: text; data values related to the text; a blank column (denoted by a space, separated from the next item by a null spot marker); text; data values related to the text.
6	Turns on internal cascading style sheets, a requirement for these formatting options. This command enables FOCUS StyleSheet attributes that were not previously available for HTML reports. This line of code is ignored for a PDF report.
7-11	<p>Specifies the basic formatting characteristics for the sort heading by breaking the content into five columns, each identified as an item with a defined width, and justification information for all but the empty column.</p> <p>Important: Had additional formatting code (annotated as 12-17) not been included in the request, the specifications annotated as 7-11 would have applied to the entire sort heading. That is, the formatting of the three columns in the top section of the heading would have been based on the specifications for the first three columns described below. However, that is not the desired effect, so a second section of StyleSheet code is defined to override this formatting for lines 1 and 2 of the sort heading. See annotations 12-18.</p> <p>The formatting of the <i>bottom</i>, three-line section of the heading is controlled by the following specifications:</p> <p>Item 1 identifies a columnar unit that contains text (that is, Product Number, Product Type, Product Category; it has a defined width of 1.25 inches and the text is right justified.</p> <p>Item 2 identifies a columnar unit that contains data values related to the text in item 1; it has a defined width of 1 inch and the data is right justified.</p>

Line #	Description
	<p>Item 3 identifies a columnar unit that contains blank space and serves as a separator between columns; it has a width of 1 inch. Justification is not relevant.</p> <p>Item 4 identifies a columnar unit that contains text (Quantity, Price, Cost); it has a defined width of 1 inch and the text is right justified.</p> <p>Item 5 identifies a columnar unit that contains a decimal value; the width of the column that contains the value is 1.5 inches, with the decimal point anchored .6 inches in from the right edge of that column.</p> <p>The common width and justification definitions enforce the proper alignment of each item.</p>
12	<p>Defines a variable called &INDENT, with a width setting of 1.5 inches. This variable defines the width of the blank area (item 1) at the beginning of lines 1 and 2 of the sort heading.</p> <p>Defining the width as a variable enables you to experiment with different widths simply by changing the value in one location. For a complex report, this technique can potentially save development time.</p>
13-18	<p>Specifies line-by-line formatting for the <i>top</i>, two-line section of the sort heading. This code overrides the previous formatting for lines 1 and 2 of the sort heading because it specifies a line number.</p> <p>Item 1 on each line refers to the blank area. The width is defined as a variable and implemented based on the current value of &INDENT.</p> <p>Item 2 on each line refers to the text area; it has a defined width of 1 inch and the text is left justified.</p> <p>Item 3 on each line refers to the data values; it has a defined width of 2 inches and the data is left justified.</p> <p>The common width and justification definitions enforce the proper alignment of each item.</p> <p>Notice that item 1 in line 15 defines a font size for the data values associated with the REGION field. All other items on both lines use a</p>

Line #	Description
	default font. Line-by-line formatting enables you to define a unique characteristic for a single item.

Support for Repeated Headings and Footings on Panels in PDF Report Output

When the columns presented on PDF reports cannot be displayed on a single page, the pages automatically panel. Paneling places subsequent columns for the same page on *overflow pages*. These overflow pages are generated until the entire width of the report is presented, after which the next vertical page is generated with a new page number and its associated horizontal panels.

In order to make panels following the initial panel more readable, you can designate that heading elements from the initial panel should be repeated on each subsequent panel using the HEADPANEL=ON StyleSheet attribute.

When paneling occurs, if default page numbering is used, the page number presented will include both the page number and the panel number (for example, 1.1, 1.2, 1.3). Turning HEADPANEL on will also cause the panel designation to be included in TABPAGENO.

HEADPANEL can be designated for the entire report, causing all headings and footings to be replicated on the paneled pages. It can also be turned on for just individual headings, footings, subheadings, or subfootings.

HEADPANEL causes borders from the initial page to be replicated on the paneled pages. Additional control of subheading and subfooting borders can be gained through the use of ALIGN-BORDERS which allows for the designation that subitem borders should align with the body of the data rather than the page or report headings. For more information about using ALIGN-BORDERS with HEADPANEL see [Align Subheading and Subfooting Margins With the Report Body](#).

Repeat Heading Elements on Panels

```
TYPE={REPORT|headfoot [BY=sortcolumn]}, HEADPANEL={ON|OFF}, $
```

where:

REPORT

Repeats all report headings, footings, page headings, page footings, subheadings, and subfootings.

headfoot

Identifies a heading or footing. Select from:

TABHEADING which is a report heading. This appears once at the beginning of the report and is generated by ON TABLE SUBHEAD.

TABFOOTING which is a report footing. This appears once at the end of the report and is generated by ON TABLE SUBFOOT.

HEADING which is a page heading. This appears at the top of every report page and is generated by HEADING.

FOOTING which is a page footing. This appears at the bottom of every report page and is generated by FOOTING.

SUBHEAD which is a sort heading. This appears at the beginning of a vertical (BY) sort group (generated by ON *sortfield* SUBHEAD).

SUBFOOT which is a sort footing. This appears at the end of a vertical (BY) sort group (generated by ON *sortfield* SUBFOOT).

BY

When there are several sort headings or sort footings, each associated with a different vertical sort (BY) column, this enables you to identify which sort heading or sort footing you wish to format.

If there are several sort headings or sort footings associated with different vertical sort (BY) columns, and you omit this attribute and value, the formatting will be applied to all of the sort headings or footings.

sortcolumn

Specifies the vertical sort (BY) column associated with one of the report sort headings or sort footings.

ON

Repeats the specified heading or footing elements on each panel.

OFF

Displays heading or footing elements on the first panel only. OFF is the default value.

Note that the HEADPANEL=ON attribute can only be applied to the entire heading or footing, not individual lines or items within the heading or footing.

Repeating All Headings and Footings on Report Panels

The following request against the GGSALES data source sums units sold, budgeted units sold, dollar sales, and budgeted sales by region, state, city, category, and product. The report has a page heading and, for each region, a subfooting:

```
TABLE FILE GGSALES
HEADING
"PRODUCT SALES REPORT"
""
"Page<TABPAGENO"
""
SUM UNITS BUDUNITS DOLLARS BUDDOLLARS
BY REGION NOPRINT
BY ST BY CATEGORY BY PRODUCT
ON REGION SUBFOOT
" "
" SUBFOOT FOR REGION <REGION "
" SUBTOTAL BUDDOLLARS: <ST.BUDDOLLARS SUBTOTAL DOLLARS: <ST.DOLLARS "
" "
ON TABLE SET BYPANEL ON
ON TABLE SET PAGE ON
ON TABLE HOLD FORMAT PDF
ON TABLE SET STYLE *
TYPE=REPORT, GRID=OFF, $
TYPE = REPORT, HEADPANEL=OFF,$
ENDSTYLE
END
```

The request sets BYPANEL ON, so each panel displays the sort field values. However, since HEADPANEL=OFF for the entire report, the first panel for page 1 has the heading and the subfooting, but the second panel does not.

The output for page 1 panel 1 has the heading and subfooting, as shown in the following image. Note that with HEADPANEL=OFF, TABPAGENO does not include the panel number:

PRODUCT SALES REPORT					
Page 1					
State	Category	Product	Unit Sales	Budget Units	Dollar Sales
IL	Coffee	Espresso	32237	32416	420439
		Latte	77344	79015	978340
	Food	Biscotti	29413	30001	378412
		Croissant	43300	43271	549366
		Scone	45355	45021	595069
	Gifts	Coffee Grinder	19339	19224	233292
		Coffee Pot	15785	16035	204528
		Mug	30357	30881	376754
		Thermos	34651	34337	387901
	MO	Coffee	Espresso	32596	32787
Latte			77347	77341	966981
Food		Biscotti	29188	28764	368077
		Croissant	48941	49327	613871
		Scone	37602	36573	481953
Gifts		Coffee Grinder	14634	14779	181570
		Coffee Pot	14807	14970	190152
		Mug	27040	26837	343852
		Thermos	35992	35903	395686
TX		Coffee	Espresso	36321	36666
	Latte		76922	77501	938245
	Food	Biscotti	27504	27074	345238
		Croissant	46941	47050	587587
		Scone	33170	32112	418398
	Gifts	Coffee Grinder	16440	16625	204292
		Coffee Pot	16564	16774	204897
		Mug	29521	29374	366337
		Thermos	36344	36779	394319
	SUBFOOT FOR REGION Midwest				
SUBTOTAL SUBDOLLARS: 11194173 SUBTOTAL DOLLARS: 11400665					
CT	Coffee	Capuccino	32386	31098	358995
		Espresso	22482	23676	279172
	Food	Latte	74623	74427	926052
		Biscotti	46234	46404	589155
		Croissant	45847	46335	581489
	Gifts	Scone	22378	21038	283874
		Coffee Grinder	13691	13117	169908
		Coffee Pot	15523	15190	208209
		Mug	31728	32415	392967
	MA	Coffee	Thermos	37568	37667
Capuccino			35358	35672	374344
Food		Espresso	39698	39888	248356
		Latte	74572	73874	917737
		Biscotti	47064	48246	570391
Gifts		Croissant	41029	41351	497234
		Scone	25363	23774	332486
		Coffee Grinder	34382	33384	377540

The output for page 1 panel 2 does not have the heading or subfooting, as shown in the following image.

<u>State</u>	<u>Category</u>	<u>Product</u>	<u>Budget Dollars</u>
IL	Coffee	Espresso	401477
		Latte	964787
	Food	Biscotti	385369
		Croissant	528255
		Scone	567231
	Gifts	Coffee Grinder	241711
		Coffee Pot	208255
		Mug	388612
		Thermos	181159
MO	Coffee	Espresso	416875
		Latte	921336
	Food	Biscotti	360403
		Croissant	592609
		Scone	478691
	Gifts	Coffee Grinder	171501
		Coffee Pot	191451
		Mug	324488
		Thermos	189484
TX	Coffee	Espresso	439880
		Latte	941677
	Food	Biscotti	321857
		Croissant	587869
		Scone	398437
	Gifts	Coffee Grinder	200241
		Coffee Pot	214301
		Mug	383050
		Thermos	193367
CT	Coffee	Capuccino	141574
		Espresso	299854
		Latte	953855
	Food	Biscotti	587501
		Croissant	580168
		Scone	269221
	Gifts	Coffee Grinder	159620
		Coffee Pot	197051
		Mug	424333
MA	Coffee	Thermos	219025
		Capuccino	192747
		Espresso	254310
	Food	Latte	941438
		Biscotti	616766
		Croissant	519322

The following output shows panels 1 and 2 if the StyleSheet declaration is changed to set HEADPANEL=ON for the entire report (TYPE=REPORT, HEADPANEL=ON , \$). The heading and subfooting are repeated on each panel. With HEADPANEL=ON, TABPAGENO includes the panel number:

PRODUCT SALES REPORT						
Page	1.1					
State	Category	Product	Unit Sales	Budget Units	Dollar Sales	
IL	Coffee	Espresso	12237	12414	420419	
		Latte	77244	79015	278140	
	Food	Biscotti	29413	30001	178412	
		Croissant	41300	42271	549166	
		Scone	45255	45091	595069	
	Gifts	Coffee Grinder	19229	19224	211292	
		Coffee Pot	15785	16035	204828	
		Mug	10157	10881	176754	
		Thermos	14651	14127	187901	
	MO	Coffee	Espresso	12596	12787	419143
			Latte	77247	77141	266981
Food		Biscotti	29188	28764	168077	
		Croissant	48941	49127	611871	
		Scone	17602	16571	481953	
Gifts		Coffee Grinder	14614	14779	181570	
		Coffee Pot	14807	14970	190153	
		Mug	27040	26817	341852	
		Thermos	15592	15903	195686	
TX		Coffee	Espresso	16221	16666	455165
			Latte	76922	77501	238245
	Food	Biscotti	27504	27074	145218	
		Croissant	46941	47050	587887	
		Scone	11170	12112	418198	
	Gifts	Coffee Grinder	16440	16625	204292	
		Coffee Pot	16564	16774	204897	
		Mug	29521	29174	366117	
		Thermos	16244	16779	194319	
	SUBFOOT FOR REGION Midwest					
	SUBTOTAL SUBDOLLARS: 11194173 SUBTOTAL DOLLARS: 11400665					
CT	Coffee	Capuccino	12286	11098	158995	
		Espresso	22482	21676	279173	
		Latte	74623	74427	226052	
	Food	Biscotti	46214	46404	589155	
		Croissant	45847	46125	551489	
		Scone	22278	21028	281874	
	Gifts	Coffee Grinder	13691	12117	169908	
		Coffee Pot	15523	15190	208209	
		Mug	11728	12415	192967	
		Thermos	17568	17667	221827	
	MA	Coffee	Capuccino	15258	15672	174344
Espresso			19698	19888	248156	
Latte			74572	72874	217717	
Food		Biscotti	47064	48246	570191	
		Croissant	41029	41151	497234	
		Scone	25263	22774	322486	
Gifts		Coffee Grinder	14282	15184	177940	

PRODUCT SALES REPORT			
Page	1.2		
State	Category	Product	Budget Dollars
IL	Coffee	Espresso	401477
		Latte	964787
	Food	Biscotti	185269
		Croissant	528255
		Scone	567231
	Gifts	Coffee Grinder	241711
		Coffee Pot	208255
		Mug	188612
		Thermos	181159
	MO	Coffee	Espresso
Latte			921216
Food		Biscotti	160401
		Croissant	592609
		Scone	478691
Gifts		Coffee Grinder	173501
		Coffee Pot	191451
		Mug	124488
		Thermos	189484
TX		Coffee	Espresso
	Latte		941677
	Food	Biscotti	121857
		Croissant	587869
		Scone	198417
	Gifts	Coffee Grinder	208241
		Coffee Pot	214201
		Mug	182050
		Thermos	192267
	SUBFOOT FOR REGION Midwest		
SUBTOTAL SUBDOLLARS: 11194373 SUBTOTAL DOLLARS: 11400665			
CT	Coffee	Capuccino	141574
		Espresso	299854
		Latte	952855
	Food	Biscotti	587501
		Croissant	580168
		Scone	269221
	Gifts	Coffee Grinder	159620
		Coffee Pot	197051
		Mug	424213
		Thermos	219025
MA	Coffee	Capuccino	192747
		Espresso	254210
		Latte	941418
	Food	Biscotti	616766
		Croissant	519222
		Scone	112004
	Gifts	Coffee Grinder	187686
		Coffee Pot	184071
		Mug	401617

Repeating a Subfoot on Panels in PDF Report Output

The following request against the GGSales data source specifies the HEADPANEL=ON attribute only for the subfoot, not for the entire report. Notice that this request uses the default page numbering (ON TABLE SET PAGE ON) rather than TABPAGE NO to present the page numbers on each page:

```
TABLE FILE GGSales
HEADING
" PRODUCT SALES REPORT"
```

```
" "  
SUM UNITS BUDUNITS DOLLARS BUDDOLLARS  
BY REGION NOPRINT  
BY ST BY CITY BY CATEGORY BY PRODUCT  
ON REGION SUBFOOT  
" "  
" SUBFOOT FOR REGION <REGION "  
" SUBTOTAL BUDDOLLARS: <ST.BUDDOLLARS SUBTOTAL DOLLARS: <ST.DOLLARS "  
" "  
ON TABLE SET BYPANEL ON  
ON TABLE SET PAGE ON  
ON TABLE HOLD FORMAT PDF  
ON TABLE SET STYLE *  
TYPE = SUBFOOT, HEADPANEL=ON,$  
ENDSTYLE  
END
```

Panel 1 displays both the heading and the subfooting, as shown in the following image:

PAGE 1.1		PRODUCT SALES REPORT				
State	City	Category	Product	Unit Sales		
IL	Chicago	Coffee	Espresso	32237		
			Latte	77344		
		Food	Biscotti	29413		
			Croissant	43300		
			Scone	45355		
		Gifts	Coffee Grinder	19339		
			Coffee Pot	15785		
			Mug	30157		
			Thermos	14651		
		MO	St. Louis	Coffee	Espresso	32596
					Latte	77347
Food	Biscotti			29188		
	Croissant			48941		
	Scone			37602		
Gifts	Coffee Grinder			14614		
	Coffee Pot			14807		
	Mug			27040		
	Thermos			15592		
TX	Houston			Coffee	Espresso	36321
					Latte	76932
		Food	Biscotti	27504		
			Croissant	46941		
			Scone	33170		
		Gifts	Coffee Grinder	16440		
			Coffee Pot	16564		
			Mug	29521		
			Thermos	16344		
		SUBFOOT FOR REGION Midwest				
		SUBTOTAL BUDDOLLARS: 11194373 SUBTOTAL DOLLARS: 11400665				
CT	New Haven	Coffee	Capuccino	12386		
			Espresso	22482		
			Latte	74623		
		Food	Biscotti	46214		
			Croissant	45947		
			Scone	22378		
		Gifts	Coffee Grinder	13691		
			Coffee Pot	15523		
			Mug	31728		
			Thermos	17568		

Panel 2 displays only the subfooting, not the heading, as shown in the following image.

PAGE		1.2		
State	City	Category	Product	Budget Units
IL	Chicago	Coffee	Espresso	32416
			Latte	79015
		Food	Biscotti	30001
			Croissant	43271
			Scone	45091
		Gifts	Coffee Grinder	19224
			Coffee Pot	16035
			Mug	30881
			Thermos	14137
MO	St. Louis	Coffee	Espresso	32787
			Latte	77141
		Food	Biscotti	28764
			Croissant	49327
			Scone	36973
		Gifts	Coffee Grinder	14779
			Coffee Pot	14970
			Mug	26837
			Thermos	15903
TX	Houston	Coffee	Espresso	36666
			Latte	77501
		Food	Biscotti	27074
			Croissant	47050
			Scone	32112
		Gifts	Coffee Grinder	16625
			Coffee Pot	16774
			Mug	29374
			Thermos	16779
SUBFOOT FOR REGION Midwest				
SUBTOTAL BUDDOLLARS: 11194373 SUBTOTAL DOLLARS: 11400665				
CT	New Haven	Coffee	Capuccino	11098
			Espresso	23676
		Food	Latte	74427
			Biscotti	46404
			Croissant	46335
		Gifts	Scone	21038
			Coffee Grinder	13117
			Coffee Pot	15190
			Mug	32415
			Thermos	17667

Since the page heading is not repeated, if you use the <TABPAGENO system variable to place the page number in the heading, it will not display the panel number and will not display on the second panel:

```
TABLE FILE GGSales
HEADING
" PRODUCT SALES REPORT PAGE <TABPAGENO"
" "
SUM UNITS BUDUNITS DOLLARS BUDDOLLARS
BY REGION NOPRINT
BY ST BY CITY BY CATEGORY BY PRODUCT
ON REGION SUBFOOT
" "
" SUBFOOT FOR REGION <REGION "
" SUBTOTAL BUDDOLLARS: <ST.BUDDOLLARS SUBTOTAL DOLLARS: <ST.DOLLARS "
```

```

" "
ON TABLE SET BYPANEL ON
ON TABLE PCHOLDHOLD FORMAT PDF
ON TABLE SET STYLE *
TYPE=REPORT, GRID=OFF, $
TYPE = SUBFOOT, HEADPANEL=ON,$
ENDSTYLE
END

```

The first panel displays the page number in the heading, without the panel number, as shown in the following image.

PRODUCT SALES REPORT PAGE 1				
<u>State</u>	<u>City</u>	<u>Category</u>	<u>Product</u>	<u>Unit Sales</u>
IL	Chicago	Coffee	Espresso	32237
			Latte	77344
		Food	Biscotti	29413
			Croissant	43300
			Scone	45355
		Gifts	Coffee Grinder	19339
			Coffee Pot	15785
			Mug	30157
			Thermos	14651
MO	St. Louis	Coffee	Espresso	32596
			Latte	77347
		Food	Biscotti	29188
			Croissant	48941
			Scone	37602
		Gifts	Coffee Grinder	14614
			Coffee Pot	14807
			Mug	27040
			Thermos	15592
TX	Houston	Coffee	Espresso	36321
			Latte	76932
		Food	Biscotti	27504
			Croissant	46941
			Scone	33170
		Gifts	Coffee Grinder	16440
			Coffee Pot	16564
			Mug	29521
			Thermos	16344
SUBFOOT FOR REGION Midwest				
SUBTOTAL BUDDOLLARS: 11194373 SUBTOTAL DOLLARS: 11400665				
CT	New Haven	Coffee	Capuccino	12386
			Espresso	22482
		Food	Latte	74623
			Biscotti	46214
			Croissant	45847
		Gifts	Scone	22378
			Coffee Grinder	13691
			Coffee Pot	15523
			Mug	31728
			Thermos	17568

The second panel does not display the heading and therefore, does not display the embedded page number, as shown in the following image:

<u>State</u>	<u>City</u>	<u>Category</u>	<u>Product</u>	<u>Budget</u>	<u>Units</u>
IL	Chicago	Coffee	Espresso	32416	
			Latte	79015	
		Food	Biscotti	30001	
			Croissant	43271	
			Scone	45091	
		Gifts	Coffee Grinder	19224	
			Coffee Pot	16035	
			Mug	30881	
			Thermos	14137	
MO	St. Louis	Coffee	Espresso	32787	
			Latte	77141	
		Food	Biscotti	28764	
			Croissant	49327	
			Scone	36573	
		Gifts	Coffee Grinder	14779	
			Coffee Pot	14970	
			Mug	26837	
			Thermos	15903	
TX	Houston	Coffee	Espresso	36666	
			Latte	77501	
		Food	Biscotti	27074	
			Croissant	47050	
			Scone	32112	
		Gifts	Coffee Grinder	16625	
			Coffee Pot	16774	
			Mug	29374	
			Thermos	16779	
SUBFOOT FOR REGION Midwest					
SUBTOTAL BUDDOLLARS: 11194373 SUBTOTAL DOLLARS: 11400665					
CT	New Haven	Coffee	Capuccino	11098	
			Espresso	23676	
		Food	Latte	74427	
			Biscotti	46404	
			Croissant	46335	
		Gifts	Scone	21038	
			Coffee Grinder	13117	
			Coffee Pot	15190	
			Mug	32415	
			Thermos	17667	

Repeating Styled Headings and Footings on Paneled Pages

The following request against the GGSales data source has a report heading, a page heading with an image, a footing, a subheading, a subfooting, and a subtotal:

```

SET BYPANEL=ON
DEFINE FILE GGSales
SHOWCATPROD/A30 = CATEGORY || ' / ' || PRODUCT;
END
TABLE FILE GGSales
SUM
    DOLLARS/I8M AS ''

```

```

BY REGION
BY ST
BY CITY
ACROSS SHOWCATPROD AS 'Product Sales'

```

```

ON REGION SUBHEAD
" "
"Subheading Region <REGION"
" "
ON REGION SUBTOTAL AS '*TOTAL'
ON REGION SUBFOOT WITHIN
" "

```

```

"Subfooting Region <REGION"
" "

```

```

ON TABLE SUBHEAD
"Report Heading"
HEADING
"Page <TABPAGENO "
" "
" "
" "

```

```

FOOTING
" "

```

```

"PAGE FOOTING "

```

```

ON TABLE SUBFOOT
" "

```

```

"Report Footing"

```

```

ON TABLE SET PAGE-NUM OFF

```

```

ON TABLE HOLD FORMAT PDF

```

```

ON TABLE SET HTMLCSS ON

```

```

ON TABLE SET STYLE *

```

```

    UNITS=IN,
    SQUEEZE=ON,
    ORIENTATION=PORTRAIT,

```

```

$

```

```

TYPE=REPORT,
    FONT='ARIAL',
    SIZE=9,
    HEADPANEL=ON,
    BORDER=ON,

```

```

$

```

```

TYPE=TITLE,
    STYLE=BOLD,

```

```

$

```

```

TYPE=TABHEADING,

```



```
        SIZE=20,  
        STYLE=BOLD,  
$  
TYPE=TABFOOTING,  
        SIZE=20,  
        STYLE=BOLD,  
$  
TYPE=HEADING,  
        SIZE=12,  
        STYLE=BOLD,  
$  
TYPE=HEADING,  
        LINE=1,  
        JUSTIFY=RIGHT,  
$  
TYPE=HEADING,  
        LINE=2,  
        JUSTIFY=RIGHT,  
$  
TYPE=HEADING,  
        LINE=3,  
        JUSTIFY=RIGHT,  
$  
TYPE=HEADING,  
        LINE=4,  
        JUSTIFY=RIGHT,  
$  
TYPE=HEADING,  
        LINE=5,  
        JUSTIFY=RIGHT,  
$  
TYPE=HEADING,  
        IMAGE=smplogo1.gif,  
        POSITION=(+0.000000 +0.000000),  
$  
TYPE=FOOTING,  
        SIZE=12,  
        STYLE=BOLD,  
        JUSTIFY=RIGHT,  
$  
TYPE=SUBHEAD,  
        SIZE=10,  
        STYLE=BOLD,  
$  
TYPE=SUBFOOT,  
        SIZE=10,  
        STYLE=BOLD,
```

```
$
TYPE=SUBTOTAL,
    BACKCOLOR=RGB(210 210 210),
$
TYPE=ACROSSVALUE,
    SIZE=9,
    WRAP=ON,
$
TYPE=ACROSSTITLE,
    STYLE=BOLD,
$
TYPE=GRANDTOTAL,
    BACKCOLOR=RGB(210 210 210),
    STYLE=BOLD,
$
ENDSTYLE
END
```

Since HEADPANEL=ON for the entire report, both panels display all of the heading and footing elements.

The following image shows page 1 panel 1.

Report Heading							
 The Standard for Enterprise Business Intelligence					Page 1.1		
			Product Sales				
			Coffee /Cappuccino	Coffee /Espresso	Coffee /Latte	Food /Biscotti	Food /Croissant
Region	State	City					
Subheading Region Midwest							
Midwest	IL	Chicago	-	\$420,439	\$976,340	\$378,412	\$549,386
	MO	St. Louis	-	\$419,143	\$998,981	\$369,077	\$613,871
	TX	Houston	-	\$495,365	\$938,245	\$345,236	\$587,857
*TOTAL Midwest			\$0	\$1,294,947	\$2,883,586	\$1,091,727	\$1,751,124
Subfooting Region Midwest							
Subheading Region Northeast							
Northeast	CT	New Haven	\$158,995	\$279,373	\$926,062	\$589,355	\$561,489
	MA	Boston	\$174,344	\$248,356	\$917,737	\$570,391	\$497,234
	NY	New York	\$208,756	\$322,378	\$926,026	\$642,259	\$622,095
*TOTAL Northeast			\$542,095	\$850,107	\$2,771,815	\$1,802,005	\$1,670,818
Subfooting Region Northeast							
Subheading Region Southeast							
Southeast	FL	Orlando	\$317,027	\$256,539	\$889,687	\$511,597	\$902,076
	GA	Atlanta	\$362,161	\$317,369	\$907,365	\$556,231	\$661,806
	TN	Memphis	\$274,812	\$279,844	\$820,584	\$438,889	\$638,477
*TOTAL Southeast			\$944,000	\$853,572	\$2,617,636	\$1,505,717	\$1,902,359
Subfooting Region Southeast							

The following image shows page 1 panel 2.

Report Heading							
					Page 1.2		
			Product Sales				
			Food /Scone	Gifts /Coffee Grinder	Gifts /Coffee Pot	Gifts /Mug	Gifts /Thermos
Region	State	City					
Subheading Region Midwest							
Midwest	IL	Chicago	\$595,069	\$233,292	\$204,828	\$376,754	\$187,801
	MO	St. Louis	\$461,953	\$181,570	\$190,153	\$343,852	\$195,898
	TX	Houston	\$418,358	\$204,292	\$204,897	\$386,337	\$194,319
*TOTAL Midwest			\$1,495,420	\$619,154	\$599,878	\$1,086,943	\$577,906
Subfooting Region Midwest							
Subheading Region Northeast							
Northeast	CT	New Haven	\$263,874	\$169,808	\$206,209	\$392,967	\$221,827
	MA	Boston	\$332,488	\$177,940	\$184,119	\$401,944	\$203,435
	NY	New York	\$290,811	\$161,352	\$186,462	\$349,300	\$178,836
*TOTAL Northeast			\$887,171	\$509,100	\$590,790	\$1,144,211	\$604,098
Subfooting Region Northeast							
Subheading Region Southeast							
Southeast	FL	Orlando	\$311,838	\$217,204	\$212,067	\$409,488	\$195,526
	GA	Atlanta	\$273,420	\$217,254	\$232,562	\$355,447	\$227,482
	TN	Memphis	\$315,359	\$171,319	\$200,894	\$337,790	\$209,449
*TOTAL Southeast			\$900,615	\$605,777	\$645,523	\$1,102,725	\$632,457
Subfooting Region Southeast							

Adding Grids and Borders

By default, an HTML report contains horizontal and vertical grid lines. You can remove the grid lines or adjust their use on a horizontal (BY) sort field. Grid characteristics apply to an entire HTML report, not to individual components of a report.

You can emphasize headings, footings, and column titles in a report by adding borders and grid lines around them.

Borders: In an HTML, PDF, EXL2K, or PS report, you can use BORDER attributes in a StyleSheet to specify the weight, style, and color of border lines. If you wish, you can specify formatting variations for the top, bottom, left, and right borders. BORDERS only work with the following syntax because they can only be implemented with internal cascading style sheets:

ON TABLE SET HTMLCSS ON

The BORDERALL StyleSheet attribute supports a heading or footing grid with borders around each individual heading or footing cell in PDF report output. Using this attribute along with BORDER attributes for individual objects in a heading or footing enables you to create borders around individual items.

Currently, with SQUEEZE=ON, the right margin border for subheadings and subfootings is defined based on the maximum width of all heading, footing, subheading, and subfooting lines. The length of subheading and subfooting lines is tied to the lengths of the page heading and page footing, not to the size of the data columns in the body of the report. You can use the ALIGN-BORDERS=BODY attribute in a StyleSheet to align the subheadings and subfootings with the report body on PDF report output instead of the other heading elements.

Grids: In an HTML report, you can use the GRID attribute in a StyleSheet to turn grid lines on and off for the entire report. When used in conjunction with internal Cascading StyleSheets, GRID produces a thin grid line rather than a thick double line (the HTML default). In PDF reports you can use the HGRID and VGRID attributes to add horizontal or vertical grid lines and adjust their density.

Note: The SET GRID parameter, which applies to graphs, is not the same as the GRID StyleSheet attribute.

Grid Display Attributes

Attribute	Description	Applies to
GRID	Controls grid display.	HTML
HGRID	Controls horizontal grid display and grid line density.	PDFPS
VGRID	Control vertical grid display and grid line density.	PDFPS

Control Grid Display in HTML Reports

```
[TYPE=REPORT,] GRID= option, $
```

where:

TYPE=REPORT

Applies the grid to the entire report. Not required, as it is the default.

option

Is one of the following:

ON applies a grid to a report. Does not apply grid lines to cells with a BY field value until the value changes. Column titles are not underlined. This value is the default.

OFF disables the default grid. Column titles are underlined. You can include blank lines and underlines. You cannot wrap cell data. With this setting, a report may be harder to read.

FILL applies grid lines to all cells of a report. Column titles are not underlined.

Add and Format Borders

To request a uniform border, use this syntax:

```
TYPE=type, BORDER=option, [BORDER-STYLE=line_style,]
[BORDER-COLOR={color|RGB(r g b)},] $
```

To specify different characteristics for the top, bottom, left, and/or right borders, use the syntax

```
TYPE=type, BORDER-position=option,
[BORDER[-position]-STYLE=line_style,]
[BORDER[-position]-COLOR={color|RGB(r g b)},] $
```

where:

type

Identifies the report component to which borders are applied.

option

Can be one of the following values:

ON turns borders on. ON generates the same line as MEDIUM.

i **Note:** The MEDIUM line setting ensures consistency with lines created with GRID attributes.

OFF turns borders off. OFF is the default value.

LIGHT specifies a thin line.

MEDIUM identifies a medium line. ON sets the line to MEDIUM.

HEAVY identifies a thick line.

width specifies the line width in points, where 72 pts=1 inch.

✓ **Tip:** Line width specified in points is displayed differently in HTML and PDF output. For uniform appearance, regardless of display format, use LIGHT, MEDIUM, or HEAVY.

position

Specifies which border line to format. Valid values are: TOP, BOTTOM, LEFT, RIGHT.

You can specify a position qualifier for any of the BORDER attributes. This enables you to format line width, line style, and line color individually, for any side of the border.

line_style

Sets the style of the border line. FOCUS StyleSheets support all of the standard cascading style sheet line styles. Several 3-dimensional styles are available only in HTML, as noted by asterisks. Valid values are:

Style	Description
NONE	No border is drawn.
SOLID	Solid line.
DOTTED	Dotted line.
DASHED	Dashed line.
DOUBLE	Double line.
GROOVE*	3D groove.
RIDGE*	3D ridge.
INSET*	3D inset.
OUTSET*	3D outset.

color

Is one of the preset color values. The default value is BLACK.

If the display or output device does not support colors, it substitutes shades of gray. For a complete list of available color values, see [Color Values in a Report](#).

RGB

Specifies the font color using a mixture of red, green, and blue.

(r g b)

Is the desired intensity of red, green, and blue, respectively. The values are on a scale of 0 to 255, where 0 is the least intense and 255 is the most intense. Using the three color components in equal intensities results in shades of gray.

Inserting and Formatting a Border

This request generates an HTML report with a heavy red dotted line around the entire report heading.

```
TABLE FILE GGSales
SUM BUdUNITS UNITS BUdDOLLARS DOLLARS
BY CATEGORY
ON TABLE SUBHEAD
"</1 Sales Report"
"***CONFIDENTIAL**"
"December 2002 </1"
ON TABLE SET PAGE-NUM OFF
ON TABLE HOLD FORMAT HTML
ON TABLE SET HTMLCSS ON
ON TABLE SET STYLESHEET *
TYPE=REPORT, GRID=OFF, $
TYPE=TABHEADING, STYLE=BOLD, JUSTIFY=Center, BORDER=HEAVY,
      BORDER-COLOR=RED, BORDER-STYLE=DOTTED, $
ENDSTYLE
END
```

The output is:

<p style="text-align: center;">Sales Report ***CONFIDENTIAL** December 2002</p>				
<u>Category</u>	<u>Budget Units</u>	<u>Unit Sales</u>	<u>Budget Dollars</u>	<u>Dollar Sales</u>
Coffee	1385923	1376266	17293886	17231455
Food	1377564	1384845	17267160	17229333
Gifts	931007	927880	11659732	11695502

✓ **Tip:** You can use the same BORDER syntax to generate this output in a PDF or PS report.

Applying Grid Lines to All Cells of an HTML Report

This request uses GRID=FILL to apply grid lines to all cells, including those underneath the sort field CATEGORY. With GRID=ON, the cells underneath the sort field value do not have grid lines until the sort field value changes.

```
TABLE FILE GGSales
SUM UNITS DOLLARS
BY CATEGORY BY PRODUCT
ON TABLE SET PAGE-NUM OFF
ON TABLE HOLD FORMAT HTML
ON TABLE SET STYLE *
TYPE=REPORT, GRID=FILL, $
ENDSTYLE
END
```

All cells have grid lines:

Category	Product	Unit Sales	Dollar Sales
Coffee	Capuccino	189217	2381590
	Espresso	308986	3906243
	Latte	878063	10943622
Food	Biscotti	421377	5263317
	Croissant	630054	7749902
	Scone	333414	4216114
Gifts	Coffee Grinder	186534	2337567
	Coffee Pot	190695	2449585
	Mug	360570	4522521
	Thermos	190081	2385829

Insert Inner and Outer Borders Within Headings or Footings in PDF Reports

BORDERALL is the quickest way to add borders to the entire heading grid. Individual borders can be removed by explicitly turning the border off in individual items using BORDER, BORDER-LEFT, BORDER-RIGHT, BORDER-TOP, and BORDER-BOTTOM. For a given item that is bordered by BORDERALL, BORDER-LEFT=OFF presents the item with no left border, but the defined border style is retained for top, bottom, and right borders.

Three levels of borders for headings and footings are supported:

1. Individual cell borders.

BORDER-LEFT, BORDER-RIGHT, BORDER-TOP, and BORDER-BOTTOM can be used to set the individual components of the external border of the heading or a selected item or cell.

2. All outer borders.

BORDER= is used to set the external borders within a heading or footing.

3. All outer and internal borders.

BORDERALL is used to apply border characteristics to both the internal and external borders of the selected heading or footing.



Note: BORDERALL applies to the entire heading or footing element. It cannot be used for individual lines or items within a heading or footing element.

To turn on all external and internal borders (a border grid):

```
TYPE=headfoot, BORDERALL=option, [BORDER-STYLE=line_style,] [BORDER-COLOR={color|RGB(rgb)},] $
```

where:

headfoot

Is the type of heading or footing. Valid values are TABHEADING, TABFOOTING, HEADING, FOOTING, SUBHEAD, and SUBFOOT.

i Note: BORDERALL applies to the entire heading or footing element. It cannot be used for individual lines or items within a heading or footing element.

To request a uniform border, use this syntax:

```
TYPE=headfoot, BORDER=option
```

To specify different characteristics for the top, bottom, left, and/or right borders, use this syntax:

```
TYPE=headfoot, BORDER-position=option,  
[BORDER[-position]-STYLE=line_style,]  
[BORDER[-position]-COLOR={color|RGB(rgb)},] $
```

where:

headfoot

Identifies the heading, footing, subheading, or subfooting to which borders are applied.

option

Can be one of the following values:

ON turns borders on. ON generates the same line as MEDIUM.

i Note: The MEDIUM line setting ensures consistency with lines created with GRID attributes.

OFF turns borders off. OFF is the default value.

LIGHT specifies a thin line.

MEDIUM identifies a medium line. ON sets the line to MEDIUM.

HEAVY identifies a thick line.

width specifies the line width in points, where 72 pts=1 inch. Note that this option is not supported with Excel 2003, which does not have an option for specifying a number to precisely set the border width (thickness) in points.

✔ **Tip:** Line width specified in points is displayed differently in HTML and PDF output. For uniform appearance, regardless of display format, use LIGHT, MEDIUM, or HEAVY.

position

Specifies which border line to format. Valid values are: TOP, BOTTOM, LEFT, RIGHT.

You can specify a position qualifier for any of the BORDER attributes. This enables you to format line width, line style, and line color individually, for any side of the border.

line_style

Sets the style of the border line. FOCUS StyleSheets support all of the standard cascading style sheet line styles. Several three-dimensional styles are available only in HTML, as noted by asterisks. Valid values are:

Style	Description
NONE	No border is drawn.
SOLID	Solid line.
DOTTED	Dotted line.
DASHED	Dashed line.
DOUBLE	Double line.
GROOVE*	3D groove. (Not supported with Excel 2003, which has no option for specifying this type of border.)

Style	Description
RIDGE*	3D ridge. (Not supported with Excel 2003, which has no option for specifying this type of border.)
INSET*	3D inset.
OUTSET*	3D outset.

color

Is one of the preset color values. The default value is BLACK.

If the display or output device does not support colors, it substitutes shades of gray. For a complete list of available color values, see the *Creating Reports* manual.

RGB

Specifies the font color using a mixture of red, green, and blue.

(rgb)

Is the desired intensity of red, green, and blue, respectively. The values are on a scale of 0 to 255, where 0 is the least intense and 255 is the most intense. Using the three color components in equal intensities results in shades of gray.

Controlling Borders Within Heading and Footing Elements in PDF Report Output

The following request against the EMPLOYEE data source has a page heading, a subheading, a subfooting, and a report footing:

```
TABLE FILE EMPLOYEE
HEADING
" Department Report Page <TABPAGENO >"
PRINT LAST_NAME AS ''
FIRST_NAME AS ''
```

```

CURR_SAL AS ''
CURR_JOBCODE AS ''
BY DEPARTMENT AS ''
WHERE CURR_SAL NE 0.0
ON TABLE HOLD FORMAT PDF
ON DEPARTMENT SUBFOOT
" "
"Subtotal:<ST.CURR_SAL"
" "
ON DEPARTMENT SUBHEAD
"Department <+0>Last Name <+0>First Name <+0>Salary<+0>Jobcode <+0>"
ON TABLE SUBFOOT
"Grand Total:<ST.CURR_SAL"
ON TABLE SET HTMLCSS ON
ON TABLE SET STYLE *
TYPE=REPORT, FONT=ARIAL, BORDER=ON, SQUEEZE=ON, $
TYPE=REPORT, COLUMN=CURR_JOBCODE,SQUEEZE=.75, $
TYPE = SUBHEAD, HEADALIGN=BODY, BORDERALL=ON,$
TYPE = SUBFOOT, HEADALIGN=BODY,$
TYPE = SUBFOOT, LINE=2, ITEM=1, COLSPAN=3, JUSTIFY=RIGHT,$
TYPE = SUBFOOT, LINE=2, ITEM=2, JUSTIFY=RIGHT,$
TYPE = TABFOOTING, HEADALIGN=BODY,$
TYPE = TABFOOTING, ITEM=1, COLSPAN=3, JUSTIFY=RIGHT,$
TYPE = TABFOOTING, ITEM=2, JUSTIFY=RIGHT,$
ENDSTYLE
END

```

The REPORT component has BORDER=ON, so the page heading has an external border.

The subheading has BORDERALL=ON and HEADALIGN=BODY, so the subheading grid aligns with the body grid, and each item within the subhead is presented as fully bordered individual cells.

The StyleSheet aligns the subfooting elements with the body of the report, and has the salary subtotal on the second line aligned and justified with the CURR_SAL column.

The table footing has a border around the entire footing because the REPORT component specifies BORDER=ON. The grand total is aligned and justified with the CURR_SAL column on the report.

The output is:

Department Report Page 1				
Department	Last Name	First Name	Salary	Jobcode
MIS	SMITH	MARY	\$13,200.00	B14
	JONES	DIANE	\$18,480.00	B03
	MCCOY	JOHN	\$18,480.00	B02
	BLACKWOOD	ROSEMARIE	\$21,780.00	B04
	GREENSPAN	MARY	\$9,000.00	A07
	CROSS	BARBARA	\$27,062.00	A17
Subtotal:			\$108,002.00	
Department	Last Name	First Name	Salary	Jobcode
PRODUCTION	STEVENS	ALFRED	\$11,000.00	A07
	SMITH	RICHARD	\$9,500.00	A01
	BANNING	JOHN	\$29,700.00	A17
	IRVING	JOAN	\$26,862.00	A15
	ROMANS	ANTHONY	\$21,120.00	B04
	MCKNIGHT	ROGER	\$16,100.00	B02
	Subtotal:			\$114,282.00
Grand Total:			\$222,284.00	

Align Subheading and Subfooting Margins With the Report Body

Currently, with SQUEEZE=ON, the right margin border for subheadings and subfootings is defined based on the maximum width of all heading, footing, subheading, and subfooting lines. The length of subheading and subfooting lines is tied to the lengths of the page heading and page footing, not to the size of the data columns in the body of the report.

You can use the ALIGN-BORDERS=BODY attribute in a StyleSheet to align the subheadings and subfootings with the report body on PDF report output instead of the other heading elements.

You can align subheading and subfooting margins with the report body either by adding the ALIGN-BORDERS=BODY attribute to the StyleSheet declaration for the REPORT component, or placing it in its own declaration without a TYPE attribute.

```
[TYPE=REPORT,] ALIGN-BORDERS={OFF|BODY} , $
```

where:

OFF

Does not align the right margin of subheadings and subfootings with the report body.

BODY

Specifies that the width of subheading and subfooting lines is independent of heading, footing, tabheading, and tabfooting lines, and that the right border of the report body will be aligned by either extending subheading and subfooting lines (if they are narrower than the data columns) or extending the data columns (if the data columns are narrower than the maximum width of subheadings and subfootings).

Considerations for Aligning Subheading and Subfooting Margins With the Report Body

Without the `ALIGN-BORDERS=BODY` attribute, the width of the subheading and subfooting lines is determined by the largest width of all of the headings and footings (report, page, subheadings, and subfootings).

The following image illustrates report output without the `ALIGN-BORDERS=BODY` attribute.

Report Heading					
TYPE=REPORT, ALIGN-BORDERS=OFF, BORDER=ON, \$					
Page Heading					
Product Sales					
			Coffee / Capuccino	Coffee / Espresso	Coffee / Latte
Region	State	City			
Subheading Region Midwest					
Midwest	IL	Chicago	-	\$420,439	\$978,340
	MO	St. Louis	-	\$419,143	\$968,981
	TX	Houston	-	\$455,365	\$938,245
*TOTAL Midwest			\$0	\$1,294,947	\$2,883,566
Subheading Region Northeast					
Northeast	CT	New Haven	\$158,995	\$279,373	\$928,052
	MA	Boston	\$174,344	\$248,356	\$917,737
	NY	New York	\$208,756	\$322,378	\$928,028
*TOTAL Northeast			\$542,095	\$850,107	\$2,771,815
Subheading Region Southeast					
Southeast	FL	Orlando	\$317,027	\$256,539	\$889,887
	GA	Atlanta	\$352,161	\$317,389	\$907,385
	TN	Memphis	\$274,812	\$279,644	\$820,584
*TOTAL Southeast			\$944,000	\$853,572	\$2,617,838
Subheading Region West					
West	CA	Los Angeles	\$306,468	\$267,809	\$809,647
		San Francisco	\$279,830	\$338,270	\$935,882
	WA	Seattle	\$309,197	\$301,538	\$924,896
*TOTAL West			\$895,495	\$907,617	\$2,670,405
TOTAL			\$2,381,590	\$3,906,243	\$10,943,622
Page Footing					Page 1
Report Footing					

When the body lines are wider than the subheading and subfooting lines, the border and bgcolor of the subheading and subfooting lines are expanded to match the width of the data lines, as shown on the following report output.

Report Heading					
TYPE=REPORT, ALIGN-BORDERS=BODY, BORDER=ON, \$					
Page Heading					
Product Sales					
		Coffee / Capuccino		Coffee / Espresso	Coffee / Latte
Region	State	City			
Subheading Region Midwest - Body is wider than Subheading					
Midwest	IL	Chicago	-	\$420,439	\$978,340
	MO	St. Louis	-	\$419,143	\$966,981
	TX	Houston	-	\$455,365	\$938,245
*TOTAL Midwest			\$0	\$1,294,947	\$2,883,566
Subheading Region Northeast - Body is wider than Subheading					
Northeast	CT	New Haven	\$158,995	\$279,373	\$926,052
	MA	Boston	\$174,344	\$248,356	\$917,737
	NY	New York	\$208,756	\$322,378	\$928,026
*TOTAL Northeast			\$542,095	\$850,107	\$2,771,815
Subheading Region Southeast - Body is wider than Subheading					
Southeast	FL	Orlando	\$317,027	\$256,539	\$889,887
	GA	Atlanta	\$352,161	\$317,389	\$907,365
	TN	Memphis	\$274,812	\$279,644	\$820,584
*TOTAL Southeast			\$944,000	\$853,572	\$2,617,836
Subheading Region West - Body is wider than Subheading					
West	CA	Los Angeles	\$306,468	\$267,809	\$809,647
		San Francisco	\$279,830	\$338,270	\$935,862
	WA	Seattle	\$309,197	\$301,538	\$924,896
*TOTAL West			\$895,495	\$907,617	\$2,670,405
TOTAL			\$2,381,590	\$3,906,243	\$10,943,622
Page Footing				Page 1	
Report Footing					

If the subheading and subfooting lines are longer than the body lines, an additional filler cell is added to each data line to allow the defined borders and bgcolor to fill the width defined by the subheading and subfooting lines, as shown on the following report output.

Report Heading						
TYPE=REPORT, ALIGN-BORDERS=BODY, BORDER=ON, \$						
Page Heading						
Product Sales						
Coffee / Capuccino Coffee / Espresso Coffee / Latte						
Region	State	City				
Subheading Region Midwest - This Subheading is wider than Body						
Midwest	IL	Chicago	.	\$420,439	\$978,340	
	MO	St. Louis	.	\$419,143	\$986,981	
	TX	Houston	.	\$455,365	\$938,245	
*TOTAL Midwest			\$0	\$1,294,947	\$2,883,566	
Subheading Region Northeast - This Subheading is wider than Body						
Northeast	CT	New Haven	\$158,995	\$279,373	\$926,052	
	MA	Boston	\$174,344	\$248,356	\$917,737	
	NY	New York	\$208,756	\$322,378	\$928,026	
*TOTAL Northeast			\$542,095	\$850,107	\$2,771,815	
Subheading Region Southeast - This Subheading is wider than Body						
Southeast	FL	Orlando	\$317,027	\$256,539	\$889,887	
	GA	Atlanta	\$352,161	\$317,389	\$907,365	
	TN	Memphis	\$274,812	\$279,644	\$820,584	
*TOTAL Southeast			\$944,000	\$853,572	\$2,617,836	
Subheading Region West - This Subheading is wider than Body						
West	CA	Los Angeles	\$306,468	\$267,909	\$809,647	
		San Francisco	\$279,830	\$338,270	\$935,862	
	WA	Seattle	\$309,197	\$301,538	\$924,896	
*TOTAL West			\$895,495	\$907,617	\$2,670,405	
TOTAL			\$2,381,590	\$3,906,243	\$10,943,622	
Page Footing						Page 1
Report Footing						

ALIGN-BORDERS=BODY has been designed to work on:

- Single panel reports (reports that do not panel horizontally).
- Paneled reports where HEADPANEL has been turned on for all of the subheadings and subfootings defined in the report.

Setting HEADPANEL ON causes the headings and footings from the first page of a paneled report to replicate on the subsequent panels. If HEADPANEL is not used, content can be placed in the paneled headings by explicitly positioning items within the headings using the StyleSheet attribute POSITION. In these situations, ALIGN-

BORDERS=BODY is ignored.

Therefore, if HEADPANEL is turned on at the REPORT level and not explicitly turned off for any of the individual subheadings or subfootings, or if it is explicitly turned on for all subheadings and subfootings, ALIGN-BORDERS=BODY will align the borders of all subheadings and subfootings to the data. Otherwise, the borders will continue to exhibit the default behavior of aligning with the page headings and footings.

Aligning Subheading and Subfooting Margins in a Single Panel PDF Report

The following request against the GGSALES data source has a report heading, report footing, page heading, page footing, and a subheading for each region. The margins of the subheadings and subfootings are not aligned (ALIGN-BORDERS=OFF , \$):

```

DEFINE FILE GGSALES
SHOWCATPROD/A30 = CATEGORY || (' / ' | PRODUCT);
END
TABLE FILE GGSALES
SUM
    DOLLARS/I8M AS ''
BY REGION
BY ST
BY CITY
ACROSS SHOWCATPROD AS 'Product Sales'

ON REGION SUBHEAD
" "
"Subheading <+0>Region <REGION<+0> "
" "
ON REGION SUBTOTAL AS '*TOTAL'
ON TABLE SUBHEAD
"Report Heading"
" "
"TYPE=REPORT, ALIGN-BORDERS=OFF, BORDER=ON, $"
HEADING
"Page Heading "
" "
" "
" "
FOOTING
" "
```

```
"Page Footing<+0>Page <TABPAGENO "
ON TABLE SUBFOOT
" "
"Report Footing"
```

```
WHERE CATEGORY EQ 'Coffee';
ON TABLE SET PAGE-NUM OFF
ON TABLE HOLD FORMAT PDF
ON TABLE SET HTMLCSS ON
ON TABLE SET STYLE *
    TYPE=REPORT,
    FONT='ARIAL',
    SIZE=9,
    LEFTMARGIN=.75,
    RIGHTMARGIN=.5,
    TOPMARGIN=.1,
    BOTTOMMARGIN=.1,
    ALIGN-BORDERS=OFF,
    BORDER=ON,
    SQUEEZE=ON,
$
TYPE=TITLE,
    STYLE=BOLD,
$
TYPE=TABHEADING,
    SIZE=12,
    STYLE=BOLD,
$
TYPE=TABHEADING,
    LINE=3,
    JUSTIFY=CENTER,
$
TYPE=TABFOOTING,
    SIZE=12,
    STYLE=BOLD,
$
TYPE=HEADING,
    SIZE=12,
    STYLE=BOLD,
$
TYPE=HEADING,
    IMAGE=smplogo1.gif,
    POSITION=(+4.60000000 +0.03000000),
    JUSTIFY=RIGHT,
$
TYPE=FOOTING,
```

```

        SIZE=12,
        STYLE=BOLD,
$
TYPE=FOOTING,
    LINE=2,
    ITEM=2,
    OBJECT=TEXT,
    POSITION=6.3,
    SIZE=12,
    STYLE=BOLD,
$
TYPE=SUBHEAD,
    SIZE=10,
    STYLE=BOLD,
$

```

```

TYPE=SUBHEAD,
    LINE=2,
    ITEM=3,
    OBJECT=TEXT,
    POSITION=2.5,
$
TYPE=SUBFOOT,
    SIZE=10,
    STYLE=BOLD,
$
TYPE=SUBTOTAL,
    BACKCOLOR=RGB(210 210 210),
$
TYPE=ACROSSVALUE,
    SIZE=9,
    WRAP=ON,
$
TYPE=ACROSSTITLE,
    STYLE=BOLD,
$
TYPE=GRANDTOTAL,
    BACKCOLOR=RGB(210 210 210),
    STYLE=BOLD,
$
ENDSTYLE
END

```

The output shows that the subheading margins align with the heading, not with the report body.

Report Heading					
TYPE=REPORT, ALIGN-BORDERS=OFF, BORDER=ON, \$					
Page Heading					
Product Sales					
Coffee / Coffee / Coffee / Capuccino Espresso Latte					
Region	State	City			
Subheading Region Midwest					
Midwest	IL	Chicago	.	\$420,439	\$978,340
	MO	St. Louis	.	\$419,143	\$966,981
	TX	Houston	.	\$455,365	\$938,245
*TOTAL Midwest			\$0	\$1,294,947	\$2,883,568
Subheading Region Northeast					
Northeast	CT	New Haven	\$158,995	\$279,373	\$926,052
	MA	Boston	\$174,344	\$248,356	\$917,737
	NY	New York	\$208,756	\$322,378	\$928,028
*TOTAL Northeast			\$542,095	\$850,107	\$2,771,815
Subheading Region Southeast					
Southeast	FL	Orlando	\$317,027	\$256,539	\$889,887
	GA	Atlanta	\$352,161	\$317,389	\$907,365
	TN	Memphis	\$274,812	\$279,644	\$820,584
*TOTAL Southeast			\$944,000	\$853,572	\$2,617,836
Subheading Region West					
West	CA	Los Angeles	\$306,468	\$267,809	\$909,647
		San Francisco	\$279,830	\$338,270	\$935,862
	WA	Seattle	\$309,197	\$301,538	\$924,898
*TOTAL West			\$895,495	\$907,617	\$2,670,405
TOTAL			\$2,381,590	\$3,906,243	\$10,943,622
Page Footing					Page 1
Report Footing					

Now change the ALIGN-BORDERS attribute to ALIGN-BORDERS=BODY and rerun the request. The subheadings now align with the report body, as shown in the following image.

Report Heading					
TYPE=REPORT, ALIGN-BORDERS=BODY, BORDER=ON, \$					
Page Heading			Information Builders <small>The Standard for Enterprise Business Intelligence</small>		
			Product Sales Coffee / Capsules Coffee / Espresso Coffee / Latte		
Region	State	City			
Subheading Region Midwest					
Midwest	IL	Chicago	.	\$120,000	\$170,000
	MO	St. Louis	.	\$170,000	\$250,000
	TX	Houston	.	\$150,000	\$220,000
TOTAL Midwest			\$3	\$1,290,000	\$1,890,000
Subheading Region Northeast					
Northeast	CT	New Haven	\$150,000	\$220,000	\$300,000
	MA	Boston	\$200,000	\$280,000	\$380,000
	NY	New York	\$250,000	\$350,000	\$480,000
TOTAL Northeast			\$600,000	\$850,000	\$1,160,000
Subheading Region Southeast					
Southeast	FL	Orlando	\$110,000	\$160,000	\$220,000
	GA	Atlanta	\$120,000	\$170,000	\$230,000
	TN	Memphis	\$120,000	\$170,000	\$230,000
TOTAL Southeast			\$350,000	\$500,000	\$680,000
Subheading Region West					
West	CA	Los Angeles	\$200,000	\$280,000	\$380,000
		San Francisco	\$250,000	\$350,000	\$480,000
	WA	Seattle	\$300,000	\$420,000	\$580,000
TOTAL West			\$750,000	\$1,050,000	\$1,440,000
TOTAL			\$3,000,000	\$4,200,000	\$5,800,000
Page Footing					Page 1
Report Footing					

Aligning Subheading and Subfooting Margins in a Multi-Panel Report

The following request has HEADPANEL=ON for all headings and footings. It also has the ALIGN-BORDERS=BODY attribute:

```
SET BYPANEL=ON
DEFINE FILE GGSales
```

```

SHOWCATPROD/A30 = CATEGORY || (' / ' | PRODUCT);
END
TABLE FILE GGSALES
SUM
    DOLLARS/I8M AS ''
BY REGION
BY ST
BY CITY
ACROSS SHOWCATPROD AS 'Product Sales'

ON REGION SUBHEAD
" "
"Subheading <+0>Region <REGION<+0> "
" "
ON REGION SUBTOTAL AS '*TOTAL'
ON TABLE SUBHEAD
"Report Heading"
" "
"TYPE=REPORT, ALIGN=BORDERS=BODY, HEADPANEL=ON, BORDER=ON, $"
HEADING
"Page Heading "
" "
" "
" "
FOOTING
" "
"Page Footing<+0>Page <TABPAGENO "
ON TABLE SUBFOOT
" "
"Report Footing"

```

```

WHERE CATEGORY NE 'Coffee';
ON TABLE SET PAGE-NUM OFF
ON TABLE HOLD FORMAT PDF
ON TABLE SET HTMLCSS ON
ON TABLE SET STYLE *
    UNITS=IN,
    SQUEEZE=ON,
    ORIENTATION=PORTRAIT,
$
TYPE=REPORT,
    FONT='ARIAL',
    SIZE=9,
    LEFTMARGIN=.75,
    RIGHTMARGIN=.5,
    TOPMARGIN=.1,

```

```
BOTTOMMARGIN= .1,  
HEADPANEL=ON,  
ALIGN-BORDERS=BODY,  
BORDER=ON,  
$  
TYPE=TITLE,  
    STYLE=BOLD,  
$  
TYPE=TABHEADING,  
    SIZE=12,  
    STYLE=BOLD,  
$  
TYPE=TABHEADING,  
    LINE=3,  
    JUSTIFY=CENTER,  
$  
TYPE=TABFOOTING,  
    SIZE=12,  
    STYLE=BOLD,  
$  
TYPE=HEADING,  
    SIZE=12,  
    STYLE=BOLD,  
$  
TYPE=HEADING,  
    IMAGE=smplogo1.gif,  
    POSITION=(+4.60000000 +0.03000000),  
    JUSTIFY=RIGHT,  
$  
TYPE=FOOTING,  
    SIZE=12,  
    STYLE=BOLD,  
$  
TYPE=FOOTING,  
    LINE=2,  
    ITEM=2,  
    OBJECT=TEXT,  
    POSITION=6.3,  
    SIZE=12,  
    STYLE=BOLD,  
$
```

```
TYPE=SUBHEAD,  
    SIZE=10,  
    STYLE=BOLD,  
$
```

```

TYPE=SUBHEAD,
  LINE=2,
  ITEM=3,
  OBJECT=TEXT,
  POSITION=2.5,
$
TYPE=SUBFOOT,
  SIZE=10,
  STYLE=BOLD,
$
TYPE=SUBTOTAL,
  BACKCOLOR=RGB(210 210 210),
$
TYPE=ACROSSVALUE,
  SIZE=9,
  WRAP=ON,
$
TYPE=ACROSSTITLE,
  STYLE=BOLD,
$
TYPE=GRANDTOTAL,
  BACKCOLOR=RGB(210 210 210),
  STYLE=BOLD,
$
ENDSTYLE
END
    
```

The output shows that the subheadings are aligned with the data on each panel.

Report Heading		TYPE=REPORT, ALIGN=BORDERS=BODY, HEADPANEL=ON, BORDER=ON, \$					
Page Heading							
		Product Sales					
Region	State	City	Food / Biscotti	Food / Croissant	Food / Scone	Gifts / Coffee Grinder	Gifts / Coffee Pot
Subheading Region Midwest							
Midwest	IL	Chicago	\$378,412	\$649,366	\$896,069	\$233,292	\$204,628
	MO	St. Louis	\$369,077	\$613,871	\$481,953	\$181,570	\$190,163
	TX	Houston	\$346,238	\$607,687	\$418,399	\$206,292	\$204,897
*TOTAL Midwest			\$1,091,727	\$1,761,124	\$1,496,420	\$619,154	\$699,678
Subheading Region Northeast							
Northeast	CT	New Haven	\$689,356	\$651,489	\$283,874	\$169,958	\$209,209
	MA	Boston	\$570,391	\$497,234	\$332,489	\$177,940	\$194,119
	NY	New York	\$642,339	\$623,096	\$300,911	\$196,362	\$198,462
*TOTAL Northeast			\$1,862,086	\$1,670,818	\$897,171	\$558,200	\$602,790
Subheading Region Southeast							
Southeast	FL	Orlando	\$511,597	\$602,076	\$311,836	\$217,204	\$212,067
	GA	Atlanta	\$666,221	\$661,808	\$373,320	\$217,204	\$232,852
	TN	Memphis	\$438,680	\$638,477	\$316,399	\$171,318	\$200,634
*TOTAL Southeast			\$1,606,717	\$1,902,361	\$900,665	\$605,777	\$645,353
Subheading Region West							
West	CA	Los Angeles	\$266,030	\$600,084	\$318,694	\$214,857	\$202,285
	CA	San Francisco	\$269,618	\$624,457	\$342,939	\$187,123	\$197,844
	WA	Seattle	\$328,320	\$601,060	\$304,445	\$201,766	\$213,494
*TOTAL West			\$863,888	\$2,425,601	\$912,868	\$603,436	\$613,624
TOTAL			\$4,266,817	\$7,749,960	\$4,216,114	\$2,837,667	\$2,449,666
Page Footing		Page 1.1					
Report Footing							

Report Heading		TYPE=REPORT, ALIGN=BORDERS=BODY, HEADPANEL=ON, BORDER=ON, \$		
Page Heading				
		Product Sales		
Region	State	City	Gifts / Mug	Gifts / Thermos
Subheading Region Midwest				
Midwest	IL	Chicago	\$376,764	\$187,801
	MO	St. Louis	\$343,852	\$195,686
	TX	Houston	\$366,337	\$194,219
*TOTAL Midwest			\$1,086,943	\$677,806
Subheading Region Northeast				
Northeast	CT	New Haven	\$392,967	\$221,827
	MA	Boston	\$402,344	\$202,435
	NY	New York	\$345,300	\$178,836
*TOTAL Northeast			\$1,140,211	\$603,098
Subheading Region Southeast				
Southeast	FL	Orlando	\$409,466	\$195,826
	GA	Atlanta	\$366,447	\$227,462
	TN	Memphis	\$337,790	\$209,449
*TOTAL Southeast			\$1,102,703	\$632,487
Subheading Region West				
West	CA	Los Angeles	\$381,326	\$207,613
	CA	San Francisco	\$373,399	\$164,116
	WA	Seattle	\$427,339	\$198,640
*TOTAL West			\$1,182,064	\$570,369
TOTAL			\$4,652,621	\$2,686,828
Page Footing		Page 1.2		
Report Footing				

Add and Adjust Grid Lines (PDF or PS)

This syntax applies to a PDF or PS report.

```
TYPE=type, {HGRID|VGRID}={ON|OFF|HEAVY}, $
```

where:

type

Identifies the report component to which grid lines are applied.

HGRID

Specifies horizontal grid lines.

VGRID

Specifies vertical grid lines.

ON

Applies light grid lines.

OFF

Suppresses grid lines. This is the default.

HEAVY

Applies heavy grid lines.

Applying Grid Lines to Report Data (PDF)

This request applies light, horizontal grid lines to report data.

```
TABLE FILE GGDEMOG
HEADING
"State Statistics"
" "
SUM HH AS 'Number of,Households' AVGHHSZ98 AS 'Avg.,Size'
MEDHHI98 AS 'Avg.,Income'
BY ST
```

```

WHERE ST EQ 'CA' OR 'FL' OR 'NY'
ON TABLE SET PAGE-NUM OFF
ON TABLE HOLD FORMAT PDF
ON TABLE SET STYLE *
TYPE=DATA, HGRID=ON, $
ENDSTYLE
END

```

In the PDF report, the lines make it easier to distinguish the data by state:

State Statistics			
State	Number of Households	Avg. Size	Avg. Income
CA	11478067	3	44925
FL	5968392	2	34264
NY	6799434	3	42023

Displaying Superscripts On Data, Heading, and Footing Lines

Superscript characters are supported as a text style in text objects using HTML markup tags. The superscript markup tag is also supported in data columns, headings, and footings in HTML, PDF, and PS output formats. Superscript values can be defined within the data, added to virtual fields, or added to text strings displayed in headings and footings.

In order to activate the translation of the HTML markup tags, in the StyleSheet set `MARKUP=ON` for any report component that will display superscripts. Without this attribute, the markup tags will be treated as text, not tags.

Display Superscripts on Report Data, Heading, and Footing Lines

If the tags are not within the data itself, create a field that contains the text to be used as a superscript. Also, turn markup tags on for the components that will display superscripts:

- In a DEFINE or COMPUTE command, define a field that contains the text to be displayed as a superscript.

For a DEFINE FILE command, the syntax is:

```
DEFINE FILE ...
field/An = <sup>text</sup>;
END
```

For a COMPUTE command or a DEFINE in a Master File, the syntax is:

```
{COMPUTE|DEFINE} field/An = <sup>text</sup>;
```

where:

n

Is the length of the string defining the superscript, including the text to be used as the superscript and the opening and closing markup tags (^{and}).

text

Is the text to be used as the superscript.

- In the StyleSheet, set MARKUP=ON for any report component that will display superscripts:

```
TYPE=component,MARKUP=ON ... , $
```

where:

component

Is one of the following report components: DATA, HEADING, FOOTING, SUBHEAD, SUBFOOT, TABHEADING, TABFOOTING.

Displaying Superscripts in Data and Footing Lines in PDF Output

The following request against the GGSALES data source defines two fields that will display as superscripts. SUP1 and SUP2 consist of the numbers 1 and 2, respectively. SUPSTAR consists of an asterisk symbol. Note that the difference is the syntax as defined for a text value as opposed to a HEX value.

The COMPUTE command compares sales dollars to budgeted dollars. If the value calculated is less than a minimum defined, the superscript SUP1 is concatenated after the category name. If the value is greater, SUP2 is concatenated.

The superscript SUPSTAR is used to display an asterisk in the report heading and a corresponding footnote in the report footing.

The footing concatenates the superscript fields in front of their explanations.

In the StyleSheet, every component that will display a superscript has the attribute MARKUP=ON.

```

DEFINE FILE GGSALES
SUP1/A12= '<SUP>1</SUP>';
SUP2/A15= '<SUP>2</SUP>';
SUPSTAR/A20= '<SUP>' || HEXBYT(92, 'A2') || '</SUP>';
END
TABLE FILE GGSALES
SUM
COMPUTE PROFIT/D12CM=DOLLARS-BUDDOLLARS; NOPRINT
COMPUTE SHOWCAT/A100=IF PROFIT LE -50000 THEN CATEGORY || SUP1
        ELSE IF PROFIT GT 50000 THEN CATEGORY || SUP2
        ELSE CATEGORY; AS Category
BUDDOLLARS/D12CM
DOLLARS/D12CM
BY REGION
BY CATEGORY NOPRINT
HEADING
"Analysis of Budgeted and Actual Sales <SUPSTAR"
FOOTING
""
"<SUP1 Dollar sales $50,000 less than budgeted amount."
"<SUP2 Dollar sales $50,000 greater than budgeted amount."
""

```



```
"<SUPSTAR by Information Builders, Inc "
ON TABLE SET HTMLCSS ON
ON TABLE SET SQUEEZE ON
ON TABLE SET PAGE-NUM OFF
ON TABLE HOLD FORMAT PDF
ON TABLE SET STYLE *
TYPE=REPORT, FONT=HELVETICA,$
TYPE=DATA,MARKUP=ON,$
TYPE=DATA,COLUMN=N5, COLOR=RED, WHEN=PROFIT LT -50000,$
TYPE=DATA,COLUMN=N6, COLOR=GREEN, WHEN=PROFIT GT 50000,$
TYPE=HEADING, JUSTIFY=LEFT,MARKUP=ON,$
TYPE=FOOTING, MARKUP=ON, JUSTIFY=LEFT,$
TYPE=FOOTING, LINE=2,JUSTIFY=LEFT, COLOR=RED,$
TYPE=FOOTING, LINE=3,JUSTIFY=LEFT, COLOR=GREEN,$
ENDSTYLE
END
```

The output is:

Analysis of Budgeted and Actual Sales *			
Region	Category	Budget Dollars	Dollar Sales
Midwest	Coffee ²	\$4,086,032	\$4,178,513
	Food ²	\$4,288,499	\$4,404,483
	Gifts	\$2,935,656	\$2,931,349
Northeast	Coffee ¹	\$4,294,419	\$4,201,057
	Food ¹	\$4,501,153	\$4,445,197
	Gifts	\$2,870,552	\$2,848,289
Southeast	Coffee	\$4,451,394	\$4,435,134
	Food ¹	\$4,409,288	\$4,308,731
	Gifts	\$3,008,272	\$3,037,420
West	Coffee ¹	\$4,545,908	\$4,493,483
	Food	\$4,187,417	\$4,204,333
	Gifts	\$2,934,306	\$2,977,092

¹ Dollar sales \$50,000 less than budgeted amount.
² Dollar sales \$50,000 greater than budgeted amount.

* by Information Builders, Inc

Adding an Image to a Report

With a StyleSheet you can add and position an image in a report. An image, such as a logo, gives corporate identity to a report, or provides visual appeal. You can add more than one image by creating multiple declarations.

You can also add an image as a background to a report. A background image is tiled or repeated, covering the entire area on which the report appears. An image attached to an entire report, or an image in a heading or footing, can appear with a background image.

Images must exist in a file format your browser supports, such as GIF (Graphic Interchange Format) or JPEG (Joint Photographic Experts Group).

Image support with FOCUS standard reporting formats

- GIF and JPG images are supported in DHTML, HTML, PDF, PS, PPTX, XLSX, and PPT standard report formats. JPEG image types are only supported with the HTML standard report format. For other report formats, you can change the extension of the image name from .jpeg to .jpg, and the image will be displayed in the report output.
- PNG image types are supported with DHTML, HTML, and PPTX standard report formats. The SVG image type is supported only with HTML reports. Images are not supported in the EXL2K standard report format.

Image support in Compound Report syntax

- GIF and JPG images are supported in DHTML, PDF, PPTX, and PPT Compound document syntax. JPEG images are not supported with any reporting format, but the images will work in these compound formats if the extension is changed from .jpeg to .jpg.
- PNG image types are supported with DHTML, PPT, and PPTX Compound documents. SVG image types are not supported with any FOCUS reporting format in Compound documents, while FOCUS generated SVG charts are supported only with PDF Compound documents. Images are not supported in EXL2K Compound documents.

-

i Note: Images in report components in Compound documents are supported as described under *Image support with WebFOCUS standard reporting formats*. This section, *Image support in Compound report syntax*, refers to images inserted in the PAGELAYOUT sections of the Compound syntax.

For PDF, HTML, and DHTML output against data sources that support the Binary Large Object (BLOB) data type (Microsoft SQL Server, DB2, Oracle, Informix, and PostgreSQL, using its BYTEA data type), an image can be stored in a BLOB field in the data source.

In an HTML report, the Web browser locates and displays the image, so it must be in a location that the browser can find. If the file is not on the search path, supply the full path name.

In a PDF or PS report, FOCUS reads the image and places it in the PDF or PS output file. Thus, the GIF or JPEG file must reside in a sequential file or be a member of a data set allocated to any DDNAME (such as GIF or JPG) on z/OS. You can then use the DDNAME or the file name as the image name in the StyleSheet declaration. The LRECL for the image data set is 1024. For example:

```
LRECL=1024, BLKSIZE=30720, RECFM=FB, DSORG=PO
```

i Note: For JPEG files, currently only the .jpg extension is supported. The .jpeg extension is not supported.

Image Attributes

Attribute	Description
IMAGE	Adds an image.
IMAGEALIGN	Positions an image. This applies only to HTML reports.
POSITION	Positions an image.
IMAGEBREAK	Controls the generation of a line break after an image. This applies only to HTML reports without internal cascading style sheets.

Attribute	Description
SIZE	Sizes an image.
ALT	Supplies a description of an image for compliance with Section accessibility (Workforce Investment Act of 1998). ALT only applies to HTML reports.
BACKIMAGE	Adds a background image.

Add an Image to an HTML Report

This syntax applies to an HTML report. For details on adding an image to a PDF, PS, or an HTML report with internal CSS, see [Add an Image to an HTML Report](#).

```
TYPE={REPORT|heading}, IMAGE={url|(column)} [,IMAGEALIGN=position]
[,IMAGEBREAK={ON|OFF}] [,ALT='description'], $
```

where:

REPORT

Embeds an image in the body of a report. This value is the default. **Note:** The IMAGE=(column) option is not supported with TYPE=REPORT.

heading

Embeds an image in a heading or footing. Valid values are TABHEADING, TABFOOTING, HEADING, FOOTING SUBHEAD, and SUBFOOT.

url

Is the URL for the image file. The image must exist in a separate file in a format that your browser supports, such as GIF or JPEG. The file can be on your local Web server, or on any server or directory accessible from your network. For details, see [Specifying a URL](#).

column

Is an alphanumeric field in a request (for example, a display field or a BY field) whose value is a URL that points to an image file. Specify a value using the COLUMN attribute described in [Identifying Report Components](#). Enclose *column* in parentheses.

This option enables you to add different images to a heading or footing, depending on the value of the field.

position

Is the position of the image. Valid values are:

TOP where the top-right corner of the image aligns with heading or footing text. If the image is attached to the entire report, it appears on top of the report.

MIDDLE where the image appears in the middle of the heading or footing text. If the image is attached to the entire report, it appears in the middle of the report.

BOTTOM where the bottom right corner of the image aligns with heading or footing text. If the image is attached to the entire report, it appears at the bottom of the report.

LEFT where the image appears to the left of heading or footing text. If the image is attached to the entire report, it appears to the left of the report.

RIGHT where the image appears to the right of heading or footing text. If the image is attached to the entire report, it appears to the right of the report.

IMAGEBREAK

Controls the generation of a line break after the image. Valid values are:

ON which generates a line break after the image so that an element following it (such as report heading text) appears on the next line.

OFF which suppresses a line break after the image so that an element following it is on the same line. This value is the default.

description

Is a textual description of an image for compliance with Section 508 accessibility. Enclose the description in single quotation marks.

Specifying a URL

The following guidelines are the same for `IMAGE=url` and `IMAGE=(column)` syntax. In the latter case, they apply to a URL stored in a data source field.

Specify a URL by:

- Supplying an absolute or relative address that points to an image file, for example:

```
TYPE=TABHEADING,IMAGE=http://www.ibi.com/images/logo_wf3.gif,$
TYPE=TABHEADING, IMAGE=/ibi_html/ggdemo/gotham.gif,$
```

- Using the `SET BASEURL` parameter to establish a URL that is logically prefixed to all relative URLs in the request. With this feature, you can add an image by specifying just its file name in the `IMAGE` attribute. For example:

```
SET BASEURL=D:\ibi\apps\SESSION\
.
.
.
TYPE=REPORT, IMAGE=gotham.gif,$
```

The following conditions apply:

- A base URL must end with a slash (/) or backslash (\).
- An absolute URL (which begins with `http://`) overrides a base URL.
- A URL is case-sensitive when referring to a UNIX server.
- If the name of the image file does not contain an extension, GIF is used.

Adding an Image to an HTML Report Heading

This request adds the Gotham Grinds logo to a report heading. The logo is in a separate image file identified by a relative URL in the `IMAGE` attribute.

```
TABLE FILE GGORDER
ON TABLE SUBHEAD
"PRODUCTS ORDERED ON 08/01/96"
SUM QUANTITY AS 'Ordered Units' BY PRODUCT
```

```

WHERE PRODUCT EQ 'Coffee Grinder' OR 'Coffee Pot'
WHERE ORDER_DATE EQ '08/01/96'
ON TABLE SET PAGE-NUM OFF
ON TABLE HOLD FORMAT HTML
ON TABLE SET STYLE *
TYPE=TABHEADING, IMAGE=C:\IMAGES\GOTHAM.GIF, IMAGEBREAK=ON, $
ENDSTYLE
END

```

IMAGEBREAK, set to ON, generates a line break between the logo and the heading text:



PRODUCTS ORDERED ON 08/01/96

Product	Ordered Units
Coffee Grinder	2493
Coffee Pot	3100

Using a File Name in a Data Source Field in an HTML Report

The following illustrates how to embed an image in a SUBHEAD, and use a different image for each value of the BY field on which the SUBHEAD occurs.

```
SET BASEURL=c:\images\
```

```
DEFINE FILE CAR
FLAG/A12=
```

```

DECODE COUNTRY ( 'ENGLAND' 'uk' 'ITALY' 'italy'
  'FRANCE' 'france' 'JAPAN' 'japan' );
END

```

```

TABLE FILE CAR
PRINT FLAG NOPRINT AND MODEL AS '' BY COUNTRY NOPRINT AS '' BY CAR AS ''
WHERE COUNTRY EQ 'ENGLAND' OR 'FRANCE' OR 'ITALY' OR 'JAPAN'
ON COUNTRY SUBHEAD
"                               <+0>Cars produced in <ST.COUNTRY"
HEADING CENTER
"Car Manufacturer Report"
" "
ON TABLE SET PAGE-NUM OFF
ON TABLE HOLD FORMAT HTML
ON TABLE SET STYLE *
TYPE=SUBHEAD, IMAGE=(FLAG), IMAGEALIGN=TOP, $
TYPE=REPORT, GRID=OFF, $
TYPE=HEADING, SIZE=12, STYLE=BOLD, $
TYPE=SUBHEAD, STYLE=BOLD, $
ENDSTYLE
END

```

The output is:

Car Manufacturer Report	
	Cars produced in ENGLAND
JAGUAR	V12XKE AUTO XJ12L AUTO
JENSEN	INTERCEPTOR III
TRIUMPH	TR7
	Cars produced in FRANCE
PEUGEOT	504 4 DOOR
	Cars produced in ITALY
ALFA ROMEO	2000 4 DOOR BERLINA 2000 GT VELOCE 2000 SPIDER VELOCE
MASERATI	DIORA 2 DOOR
	Cars produced in JAPAN
DATSUN	B210 2 DOOR AUTO
TOYOTA	COROLLA 4 DOOR DEK AUTO

Supplying an Image Description Using the ALT Attribute

The following illustrates how to use the ALT attribute. The ALT attribute supplies a description of an image that screen readers can interpret to comply with Section 508 accessibility (Workforce Investment Act of 1998).

```
SET BASEURL=C:\images\  
TABLE FILE GGSales  
SUM UNITS BY PRODUCT  
ON TABLE SUBHEAD  
"Report on Units Sold"  
ON TABLE SET PAGE-NUM OFF  
ON TABLE HOLD FORMAT HTML  
ON TABLE SET STYLE *  
TYPE=TABHEADING, IMAGE=gglogo, IMAGEBREAK=ON, POSITION=(.25 .25),  
    SIZE=(.5 .5), ALT='Gotham Grinds Logo Image', $  
GRID=OFF, $  
ENDSTYLE  
END
```

The output is:



Report on Units Sold

<u>Product</u>	<u>Unit Sales</u>
Biscotti	421377
Capuccino	189217
Coffee Grinder	186534
Coffee Pot	190695
Croissant	630054
Espresso	308986
Latte	878063
Mug	360570
Scone	333414
Thermos	190081

Add a Background Image

This syntax applies to an HTML report.

```
[TYPE=REPORT,] BACKIMAGE=url, $
```

where:

TYPE=REPORT

Applies the image to the entire report. Not required, as it is the default.

url

Is the URL of a GIF or JPEG file. Specify a file on your local Web server, or on a server accessible from your network.

The URL can be an absolute or relative address. See [Image Attributes](#).

When specifying a GIF file, you can omit the file extension.

Adding a Background Image

This request adds a background image to a report. The image file CALM_BKG.GIF resides in the relative address shown.

```
TABLE FILE GGSales
SUM UNITS DOLLARS
BY CATEGORY BY PRODUCT
ON TABLE SET PAGE-NUM OFF
ON TABLE HOLD FORMAT HTML
ON TABLE SET STYLE *
TYPE=REPORT, STYLE=BOLD, GRID=OFF, $
TYPE=REPORT, BACKIMAGE=C:\IMAGES\CALM_BKG.GIF, $
ENDSTYLE
END
```

The background is tiled across the report area:

<u>Category</u>	<u>Product</u>	<u>Unit Sales</u>	<u>Dollar Sales</u>
Coffee	Capuccino	189217	2381590
	Espresso	308986	3906243
	Latte	878063	10943622
Food	Biscotti	421377	5263317
	Croissant	630054	7749902
	Scone	333414	4216114
Gifts	Coffee Grinder	186534	2337567
	Coffee Pot	190695	2449585
	Mug	360570	4522521
	Thermos	190081	2385829

Add an Image to a PDF, PS, or HTML Report With Internal Cascading Style Sheet

This syntax applies to a PDF, PS, or HTML report with internal cascading style sheet.

```
TYPE={REPORT|heading}, IMAGE={url|file|(column)}
[,POSITION=( [+|-]x [+|-]y )] [,SIZE=(w h)] , $
```

where:

REPORT

Embeds an image in the body of a report. The image appears in the background of the report. This value is the default.

heading

Embeds an image in a heading or footing. Valid values are TABHEADING, TABFOOTING, FOOTING, HEADING, SUBHEAD, and SUBFOOT.

Provide sufficient blank space in the heading or footing so that the image does not overlap the heading or footing text. Also, you may want to place heading or footing text to the right of the image using spot markers or the POSITION attribute in the StyleSheet.

url

HTML report with internal cascading style sheet:

Is the absolute or relative address for the image file. The image must exist in a separate file in a format that your browser supports, such as GIF or JPEG. The file can be on your local Web server, or on any server accessible from your network. For details, see [Specifying a URL](#).

file

PDF or PS report:

Is the name of the image file. On z/OS, the name can be the DDNAME to which the image sequential file or data set member is allocated or the file name. The file has DCB attributes RECFM=FB,LRECL=1024. To transfer an image to the Mainframe, use FTP in BINARY mode.

When specifying a GIF file, you can omit the file extension.

column

Is an alphanumeric field in the data source that contains the name of an image file. Use the COLUMN attribute described in [Identifying an Entire Report, Column, or Row](#). Enclose *column* in parentheses.

The field containing the file name must be a display field or BY field referenced in the request.

Note that the value of the field is interpreted exactly as if it were typed as the URL of the image in the StyleSheet. If you omit the suffix, '.GIF' is supplied by default. SET BASEURL can be useful for supplying the base URL of the images; if you do this, the value of the field doesn't have to include the complete URL.

This syntax is useful, for example, if you want to embed an image in a SUBHEAD, and you want a different image for each value of the BY field on which the SUBHEAD occurs.

POSITION

Is the starting position of the image.

+|-

Measures the horizontal or vertical distance from the upper left corner of the report component in which the image is embedded.

x

Is the horizontal starting position of the image from the upper left corner of the physical report page, expressed in the unit of measurement specified by the UNITS parameter.

Enclose the *x* and *y* values in parentheses; do not include a comma between them.

y

Is the vertical starting position of the image from the upper left corner of the physical report page, expressed in the unit of measurement specified by the UNITS parameter.

SIZE

Is the size of the image. By default, an image is added at its original size.

w

Is the width of the image, expressed in the unit of measurement specified by the UNITS parameter.

Enclose the *w* and *h* values in parentheses; do not include a comma between them.

h

Is the height of the image, expressed in the unit of measurement specified by the UNITS parameter.

Adding a GIF Image to an HTML Report With Internal Cascading Style Sheet

The TYPE attribute adds the image to the report heading. POSITION places the image .35 inch horizontally and .25 inch vertically from the upper left corner of the report page. The image is one inch wide and one inch high as specified by SIZE.

```

SET HTMLCSS = ON
TABLE FILE GGSales
SUM UNITS BY PRODUCT
ON TABLE SUBHEAD
"REPORT ON UNITS SOLD"
" "
" "
" "
" "
" "
" "
" "
ON TABLE SET PAGE-NUM OFF
ON TABLE HOLD FORMAT HTML
ON TABLE SET STYLE *
TYPE=REPORT, GRID=OFF, $
TYPE=TABHEADING, IMAGE=C:\IMAGES\GOTHAM.GIF,
POSITION=(.35 .25), SIZE=(1 1), $
ENDSTYLE
END

```

The company logo is positioned and sized in the report heading:

REPORT ON UNITS SOLD	
	
<u>Product</u>	<u>Unit Sales</u>
Biscotti	421377
Capuccino	189217
Coffee Grinder	186534
Coffee Pot	190695
Croissant	630054
Espresso	308986
Latte	878063
Mug	360570
Scone	333414
Thermos	190081

Adding a GIF Image to a PDF Report

The image file for this example is GOTHAM.GIF. The POSITION attribute places the image one-quarter inch horizontally and one-quarter vertically from the upper left corner of the report page. The image is one-half inch wide and one-half inch high as specified by SIZE.

```
DYNAM ALLOC DD GIF DA USER1.GOTHAM.GIF SHR REU
TABLE FILE GGSales
SUM UNITS BY PRODUCT
ON TABLE SUBHEAD
"Report on Units Sold"
" "
" "
" "
" "
" "
ON TABLE SET PAGE-NUM OFF
ON TABLE HOLD FORMAT PDF
ON TABLE SET STYLE *
TYPE=TabHeading, IMAGE=GOTHAM.GIF, POSITION=(.25 .25), SIZE=(.5 .5), $
ENDSTYLE
END
```

The output is:

Report on Units Sold



<u>Product</u>	<u>Unit Sales</u>
Biscotti	421377
Capuccino	189217
Coffee Grinder	186534
Coffee Pot	190695
Croissant	630054
Espresso	308986
Latte	878063
Mug	360570
Scone	333414
Thermos	190081

Linking in a Report

You can use StyleSheet declarations to define links from any report component. You can create links from report data (including headings and footings) as well as graphic images (such as a company logo or product image).

Linking to a URL

You can define a link from any report component to any URL. Once you have defined a link, you can select the report component to access the URL.

Link to a URL

```
TYPE=type, [subtype], URL=url[(parameters ...)], [TARGET=frame,]$
```

where:

type

Identifies the report component that you select in the Web browser to execute the link. The TYPE attribute and its value must appear at the beginning of the declaration.

subtype

Are any additional attributes, such as COLUMN, LINE, or ITEM, that are needed to identify the report component that you are formatting.

url

Identifies any valid URL, including a URL that specifies a CGI program, or the name of a report column enclosed in parentheses whose value is a valid URL to which the link will jump.

Note:

- The maximum length of a URL=*url* argument, including any associated variable=object parameters, is 2400 characters. The URL argument can span more than one line.
- If the URL refers to a CGI program that takes parameters, the URL must end with a question mark (?).

parameters

Values that are passed to the URL.

frame

Identifies the target frame in the Web page in which the output from the link is displayed. For details, see [Specifying a Target Frame](#).

Linking to a URL

The following example illustrates how to link to a URL from a report. The heading *Click here to access the IB homepage* is linked to the URL <http://www.ibi.com>. The relevant StyleSheet declarations are highlighted in the request.

```
TABLE FILE GGSALES
ON TABLE SET PAGE-NUM OFF
SUM UNITS AND DOLLARS
```

```

BY CATEGORY BY REGION
HEADING
"Regional Sales Report"
"Click here to access the IB homepage."
" "
ON TABLE SET STYLE *
TYPE=REPORT, GRID=OFF, $
TYPE=HEADING, LINE=2, OBJECT=TEXT, ITEM=1,
  URL=http://www.ibi.com, $
ENDSTYLE
END

```

The output is:

Regional Sales Report			
Click here to access the IB homepage.			
<u>Category</u>	<u>Region</u>	<u>Unit Sales</u>	<u>Dollar Sales</u>
Coffee	Midwest	332777	4178513
	Northeast	335778	4164017
	Southeast	350948	4415408
	West	356763	4473517
Food	Midwest	341414	4338271
	Northeast	353368	4379994
	Southeast	349829	4308731
	West	340234	4202337
Gifts	Midwest	230854	2883881
	Northeast	227529	2848289
	Southeast	234455	2986240
	West	235042	2977092

When you click the link, the site appears in your browser.

Linking to a JavaScript Function

You can use a StyleSheet to define a link to a JavaScript function from any report component. Once you have defined the link, you can select the report component to execute the JavaScript function.

You can specify optional parameters that allow values to be passed to the JavaScript function. The function will use the passed value to dynamically determine the results that are returned to the browser.

**Note:**

- JavaScript functions can, in turn, call other JavaScript functions.
- You cannot specify a target frame if you are executing a JavaScript function. However, the JavaScript function itself can specify a target frame for its results.

Link to a JavaScript Function

```
TYPE=type, [subtype], JAVASCRIPT=function[(parameters ...)], $
```

where:

type

Identifies the report component that you select in the Web browser to execute the link. The TYPE attribute and its value must appear at the beginning of the declaration.

subtype

Are any additional attributes, such as COLUMN, LINE, or ITEM, that are needed to identify the report component that you are formatting.

function

Identifies the JavaScript function to run when you select the report component.

The maximum length of a JAVASCRIPT=function argument, including any associated parameters, is 2400 characters and can span more than one line. If you split a single argument across a line, you must use the \ character at the end of the first line, as continuation syntax. If you split an argument at a point where a space is required as a delimiter, the space must be before the \ character or be the first character on the next line. The \ character does not act as the delimiter.

parameters

Values that are passed to the JavaScript function.

Linking With Conditions

You can create conditions when linking from a report. For example, you may be interested in displaying only the current salaries for a particular department. You can accomplish this by creating a WHEN condition.

Link With Conditions

To specify a conditional link to a URL use:

```
TYPE=type, [subtype], URL=url[(parameters...)],  
    WHEN=expression,[TARGET=frame,] $
```

To specify a conditional link to a JavaScript function use

```
TYPE=type, [subtype], JAVASCRIPT=function[(parameters...)],  
    WHEN=expression,[TARGET=frame,] $
```

where:

type

Identifies the report component that you select in the Web browser to execute the link. The TYPE attribute and its value must appear at the beginning of the declaration.

subtype

Are any additional attributes, such as COLUMN, LINE, or ITEM, that are needed to identify the report component that you are formatting.

url

Identifies any valid URL, or the name of a report column enclosed in parentheses whose value is a valid URL.

function

Identifies the JavaScript function to run when you select the report component.

parameters

Values that are passed to the URL.

expression

Is any Boolean expression that would be valid on the right side of a COMPUTE expression.

i Note: IF... THEN... ELSE logic is not necessary in a WHEN clause and is not supported. All non-numeric literals in a WHEN expression must be specified within single quotation marks.

frame

Identifies the target frame in the Web page in which the output from the link is displayed. For details, see [Specifying a Target Frame](#).

Linking With Conditions

Assume you want to link only the MIS value of the DEPARTMENT field to the URL. To do this we include the phrase WHEN=DEPARTMENT EQ 'MIS' in the StyleSheet declaration. The relevant declarations are highlighted in the requests.

```
TABLE FILE EMPLOYEE
SUM CURR_SAL AS 'Total,Current,Salaries'
BY DEPARTMENT AS 'Department'
ON TABLE SET PAGE-NUM OFF
ON TABLE HOLD FORMAT HTML
ON TABLE SET STYLE *
TYPE=REPORT, GRID=OFF, $
TYPE=DATA, COLUMN=N1, URL=http://www.informationbuilders.com,
  WHEN=DEPARTMENT EQ 'MIS', $
ENDSTYLE
END
```

In the following output, note that only the MIS department is linked:

<u>Department</u>	<u>Total Current Salaries</u>
MIS	\$108,002.00
PRODUCTION	\$114,282.00

Linking From a Graphic Image

You can link from an image in an HTML report. The image can be attached to the entire report or to the report heading or footing (this includes table headings/table footings, and sub-headings/sub-footings).

The syntax for linking from a graphic image is the same as when linking from a report component. The only difference is that you add `IMAGE=image` to the StyleSheet declaration.

Note: You can only link from an image when you are using HTML format.

Specify Links From a Graphic Image

```
TYPE=type, [subtype], IMAGE=image, URL=url
[(parameters ...)],[TARGET=frame,] $
```

where:

type

Identifies the report component that the user selects to execute the link. The TYPE attribute and its value must appear at the beginning of the declaration. You can specify the following types of components:

TABHEADING or TABFOOTING enables you to link from a graphical image that is attached to a report heading or footing.

HEADING or FOOTING enables you to link from a graphical image that is attached to a page heading or footing.

SUBHEAD or SUBFOOT enables you to link from a graphical image that is attached to a sub heading or sub footing.

subtype

Are any additional attributes, such as COLUMN, LINE, or ITEM, that are needed to identify the report component that you are formatting.

image

Specifies the file name of a graphical image file. The image must exist as a separate graphic file in a format that your browser supports. Most browsers support GIF and JPEG file types.

You can specify a local image file, or identify an image elsewhere on the network using a URL. URLs can be absolute, such as `http://www.ibi.com/graphic.gif`, or relative aliases that can be identified to the Web server, such as `/aproot/ibinccen/graphic.gif`.

Alternatively, you can specify an alphanumeric field in the report (either a BY sort field or a display field) whose value corresponds to the name of the image file.

url

Identifies any valid URL, or the name of a report column enclosed in parentheses whose value is a valid URL.

parameters

Are values that are passed to the URL. You can pass one or more parameters. The entire string of parameters must be enclosed in parentheses, and separated from each other by a blank space.

frame

Identifies the target frame in the Web page in which the output from the link is displayed. For details, see [Specifying a Target Frame](#).

Specifying a Link From an Image

The following example illustrates how to link a URL from an image. The relevant StyleSheet declarations are highlighted in the request.

```
TABLE FILE EMPLOYEE
PRINT LAST_NAME BY EMP_ID
HEADING
"List Of Employees By Employee ID"
ON TABLE SET PAGE-NUM OFF
ON TABLE HOLD FORMAT HTML
ON TABLE SET STYLE *
TYPE=HEADING, STYLE=BOLD, $
TYPE=REPORT, GRID=OFF, $
TYPE=REPORT, IMAGE=C:\IMAGES\LEFTLOGO.GIF,
```

```

URL=HTTP://INFORMATIONBUILDERS.COM, $
ENDSTYLE
END

```

The output is:



List Of Employees By Employee ID

<u>EMP ID</u>	<u>LAST NAME</u>
071382660	STEVENS
112847612	SMITH
117593129	JONES
119265415	SMITH
119329144	BANNING
123764317	IRVING
126724188	ROMANS
219984371	MCCOY
326179357	BLACKWOOD
451123478	MCKNIGHT
543729165	GREENSPAN
818692173	CROSS

When you click the graphic, the Information Builders Web site opens.

Specifying a Base URL

If you want to create a link but do not know the full, physical URLs, you can specify a default location where the browser searches for relative URLs.

To specify a default URL location, use the SET BASEURL command. Using SET BASEURL puts `<BASE HREF="url">` into the HTML file that FOCUS generates. When a report is run, the specified directory is searched for the files that are called by the generated Web page.

Specify a Base URL

```
SET BASEURL=url
```

where:

url

Is the fully-qualified directory in which additional files reside. If it points to a Web server, the URL must begin with `http://`. The URL MUST end with a closing delimiter (`/` or `\`).

Specifying a Base URL

The following illustrates how to specify a base URL:

```
SET BASEURL=http://www.informationbuilders.com/ibi_html/newcentcorp/  
images/
```

If you are including a graphic image in your report that is stored in the specified base URL, you can add the following declaration to your StyleSheet instead of typing the entire URL:

```
TYPE=HEADING, IMAGE=leftlogo.gif, ..., $
```

i Note: If the URL is at a remote website, it may take longer to retrieve. Whenever possible, store graphic image files on your system.

Specifying a Target Frame

You can use frames to subdivide application HTML pages into separate scrollable sections. Frames enable users to explore various information items on a page by scrolling through a section, instead of linking to a separate page. When defining a link from a report component, you can specify that the results of the link be displayed in a target frame on a Web page.

There are two ways to specify a target frame. You can specify:

- A target frame in a StyleSheet declaration using the TARGET attribute. You can use StyleSheets to specify that links from a report or graph are displayed in a target frame on the Web page displaying the report or graph. However, using StyleSheets to specify target frames adds extra HTML syntax to every HREF that is generated.
- A default target frame with a SET command. SET TARGETFRAME puts the HTML code `<BASE TARGET="framename">` into the header of the HTML file that FOCUS opens. All links from the report are directed to the specified frame, unless overridden by the TARGET attribute in the StyleSheet.

To use the TARGET attribute or the SET TARGETFRAME command, you must create multiple frames on the Web page.

Specify a Target Frame

To specify a target frame for a URL, use

```
TYPE=type, [subtype], URL=url[(parameters ...)], [TARGET=frame,] $
```

where:

type

Identifies the report component that the user selects in the Web browser to execute the link. The TYPE attribute and its value must appear at the beginning of the declaration.

subtype

Are any additional attributes, such as COLUMN, LINE, or ITEM, that are needed to identify the report component that you are formatting.

url

Identifies any valid URL, or the name of a report column enclosed in parentheses whose value is a valid URL to which the link will jump. For details about linking to an URL, see [Linking to a URL](#).

parameters

Are values being passed to the URL. You can pass one or more parameters. The entire string of values must be enclosed in parentheses, and separated from each other by a blank space.

frame

Identifies the target frame in the Web page in which the output from the link is displayed.

If the name of the target frame contains embedded spaces, the name will be correctly interpreted without enclosing the name in quotation marks. For example:

```
TYPE=DATA, COLUMN=N1,
FOCEXEC=MYREPORT, TARGET=MY FRAME, $
```

The name of the target frame is correctly interpreted to be MY FRAME.

You can also use the following standard HTML frame names: _BLANK, _SELF, _PARENT, _TOP.

Specify a Default Target Frame

```
SET TARGETFRAME=frame
```

where:

frame

Identifies the target frame in the Web page in which the output from the link is displayed.

Specifying a Target Frame

The following illustrates how to specify a default target frame:

```
SET TARGETFRAME=_SELF
```

The following illustrates how to specify a target frame in a request. The relevant StyleSheet declaration is highlighted in the request.

```
TABLE FILE EMPLOYEE
PRINT CURR_SAL
```

```

BY DEPARTMENT
ON TABLE HOLD FORMAT HTML
ON TABLE SET STYLE *
TYPE=DATA, COLUMN=N1, URL=http:\\www.informationbuilders.com,
    TARGET=_SELF, $
ENDSTYLE
END

```

Linking Report Pages

With a StyleSheet, you can insert one or more navigational hyperlinks in a multi-page HTML report. This feature makes it easy for you to link consecutive report pages together without creating individual hyperlinks for each page.

You can define any report component as a hyperlink.

Link Report Pages

Use the following syntax in an HTML report

```
URL=#_destination, $
```

where:

destination

Is one of the following:

#_next goes to the top of the next report page.

#_previous goes to the top of the previous report page.

#_top goes to the top of the current report page.

#_start goes to the first page of the report.



#_end goes to the last page of the report.

Linking Report Pages Through Images in a Heading

This request displays two images in the page heading of a long report. It creates a link between BULLET.GIF and the next page of the report, and GOBACK.GIF and the previous page of the report.



```
TABLE FILE GGORDER
ON TABLE SUBHEAD
"COFFEE GRINDER SALES BY STORE"
" "
HEADING
"Next page or previous page."
PRINT QUANTITY AS 'Ordered Units' BY STORE_CODE BY PRODUCT NOPRINT
BY ORDER_NUMBER
WHERE PRODUCT EQ 'Coffee Grinder'
ON STORE_CODE PAGE-BREAK
ON TABLE HOLD FORMAT HTML
ON TABLE SET STYLE *
TYPE=REPORT, GRID=OFF, $
TYPE=TABHEADING, STYLE=BOLD,$
TYPE=HEADING, IMAGE=C:\IMAGES\BULLET, URL=#_next, IMAGEALIGN=LEFT,$
TYPE=HEADING, IMAGE=C:\IMAGES\GOBACK, URL=#_previous, IMAGEALIGN=RIGHT,$
ENDSTYLE
END
```

The images are displayed in each page heading.

PAGE 1		
COFFEE GRINDER SALES BY STORE		
	Next page or previous page.	
		
<u>Store Code</u>	<u>Order Number</u>	<u>Ordered Units</u>
R1019	9	265
	189	148
	369	382
	549	325
	729	381
	909	41
	1086	295
	1266	221

Click the image on the left of page 1 to display page 2:

PAGE 2

 Next page or previous page. 

<u>Store Code</u>	<u>Order Number</u>	<u>Ordered Units</u>
R1020	24	133
	204	380
	384	279
	564	357
	744	189
	924	90
	1101	248
	1281	221
	1461	262
	1641	83
	1821	184

Click the "go back" image on page 2 to redisplay page 1.

Linking Pages Through Page Number and Heading Elements

This request creates hyperlinks from the page number to the next page in the report, and from the text of the page heading, which appears at the top of every report page, back to the previous page or to the first page.

```
TABLE FILE GGORDER
ON TABLE SUBHEAD
"COFFEE GRINDER SALES BY STORE"
" "
HEADING
"return to previous page"
"return to beginning"
PRINT QUANTITY AS 'Ordered Units' BY STORE_CODE BY PRODUCT NOPRINT
BY ORDER_NUMBER
WHERE PRODUCT EQ 'Coffee Grinder'
ON STORE_CODE PAGE-BREAK
ON TABLE HOLD FORMAT HTML
ON TABLE SET STYLE *
TYPE=REPORT, GRID=OFF, $
```

```

TYPE=TABHEADING, STYLE=BOLD,$
TYPE=PAGENUM, URL=#_next, $
TYPE=HEADING, LINE=1, URL=#_previous, $
TYPE=HEADING, LINE=2, URL=#_start, $
ENDSTYLE
END

```

The first page is:

[PAGE 1](#)

COFFEE GRINDER SALES BY STORE

[return to previous page](#)
[return to beginning](#)

<u>Store Code</u>	<u>Order Number</u>	<u>Ordered Units</u>
R1019	9	265
	189	148
	369	382
	549	325
	729	381
	909	41
	1086	295
	1266	221
	1446	122

Click the page number three times to move to PAGE 4:

[PAGE 4](#)

[return to previous page](#)
[return to beginning](#)

<u>Store Code</u>	<u>Order Number</u>	<u>Ordered Units</u>
R1041	54	292
	234	165
	414	229
	594	208
	774	294
	953	276
	1131	137
	1311	278
	1491	289

Click **previous page** to return to PAGE 3. Click **return to beginning** to go directly to PAGE 1.

Defining a Hyperlink Color for a Report Component

You can use the HYPERLINK-COLOR attribute in a StyleSheet to designate a color for a hyperlink within a report. This applies to all hyperlinks generated in the report. You can define a single color for the entire report or different colors for each individual component.

Define a Hyperlink Color

```
TYPE = type, HYPERLINK-COLOR = color
```

where:

type

Is the report component you wish to affect. You can apply this keyword to the entire report using TYPE=REPORT. The attribute can also individually be set for any other element of the report.

color

Can use any style-sheet supported color value designation.

Defining a Hyperlink Color

The following PDF request illustrates how to define hyperlink colors for the entire report, as well as individual elements.

- The default font color for the entire report is grey and the default hyperlink color for the entire report is slate blue.
- For the Dollar Sales column (DOLLARS), the font color is green and the hyperlink color is purple.

- For both the Dollar Sales column (DOLLARS) and the Unit Sales column (UNITS), conditional styling has been applied using the same condition (REGION GE 'O').
- For the Unit Sales column (UNITS), when the conditional styling is met, the hyperlink color is inherited from the default hyperlink color for the report (slate blue).
- For the Dollar Sales column (DOLLARS), when the conditional styling is met, the hyperlink color is purple.

```
TABLE FILE GGSales
SUM DOLLARS/D12CM UNITS/D12C
BY REGION
BY CATEGORY
HEADING
"Hyperlinks of Many Colors"
""
ON TABLE SET PAGE-NUM OFF
ON TABLE HOLD AS PDFHYP FORMAT PDF
ON TABLE SET STYLE *
TYPE=REPORT, SQUEEZE=ON, FONT=ARIAL, GRID=OFF, COLOR=GREY,
HYPERLINK-COLOR='SLATE BLUE',$
TYPE=DATA, COLUMN=UNITS, WHEN=REGION GE 'O',
URL='http://www.tibco.com', $
TYPE=DATA, COLUMN=DOLLARS, COLOR=GREEN, HYPERLINK-COLOR='PURPLE',$
TYPE=DATA, COLUMN=DOLLARS, WHEN=REGION GE 'O',
URL='http://www.tibco.com', $
ENDSTYLE
END
```

The output is:

Hyperlinks of Many Colors

<u>Region</u>	<u>Category</u>	<u>Dollar Sales</u>	<u>Unit Sales</u>
Midwest	Coffee	\$4,178,513	332,777
	Food	\$4,404,483	346,421
	Gifts	\$2,931,349	234,463
Northeast	Coffee	\$4,201,057	339,155
	Food	\$4,445,197	357,919
	Gifts	\$2,848,289	227,529
Southeast	Coffee	\$4,435,134	352,357
	Food	\$4,308,731	349,829
	Gifts	\$3,037,420	237,928
West	Coffee	\$4,493,483	358,426
	Food	\$4,204,333	340,367
	Gifts	\$2,977,092	235,042

Working With Mailing Labels and Multi-Pane Pages

You can print sheets of mailing labels by dividing each page into a matrix of sub-pages, each corresponding to a single label. Each page break in the report positions the printer at the top of the next label.

Multi-pane printing places a whole report on a single printed page. You can create columns or rows so that when text overflows on one page, it appears in the next column or row on the same page rather than on the next page.

These features apply to a PDF or PS report.

Attributes for Mailing Labels and Multi-Pane Printing

In addition to the attributes in the table, you can use standard margin attributes (for example, LEFTMARGIN or TOPMARGIN) to position the entire sheet of labels at once, creating an identical margin for each sheet.

Attribute	Description	Applies to
PAGEMATRIX	Sets the number of columns and rows of labels on a page.	PDF PS
ELEMENT	Sets the width and height of each label, expressed in the unit of measurement specified by the UNITS parameter.	PDF PS
GUTTER	Sets the horizontal and vertical distance between each label, expressed in the unit of measurement specified by the UNITS parameter.	PDF PS
MATRIXORDER	Sets the order in which the labels are printed.	PDF PS
LABELPROMPT	Sets the position of the first label on the mailing label sheet.	PDF PS

Set Up a Report to Print Mailing Labels

Procedure

1. Create the label as a page heading.
2. Sort the labels but use NOPRINT to suppress sort field display. Only the fields embedded in the page heading will print.
3. Insert a page break on a sort field to place each new field value on a separate label.
4. Suppress default page numbers and associated blank lines from the beginning of each page (SET PAGE-NUM=NOPAGE).

Print Mailing Labels or a Multi-Pane Report

```
[TYPE=REPORT,] PAGEMATRIX=(cr), ELEMENT=(w h), [GUTTER=(x y),]  
[MATRIXORDER={VERTICAL|HORIZONTAL},] [LABELPROMPT={OFF|ON},] $
```

where:

TYPE=REPORT

Applies the settings to the entire report. Not required, as it is the default.

c

Is the number of columns of labels across the page.

Enclose the values *c* and *r* in parentheses, and do not include a comma between them.

r

Is the number of rows of labels down the page.

w

Is the width of each label.

Enclose the values *w* and *h* in parentheses, and do not include a comma between them.

h

Is the height of each label.

GUTTER

Is the distance between each label.

x

Is the horizontal distance between each label.

Enclose the values *x* and *y* in parentheses, and do not include a comma between them.

y

Is the vertical distance between each label.

MATRIXORDER

Is the order in which the labels are printed.

VERTICAL

Prints the labels down the page.

HORIZONTAL

Prints the labels across the page.

LABELPROMPT

Is the position of the first label on the mailing label sheet.

OFF

Starts the report on the first label on the sheet. This value is the default.

ON

Prompts you at run time for the row and column number at which to start printing. All remaining labels follow consecutively. This feature allows partially used sheets of labels to be reused.

Printing Mailing Labels

The following report prints on 8 1/2 x 11 sheets of address labels.

```
TABLE FILE EMPLOYEE
BY LAST_NAME NOPRINT BY FIRST_NAME NOPRINT
ON FIRST_NAME PAGE-BREAK
HEADING
"<FIRST_NAME <LAST_NAME"
"<ADDRESS_LN1"
"<ADDRESS_LN2"
"<ADDRESS_LN3"
ON TABLE SET PAGE-NUM NOPAGE
ON TABLE HOLD FORMAT PDF
ON TABLE SET STYLE LABEMP
END
```

The labels have the following dimensions, defined in the StyleSheet LABEMP:

```
UNITS=IN, PAGESIZE=LETTER, LEFTMARGIN=0.256, TOPMARGIN=0.5,
PAGEMATRIX=(2 5), ELEMENT=(4 1), GUTTER=(0.188 0), $
```

The first page of labels prints as follows:

JOHN BANNING 160 LOMBARDO AVE. APT 4C FREEPORT NY 11520	DIANE JONES 235 MURRAY HIL PKWY RUTHERFORD NJ 07073
ROSEMARIE BLACKWOOD MRS. P. JONES 3704 FARRAGUT RD. BROOKLYN NY 11210	JOHN MCCOY ASSOCIATED 2 PENN PLAZA NEW YORK NY 10001
BARBARA CROSS APT 2G 147-15 NORTHERN BLD FLUSHING NY 11354	ROGER MCKNIGHT APT 4D 117 HARRISON AVE. ROSELAND NJ 07068
MARY GREENSPAN 13 LINDEN AVE. JERSEY CITY NJ 07300	ANTHONY ROMANS 271 PRESIDENT ST. FREEPORT NY 11520
JOAN IRVING APT 2J 123 E 32 ST. NEW YORK NY 10001	MARY SMITH ASSOCIATED 2 PENN PLAZA NEW YORK NY 10001

Printing a Multi-Page Report

This request divides the first report page in two columns so that the second report page appears in the second column of the first page. A PAGE-BREAK creates a multi-page report for the purpose of this example.

```
TABLE FILE EMPLOYEE
PRINT LAST_NAME AND CURR_SAL BY DEPARTMENT
ON DEPARTMENT PAGE-BREAK
HEADING
"PAGE <TABPAGENO"
ON TABLE HOLD FORMAT PDF
ON TABLE SET STYLE *
UNITS=IN, PAGESIZE=LETTER, PAGEMATRIX=(2 1), ELEMENT=(3.5 8.0),
MATRIXORDER=VERTICAL, $
TYPE=REPORT, SIZE=8, $
END
```

The report prints as:

PAGE 1	DEPARTMENT	LAST_NAME	CURR_SAL	PAGE 2	DEPARTMENT	LAST_NAME	CURR_SAL
	MIS	SMITH	\$13,200.00		PRODUCTION	STEVENS	\$11,000.00
		JONES	\$18,480.00			SMITH	\$9,500.00
		MCCOY	\$18,480.00			BANNING	\$29,700.00
		BLACKWOOD	\$21,780.00			IRVING	\$26,862.00
		GREENSPAN	\$9,000.00			ROMANS	\$21,120.00
		CROSS	\$27,062.00			MCKNIGHT	\$16,100.00

Choosing a Styled Display Format

Some advanced features of styled report output depend on whether the report is produced as HTML, PDF, PostScript, Excel 2000, or Excel 97 format. These features are described in this chapter.

Some display formats are best suited for particular kinds of uses. For example, you can choose to display the report as:

- An HTML page, which is optimized for display in a web browser.
- A PDF document, which is useful when you want the report to look the same whether displayed on a screen or printed.
- A DHTML file, which is HTML output that has most of the features normally associated with output formatted for printing, such as PDF or PostScript output.
- An Excel 2000 worksheet, where you can work with the data in Excel 2000 or 2003.

You can learn which display formats are available in [Report Display Formats](#).

If you wish to send a report to a file instead of to the screen, you can learn about the file formats that are available in [Saving and Reusing Your Report Output](#).

Report Display Formats

You can choose from among several display formats for your report:

- **Web format:** HTML. For more information, see [Using Web Display Format: HTML](#).
- **Print formats:** PDF (Adobe Acrobat Portable Document Format) and PostScript (PS). For more information, see [Using Print Display Formats: PDF, PS](#).
- **Worksheet formats:** Excel 2000/2003 HTML-based format, with variations for Excel 2000 PivotTable and Excel 2000 FORMULA, Excel 97 HTML-based format, and Excel binary format. For more information, see [Saving Report Output in Excel XLSX Format](#).

A note about DHTML and HTML: DHTML is the absolute positioning version of HTML. As architected, format HTML generates output in a table-based format that leaves the exact positioning to the browser that is presenting the report. Format DHTML on the other hand

is designed to render with the user-defined positioning in the same way as PDF. This means things should be positioned on the page precisely as defined in the report procedure. PDF, DHTML, PPT, PPTX, and PS are position-based. HTML and EXL2K are table or cell based. Therefore, DHTML output looks more like PDF rather than HTML.

For information about which file formats are available for saving and reusing (as opposed to displaying) report data, see [Saving and Reusing Your Report Output](#).

i Note: For styled output formats, setting the LINES parameter to 999 or higher generates continuous forms. When continuous forms are specified, but the output format has a physical page size (as is the case with PDF output), the column titles repeat at the top of the physical page, without page numbers.

For information about creating a StyleSheet, identifying and styling report components, and choosing a styled output format, see [Styling Reports](#).

For advanced StyleSheet techniques and features that apply to styled output formats, see [Advanced StyleSheet Features](#).

Choose a Display Format Using PCHOLD

You can display a report on screen using the ON TABLE PCHOLD command in a report request.

```
ON TABLE PCHOLD FORMAT formatname
```

where:

formatname

Can be one of the following:

DOC	Specifies that the report will be displayed as a plain-text word-processing document, with page breaks, in Microsoft Word within your web browser. See Using Word Processing Display Formats: DOC, WP .
-----	-------------------------------------------------------------------------------------------------------------------------------------------------------------------------------------------------------------------------

EXCEL	Specifies that the report will be displayed as an Excel spreadsheet. See Saving Report Output in Excel XLSX Format .
XLSX	Specifies that the report will be displayed as an Excel 2007/2010 worksheet. See Saving Report Output in Excel XLSX Format .
EXL2K	Specifies that the report will be displayed as an Excel 2000/2003 worksheet. See Assigning EXL2K Format to Your Report Output .
EXL2K FORMULA	Specifies that the report will be displayed as an Excel 2000/2003 worksheet, with WebFOCUS totals and other calculated values translated to active Excel formulas. (If your report does not contain any formulas, consider using EXL2K format since EXL2K FORMULA requires additional processing time.) See Assigning EXL2K Format to Your Report Output .
EXL2K PIVOT	Specifies that the report will be displayed as an Excel 2000/2003 PivotTable. See Assigning EXL2K Format to Your Report Output .
EXL97	Specifies that the report will be displayed as an Excel 97 worksheet.
HTML	Specifies that the report will be displayed as an HTML page. See Using Web Display Format: HTML .
PDF	Specifies that the report will be displayed as a PDF document (Adobe Acrobat's Portable Document Format). See Using PDF Display Format .
PostScript (PS)	Specifies that the report will be displayed as a PostScript document. You must have installed a third-party tool capable of displaying PS. See Using PostScript (PS)

	Display Format.
WP	Specifies that the report will be displayed as a plain-text word processing document in the web browser. See Using Word Processing Display Formats: DOC, WP.

Choose a Display Format Using SET ONLINE-FMT

For a limited set of formats, you can display a report on screen using the SET command ONLINE-FMT parameter.

Outside of a report request, use the following syntax to specify a format for all report requests within the procedure

```
SET ONLINE-FMT = formatname
```

Within a report request, use the following syntax to specify a format for that request only

```
ON TABLE SET ONLINE-FMT formatname
```

where:

formatname

Can be one of the following:

HTML (default)	Specifies that the report will be displayed as an HTML page. See Using Web Display Format: HTML.
PDF	Specifies that the report will be displayed as a PDF document (Adobe Acrobat Portable Document Format). See Using PDF Display Format.
XLSX	Specifies that the report will be displayed as an Excel

	2007/2010 worksheet. See Saving Report Output in Excel XLSX Format .
EXL2K	Specifies that the report will be displayed as an Excel 2000/2003 worksheet. See Assigning EXL2K Format to Your Report Output .
EXL97	Specifies that the report will be displayed as an Excel 97 worksheet.
PostScript (PS)	Specifies that the report will be displayed as a PostScript document. You must have installed a third-party tool capable of displaying PS. See Using PostScript (PS) Display Format .
STANDARD	Specifies that the report will be displayed using a legacy character-based and line-based layout and a monospaced font.



Tip: ONLINE-FMT syntax will be superseded by PCHOLD syntax in future releases of WebFOCUS (see [Choose a Display Format Using PCHOLD](#)). At present, they can be used interchangeably.

Specifying MIME Types for WebFOCUS Reports

In addition to creating reports in HTML format for display in a web browser, you can generate reports that can be returned to the browser and opened in a desktop application or in a helper application. In order for the browser to recognize and call the correct desktop application, you must associate the MIME (Multipurpose Internet Mail Extension) type of the report with a specific application.

For details, see the *ibi™ WebFOCUS® Developing Reporting Applications* manual.

Preserving Leading and Internal Blanks in Report Output

By default, HTML browsers and Excel remove leading and trailing blanks from text and compress multiple internal blanks to a single blank.

If you want to preserve leading and internal blanks in HTML and EXL2K report output, you can issue the SET SHOWBLANKS=ON command.

Even if you issue this command, trailing blanks will not be preserved except in heading, subheading, footing, and subfooting lines that use the default heading or footing alignment.

Preserve Leading and Internal Blanks in HTML and EXL2K Reports

In a FOCEXEC, on the command line, or in a profile, use the following syntax:

```
SET SHOWBLANKS = {OFF|ON}
```

In a request, use the following syntax

```
ON TABLE SET SHOWBLANKS {OFF|ON}
```

where:

OFF

Removes leading blanks and compresses internal blanks in HTML and EXL2K report output.

ON

Preserves leading blanks and internal blanks in HTML and EXL2K report output. Also preserves trailing blanks in heading, subheading, footing, and subfooting lines that use the default heading or footing alignment.

Preserving Leading and Internal Blanks in HTML and EXL2K Report Output

The following request creates a virtual field that adds leading blanks to the value ACTION and both leading and internal blanks to the values TRAIN/EX and SCI/FI in the CATEGORY field. It also adds trailing blanks to the value COMEDY:

```

SET SHOWBLANKS = OFF
DEFINE FILE MOVIES
NEWCAT/A30 = IF CATEGORY EQ 'ACTION' THEN '  ACTION'
            ELSE IF CATEGORY EQ 'SCI/FI' THEN 'SCIENCE  FICTION'
            ELSE IF CATEGORY EQ 'TRAIN/EX' THEN '  TRAINING    EXERCISE'
            ELSE IF CATEGORY EQ 'COMEDY' THEN 'COMEDY      '
            ELSE                'GENERAL';
END
TABLE FILE MOVIES
SUM CATEGORY LISTPR/D12.2 COPIES
BY NEWCAT
ON TABLE HOLD FORMAT HTML
ON TABLE SET STYLE *
GRID=OFF,$
TYPE=REPORT, FONT=COURIER NEW,$
ENDSTYLE
END

```

With SHOWBLANKS OFF, these additional blanks are removed:

<u>NEWCAT</u>	<u>CATEGORY</u>	<u>LISTPR</u>	<u>COPIES</u>
TRANING EXERCISE	TRAIN/EX	119.87	10
ACTION	ACTION	94.82	14
COMEDY	COMEDY	154.80	19
GENERAL	MYSTERY	1,216.82	67
SCIENCE FICTION	SCI/FI	114.84	7

With SHOWBLANKS ON, the additional leading and internal blanks are preserved. Note that trailing blanks are not preserved:

<u>NEWCAT</u>		<u>CATEGORY</u>	<u>LISTPR</u>	<u>COPIES</u>
TRNING	EXERCISE	TRAIN/EX	119.87	10
ACTION		ACTION	94.82	14
COMEDY		COMEDY	154.80	19
GENERAL		MYSTERY	1,216.82	67
SCIENCE	FICTION	SCI/FI	114.84	7

Using Web Display Format: HTML

You can display a report as an HTML page. HTML supports most style sheet options (especially when used with an internal cascading style sheet), allowing for full report formatting.

By default, leading and internal blanks are compressed on the report output. For information on preserving them, see [Preserving Leading and Internal Blanks in Report Output](#).

Usage Notes for HTML Report Output

- The default behavior for HTML format when borders are turned on is to display column titles without the underline. To display column titles with underlines when borders are on, set GRID OFF.
- The AUTOFIT parameter automatically resizes the HTML report output to fit the container (window or frame). For procedures that contain multiple report outputs, if AUTOFIT is set to ON in any of the report output procedures, the setting will apply to all report output on the page.

AUTOFIT is supported using the Accordion, On-Demand Paging, HTML TOC, and HFREEZE interactive reporting features.

For more information on the AUTOFIT parameter, see the *ibi™ WebFOCUS® Developing Reporting Applications* manual.

Creating HTML Reports With Absolute Positioning

Format DHTML provides HTML output that has most of the features normally associated with output formatted for printing such as PDF or PostScript output. You can create an HTML file (.htm) or a Web Archive file (.mht). The type of output file produced is controlled by the value of the HTMLARCHIVE parameter.

Some of the features supported by format DHTML are:

- **Absolute positioning.** DHTML precisely places text and images inside an HTML report, allowing you to use the same StyleSheet syntax to lay out HTML as you use for PDF or PS output.
- **On demand paging.** On demand paging is available with SET HTMLARCHIVE=OFF.
- **PDF StyleSheet features.** For example, the following features are supported: grids, background colors, OVER.

Create Web Archive Report Output

```
SET HTMLARCHIVE = {ON|OFF}
```

where:

ON

Creates output in Web Archive format. The file type of the output file is MHT.

OFF

Creates output in HTML format. The file type of the output file is HTM. OFF is the default value.

Create a DHTML Report

```
[ON TABLE] HOLD [AS name] FORMAT DHTML
```

where:

name

Specifies the name of the output file. The extension will be HTML if SET HTMLARCHIVE is OFF or MHT if SET HTMLARCHIVE is ON.

Usage Notes for Format DHTML

- The font map file for DHTML reports is member DHTML in the ERRORS data set.
- Legacy compound reports are not supported.

Creating a DHTML Report

The following example creates a DHTML file that has an image with absolute positioning:

```
SET HTMLARCHIVE = OFF
TABLE FILE GGSales
SUM UNITS BY CATEGORY BY PRODUCT
ON TABLE SUBHEAD
"Report on Units Sold"
" "
" "
" "
" "
" "
ON TABLE SET PAGE-NUM OFF
ON TABLE HOLD FORMAT DHTML
ON TABLE SET STYLE *
TYPE=TABHEADING,IMAGE=c:\images\GOTHAM.GIF, POSITION=(.25 .25),
SIZE=(.5 .5), $
ENDSTYLE
END
```

The output shows that the look and positioning are the same as they would be for a PDF report:

Report on Units Sold



<u>Category</u>	<u>Product</u>	<u>Unit Sales</u>
Coffee	Capuccino	189217
	Espresso	308986
	Latte	878063
Food	Biscotti	421377
	Croissant	630054
	Scone	333414
Gifts	Coffee Grinder	186534
	Coffee Pot	190695
	Mug	360570
	Thermos	190081

Using Print Display Formats: PDF, PS

PDF (Adobe Acrobat Portable Document Format) is most often used to distribute and share electronic documents through the web. It is especially useful if you want a report to maintain its presentation and layout regardless of a browser or printer type. For details, see [Using PDF Display Format](#).

PS (PostScript format), a print-oriented page description language, is most often used to send a report directly to a printer. While used less frequently as an online display format, you can display PS report output on your monitor before printing it. For details, see [Using PostScript \(PS\) Display Format](#).

FOCUS generates a PDF or PS document from scratch. In order to do so, it must physically embed all the objects it displays or prints, including images and fonts, in the document itself.

When you execute a report request and specify PDF or PS as your format, FOCUS retrieves the data and begins to format the report. Fonts and images specified in the StyleSheet must be available to create the output file. FOCUS reads the font information from font files and embeds that information in the document.

To ensure that FOCUS can locate the required information, you must define and map it in the following files:

- **Font file, usually a PFB (Printer Font Binary) file.** This file contains the information about the shape to draw for each character of the font. The information in the font file is scalable, which means that a single font file can be used to generate characters of any size. Note, however, that bold and italic variations of the typeface are separate fonts. An alternative ASCII format, PFA, can also be used by FOCUS.

Note that the basic fonts delivered with FOCUS do not need PFA or PFB files. Acrobat Reader and PostScript printers already have the descriptions of these fonts.

- **Adobe Font Metrics (AFM) file.** This file is distributed with all Adobe fonts. It contains information about the size of each character in each font. FOCUS uses this information to lay out the report on the page. Note that the three built-in fonts also have AFM files, which are distributed with FOCUS. However, these fonts don't require font files, since the fonts are built into Acrobat.

i Note: A Printer Metrics File (PFM) is also available. This file is used by applications such as Acrobat Reader for laying out text; however, it is not supported by FOCUS. You must use the AFM file.

- **FOCUS Font Map file.** This configuration file maps the name of a font to the appropriate font and font metrics files (AFM and PFB or PFA).

Required Files and DDNAMES

When you produce a PostScript or PDF report, you need the following files:

Name	Purpose	z/OS
StyleSheet files. You can create them with a text editor (see Styling Reports).	Define the styles in reports.	Any member of the data set allocated to ddname FOCSTYLE. Alternatively, you can specify the StyleSheet in your report request and eliminate the need for a separate StyleSheet file.

Name	Purpose	z/OS
Adobe Font Metrics (AFM) files (supplied with FOCUS).	Define the measurements of characters for PostScript and PDF output.	Member names start with PS. Allocated to ddname ERRORS.
Font location file (supplied with FOCUS).	Maps font names to the Font Metrics files.	Members FONTMAP and FONTUSER in the data set allocated to ddname ERRORS.
Output files. You create these with a HOLD, SAVE, or SET command.	Contain the formatted output.	DDNAME is HOLD or the AS name assigned in the HOLD command.

Note that if you add fonts, you also need PFA or PFB files for those fonts.

Using PDF Display Format

You can display a report as a PDF document. PDF (Adobe Acrobat Portable Document Format) supports most StyleSheet attributes, allowing for full report formatting. The wide range of StyleSheet features supported for PDF are described throughout this documentation.

PDF prints and displays a document consistently, regardless of the application software, hardware, and operating system used to create or display the document.

The report opens in Adobe Acrobat or Acrobat Reader within a web browser. To display a PDF report, a computer must have Adobe Acrobat Reader installed. For free downloads of Acrobat Reader, go to <http://www.adobe.com>.

Limit: Adobe Acrobat PDF format limits the number of pages, hyperlinks, and images in a document. For information about what limits this creates for a FOCUS report in PDF format, see [Saving and Reusing Your Report Output](#).

Other print-oriented display formats. You can also display a report as a PostScript document. For more information, see [Using PostScript \(PS\) Display Format](#).

Compress a PDF Output File

File compression can be used to minimize the physical size of the PDF output file. Using this PDF-specific feature, you can generate smaller PDF files, making them easier to store and distribute, while having no visible effect on the formatting or content of the reports they contain.

```
SET FILECOMPRESS = {ON|OFF}
```

where:

ON

Compresses PDF output files.

OFF

Does not compress PDF output files. OFF is the default value.

This command applies to PDF output only. It is ignored by all other output formats, such as HTML and Excel.

Displaying Watermarks in PDF Output

Watermarks are images or text strings that are placed on the bottom layer of a document and displayed through the transparent layered content.

FOCUS bgcolor does not support transparency. Therefore, standard images placed below it on the page may be obscured. To resolve this, in PDF reports, FOCUS mirrors the approach taken by standard printers, and places an opaque image on the top of the document layers. With this approach, the layers of the document will be visible beneath the transparent watermark image.

Watermark images are provided by the report developer. When creating a transparent image, the image needs to be created in GIF format with a transparent background.

Inserting Images in PDF Reports With Backcolor

Watermarks are supported for PDF output in compound reports and in single TABLE requests. Each document supports a single active watermark image. This image is designated as the watermark image, by defining the placement order within the Z-INDEX attribute.

The first image with a Z-INDEX value will be considered the active watermark for the current document. Any subsequent images, defined with style sheet attributes for Z-INDEX or OPACITY, will be displayed as standard FOCUS images.

Watermark images are designated by defining the following attributes in the style sheet for the transparent GIF.

Z-INDEX=TOP	Designates that the image is to be handled as a watermark image and should always be placed on top of all other objects on the page. This value will be respected as the topmost layer and will be supported with other layers in future releases.
OPACITY= <i>n</i>	Where <i>n</i> represents the percent (%) of OPACITY to be applied to the image. The greater the OPACITY, the less transparent the image. Less of the underlying report will be visible below the image. The value for <i>n</i> can be any number from 0 through 100. If a value is not specified, it defaults to 100%, presenting a fully opaque image.

Within a single TABLE request:

```
TYPE=<REPORT|HEADING>, OBJECT=IMAGE, IMAGE=<image.gif>,
Z-INDEX=TOP, OPACITY=15, POSITION=(.25 .25), DIMENSION=(8 10.5), $
```

Inserting Transparent Images Into a PDF Report

The following request against the GGSales data source places the coffee image (coffee.gif) on the page and layers the watermark image (internalonlyport.gif) on top. These images are displayed on every page of the report.

```

TABLE FILE GGSALES
SUM
    GGSALES.SALES01.DOLLARS/D12CM
    GGSALES.SALES01.UNITS/D12C
    GGSALES.SALES01.BUDDOLLARS/D12CM
    GGSALES.SALES01.BUDUNITS/D12C
BY GGSALES.SALES01.REGION
BY GGSALES.SALES01.CATEGORY
BY GGSALES.SALES01.PRODUCT
HEADING
"Gotham Grinds"
"Product Sales By Region"
ON TABLE SET PAGE-NUM NOLEAD
ON TABLE NOTOTAL
ON TABLE HOLD FORMAT PDF
ON TABLE SET HTMLCSS ON
ON TABLE SET STYLE *
    INCLUDE = endeflt,
    TOPMARGIN=.5,
    BOTTOMMARGIN=.5,
    LEFTMARGIN=1,
    RIGHTMARGIN=1,
$
TYPE=REPORT,
    OBJECT=IMAGE,
    IMAGE=internalonlyport.gif,
    POSITION=(+0.70000 +0.70000),
    SIZE=(7 7.5),
    Z-INDEX=TOP, OPACITY=15,
$
TYPE=REPORT,
    OBJECT=IMAGE,
    IMAGE=coffee.gif,
    POSITION=(+1.0 +0.5),
    SIZE=(.5 .5),
$ENDSTYLE
END

```

The output is:



Gotham Grinds
Product Sales By Region

Region	Category	Product	Dollar Sales	Unit Sales	Budget Dollars	Budget Units
Midwest	Coffee	Espresso	\$1,294,947	101,154	\$1,258,232	101,869
		Latte	\$2,883,566	231,623	\$2,827,800	233,657
	Food	Biscotti	\$1,091,727	86,105	\$1,067,629	85,839
		Croissant	\$1,751,124	139,182	\$1,708,733	139,648
		Scone	\$1,495,420	116,127	\$1,444,359	113,776
	Gifts	Coffee Grinder	\$619,154	50,393	\$613,453	50,628
		Coffee Pot	\$599,878	47,156	\$614,007	47,779
		Mug	\$1,086,943	86,718	\$1,096,150	87,092
		Thermos	\$577,906	46,587	\$564,010	46,819
	Northeast	Coffee	Capuccino	\$542,095	44,785	\$561,491
Espresso			\$850,107	68,127	\$872,902	69,776
Latte			\$2,771,815	222,866	\$2,818,069	221,712
Food		Biscotti	\$1,802,005	145,242	\$1,848,682	145,152
		Croissant	\$1,670,818	137,394	\$1,739,522	137,864
		Scone	\$907,171	70,732	\$865,703	68,415
Gifts		Coffee Grinder	\$509,200	40,977	\$511,642	41,297
		Coffee Pot	\$590,780	46,185	\$573,349	45,404
		Mug	\$1,144,211	91,497	\$1,170,314	90,540
		Thermos	\$604,098	48,870	\$615,247	49,767
Southeast	Coffee	Capuccino	\$944,000	73,264	\$956,661	75,353
		Espresso	\$853,572	68,030	\$849,465	66,785
		Latte	\$2,617,836	209,654	\$2,625,303	213,555
	Food	Biscotti	\$1,505,717	119,594	\$1,512,019	120,549
		Croissant	\$1,902,359	156,456	\$1,969,906	157,148
		Scone	\$900,655	73,779	\$927,363	73,812
	Gifts	Coffee Grinder	\$605,777	47,083	\$569,585	46,784
		Coffee Pot	\$645,303	49,922	\$654,579	50,637
		Mug	\$1,102,703	88,474	\$1,124,345	89,371
		Thermos	\$632,457	48,976	\$618,745	48,253
West	Coffee	Capuccino	\$895,495	71,168	\$877,304	70,585
		Espresso	\$907,617	71,675	\$923,941	72,927
		Latte	\$2,670,405	213,920	\$2,722,718	215,272
	Food	Biscotti	\$863,868	70,436	\$861,804	67,780
		Croissant	\$2,425,601	197,022	\$2,406,554	195,329
		Scone	\$912,868	72,776	\$914,886	72,252
	Gifts	Coffee Grinder	\$603,436	48,081	\$571,316	47,397
		Coffee Pot	\$613,624	47,432	\$630,196	49,208
		Mug	\$1,188,664	93,881	\$1,156,976	93,629
		Thermos	\$571,368	45,648	\$575,818	46,402

Features Supported

The following core PDF features are supported with watermarks:

- Standard TABLE requests, including reports with paneling
- Compound syntax (OPEN/CLOSE)
- Drillthrough

- Bookmarks
- Borders/backcolor

Limits

- OPACITY must be between 0 and 100, inclusive.
- A single watermark image is supported for a single document.

Usage Notes

- For compound syntax, the watermark image must be in the first report. If it is not in the first report, a FOC3362 message is generated.
- The embedded PDF viewer for a browser may not display NLS characters correctly. If NLS characters do not display correctly, use font embedding, as described in [Adding PostScript Type 1 Fonts for PS and PDF Formats](#), or configure your browser to use Adobe Reader.

Scaling PDF Report Output to Fit the Page Width

By default, if PDF report output is too wide to fit on a single page, the report generates multiple panels of the same page for the columns that do not fit. The page numbers specify the page and panel numbers. For example, page numbers 1.1 and 1.2 represent page 1/panel 1 and page 1/panel 2.

You can scale the output to fit across the width of the page using the PAGE-SCALE StyleSheet attribute or the PAGE-SCALE SET parameter.

Scale PDF Report Output to Fit the Page Width

In a StyleSheet, use the following syntax.

```
TYPE=REPORT, PAGE-SCALE={OFF|AUTO}, $
```

In a procedure or profile, use the following syntax.

```
SET PAGE-SCALE = {OFF|AUTO}
```

In a request, use the following syntax.

```
ON TABLE SET PAGE-SCALE {OFF|AUTO}
```

where:

OFF

Disables page scaling in PDF report output. This is the default value.

AUTO

Implements page scaling in PDF report output.

Usage Notes for PAGE-SCALE

- PAGE-SCALE is supported for PDF report output only.
- When a page is scaled to fit more content on the page horizontally, fewer vertical pages may be generated, as well.

Scaling PDF Report Output to Fit the Page Width

The following request generates PDF report output without page scaling.

```
TABLE FILE GGSALES  
SUM DOLLARS BUDDOLLARS UNITS BUDUNITS  
BY CATEGORY  
BY PRODUCT  
BY REGION  
BY ST  
BY CITY
```

```
WHERE CATEGORY EQ 'Food' OR 'Gifts'
ON TABLE HOLD AS PGSCALE1 FORMAT PDF
END
```

The output is too wide for the page and is paneled. Page 1.1 has the columns that fit across the width of the page, as shown in the following image.

<u>Category</u>	<u>Product</u>	<u>Region</u>	<u>State</u>	<u>City</u>
Food	Biscotti	Midwest	IL	Chicago
			MO	St. Louis
			TX	Houston
		Northeast	CT	New Haven
			MA	Boston
			NY	New York
		Southeast	FL	Orlando
			GA	Atlanta
			TN	Memphis
		West	CA	Los Angeles
			CA	San Francisco
		Food	Croissant	Midwest
IL	Chicago			
MO	St. Louis			
Northeast	TX			Houston
	CT			New Haven
	MA			Boston
Southeast	NY			New York
	FL			Orlando
	GA			Atlanta
West	TN			Memphis
	CA			Los Angeles
Food	Scone			Midwest
		IL	Chicago	
		MO	St. Louis	
		Northeast	TX	Houston
			CT	New Haven
			MA	Boston
		Southeast	NY	New York
			FL	Orlando
			GA	Atlanta
		West	TN	Memphis
			CA	Los Angeles
		Gifts	Coffee Grinder	Midwest
IL	Chicago			
MO	St. Louis			
Northeast	TX			Houston
	CT			New Haven
	MA			Boston
Southeast	NY			New York
	FL			Orlando
	GA			Atlanta
West	TN			Memphis
	CA			Los Angeles
Gifts	Coffee Pot			Midwest
		IL	Chicago	
		MO	St. Louis	
		Northeast	TX	Houston
			CT	New Haven
			MA	Boston
		Southeast	NY	New York
			FL	Orlando
			GA	Atlanta
		West	TN	Memphis
			CA	Los Angeles
		Gifts	Mug	Midwest
IL	Chicago			
MO	St. Louis			
Northeast	TX			Houston
	CT			New Haven
	MA			Boston
Southeast	NY			New York
	FL			Orlando
	GA			Atlanta
West	TN			Memphis
	CA			Los Angeles

Page 1.2 has the remaining columns, as shown in the following image.

PAGE		1.2		
Dollar	Sales	Budget Dollars	Unit Sales	Budget Units
417469		422397	32321	32941
368077		360403	29188	28764
363438		340295	28904	28391
634580		620381	49229	49144
570391		616766	47064	48246
662237		658781	53500	51808
511597		516984	40606	41242
555231		568743	43639	44362
438889		426292	35349	34945
268026		247780	20906	19699
269518		273054	22987	21943
328320		345143	26676	26459
549366		528255	43300	43271
619991		602785	49451	50131
590722		590005	47130	47228
551489		580168	45847	46335
497234		519322	41029	41351
622095		640032	50518	50178
602076		644884	50175	51437
661806		666934	53782	54126
638477		658088	52499	51585
800084		808357	66049	64432
824457		799141	65214	66025
801060		799056	65759	64872
595069		567231	45355	45091
481953		478691	37602	36573
418398		398437	33170	32112
283874		269221	22378	21038
324486		312004	25363	23774
290811		284478	22991	23603
311836		299547	24543	24576
273420		294886	22863	22427
315399		332930	26373	26809
315584		287477	23595	23067
292839		305848	24093	24094
304445		321561	25088	25091
280760		289747	22948	23011
181570		171501	14614	14779
204292		200241	16440	16625
169908		159620	13691	13117
177940		187686	14382	15384
161352		164336	12904	12796
268384		247445	20441	20340
217254		202101	16968	16423
171319		161057	13147	13304
214557		200567	16845	16563
187123		178246	14864	14815
201756		192503	16372	16019
204828		208255	15785	16035
190153		191451	14807	14970
204897		214301	16564	16774
208209		197051	15523	15190
184119		184071	15349	15171
198452		192227	15313	15043
212057		215467	16145	16470
232552		247789	18431	19042
200694		191323	15346	15125
202285		203774	15278	16203
197845		215775	15783	16273
213494		210647	16371	16732
376754		388612	30157	30881
343852		324488	27040	26837
366337		383050	29521	29374
392967		424333	31728	32415
401944		401617	32360	31324
349300		344364	27409	26801
409466		391236	31628	31590
355447		384262	29746	29860
337790		348847	27100	27921
381926		365269	30279	30043

The following version of the request uses page scaling.

```
TABLE FILE GGSales
SUM DOLLARS BUDDOLLARS UNITS BUDUNITS
BY CATEGORY
BY PRODUCT
BY REGION
BY ST
BY CITY
WHERE CATEGORY EQ 'Food' OR 'Gifts'
ON TABLE HOLD AS PGSCALE2 FORMAT PDF
```

```
ON TABLE SET STYLE *
TYPE=REPORT, PAGE-SCALE=AUTO,$
ENDSTYLE
END
```

The output is shown in the following image. All of the columns fit across the width of the page, with no paneling.

Category	Product	Region	State	City	Dollar Sales	Budget Dollars	Unit Sales	Budget Units	
Food	Biscotti	Midwest	IL	Chicago	417449	422397	32321	32941	
			MO	St. Louis	368077	360403	29188	28764	
			TX	Houston	343438	340395	26904	26391	
		Northeast	CT	New Haven	634580	620361	49229	49144	
			MA	Boston	570291	616766	47064	48246	
			NY	New York	662227	658781	53500	51808	
	Southeast	FL	Orlando	511597	515984	40606	41242		
		GA	Atlanta	555231	569743	43639	44262		
		TN	Memphis	438889	426292	35349	34945		
	Croissant	Midwest	West	CA	Los Angeles	268026	247780	20906	19699
				CA	San Francisco	29516	27054	2387	21943
				WA	Seattle	328320	345143	26676	26459
Northeast			IL	Chicago	549366	529255	43200	43200	
			MO	St. Louis	613991	602785	49451	50131	
			TX	Houston	590723	590005	47330	47228	
Southeast		CT	New Haven	521489	518018	45847	46107		
		MA	Boston	497234	519322	41029	41351		
		NY	New York	612095	640032	50518	50178		
Scone		Midwest	West	FL	Orlando	602076	644884	50175	51437
				GA	Atlanta	661906	666934	53782	54126
				TN	Memphis	638477	658088	52499	51585
	Northeast		CA	Los Angeles	800084	809357	66049	64432	
			CA	San Francisco	824457	799141	65214	64025	
			WA	Seattle	801060	799056	65759	64872	
	Southeast	IL	Chicago	395069	357231	45255	45091		
		MO	St. Louis	481953	478691	37602	36573		
		TX	Houston	418298	398437	33170	32112		
	Gifts	Coffee Grinder	Midwest	CT	New Haven	293974	293201	22378	21038
				MA	Boston	332486	312004	25363	23774
				NY	New York	496811	484478	25981	25607
Northeast			FL	Orlando	111526	299549	24843	24576	
			GA	Atlanta	273420	294886	22853	22427	
			TN	Memphis	315339	312330	26733	26909	
Coffee Pot		Midwest	West	CA	Los Angeles	315584	287477	23595	23067
				CA	San Francisco	292939	305448	24093	24094
				WA	Seattle	304445	321561	25088	25091
			Northeast	IL	Chicago	280760	289747	22948	23011
				MO	St. Louis	181570	171501	14634	14779
				TX	Houston	204292	200241	16440	16625
	Mug	Coffee Pot	Midwest	CT	New Haven	145908	159220	13193	13117
				MA	Boston	177940	187686	14382	15384
				NY	New York	161352	164138	12904	12796
			Northeast	FL	Orlando	286384	247448	20441	20340
				GA	Atlanta	217254	202101	16968	16423
				TN	Memphis	171219	171057	13147	13204
Thermos		Coffee Pot	Midwest	CA	Los Angeles	214557	200567	16845	16583
				CA	San Francisco	187123	178246	14864	14616
				WA	Seattle	201766	191503	16169	16019
			Northeast	IL	Chicago	204828	209255	15785	16035
				MO	St. Louis	190253	191451	14907	14970
				TX	Houston	204997	214301	16564	16774
	Thermos	Coffee Pot	Midwest	CT	New Haven	108209	197051	15523	15190
				MA	Boston	184119	184071	15349	15411
				NY	New York	198452	192227	15313	15043
			Northeast	FL	Orlando	212057	216487	16145	16100
				GA	Atlanta	232552	247789	18431	19042
				TN	Memphis	200694	191323	15246	15126
Thermos		Mug	West	CA	Los Angeles	602285	203774	15278	16203
				CA	San Francisco	197845	215775	15783	16273
				WA	Seattle	213494	210847	16371	16732
			Northeast	IL	Chicago	376754	388612	30157	30881
				MO	St. Louis	343852	324488	27040	26937
				TX	Houston	362377	383050	29211	29741
	Thermos	Mug	Midwest	CT	New Haven	352967	424333	31728	22415
				MA	Boston	401944	401517	32650	31204
				NY	New York	349300	344364	27409	26801
			Northeast	FL	Orlando	409466	391236	31628	31590
				GA	Atlanta	355447	384262	29746	29880
				TN	Memphis	337790	348847	27100	27521
Thermos		Thermos	West	CA	Los Angeles	381926	385269	30779	30043
				CA	San Francisco	379399	369333	29484	28581
				WA	Seattle	427339	422374	34118	34005
			Northeast	IL	Chicago	187901	181159	14651	14137
				MO	St. Louis	195686	189484	15332	15903
				TX	Houston	184119	193187	16344	16779
	Thermos	Thermos	Midwest	CT	New Haven	211827	219025	17568	17667
				MA	Boston	202425	208436	16794	16921
				NY	New York	178836	187786	14568	15179
			Northeast	FL	Orlando	195526	187670	15241	14884
				GA	Atlanta	217482	225970	17578	17597
				TN	Memphis	205449	205105	16057	15902
Thermos		Thermos	West	CA	Los Angeles	207513	208569	16169	16653
				CA	San Francisco	165115	166590	13574	13374
				WA	Seattle	166440	200559	15905	16375

Aligning a PDF Report Within a Page

You can left-align, center, or right-align an entire PDF report within a page by using the JUSTIFYREPORT StyleSheet attribute.

To left-align, center, or right-align a PDF report, include the following syntax in your procedure.

```
TYPE=REPORT, JUSTIFYREPORT={LEFT|CENTER|RIGHT},$
```

Left-Aligning a PDF Report Within a Page

To left-align a PDF report, include the TYPE=REPORT, JUSTIFYREPORT=LEFT attribute, as shown in the following procedure.

```
TABLE FILE GGSALES
SUM BUDDOLLARS
BY REGION
BY CATEGORY

HEADING
"Budget Dollars By Region and Product Category "
" "

FOOTING
"End of Report "
" "

ON TABLE SET PAGE-NUM NOLEAD
ON TABLE PCHOLD FORMAT PDF

ON TABLE SET STYLE *
SQUEEZE=ON, GRID=ON, $
TYPE=REPORT,
JUSTIFYREPORT=LEFT,$
ENDSTYLE

END
```

The output is:

Budget Dollars By Region and Category		
Region	Category	Budget Dollars
Midwest	Coffee	4086032
	Food	4220721
	Gifts	2887620
Northeast	Coffee	4252462
	Food	4453907
	Gifts	2870552
Southeast	Coffee	4431429
	Food	4409288
	Gifts	2967254
West	Coffee	4523963
	Food	4183244
	Gifts	2934306

End of Report

Centering a PDF Report Within a Page

To center a PDF report, include the `TYPE=REPORT`, `JUSTIFYREPORT=CENTER` attribute, as shown in the following procedure.

```
TABLE FILE GGSales
SUM BUDDOLLARS
BY REGION
BY CATEGORY

HEADING
"Budget Dollars By Region and Product Category "
" "

FOOTING
"End of Report "
" "

ON TABLE SET PAGE-NUM NOLEAD
ON TABLE PCHOLD FORMAT PDF

ON TABLE SET STYLE *
SQUEEZE=ON, GRID=ON, $
TYPE=REPORT,
JUSTIFYREPORT=CENTER,$
ENDSTYLE

END
```

The output is:

Budget Dollars By Region and Category		
Region	Category	Budget Dollars
Midwest	Coffee	4086032
	Food	4220721
	Gifts	2887620
Northeast	Coffee	4252462
	Food	4453907
	Gifts	2870552
Southeast	Coffee	4431429
	Food	4409288
	Gifts	2967254
West	Coffee	4523963
	Food	4183244
	Gifts	2934306

End of Report

Right-Aligning a PDF Report Within a Page

To right-align a PDF report, include the `TYPE=REPORT`, `JUSTIFYREPORT=RIGHT` attribute, as shown in the following procedure.

```
TABLE FILE GGSales
SUM BUDDOLLARS
BY REGION
BY CATEGORY

HEADING
"Budget Dollars By Region and Product Category "
" "

FOOTING
"End of Report "
" "

ON TABLE SET PAGE-NUM NOLEAD
ON TABLE PCHOLD FORMAT PDF

ON TABLE SET STYLE *
SQUEEZE=ON, GRID=ON, $
TYPE=REPORT,
JUSTIFYREPORT=RIGHT,$
ENDSTYLE

END
```

The output is:

Budget Dollars By Region and Category		
Region	Category	Budget Dollars
Midwest	Coffee	4086032
	Food	4220721
	Gifts	2887620
Northeast	Coffee	4252462
	Food	4453907
	Gifts	2870552
Southeast	Coffee	4431429
	Food	4409288
	Gifts	2967254
West	Coffee	4523963
	Food	4183244
	Gifts	2934306

End of Report

WebFOCUS PDF Report Accessibility Support

WebFOCUS PDF report accessibility provides support for assistive technologies, such as screen readers.



Note: For information on accessibility principles and font types and usage, see the WebAIM website at <https://webaim.org/techniques/fonts/#intro>.

WebFOCUS PDF report output complies with accessibility requirements as a result of the following features:

- A SET command that activates accessibility changes to WebFOCUS PDF output code.
- As of Release 8206, a DisplayOn=DOC-HEADING StyleSheet attribute that identifies the main document heading in a compound report.
 - In a single standalone report (non-compound document), the first ON TABLE SUBHEAD string is automatically tagged as <H1>. Other page headings and footings, as many as there are available, are tagged as <H2>.
 - In a compound report, the DisplayOn=DOC-HEADING attribute should be added to a single fixed-positioned component that will contain the ON TABLE SUBHEAD string. The DOC-HEADING attribute indicates that the ON TABLE SUBHEAD string entered in the fixed-positioned component will be tagged as <H1> and represent the main document heading, which will be displayed once on the first physical page of the document. Other page headings and footings,

as many as there are available, are tagged as <H2>.

- A USEASTITLES StyleSheet attribute that places and aligns custom column titles in a heading.
- A BOOKMARK StyleSheet attribute that enables you to go directly to a destination in a document.
- An ALT StyleSheet attribute that describes an image embedded in a report.
- An ALT StyleSheet attribute that provides a description of a drill-down component.
- A LANG attribute that identifies the default language of the document.
- Report output, with the SET ACCESSPDF command enabled, is created with BYDISPLAY=ON, which produces a value in each cell for sort (BY) fields.

i Note: It is the responsibility of the report developer to follow general accessibility standards in order for the report to be 508 compliant.

Controlling PDF Code For Accessibility

The SET ACCESSPDF command enables accessibility for PDF reports.

Control PDF Code Accessibility

- For all requests in a procedure or in a profile:

```
SET ACCESSPDF = {508|OFF}
```

- For a single request:

```
ON TABLE SET ACCESSPDF {508|OFF}
```

where:

508

Generates a PDF file compliant with Section 508 accessibility requirements.

OFF

Generates a PDF file that is non-compliant with Section 508 accessibility requirements. This value is the default.

Controlling PDF Code for Accessibility

The following request generates accessible PDF report output. The SET and SUBHEAD commands that enable accessibility appear in boldface.

```
TABLE FILE GGSales
SUM
  DOLLARS/D12M
BY REGION
BY CATEGORY
ON REGION SUBTOTAL AS 'Total for '
HEADING
" "
"Sales Report"
" "
ON TABLE SET ACCESSPDF 508
ON TABLE SET PAGE-NUM OFF
ON TABLE COLUMN-TOTAL AS 'Grand Total'
ON TABLE SUBHEAD "Regional Totals by Category"
ON TABLE PCHOLD FORMAT PDF
ON TABLE SET STYLE *
TYPE=REPORT, FONT='ARIAL', $
TYPE=TITLE, COLUMN=N1, FONT='ARIAL', STYLE=BOLD, $
TYPE=TITLE, COLUMN=N2, FONT='ARIAL', STYLE=BOLD, $
TYPE=TITLE, COLUMN=N3, FONT='ARIAL', STYLE=BOLD, $
TYPE=HEADING, SIZE=14, STYLE=BOLD, $
TYPE=TABHEADING, SIZE=16, STYLE=BOLD, $
TYPE=SUBTOTAL, BY=1, STYLE=BOLD, $
TYPE=GRANDTOTAL, FONT='ARIAL', STYLE=BOLD, $
ENDSTYLE
END
```

WebFOCUS generates the following tags when SET ACCESSPDF is set to 508.

Page Heading

Heading tags <H1> and <H2> and are automatically generated by WebFOCUS.

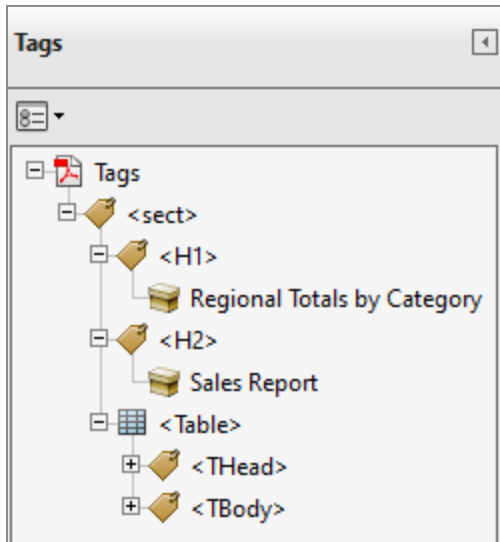

Column Titles

Row tags `<TR>` and header cell tags `<TH>` are generated by WebFOCUS. The column title is aligned with the appropriate data columns.

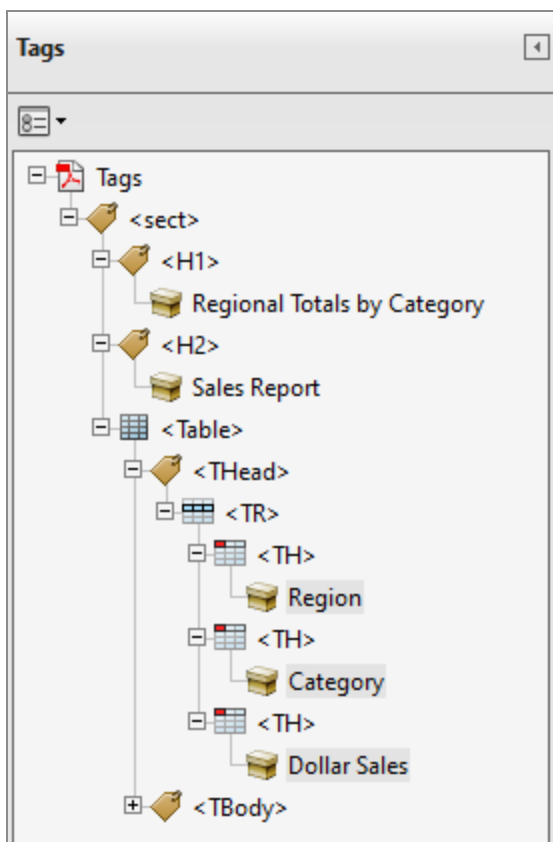

Data Cells

Row tags <TR> and header cell tags <TH> are generated by WebFOCUS.

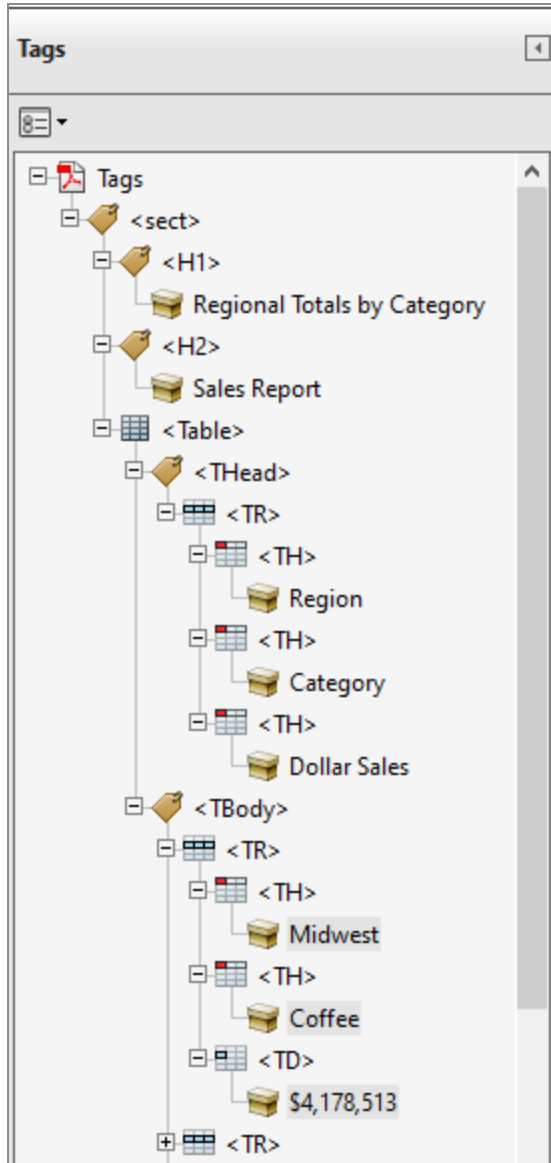

The output is:

Regional Totals by Category		
Sales Report		
<u>Region</u>	<u>Category</u>	<u>Dollar Sales</u>
Midwest	Coffee	\$4,178,513
Midwest	Food	\$4,338,271
Midwest	Gifts	\$2,883,881
Total for Midwest		\$11,400,665
Northeast	Coffee	\$4,164,017
Northeast	Food	\$4,379,994
Northeast	Gifts	\$2,848,289
Total for Northeast		\$11,392,300
Southeast	Coffee	\$4,415,408
Southeast	Food	\$4,308,731
Southeast	Gifts	\$2,986,240
Total for Southeast		\$11,710,379
West	Coffee	\$4,473,517
West	Food	\$4,202,337
West	Gifts	\$2,977,092
Total for West		\$11,652,946
Grand Total		\$46,156,290

Aligning Elements in a Page Heading With Column Data

The USEASTITLES StyleSheet attribute for PDF reports enables you to place and align custom column titles (AS='text') in the heading, rather than use the default column titles. The USEASTITLES attribute associates column titles in the heading with the appropriate data column.

Align Elements in a Page Heading With Column Data

```
TYPE=HEADING, USEASTITLES=ON, HEADALIGN=BODY,$
```

USEASTITLES=ON can only be set for the entire HEADING. HEADALIGN=BODY must also be set for the HEADING.

To use this attribute in App Studio:

- The Report Output Format is PDF.
- The Alignment Grid is enabled for the Page Heading.
 - Add a Page Heading to the report.
 - Right-click the Page Heading and select **Alignment Grid**.
 - On the Insert Alignment Grid dialog box, select the **Align with Data** option and click **OK**.
 - In the Page Heading, right-click the alignment grid and select **Align column title (Section 508)**.

Aligning Elements in a Page Heading to Column Data

The USEASTITLES attribute that enables the alignment of the heading elements is in bold. Note that the HEADALIGN=BODY attribute is also in bold.

```
TABLE FILE GGSales
SUM
  DOLLARS/D12M AS ''
BY REGION AS ''
BY CATEGORY AS ''
ON REGION SUBTOTAL AS 'Total for '
HEADING
''
'Sales Report'
```

```

" <+0> <+0> "
"Region<+0>Category<+0>Dollar Sales"
ON TABLE SET ACCESSPDF 508
ON TABLE SET PAGE-NUM OFF
ON TABLE COLUMN-TOTAL AS 'Grand Total'
ON TABLE SUBHEAD "Regional Totals by Category <+1"
ON TABLE PCHOLD FORMAT PDF
ON TABLE SET STYLE *
$
TYPE=REPORT, FONT='ARIAL', $
TYPE=TITLE, COLUMN=N1, FONT='ARIAL', STYLE=BOLD, $
TYPE=TITLE, COLUMN=N2, FONT='ARIAL', STYLE=BOLD, $
TYPE=TITLE, COLUMN=N3, FONT='ARIAL', STYLE=BOLD, $
TYPE=HEADING, SIZE=14, STYLE=BOLD,
HEADALIGN=BODY, USEASTITLES=ON, $
TYPE=HEADING, LINE=2, OBJECT=TEXT, ITEM=1, COLSPAN=3, JUSTIFY=LEFT, $
TYPE=HEADING, LINE=3, OBJECT=TEXT, ITEM=1, COLSPAN=1, JUSTIFY=LEFT, $
TYPE=HEADING, LINE=3, OBJECT=TEXT, ITEM=2, SIZE=10, COLSPAN=1,
    JUSTIFY=RIGHT, $
TYPE=HEADING, LINE=3, OBJECT=TEXT, ITEM=3, SIZE=10, COLSPAN=1,
    JUSTIFY=RIGHT, $
TYPE=HEADING, LINE=4, OBJECT=TEXT, ITEM=1, SIZE=11, COLSPAN=1,
    JUSTIFY=LEFT, $
TYPE=HEADING, LINE=4, OBJECT=TEXT, ITEM=2, SIZE=11, COLSPAN=1,
    JUSTIFY=LEFT, $
TYPE=HEADING, LINE=4, OBJECT=TEXT, ITEM=3, SIZE=11, COLSPAN=1,
    JUSTIFY=RIGHT, $
TYPE=TABHEADING, SIZE=16, STYLE=BOLD, $
TYPE=SUBTOTAL, BY=1, STYLE=BOLD, $
TYPE=GRANDTOTAL, FONT='ARIAL', STYLE=BOLD, $
ENDSTYLE
END

```

WebFOCUS generates the following tags when the USEASTITLES attribute is used.

Page Heading and Column Titles

Row tags <TR> and header cell tags <TH> are generated by WebFOCUS. Along with the Page Heading, the column titles are also tagged as header cells <TH>.

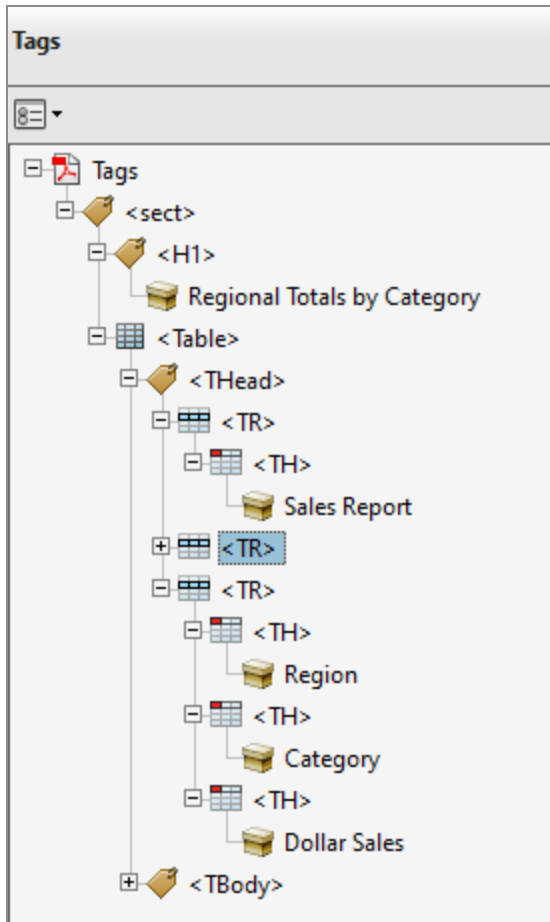

The output is:

Regional Totals by Category		
Sales Report		
Region	Category	Dollar Sales
Midwest	Coffee	\$4,178,513
Midwest	Food	\$4,338,271
Midwest	Gifts	\$2,883,881
Total for Midwest		\$11,400,665
Northeast	Coffee	\$4,164,017
Northeast	Food	\$4,379,994
Northeast	Gifts	\$2,848,289
Total for Northeast		\$11,392,300
Southeast	Coffee	\$4,415,408
Southeast	Food	\$4,308,731
Southeast	Gifts	\$2,986,240
Total for Southeast		\$11,710,379
West	Coffee	\$4,473,517
West	Food	\$4,202,337
West	Gifts	\$2,977,092
Total for West		\$11,652,946
Grand Total		\$46,156,290

Adding Bookmarks

Bookmarks are links in the navigation pane that enable you to go directly to a destination in the document. Using bookmarks enables you to jump from the tagged items in the navigation pane directly to the page where the item is located. The benefit of using bookmarks in conjunction with a screen reader is that you will be able to navigate a defined hierarchy without having to listen to the reading of the entire document. For more information about navigating PDF Bookmarks, see the Adobe documentation on the Adobe Web site, www.adobe.com.

i Note:

- Since a PDF document is a complete file, you can use bookmarks and scrolling to navigate through the file. You can easily navigate through a document, especially documents that are two or more pages in length.
- You can generate bookmarks within WebFOCUS by including the BOOKMARKS and/or TOC object in the compound layout syntax. Then, in the component definitions, specify the Table of Contents level and description. You can also optionally specify the BYTOC levels.
- For 508 compliance, it is recommended that the Bookmark object be used.

Adding Bookmarks to the Compound Layout

The BOOKMARK attribute that enables the alignment is in bold. The TOC-LEVEL=1 and BYTOC=2 attributes for both reports are also in bold. These attributes are explained below:

- TOC-LEVEL=*n*

Defines *n* as the Table of Contents level for the report layout object. This option defines the hierarchical order of objects within the Table of Contents.

0 = the object is not shown in the Table of Contents.

1 = the object is shown as a first-level item in the Table of Contents.

2 = the object is shown as a second-level item in the Table of Contents, and so on.

- BYTOC=*m*

Specifies the number of BY fields to be included within the current component entry (*m*).

The following request adds bookmarks and specifies the main document heading for the compound report. The *report0* component uses the *DisplayOn=DOC-HEADING* attribute to indicate that the ON TABLE SUBHEAD string from the report0 component should be tagged as the main document heading in the PDF output.

```
SET ACCESSPDF = 508
COMPOUND LAYOUT PCHOLD FORMAT PDF
OBJECT=BOOKMARKS,$
SECTION=S1, LAYOUT=ON, MERGE=OFF, ORIENTATION=PORTRAIT,$
PAGELAYOUT=1,$
COMPONENT=report0, position=(1 0.5), Dimension=(* *),
```

```

DisplayOn=DOC-HEADING,
$
COMPONENT=report1, TEXT='This is the Title for Report 1',
TOC-LEVEL=1,
BYTOC=2,
POSITION=(1 1), DIMENSION=(* *),$
COMPONENT=report2, TEXT='Sales By Region',
TOC-LEVEL=1,
BYTOC=2,
POSITION=(+0.00 +0.519), DIMENSION=(* *), RELATIVE-TO='report1',
REQUIRED-SPACE=(*3.5), RELATIVE-POINT=BOTTOM-LEFT, POSITION-POINT=TOP-
LEFT,$
END

```

```

SET COMPONENT=report0
TABLE FILE GGSALES
BY CATEGORY NOPRINT
ON TABLE SUBHEAD
" "
"DOLLAR SALES REPORT"
" "
" "
ON TABLE SET PAGE-NUM OFF
ON TABLE HOLD FORMAT PDF
ON TABLE SET STYLE *
TYPE=TABHEADING , SIZE=18, FONT=ARIAL, STYLE=BOLD, JUSTIFY=CENTER,$
ENDSTYLE
END

```

```

SET COMPONENT=report1
TABLE FILE GGSALES
SUM DOLLARS/F8M
BY CATEGORY
BY PRODUCT
BY REGION
BY ST
ON CATEGORY PAGE-BREAK
WHERE PRODUCT NE 'Capuccino'
ON CATEGORY SUBTOTAL AS 'Subtotal for: '
HEADING
"Sales by Category"
" "
ON TABLE HOLD FORMAT PDF
ON TABLE SET PAGE-NUM OFF
ON TABLE NOTOTAL
ON TABLE SET STYLE *

```

```

TYPE=REPORT, SIZE=10, FONT=ARIAL,$
TYPE=HEADING, SIZE=14, FONT=ARIAL, STYLE=BOLD, JUSTIFY=CENTER,$
TYPE=SUBTOTAL, SIZE=10, STYLE=BOLD,$
ENDSTYLE
END
    
```

```

SET COMPONENT=report2
TABLE FILE GGSales
SUM DOLLARS/F8M
BY REGION
BY ST
BY CATEGORY
BY PRODUCT
ON REGION PAGE-BREAK
WHERE PRODUCT NE 'Capuccino'
ON REGION SUBTOTAL AS 'Subtotal for: '
HEADING
"Sales by Region"
" "
ON TABLE HOLD FORMAT PDF
ON TABLE SET PAGE-NUM OFF
ON TABLE NOTOTAL
ON TABLE SET STYLE *
TYPE=REPORT, SIZE=10, FONT=ARIAL,$
TYPE=HEADING, SIZE=14, FONT=ARIAL, STYLE=BOLD, JUSTIFY=CENTER,$
TYPE=SUBTOTAL, SIZE=10, STYLE=BOLD,$
ENDSTYLE
END
COMPOUND END
    
```

The report output, with bookmarks, is shown below.

The screenshot shows a report viewer interface. On the left is a 'Bookmarks' sidebar with a tree view containing categories like 'Coffee', 'Food', 'Gifts', and 'Sales By Region'. The main area displays a report titled 'DOLLAR SALES REPORT' with a sub-heading 'Sales by Category'. The report is a table with columns for Category, Product, Region, State, and Dollar Sales. The data is grouped by product (Espresso and Latte) and then by region (Midwest, Northeast, Southeast, West). A subtotal row is included at the bottom for 'Coffee'.

Category	Product	Region	State	Dollar Sales
Coffee	Espresso	Midwest	IL	\$420,439
Coffee	Espresso	Midwest	MO	\$419,143
Coffee	Espresso	Midwest	TX	\$455,365
Coffee	Espresso	Northeast	CT	\$279,373
Coffee	Espresso	Northeast	MA	\$249,356
Coffee	Espresso	Northeast	NY	\$322,378
Coffee	Espresso	Southeast	FL	\$256,539
Coffee	Espresso	Southeast	GA	\$317,389
Coffee	Espresso	Southeast	TN	\$279,644
Coffee	Espresso	West	CA	\$606,079
Coffee	Espresso	West	WA	\$301,538
Coffee	Latte	Midwest	IL	\$978,340
Coffee	Latte	Midwest	MO	\$966,981
Coffee	Latte	Midwest	TX	\$938,245
Coffee	Latte	Northeast	CT	\$926,052
Coffee	Latte	Northeast	MA	\$917,737
Coffee	Latte	Northeast	NY	\$928,026
Coffee	Latte	Southeast	FL	\$889,887
Coffee	Latte	Southeast	GA	\$907,395
Coffee	Latte	Southeast	TN	\$820,584
Coffee	Latte	West	CA	\$1,745,509
Coffee	Latte	West	WA	\$924,896
Subtotal for: Coffee				\$14,849,865

Notice that the hierarchy tree in the Bookmarks pane has two levels for each report and is determined with the BYTOC attribute. The title for each report in the Bookmarks tree is determined with the TEXT attribute, as shown in the following image.

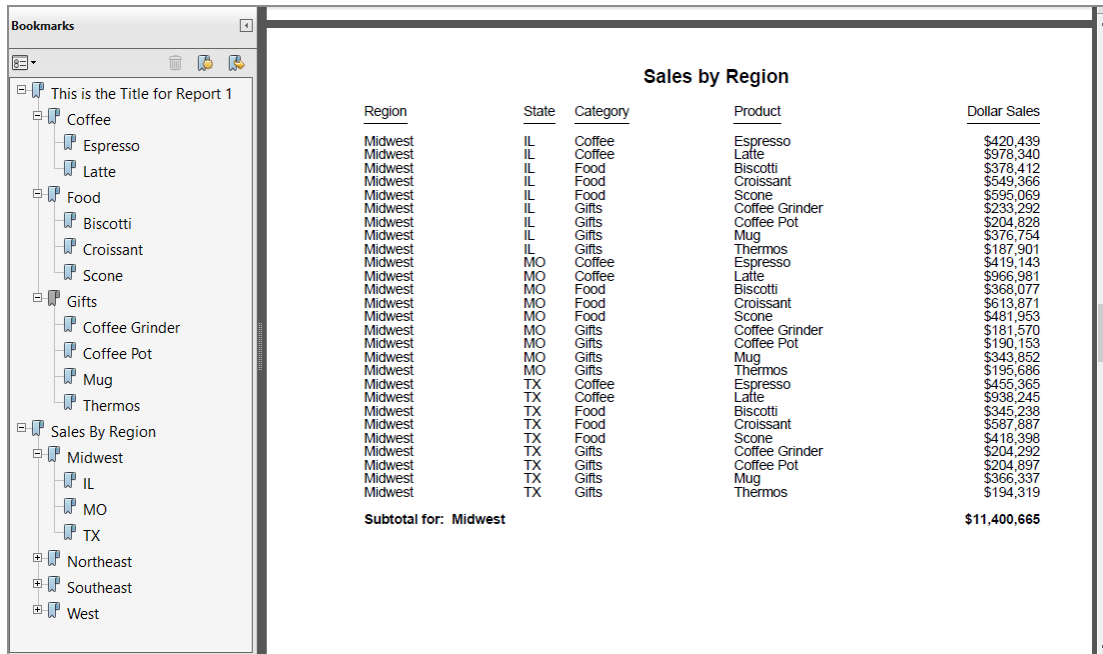

The first three pages of the PDF output, with the Tags panel, are shown in the following images. Note that only the first page of output contains the <H1> heading, DOLLAR SALES REPORT. The other headings are tagged as <H2>.

Page 1

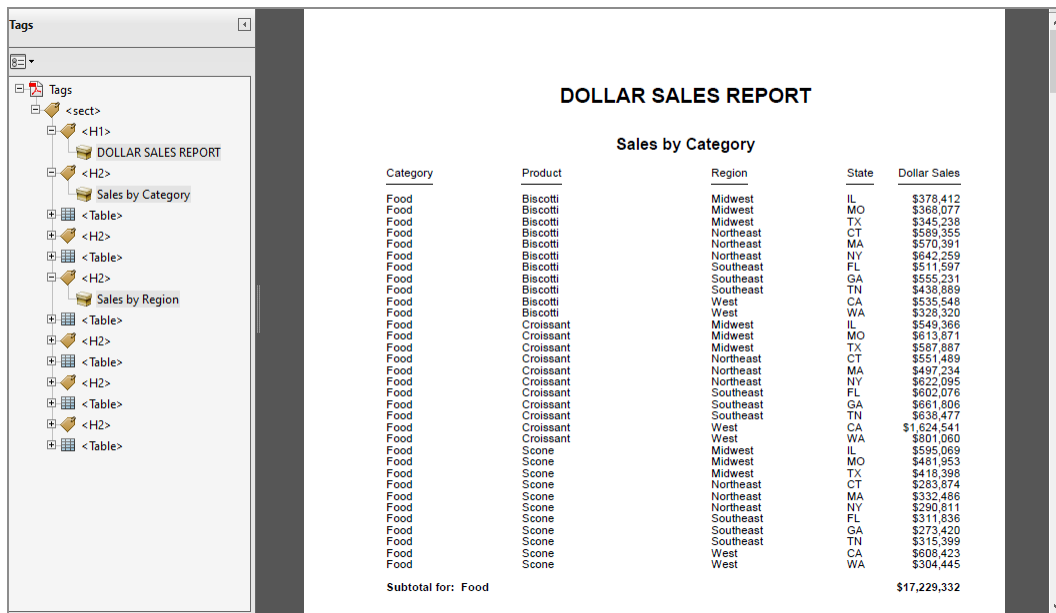

Page 2

Sales by Category

Category	Product	Region	State	Dollar Sales
Gifts	Coffee Grinder	Midwest	IL	\$233,292
Gifts	Coffee Grinder	Midwest	MO	\$181,570
Gifts	Coffee Grinder	Midwest	TX	\$204,292
Gifts	Coffee Grinder	Northeast	CT	\$169,908
Gifts	Coffee Grinder	Northeast	MA	\$177,940
Gifts	Coffee Grinder	Northeast	NY	\$161,352
Gifts	Coffee Grinder	Southeast	FL	\$217,204
Gifts	Coffee Grinder	Southeast	GA	\$217,254
Gifts	Coffee Grinder	Southeast	TN	\$171,319
Gifts	Coffee Grinder	West	CA	\$401,680
Gifts	Coffee Grinder	West	WA	\$201,756
Gifts	Coffee Pot	Midwest	IL	\$204,828
Gifts	Coffee Pot	Midwest	MO	\$190,153
Gifts	Coffee Pot	Midwest	TX	\$204,897
Gifts	Coffee Pot	Northeast	CT	\$208,209
Gifts	Coffee Pot	Northeast	MA	\$184,119
Gifts	Coffee Pot	Northeast	NY	\$198,452
Gifts	Coffee Pot	Southeast	FL	\$212,057
Gifts	Coffee Pot	Southeast	GA	\$232,552
Gifts	Coffee Pot	Southeast	TN	\$200,694
Gifts	Coffee Pot	West	CA	\$400,130
Gifts	Coffee Pot	West	WA	\$213,494
Gifts	Mug	Midwest	IL	\$376,754
Gifts	Mug	Midwest	MO	\$343,852
Gifts	Mug	Midwest	TX	\$368,337
Gifts	Mug	Northeast	CT	\$392,967
Gifts	Mug	Northeast	MA	\$401,944
Gifts	Mug	Northeast	NY	\$349,300
Gifts	Mug	Southeast	FL	\$409,466
Gifts	Mug	Southeast	GA	\$355,447
Gifts	Mug	Southeast	TN	\$337,790
Gifts	Mug	West	CA	\$761,325
Gifts	Mug	West	WA	\$427,339
Gifts	Thermos	Midwest	IL	\$187,901
Gifts	Thermos	Midwest	MO	\$195,686
Gifts	Thermos	Midwest	TX	\$194,319
Gifts	Thermos	Northeast	CT	\$221,827
Gifts	Thermos	Northeast	MA	\$203,435
Gifts	Thermos	Northeast	NY	\$178,836
Gifts	Thermos	Southeast	FL	\$195,526
Gifts	Thermos	Southeast	GA	\$227,462
Gifts	Thermos	Southeast	TN	\$208,449
Gifts	Thermos	West	CA	\$373,728
Gifts	Thermos	West	WA	\$198,640
Subtotal for: Gifts				\$11,695,502

Page 3

Sales by Region

Region	State	Category	Product	Dollar Sales
Midwest	IL	Coffee	Espresso	\$420,439
Midwest	IL	Coffee	Latte	\$979,340
Midwest	IL	Food	Biscotti	\$379,412
Midwest	IL	Food	Croissant	\$549,366
Midwest	IL	Food	Scone	\$595,069
Midwest	IL	Gifts	Coffee Grinder	\$233,292
Midwest	IL	Gifts	Coffee Pot	\$204,828
Midwest	IL	Gifts	Mug	\$376,754
Midwest	IL	Gifts	Thermos	\$187,901
Midwest	MO	Coffee	Espresso	\$419,143
Midwest	MO	Coffee	Latte	\$966,981
Midwest	MO	Food	Biscotti	\$368,077
Midwest	MO	Food	Croissant	\$513,871
Midwest	MO	Food	Scone	\$481,953
Midwest	MO	Gifts	Coffee Grinder	\$181,570
Midwest	MO	Gifts	Coffee Pot	\$190,153
Midwest	MO	Gifts	Mug	\$343,852
Midwest	MO	Gifts	Thermos	\$195,686
Midwest	TX	Coffee	Espresso	\$455,365
Midwest	TX	Coffee	Latte	\$938,245
Midwest	TX	Food	Biscotti	\$345,238
Midwest	TX	Food	Croissant	\$587,887
Midwest	TX	Food	Scone	\$410,398
Midwest	TX	Gifts	Coffee Grinder	\$204,292
Midwest	TX	Gifts	Coffee Pot	\$204,897
Midwest	TX	Gifts	Mug	\$366,337
Midwest	TX	Gifts	Thermos	\$194,319
Subtotal for: Midwest				\$11,400,665

Adding Descriptive Text to an Image

The ALT attribute in a WebFOCUS StyleSheet adds descriptive text to an embedded image in a PDF report. The ALT attribute in the StyleSheet generates a PDF ALT attribute on the tag.

The ALT tag is displayed in the PDF when you hover the mouse over the image.

Add Descriptive Text to an Image

```
ALT='description'
```

where:

description

Is a brief description of the image, enclosed in single quotation marks ('). The length can be a maximum of 256 characters.

For details on the StyleSheet syntax for adding an image, see [cr27_PageLayout218.htm#dcr27_PageLayout1183635](#).

Adding Descriptive Text to an Image

This request adds the TIBCO® logo to a report heading. It uses the WebFOCUS StyleSheet ALT attribute to add descriptive text (TIBCO logo) that identifies the image.

```
TABLE FILE GGSales
SUM
  DOLLARS/D12N
BY REGION
BY CATEGORY
ON REGION SUBTOTAL AS 'Total sales: '
ON REGION PAGE-BREAK
HEADING
"Sales Report"
" "
" "
" "
" "
" "
ON TABLE SET ACCESSPDF 508
ON TABLE SET PAGE-NUM OFF
ON TABLE NOTOTAL
ON TABLE PCHOLD FORMAT PDF
ON TABLE SUBHEAD "Regional Totals by Category"
```

```

ON TABLE SET STYLE *
  UNITS=IN,
  SQUEEZE=ON,
  ORIENTATION=PORTRAIT,
$
TYPE=REPORT, GRID=OFF, FONT='ARIAL', SIZE=9,$
TYPE=TITLE, STYLE=BOLD,$
TYPE=HEADING, SIZE=12, STYLE=BOLD, JUSTIFY=CENTER,$
TYPE=TABHEADING, SIZE=14, STYLE=BOLD, JUSTIFY=CENTER,$
TYPE=SUBTOTAL, BACKCOLOR=RGB(210 210 210), STYLE=BOLD,$
TYPE=REPORT, IMAGE=tibco.png, ALT='TIBCO logo',
POSITION=(0 .5),$
ENDSTYLE
END

```

The report is:

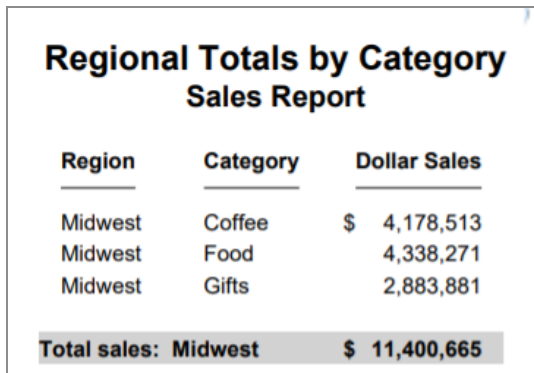

The image shows a report titled "Regional Totals by Category Sales Report". It contains a table with three columns: "Region", "Category", and "Dollar Sales". The data rows show Midwest sales for Coffee, Food, and Gifts. A shaded row at the bottom shows the total sales for the Midwest region.

Region	Category	Dollar Sales
Midwest	Coffee	\$ 4,178,513
Midwest	Food	4,338,271
Midwest	Gifts	2,883,881
Total sales: Midwest		\$ 11,400,665

When the request is run, hovering the mouse over the image displays the descriptive text. This text is read by accessibility tools, such as JAWS.

Describing Drill Down Information

When ACCESSPDF is enabled, the developer can provide a description of the Drill Down using the ALT attribute in a WebFOCUS StyleSheet. In the PDF report, JAWS will read the value of the Drill Down component along with the ALT text.

Including a description of the detail component of a Drill Down report supports accessibility.

Add Descriptive Drill Down Information

```
ALT='description'
```

where:

description

Is the description of the Drill Down information in a report, enclosed in single quotation marks ('). The length can be a maximum of 256 characters.

For details on the StyleSheet syntax for Drill Down reports, see [cr11_Linking117.htm#dcr11_Linking1012966](#).

```
TABLE FILE GGSales
SUM
  DOLLARS/D12N
BY REGION
BY CATEGORY
ON REGION SUBTOTAL AS 'Total sales: '
HEADING
" "
ON TABLE SET ACCESSPDF 508
ON TABLE SET PAGE-NUM OFF
ON TABLE NOTOTAL
ON TABLE SUBHEAD "Sales Report"
ON TABLE PCHOLD FORMAT PDF
ON TABLE SET STYLE *
  UNITS=IN,
  SQUEEZE=ON,
  ORIENTATION=PORTRAIT,
  SUMMARY='508 Sales report example',
  TITLETEXT='508 Sales report example',
$
TYPE=REPORT, GRID=OFF, FONT='ARIAL', SIZE=9,$
TYPE=DATA, COLUMN=N2,
ALT='Drill Down to detail report.', \
  FOCEXEC=508drill01detail( REGION=N1 CATEGORY=N2 ),$
TYPE=TITLE, STYLE=BOLD,$
TYPE=TABHEADING, SIZE=12, STYLE=BOLD, JUSTIFY=CENTER,$
TYPE=HEADING, SIZE=12, STYLE=BOLD, JUSTIFY=CENTER,$
TYPE=SUBTOTAL, BACKCOLOR=RGB(210 210 210), STYLE=BOLD,$
ENDSTYLE
END
```

Note the ALT attribute and associated text in BOLD.

The report is:

Sales Report		
Region	Category	Dollar Sales
Midwest	Coffee	\$ 4,178,513
Midwest	Food	4,338,271
Midwest	Gifts	
Total sales: Midwest		\$ 11,400,665
Northeast	Coffee	4,164,017
Northeast	Food	4,379,994
Northeast	Gifts	2,848,289
Total sales: Northeast		\$ 11,392,300
Southeast	Coffee	4,415,408
Southeast	Food	4,308,731
Southeast	Gifts	2,986,240
Total sales: Southeast		\$ 11,710,379
West	Coffee	4,473,517
West	Food	4,202,337
West	Gifts	2,977,092
Total sales: West		\$ 11,652,946

When you hover the mouse over Coffee for the Midwest region, the URL information for the Drill Down appears in the box. Screen readers, such as JAWS, will not read hover text. With ACCESSPDF enabled, the ALT text or 'Drill Down to detail report' is appended to the value for the Drill Down or 'Coffee' in this example. When you navigate to Coffee, the screen reader will respond with Coffee Drill Down to detail report.

i Note:

- Users that use screen readers, such as JAWS, may need more information regarding the Drill Down link. In the above example, notice that there are multiple hyperlinks for the value Coffee. This functionality, along with the 'read current cell' command, allows the user to understand the difference in those values. The screen reader command to 'read current cell' in JAWS is the Ctrl+Alt+Num5 shortcut. In this example, JAWS would respond to the 'read current cell' command with column two, row two, region Midwest, link Coffee Drill Down to detail report.
- If you are opening the output in Adobe Reader, make sure you specify the FOCExURL setting to provide the URL context of the WebFOCUS environment the Drill Down is to call back to. In addition, the FOCExURL value has to have the parameter to specify that the request is a Drill Down request. For example:

```
-SET &FOCExURL='http://host:port/ibi_apps/WFServlet?IBIF_
webapp=
  /ibi_apps' | '&';
-SET &FOCExURL=&FOCExURL | 'IBIMR_drill=IBFS,RUNFEX,IBIF_
ex,true' | '&';
-SET &FOCExURL=&FOCExURL | 'IBIC_server=EDASERVE' | '&';
-SET &FOCExURL=&FOCExURL | 'IBIAPP_app=ibisamp' | '&';
SET FOCExURL='&FOCExURL'
```

Accessibility Limitations

Reports using the following elements are not accessible:

- If a procedure does not contain the SET PAGE-NUM=OFF or ON TABLE SET PAGE-NUM OFF command, the page number will be announced two times by the screen reader.
- ACROSS and OVER reports.
- Financial Modeling Language (FML).
- **FOLD-LINE.** Accessibility is disabled when FOLD-LINE is used in a report.
- **Fixed monetary edit options (N, !d, !e, !l and !y) including the Credit Negative (CR).** A unique cell is created for the noted monetary options or CR option.

- Text included or designed in FOOTING, SUBHEAD, SUBFOOT, RECAP, SUMMARIZE, and RECOMPUTE commands do not generate row header tags.

Specifying the Main Document Heading

In a single standalone report (non-compound document), the first ON TABLE SUBHEAD string is automatically tagged as <H1>. Other page headings and footings, as many as there are available, are tagged as <H2>.

In a compound report, the DisplayOn=DOC-HEADING attribute should be added to a single fixed-positioned component that will contain the ON TABLE SUBHEAD string. The DOC-HEADING attribute indicates that the ON TABLE SUBHEAD string entered in the fixed-positioned component will be tagged as <H1> and represent the main document heading, which will be displayed once on the first physical page of the document. Other page headings and footings, as many as there are available, are tagged as <H2>.

Specifying the Main Document Heading

In the following request, the *report0* component uses the *DisplayOn=DOC-HEADING* attribute to indicate that the ON TABLE SUBHEAD string from the report0 component should be tagged as the main document heading in the PDF output.

```
SET ACCESSPDF=508
COMPOUND LAYOUT PCHOLD FORMAT PDF
OBJECT=BOOKMARKS , $
SECTION =S1, LAYOUT=ON, MERGE=OFF, ORIENTATION=PORTRAIT , $
PAGELAYOUT=1 , $
COMPONENT=report0, position=(1 0.5), Dimension=(* *),
DisplayOn=DOC-HEADING
, $
COMPONENT=report1, TEXT='Sales by Category Report',
TOC-LEVEL=1, BYTOC=2, POSITION=(1 1), DIMENSION=(* *) , $
COMPONENT=report2, TEXT='Sales by Region Report',
TOC-LEVEL=1, BYTOC=2,
POSITION=(+0.0 +0.519), DIMENSION=(* *), RELATIVE-T0='report1',
REQUIRED-SPACE=(* 3.5), RELATIVE-POINT=BOTTOM-LEFT,
POSITION-POINT=TOP-LEFT , $
END
```

```
SET COMPONENT=report0
TABLE FILE GGSALES
BY CATEGORY NOPRINT
ON TABLE SUBHEAD
" "
"DOLLAR SALES REPORT"
" "
" "
ON TABLE SET PAGE-NUM OFF
ON TABLE HOLD FORMAT PDF
ON TABLE SET STYLE *
TYPE=TABHEADING , SIZE=18, FONT=ARIAL, STYLE=BOLD, JUSTIFY=CENTER , $
ENDSTYLE
END
```

```
SET COMPONENT=report1
TABLE FILE GGSALES
SUM DOLLARS/F8M
BY CATEGORY
BY PRODUCT
BY REGION
BY ST
WHERE CATEGORY NE 'Coffee';
ON CATEGORY PAGE-BREAK
ON CATEGORY SUBTOTAL AS 'Subtotal for: '
HEADING
" "
" "
"Sales by Category"
" "
ON TABLE HOLD FORMAT PDF
ON TABLE SET PAGE-NUM OFF
ON TABLE NOTOTAL
ON TABLE SET STYLE *
TYPE=REPORT, SIZE=10, FONT=ARIAL , $
TYPE=HEADING, SIZE=14, FONT=ARIAL, STYLE=BOLD, JUSTIFY=CENTER , $
TYPE=SUBTOTAL, SIZE=10, STYLE=BOLD , $
ENDSTYLE
END
```

```
SET COMPONENT=report2
TABLE FILE GGSALES
SUM DOLLARS/F8M
BY REGION
BY ST
BY CATEGORY
```

```

BY PRODUCT
ON REGION SUBTOTAL AS 'Subtotal for: '
ON REGION PAGE-BREAK
HEADING
"Sales by Region"
" "
ON TABLE HOLD FORMAT PDF
ON TABLE SET PAGE-NUM OFF
ON TABLE NOTOTAL
ON TABLE SET STYLE *
TYPE=REPORT, SIZE=10, FONT=ARIAL , $
TYPE=HEADING, SIZE=14, FONT=ARIAL, STYLE=BOLD, JUSTIFY=CENTER , $
TYPE=SUBTOTAL, SIZE=10, STYLE=BOLD , $
ENDSTYLE
END
COMPOUND END
    
```

The first three pages of the PDF output is shown in the following images. Note that only the first page of output contains the <H1> heading, DOLLAR SALES REPORT. The other headings are tagged as <H2>.

Page 1

The screenshot shows a report viewer interface. On the left is a 'Tags' pane with a tree view containing the following structure:

- <sect>
 - <H1> DOLLAR SALES REPORT
 - <H2> Sales by Category
 - <Table>
 - <H2>
 - <Table>
 - <H2>
 - Sales by Region
 - <Table>
 - <H2>
 - <Table>
 - <H2>
 - <Table>
 - <H2>
 - <Table>

The main report area displays the following table:

DOLLAR SALES REPORT				
Sales by Category				
Category	Product	Region	State	Dollar Sales
Food	Biscotti	Midwest	IL	\$378,412
Food	Biscotti	Midwest	MO	\$368,077
Food	Biscotti	Midwest	TX	\$345,238
Food	Biscotti	Northeast	CT	\$589,355
Food	Biscotti	Northeast	MA	\$570,391
Food	Biscotti	Northeast	NY	\$642,259
Food	Biscotti	Southeast	FL	\$511,597
Food	Biscotti	Southeast	GA	\$555,231
Food	Biscotti	Southeast	TN	\$438,889
Food	Biscotti	West	CA	\$535,548
Food	Biscotti	West	WA	\$328,320
Food	Croissant	Midwest	IL	\$549,366
Food	Croissant	Midwest	MO	\$613,871
Food	Croissant	Midwest	TX	\$597,887
Food	Croissant	Northeast	CT	\$551,489
Food	Croissant	Northeast	MA	\$497,234
Food	Croissant	Northeast	NY	\$622,095
Food	Croissant	Southeast	FL	\$602,076
Food	Croissant	Southeast	GA	\$661,806
Food	Croissant	Southeast	TN	\$636,477
Food	Croissant	West	CA	\$1,524,541
Food	Croissant	West	WA	\$801,060
Food	Scone	Midwest	IL	\$595,069
Food	Scone	Midwest	MO	\$481,953
Food	Scone	Midwest	TX	\$418,398
Food	Scone	Northeast	CT	\$283,874
Food	Scone	Northeast	MA	\$332,486
Food	Scone	Northeast	NY	\$260,811
Food	Scone	Southeast	FL	\$311,836
Food	Scone	Southeast	GA	\$273,420
Food	Scone	Southeast	TN	\$315,399
Food	Scone	West	CA	\$608,423
Food	Scone	West	WA	\$304,445
Subtotal for: Food				\$17,229,332

Page 2

Category	Product	Region	State	Dollar Sales
Gifts	Coffee Grinder	Midwest	IL	\$233,292
Gifts	Coffee Grinder	Midwest	MO	\$181,570
Gifts	Coffee Grinder	Midwest	TX	\$204,292
Gifts	Coffee Grinder	Northeast	CT	\$169,908
Gifts	Coffee Grinder	Northeast	MA	\$177,940
Gifts	Coffee Grinder	Northeast	NY	\$161,352
Gifts	Coffee Grinder	Southeast	FL	\$217,204
Gifts	Coffee Grinder	Southeast	GA	\$217,254
Gifts	Coffee Grinder	Southeast	TN	\$171,319
Gifts	Coffee Grinder	West	CA	\$401,680
Gifts	Coffee Grinder	West	WA	\$201,756
Gifts	Coffee Pot	Midwest	IL	\$204,828
Gifts	Coffee Pot	Midwest	MO	\$190,153
Gifts	Coffee Pot	Midwest	TX	\$204,897
Gifts	Coffee Pot	Northeast	CT	\$208,209
Gifts	Coffee Pot	Northeast	MA	\$184,119
Gifts	Coffee Pot	Northeast	NY	\$198,452
Gifts	Coffee Pot	Southeast	FL	\$212,057
Gifts	Coffee Pot	Southeast	GA	\$232,552
Gifts	Coffee Pot	Southeast	TN	\$200,684
Gifts	Coffee Pot	West	CA	\$400,130
Gifts	Coffee Pot	West	WA	\$213,494
Gifts	Mug	Midwest	IL	\$376,754
Gifts	Mug	Midwest	MO	\$343,852
Gifts	Mug	Midwest	TX	\$366,337
Gifts	Mug	Northeast	CT	\$392,967
Gifts	Mug	Northeast	MA	\$401,944
Gifts	Mug	Northeast	NY	\$349,300
Gifts	Mug	Southeast	FL	\$409,466
Gifts	Mug	Southeast	GA	\$355,447
Gifts	Mug	Southeast	TN	\$337,790
Gifts	Mug	West	CA	\$761,325
Gifts	Mug	West	WA	\$427,339
Gifts	Thermos	Midwest	IL	\$187,901
Gifts	Thermos	Midwest	MO	\$195,686
Gifts	Thermos	Midwest	TX	\$194,319
Gifts	Thermos	Northeast	CT	\$221,827
Gifts	Thermos	Northeast	MA	\$203,435
Gifts	Thermos	Northeast	NY	\$178,836
Gifts	Thermos	Southeast	FL	\$195,526
Gifts	Thermos	Southeast	GA	\$227,482
Gifts	Thermos	Southeast	TN	\$209,449
Gifts	Thermos	West	CA	\$372,728
Gifts	Thermos	West	WA	\$196,640
Subtotal for: Gifts				\$11,695,502

Page 3

Region	State	Category	Product	Dollar Sales
Midwest	IL	Coffee	Espresso	\$420,439
Midwest	IL	Coffee	Latte	\$978,340
Midwest	IL	Food	Biscotti	\$378,412
Midwest	IL	Food	Croissant	\$549,366
Midwest	IL	Food	Scone	\$595,069
Midwest	IL	Gifts	Coffee Grinder	\$233,292
Midwest	IL	Gifts	Coffee Pot	\$204,828
Midwest	IL	Gifts	Mug	\$376,754
Midwest	IL	Gifts	Thermos	\$187,901
Midwest	MO	Coffee	Espresso	\$419,143
Midwest	MO	Coffee	Latte	\$968,981
Midwest	MO	Food	Biscotti	\$368,077
Midwest	MO	Food	Croissant	\$613,871
Midwest	MO	Food	Scone	\$481,953
Midwest	MO	Gifts	Coffee Grinder	\$181,570
Midwest	MO	Gifts	Coffee Pot	\$190,153
Midwest	MO	Gifts	Mug	\$343,852
Midwest	MO	Gifts	Thermos	\$195,686
Midwest	TX	Coffee	Espresso	\$455,365
Midwest	TX	Coffee	Latte	\$938,245
Midwest	TX	Food	Biscotti	\$345,238
Midwest	TX	Food	Croissant	\$587,887
Midwest	TX	Food	Scone	\$418,398
Midwest	TX	Gifts	Coffee Grinder	\$204,292
Midwest	TX	Gifts	Coffee Pot	\$204,897
Midwest	TX	Gifts	Mug	\$366,337
Midwest	TX	Gifts	Thermos	\$194,319
Subtotal for: Midwest				\$11,400,665

50

Using PostScript (PS) Display Format

You can display a report as a PostScript document. PostScript (format PS) is a print-oriented page description language. As a display format, it may be helpful if you wish to see the report output on your monitor before printing it using PostScript.

To display a PostScript report, a computer must have a third-party PostScript application installed, such as GSview (a graphical interface for Ghostscript).

If you are sending a PS report to a printer from FOCUS, you can select the size of the paper on which to print the output. The PostScript code that is generated works on PS printers that support Language Level 2 or above. It is ignored, without harmful effects, on Level 1 printers. This capability is only supported for the PostScript format.

Other print-oriented display formats. You can also display a report as a PDF document. For more information, see [Using PDF Display Format](#).

Select Paper Size in a PostScript (PS) Report

PAGESIZE and ORIENTATION are two WebFOCUS StyleSheet options that are used to display a report. You can enable these features in printed documents using the SET parameter PSPAGESETUP. You can then select the size of the paper on which to print a PostScript report by selecting a PAGESIZE option.

Complete these steps:

Procedure

1. Place the following SET parameter before or within your request

```
SET PSPAGESETUP= ON
```

or

```
ON TABLE SET PSPAGESETUP ON
```

OFF is the default setting.

2. Include your PAGESIZE specification in a SET command or StyleSheet declaration in the request

```
SET PAGESIZE= option
```

or

```
ON TABLE SET PAGESIZE option
```

or

```
PAGESIZE=option, $
```

where:

option

Can be any paper size supported for your printer. LETTER is the default setting.

Result

i Note: If you send a job to a printer that does not have the requested paper size loaded, the printer may stop and instruct its operator to load the specified paper. To ensure control over your printing, it is best to set paper size in individual requests (rather than as an installation-wide default) so that you can load paper as required.

Selecting Paper Size Using SET Command in a PostScript Report

This example automatically prints a document on legal paper as specified in the two SET commands that precede the report request. The referenced printer is a PostScript Level 2 or higher printer, which will automatically select legal paper and print the document in landscape mode.

```
SET PSPAGESETUP=ON
SET PAGESIZE=LEGAL
SET ORIENTATION=LANDSCAPE
SET PAGE-NUM=OFF
TABLE FILE CENTORD
HEADING
"Sales Report"
" "
SUM LINEPRICE
BY PRODCAT
ON TABLE SET STYLE *
TYPE=HEADING, SIZE=18, $
ENDSTYLE
```

```
ON TABLE HOLD FORMAT PS
END
```

```
-RUN
DOS COPY HOLD.PS \\IBIPRINTA\28C2
```

Selecting Paper Size Using a SET Command and a StyleSheet

This request automatically prints a document on legal paper based on the paper size and orientation specifications in the StyleSheet declaration. The referenced printer is a PostScript Level 2 or higher printer, which will automatically select legal paper and print the document in landscape mode.

```
SET PSPAGESETUP=ON
TABLE FILE CAR
SUM RC DC SALES BY COUNTRY BY CAR BY MODEL
ON TABLE HOLD FORMAT PS
ON TABLE SET STYLE *
UNITS=IN,
    PAGESIZE='Legal',
    LEFTMARGIN=1.000000,
    RIGHTMARGIN=0.500000,
    TOPMARGIN=1.500000,
    BOTTOMMARGIN=0.500000,
    SQUEEZE=ON,
    ORIENTATION=LANDSCAPE,$
GRAPHTYPE=DATA, COLUMN=RC, GRAPHPATTERN=EMPTY, $
GRAPHTYPE=DATA, COLUMN=DC, GRAPHPATTERN=SLANT, $
GRAPHTYPE=DATA, COLUMN=SALES,
GRAPHPATTERN=HORIZONTAL, $
ENDSTYLE
END
-RUN
DOS COPY HOLD.PS \\IBIPRINTA\28C2
```

FOCUS Font Support

You can add and configure PostScript Type 1 fonts to significantly expand your options for displaying and printing PS and PDF reports, beyond those provided by the basic set of fonts distributed with Adobe Reader. Thousands of PostScript fonts are available to make your reports more stylish and useful, including some that support symbols and bar codes.

The font map files for Type 1 fonts are stored as XML files (fontmap.xml and fontuser.xml). All font mappings in these files are used for both PDF and PostScript report output.

The font definitions for DHTML also cover PowerPoint (PPT and PPTX). For XLSX, you can define a new default font in the fontuser.xml file. This allows ease in customizing the look and feel of XLSX workbooks. FOCUS uses Arial as the default font. However, you can change the default font to match the Microsoft Office standard font, Calibri, or your corporate standard.

Support for the Symbol Font

To use the Symbol font, specify font=symbol in your FOCUS StyleSheet:

- Some versions of Firefox 3 do not support the Symbol font and will substitute it with another font. For information about Firefox support for the Symbol font, refer to Firefox sources.
- The Euro character displays in PDF output because the Adobe Symbol character set includes the Euro character.
- The Euro character does not display in DHTML, PPT, and PPTX report output because the Windows Symbol character set does not include the Euro character.
- The following style options can be rendered with the Symbol font:
 - DHTML, PPT, and PPTX support style=normal, bold, italic, and bold+italic.
 - PDF supports only style=normal. Any other style specified in the StyleSheet will be mapped to normal.

How FOCUS Uses Type 1 Fonts

FOCUS generates a PDF or PS document from scratch. In order to do that, it must physically embed all the objects it displays or prints, including images and fonts, in the document itself.

When you execute a report and specify one of these formats as your display format, FOCUS retrieves the data and begins to format the report. Fonts and images specified in the StyleSheet must be available to FOCUS to create the output file. It reads the font

information from the font files and embeds that information into the document. The font itself is stored in a data set allocated in your FOCUS JCL or CLIST.

To ensure that FOCUS can locate the required information, you must define and map it in the following files:

- **Font file, usually a PFB (Printer Font Binary) file.** This file contains the information about the shape to draw for each character of the font. The information in the font file is scalable, which means that a single font file can be used to generate characters of any size. Note, however, that bold and italic variations of the typeface are separate fonts. An alternative ASCII format, PFA, can also be used by FOCUS.
- **Adobe Font Metrics (AFM) file.** This file is distributed with all Adobe fonts. It contains information about the size of each character in each font. FOCUS uses this information to lay out the report on the page. Note that the three built-in fonts also have AFM files, which are distributed with FOCUS. However, these fonts do not require font files, since the fonts are built in to Adobe Reader.

i Note: A Printer Font Metrics (PFM) file is also available. This file is used by applications such as Adobe Reader for laying out text, however it is not supported by FOCUS. You must use the AFM file.

- **FOCUS Font Map Files.** These configuration files map the name of a font to the appropriate font metrics and font files (AFM and PFB or PFA). The mapping determines which actual font is used when you specify a font using the FONT attribute in a FOCUS StyleSheet. For example, if your StyleSheet contains the following declaration, FOCUS will search the font map for a font mapping with a matching name and style, and use the font specified by the mapping:

```
TYPE=REPORT, FONT=HELVETICA, STYLE=ITALIC, $
```

There are two files FOCUS uses for mapping fonts, both in an XML-based format:

- The default font map file, *fontmap.xml*, contains the font definitions for all output formats that are supported with FOCUS, as originally installed. Users should not modify this file.
- The user font map file, *fontuser.xml*, contains font definitions added by the user. The following sections describe how to add your fonts to this file.

The user font map should be in a data set concatenated in front of the distributed ERRORS libraries so it is searched before the default font map. Then font definitions in the user map will override definitions of the same font in the default map.

You can also use a variety of utilities to convert Windows True Type fonts (such as Arial and Tahoma) into Type 1 fonts. Then, after you convert them, you can define and map these fonts for use by FOCUS.

One such utility is TTF2PT1.

For information about the Windows version, go to:

<http://gnuwin32.sourceforge.net/packages/ttf2pt1.htm>

Adding PostScript Type 1 Fonts for PS and PDF Formats

This section describes how to add PostScript type 1 fonts to the *fontuser.xml* file.

Configure Type 1 PostScript Fonts on the Windows and UNIX Platforms

Locate the necessary font files (AFM and PFB or PFA). These files should be available in the location where the fonts were originally installed. You will be copying these files to a location from which they can be accessed by FOCUS.

**Tip:**

- You may need to run an installer program to install these in a directory on your Windows or UNIX machine. Note that the fonts do not have to be installed on a client machine in order to be used, since they will be embedded in the PDF or PostScript files created by FOCUS. PDF files with these embedded fonts can be displayed on any machine that has Adobe Reader (or a similar PDF viewer), and PostScript files with these embedded fonts can be printed on any PostScript printer (or displayed in a PostScript viewer such as GhostView).
- Note that PFB files are binary, so if they are FTPed from another machine, they must be FTPed in BINARY mode.
- The maximum number of embedded fonts supported in a PDF report is 63.

After you have located the font files you wish to add, you can set up FOCUS to use one or more Type 1 fonts.

Procedure

1. For each font you wish to add, copy the AFM and PFB (or PFA) files into the **etc** subdirectory of your FOCUS configuration directory. On a Windows machine, the location is usually:

```
drive:\ibi\srv82\foc\etc
```

where:

foc

Is your FOCUS configuration directory (it may have a different name depending on installation options, but should always be a directory directly under *drive:\ibi\srv82*). Note that *home* is the other directory directly under *drive:\ibi\srv82*.

Under Unix, the location is */ibi/srv82/foc/etc*, assuming that FOCUS was installed in */ibi/srv82*.

Keeping user font files in this directory allows user font files to remain separate from the default font files (under *\ibi\srv82\home*) so they can be easily preserved if FOCUS is updated to a new release.

After you copy these files, you can rename them to any descriptive name.

2. The user font map file, *fontuser.xml*, is created by the installer in the same directory. Using a text editor, add your font definitions to this file using the syntax described in the following section, [Add Fonts to the Font Map](#).

Configure Type 1 PostScript Fonts on z/OS

After you have located the font files you wish to add, you can configure FOCUS to use one or more Type 1 fonts.

Procedure

1. Copy the AFM (font metrics) file into the PDS allocated to DDNAME ERRORS in the FOCUS JCL or CLIST. You can copy this file from another machine using FTP in standard ASCII (text) mode. The member name of the AFM file in this PDS will match the *metricsfile* value in the font map file.

i Note: If the Windows font file names contain underscore characters or are longer than eight characters, you must rename them, since these are not valid for z/OS member names.

2. You can use either PFB (binary) fonts or PFA (ASCII) fonts:
 - If you are using PFB (binary) fonts, create a partitioned data set, put the PFB file in it (for example, using FTP in BINARY mode), and allocate this data set to DDNAME PFB.

This PDS should be created with the following DCB attributes:

```
RECFM: VB      LRECL: 1028      BLKSIZE: 27998
```

The member name in this PDS should match the *fontfile* name in the font map file.

If you copy the PFB font file into the PDS using FTP, you must use BINARY mode. The member name of the PFB file in this PDS will match the *fontfile* value in the font map file.

- If you are using PFA (ASCII) font files, create a PDS (separate from the one you

use for PFB fonts), put the PFA file in it (for example, using FTP in regular, ASCII mode), and allocate this data set to DDNAME PFA. This PDS should be created with the following DCB attributes:

```
RECFM: VB      LRECL: 2044      BLKSIZE: 27998
```

The member name in this PDS should match the *fontfile* value in the font map file. Note that you can use PFB and PFA files simultaneously. The *fonttype* attribute in the font map file (PFB or PFA) tells FOCUS which PDS to search for the specified member name.

3. The user font map file is in member FONTUSER in a data set allocated to DDNAME ERRORS. Using a text editor, add your font definition to the user font map using the syntax described in [Add Fonts to the Font Map](#).

Add Fonts to the Font Map

The Type 1 PostScript fonts used with the PostScript and PDF output formats use separate font files for each variant of the font: normal, bold, italic, and bold-italic. This grouping of related fonts is called a *font family*.

The XML font map syntax uses two XML tags, *<family>* and **, to represent this structure. The example uses the family name *Garamond*. For example:

```
<family name="garamond">
  <font style="normal"
    metricsfile="gdrg" fontfile="gdrg" fonttype="PFB" />
  <font style="bold"
    metricsfile="gdb" fontfile="gdb" fonttype="PFB" />
  <font style="italic"
    metricsfile="gdi" fontfile="gdi" fonttype="PFB" />
  <font style="bold+italic"
    metricsfile="gdbi" fontfile="gdbi" fonttype="PFB" />
</family>
```

The following example uses the family name *otf*. For example:

```
<family name="otf">
  <font style="normal"
    metricsfile="otfn" fontfile="otfn" fonttype="OTF" />
```



```

<font style="bold"
      metricsfile="otfb" fontfile="otfb" fonttype="OTF" />
<font style="italic"
      metricsfile="otfi" fontfile="otfi" fonttype="OTF" />
<font style="bold+italic"
      metricsfile="otfbi" fontfile="otfbi" fonttype="OTF" />
</family>

```

The basics of the XML syntax are:

- Tag names (such as *family* and *font*) and attribute names (such as *style* or *metricsfile*) must be in lowercase. Attribute values, such as font file names, are case-insensitive.
- Attribute values, which is the text after the equal sign (=), must be in double quotation marks (for example, "*bold*")
- Elements that have no explicit end-tag must end with `/>`. (For example, the family tag has the closing tag `</family>`, but the font tag has no closing tag, so it ends with `/>`.)
- Comments are enclosed in special delimiters:

```
<!-- This is a comment -->
```

- Line breaks may be placed between attribute-value pairs.

A more complete description of XML syntax can be found here:

<http://en.wikipedia.org/wiki/Xml>

The family element

The *family* element specifies the name of a font family. This family name, specified in the *name* attribute of the family element, is the name by which the font will be referenced in a StyleSheet. It corresponds to the value of the FONT attribute in the StyleSheet. The end-tag `</family>` closes the family element, and any number of additional family elements may follow.

Font family names should be composed of letters (A-Z, a-z), digits, and limited special characters, such as a minus sign (-), underscore (_), and blank. Font family names should have a maximum length of 40 characters. Since the font name is only a reference to a mapping in the font map, it does not need to be related to the actual name of the font (which FOCUS obtains from the mapped AFM file) or the file name of the font.

Font elements

Nested within each *family* element are one or more *font* elements that specify the font files for each font in the family. For example, there may be one font element for the font *Garamond Regular* (normal), one for *Garamond Italic* (italic). Since a font element has no child elements, it is closed with `</>`.

The actual name of the font as used in the PDF or PostScript document is taken from the font metric file.

Fonts defined in the user font file (`fontuser.xml`) can override default font definitions in `fontmap.xml`. Thus, you should be careful to choose family names that do not conflict with existing definitions, unless you actually wish to override these definitions (which should generally not be done).

Each font element contains the following attributes:

- **style:** This attribute specifies the style of the font and corresponds to the `STYLE` attribute in the StyleSheet. The allowed values are "normal", "bold", "italic", and "bold+italic". For example, the font defined in the following bold italic font element:

```
<font style="bold+italic" metricsfile="gdbi" fontfile="gdbi"
fonttype="PFB" />
```

could be referenced in the StyleSheet like this:

```
TYPE=REPORT, FONT=GARAMOND, STYLE=BOLD+ITALIC, $
```

Although most fonts have a font file for each of the four styles, some specialized fonts such as bar code fonts might only have a single style (usually "normal"). Only the styles that exist for a particular font need to be specified in the font map file.

The actual names of the fonts may vary. Some fonts may be called "oblique" rather than "italic", or "heavy" rather than "bold". However, the font map and StyleSheet always use the keywords "normal", "bold", "italic" and "bold+italic".

- **metricsfile:** This attribute specifies the name of the Adobe Font Metrics (AFM) file that provides the measurements of the font. You should only use the base name of the file (for example, "gdr", not "gdr.afm"). On z/OS, the name refers to a member in a PDS allocated to `ERRORS`. For information about file locations, see [Configure Type 1 PostScript Fonts on z/OS Under PDS Deployment](#).

File names should be composed of letters and numbers, and should not contain blanks.

- **fonttype:** This attribute specifies the type of the font file. The allowed values are

"PFA" or "PFB".

- **fontfile:** This attribute specifies the name of the PFB or PFA file that contains the font itself. As with *metricsfile*, the value specifies only the base file name (the *fonttype* attribute specifies the type). On Windows and UNIX, the file is assumed to have the extension *.pfb* for binary (PFB) font files or *.pfa* for ASCII (PFA) font files, and should reside in the same directory as the AFM files (*wfs/etc*). On z/OS the name refers to a member in the appropriate PDS.

Additional items of XML syntax include the XML header on the first line of the file and the `<fontmap>` and `<when>` elements that enclose all of the family elements. The `<when>` tag allows the same font mappings to be used for both PDF and PostScript reports across output formats. These can include PDF, PS, and DHTML. PPT and PPTX formats will use fonts specified for DHTML. If no `<when>` is specified, the font will be available for all formats.

The following is a complete example of a user font map:

```
<?xml version="1.0" encoding="UTF-8" ?>
<!-- Example of a user font map file with two font families. -->
<fontmap version="1">
  <when format="PDF PS">
    <family name="garamond">
      <font style="normal"
        metricsfile="gdrg" fontfile="gdrg" fonttype="PFB" />
      <font style="bold"
        metricsfile="gdb" fontfile="gdb" fonttype="PFB" />
      <font style="italic"
        metricsfile="gdi" fontfile="gdi" fonttype="PFB" />
      <font style="bold+italic"
        metricsfile="gdbi" fontfile="gdbi" fonttype="PFB" />
    </family>
    <!-- This font only has a "normal" style, others omitted. -->
    <family name="ocra">
      <font style="normal"
        metricsfile="ocra" fontfile="ocra" fonttype="PFB" />
    </family>
  </when>
</fontmap>
```

FOCUS StyleSheet Declaration

Once the font map files have been set up, the newly mapped fonts can be used in a FOCUS StyleSheet. For example, to use the Garamond fonts:

```
ON TABLE SET STYLE *  
  type=report, font=garamond, size=12, $  
  type=title, font=garamond, style=bold, color=blue, $  
ENDSTYLE
```

Since the *style* attribute has been omitted for the report font in the StyleSheet, it defaults to normal. Attributes such as *size* and *color* can also be applied.

Editing the Font Map File

There is a byte order mark (BOM) at the beginning of the user font map file (fontuser.xml), which must be preserved for this file to be read correctly.

If you are using a Unicode-aware editor, such as Notepad on Windows, to edit the file, the BOM will not be visible, but you can preserve it by making sure that you select an encoding of UTF-8 in the Save-As dialog. In most other editors, such as the ISPF editor under z/OS, the BOM will display as three or four strange-looking characters at the beginning of the file. As long as you do not delete or modify these characters, the BOM will be preserved.

The FOCUS Default Font Map

Since the user font map is searched before the FOCUS default font map, font definitions in the user font map file will override mappings of the same font in the default font map file. Since you usually would not want to override existing font mappings, you can check which font names are already used by FOCUS by examining the default font map file.

On z/OS, it is in the FONTMAP member of a partitioned data set allocated to DDNAME ERRORS. Unlike the user font map file, this file has separate sections containing definitions for PS, PDF, and DHTML formats.

i Note: The DHTML mappings are used for the DHTML and PowerPoint output formats, which do not support user-added fonts.

Since the font mappings in the default font map file are for fonts that are already assumed to exist on the user machines (for example, built-in Adobe Reader fonts, standard PostScript printer fonts, or standard Windows fonts), they do not reference font files, only font metrics files. Fonts provided by the user should reference both font files and metrics files.

AFM files for the default fonts are also members of a data set allocated to DDNAME ERRORS.

Define a Default Font in the Font Map

An individual default font can be set for each output type and/or language setting within an output type. This setting should be defined in the fontuser.xml file rather than the fontmap.xml file. Fontmap.xml may be updated by a future release installation, so customizations may be lost. Additionally, the settings in fontuser.xml override settings in fontmap.xml.

On z/OS, the fontmap and fontuser xml files are members of FONTMAP and FONTUSER in a data set allocated to DDNAME ERRORS.

To designate the default font use the following steps:

Procedure

1. Copy the selected font entry from fontmap.xml to fontuser.xml.
 - a. Within fontmap.xml, find the entry for the font family within the desired output format to be designated as the default.
 - b. Copy the entire entry into the appropriate format area within fontuser.xml.
2. In fontuser.xml, within the entry for the font to be designated as the default font and style, add the following attribute:

```
default="yes"
```

For example, the following code defines the default fonts to be Helvetica bold for

PDF, Calibri for XLSX, and Arial Italic for DHTML:

```

<fontmap version="1">
  <when format="PDF PS">
    <family name="Helvetica" htmlfont="Arial">
      <font style="normal" metricsfile="pdhelv" />
      <font style="bold" metricsfile="pdhelvb" default="yes" />
      <font style="italic" metricsfile="pdhelvi" />
      <font style="bold+italic" metricsfile="pdhelvbi" />
    </family>
  </when>
  <when format="XLSX">
    <family name="Calibri" htmlfont="Calibri">
      <font style="normal" metricsfile="ttcali" default="yes" />
    />
      <font style="bold" metricsfile="ttcalib" />
      <font style="italic" metricsfile="ttcalii" />
      <font style="bold+italic" metricsfile="ttcalibi" />
    </family>
  </when>
  <when format="DHTML">
    <family name="Arial">
      <font style="normal" metricsfile="ttarial" />
      <font style="bold" metricsfile="ttarialb" />
      <font style="italic" metricsfile="ttariali" default="yes" />
      <font style="bold+italic" metricsfile="ttariabi" />
    </family>
  </when>
</fontmap>

```

If multiple fonts in a font map family, such as PDF, have the `default="yes"` attribute, the last font with that attribute becomes the default font. Fonts in `fontuser.xml` are processed after those in `fontmap.xml`, so a default font set in `fontuser.xml` can override the one set in `fontmap.xml`.

A default font set in the PDF section of the font map does not affect a default in the DHTML section, and a default for one specific language does not override the default for other languages.

Embedding TrueType Fonts Into WebFOCUS PDF Reports Generated in Windows

You can have WebFOCUS embed the following TrueType fonts into PDF output files generated in Windows:

- Arial Unicode MS
- Courier New
- Lucida Sans Unicode
- Tahoma
- Times New Roman
- Trebuchet MS

i Note:

- Custom TrueType font embedding is supported, as long as you provide the AFM and TTF files. Only TTF fonts that have format 4 layer with platform ID 3 and platform specific ID 1 are supported.
- The addition of the font file and font type attributes activates the embedding feature. To use any of these fonts and font styles without embedding, do not add the font file and font style attributes into the font map definition for each individual style.

Add TrueType Fonts for Embedding Into PDF Output Files

Procedure

1. Make the fonts available to the WebFOCUS Reporting Server by copying the TrueType font files from the Windows font directory (C:\Windows\fonts) to the WebFOCUS server configuration directory:

```
drive:\ibi\srv82\wfs\etc
```

where:

drive

Is the drive on which the WebFOCUS Reporting Server is installed.

wfs

Is your WebFOCUS configuration directory (it may have a different name depending on installation options, but should always be a directory directly under *drive:\ibi\srv82*). Note that **home** is the other directory directly under *drive:\ibi\srv82*.

For each of the supported fonts, you will need to copy the following font files. You will also need to know the metrics file name associated with each font file:

Arial Unicode MS

Style	Metrics File Name	Font File Name
Normal	pdarum.afm	arialuni.ttf
Bold	pdarumb.afm	arialuni.ttf
Italic	pdarumi.afm	arialuni.ttf
Bold Italic	pdarumbi.afm	arialuni.ttf

Courier New

Style	Metrics File Name	Font File Name
Normal	pdconu.afm	cour.ttf

Style	Metrics File Name	Font File Name
Bold	pdconub.afm	courbd.ttf
Italic	pdconui.afm	couri.ttf
Bold Italic	pdconubi.afm	courbi.ttf

Lucida Sans Unicode

Style	Metrics File Name	Font File Name
Normal	pdlusu.afm	l_10646.ttf
Bold	pdlusub.afm	l_10646.ttf
Italic	pdlusui.afm	l_10646.ttf
Bold Italic	pdlusubi.afm	l_10646.ttf

Tahoma

Style	Metrics File Name	Font File Name
Normal	pdtaho.afm	tahoma.ttf
Bold	pdtahob.afm	tahomabd.ttf
Italic	pdtahoi.afm	tahoma.ttf
Bold italic	pdtahobi.afm	tahomabd.ttf

Times New Roman

Style	Metrics File Name	Font File Name
Normal	pdtimu.afm	times.ttf
Bold	pdtimub.afm	timesbd.ttf
Italic	pdtimui.afm	timesi.ttf
Bold Italic	pdtimubi.afm	timesbi.ttf

Trebuchet MS

Style	Metrics File Name	Font File Name
Normal	pdtrbu.afm	trebuc.ttf
Bold	pdtrbub.afm	trebucbd.ttf
Italic	pdtrbui.afm	trebucit.ttf
Bold Italic	pdtrbubi.afm	trebucbi.ttf

2. Add the fonts to the user font map file, fontuser.xml. This file is also located in the WebFOCUS Reporting Server configuration directory **drive:\ibi\srv82\wfs\etc**.

The fontuser.xml file has a sample family tag. Copy the sample family tag between `<when format="PDF PS">` and `</when>`, then edit it for the font you are adding. For more information on editing font map syntax, see [Add Fonts to the Font Map](#).

The following shows a user font map file with the Arial Unicode MS font added:

```
<?xml version="1.0" encoding="UTF-8" ?>
<!-- Example of a user font map file defining Arial Unicode MS true
type fonts -->
```

```

<fontmap version="1">
<when format="PDF">
  <family name = "Arial Unicode MS">
    <font style="normal" metricsfile="pdarum"
      fontfile="arialuni" fonttype="TTF" />
    <font style="bold" metricsfile="pdarumb"
      fontfile="arialuni" fonttype="TTF" />
    <font style="bold+italic" metricsfile="pdarumbi"
      fontfile="arialuni" fonttype="TTF" />
    <font style="italic" metricsfile="pdarumi"
      fontfile="arialuni" fonttype="TTF" />
  </family>
</when>
</fontmap>

```

Note that the font file name does not include the extension. The extension, TTF, is entered as the fonttype attribute.

3. In a report request, specify the font family names and the style attributes in the stylesheet, and hold the report output in PDF format.

Result

An example follows of the contents of a fontuser.xml file with all of the supported embedded fonts defined. You can select only the ones you need for your environment:

```

<fontmap version="1">
  <when format="PDF PS">

```

```

    <family name = "Arial Unicode MS">
      <font style="normal"
        metricsfile="pdarum" fontfile="arialuni" fonttype="TTF" />
      <font style="bold"
        metricsfile="pdarumb" fontfile="arialuni" fonttype="TTF" />
      <font style="bold+italic"
        metricsfile="pdarumbi" fontfile="arialuni" fonttype="TTF" />
      <font style="italic"
        metricsfile="pdarumi" fontfile="arialuni" fonttype="TTF" />
    </family>

```

```

    <family name="Trebuchet MS">
      <font style="normal"
        metricsfile="pdtrbu" fontfile="trebuc" fonttype="TTF" />

```

```

<font style="bold"
  metricsfile="pdtrbub" fontfile="trebucbd" fonttype="TTF" />
<font style="italic"
  metricsfile="pdtrbui" fontfile="trebucit" fonttype="TTF" />
<font style="bold+italic"
  metricsfile="pdtrbubi" fontfile="trebucbi" fonttype="TTF" />
</family>

```

```

<family name="Times New Roman">
  <font style="normal"
    metricsfile="pdtimu" fontfile="times" fonttype="TTF" />
  <font style="bold"
    metricsfile="pdtimub" fontfile="timesbd" fonttype="TTF" />
  <font style="italic"
    metricsfile="pdtimui" fontfile="timesi" fonttype="TTF" />
  <font style="bold+italic"
    metricsfile="pdtimubi" fontfile="timesbi" fonttype="TTF" />
</family>

```

```

<family name="Lucida Sans Unicode">
  <font style="normal"
    metricsfile="pdlusu" fontfile="L_10646" fonttype="TTF" />
  <font style="bold"
    metricsfile="pdlusub" fontfile="L_10646" fonttype="TTF" />
  <font style="italic"
    metricsfile="pdlusui" fontfile="L_10646" fonttype="TTF" />
  <font style="bold+italic"
    metricsfile="pdlusubi" fontfile="L_10646" fonttype="TTF" />
</family>

```

```

<family name = "Courier New">
  <font style="normal"
    metricsfile="pdconu" fontfile="cour" fonttype="TTF" />
  <font style="bold"
    metricsfile="pdconub" fontfile="courbd" fonttype="TTF" />
  <font style="bold+italic"
    metricsfile="pdconubi" fontfile="courbi" fonttype="TTF" />
  <font style="italic"
    metricsfile="pdconui" fontfile="couri" fonttype="TTF" />
</family>

```

```

<family name = "Tahoma">
  <font style="normal"
    metricsfile="pdtaho" fontfile="tahoma" fonttype="TTF" />
  <font style="bold"
    metricsfile="pdtahob" fontfile="tahomabd" fonttype="TTF" />
  <font style="bold+italic"
    metricsfile="pdtahobi" fontfile="tahomabd" fonttype="TTF" />
  <font style="italic"
    metricsfile="pdtahoi" fontfile="tahoma" fonttype="TTF" />
</family>
</when>
</fontmap>

```

Embedding TrueType Fonts in a PDF Output File

The font files `trebuc.ttf`, `trebudbd.ttf`, `trebucit.ttf`, `trebucbi.ttf`, `tahoma.ttf`, and `tahomabd.ttf` have been copied to the WebFOCUS Reporting Server configuration directory, `drive:\ibi\srv82\wfs\etc`. In addition, the Trebuchet MS and Tahoma fonts have been added to the `fontuser.xml` file:

```

<fontmap version="1">
  <when format="PDF PS">
    <!-- family/font tags should be added here -->
    <family name="Trebuchet MS">
      <font style="normal"
        metricsfile="pdtrbu" fontfile="trebuc" fonttype="TTF" />
      <font style="bold"
        metricsfile="pdtrbub" fontfile="trebucbd" fonttype="TTF" />
      <font style="italic"
        metricsfile="pdtrbui" fontfile="trebucit" fonttype="TTF" />
      <font style="bold+italic"
        metricsfile="pdtrbubi" fontfile="trebucbi" fonttype="TTF" />
    </family>
    <family name="Tahoma">
      <font style="normal"
        metricsfile="pdtaho" fontfile="tahoma" fonttype="TTF" />
      <font style="bold"
        metricsfile="pdtahob" fontfile="tahomabd" fonttype="TTF" />
    </family>
  </when>
</fontmap>

```

The following request against the GGSALES data source specifies the Trebuchet MS font for the column headings and the bold style of Tahoma for the data in the PDF report output:

```
TABLE FILE GGSALES
SUM DOLLARS UNITS
BY REGION
ON TABLE HOLD FORMAT PDF
ON TABLE SET PAGE NOPAGE
ON TABLE SET STYLE *
TYPE = TITLE, FONT='Trebuchet MS', $
TYPE = DATA, FONT='Tahoma', style=bold, size=10, color=blue, $
END
```

The output is:

<u>Region</u>	<u>Dollar Sales</u>	<u>Unit Sales</u>
Midwest	11400665	905045
Northeast	11392300	916675
Southeast	11710379	935232
West	11652946	932039

i Note: In order to reduce the size of a generated PDF document, only the subset of used characters of a font are included into the PDF document.

To confirm that a subset of the font is embedded, save a copy of the PDF file and open it in Adobe Reader. On the File menu, select **Properties**. In the Font tab, look for the words Embedded Subset next to the font name, as shown in the following image for the Tahoma and Trebuchet MS fonts.

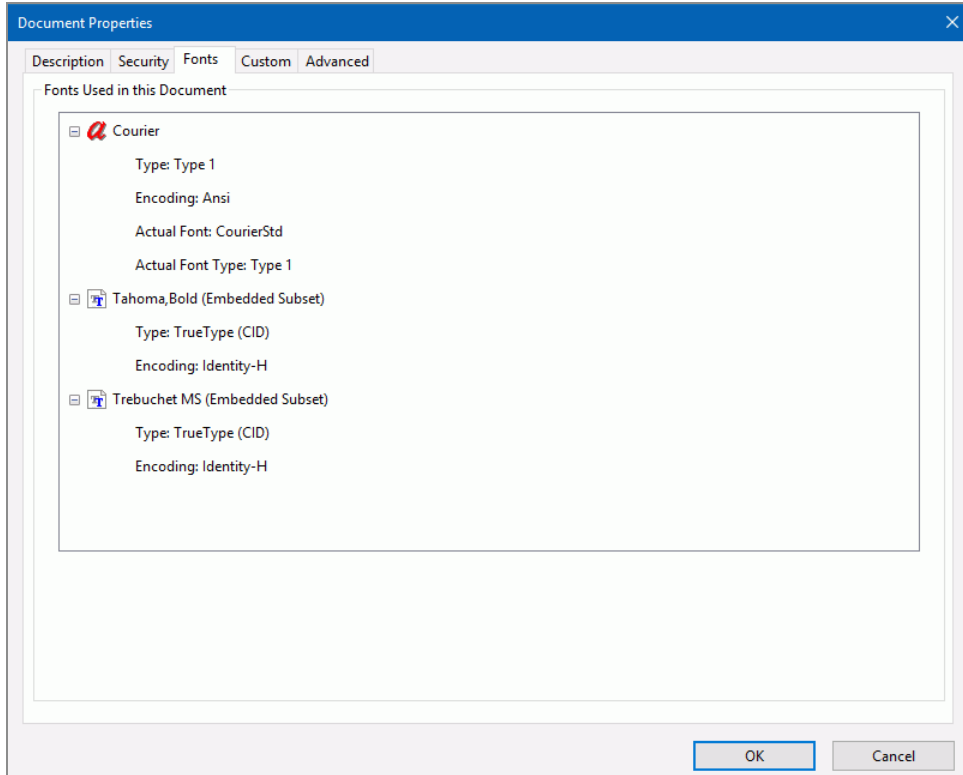

Creating a Compound PDF or PS Report

Compound reports combine multiple reports into a single PDF or PS file. The first PDF or PS report defines the format for the concatenated report, enabling you to intersperse intermediate reports of other formats into one encompassing report. Using compound reports, you can gather data from different data sources and combine reports into one governing report that runs each request and concatenates the output into a single PDF or PS file. You can also embed image files in a compound report.

This is supported with styled formats, such as PDF, PS, EXL2K, or XLSX.

Create a Compound PDF or PS Report

For a compound report that may contain different report types, use the syntax

```
SET COMPOUND= {OPEN|CLOSE} [NOBREAK]
```

or

```
ON TABLE SET COMPOUND {OPEN|CLOSE}
```

Note that when you are using this syntax, you must also include the following code to identify the display format of each of the reports to be concatenated:

```
ON TABLE {HOLD|SAVE} [AS name] FORMAT formatname
```

If all of the reports in the compound set are of the same type, either PDF or PS, you can use the following, more compact, syntax

```
ON TABLE {HOLD|SAVE} [AS name] FORMAT {PDF|PS} {OPEN|CLOSE} [NOBREAK]
```

where:

name

Is the name of the generated file. The name is taken from the first request in the compound report. If no name is specified in the first report, the name HOLD is used.

OPEN

Is specified with the first report, and begins the concatenation process. A report that contains the OPEN attribute must be in PDF or PS format.

CLOSE

Is specified with the last report, and ends the concatenation process.

NOBREAK

Is an optional phrase that suppresses page breaks. By default, each report is displayed on a separate page.

You can use NOBREAK selectively in a request to control which reports are displayed on the same page.

i Note:

- Compound reports cannot be nested.
- You can save or hold the output from a compound report. For details, see [Saving and Reusing Your Report Output](#).
- Multi-Pane reports cannot be used in a Compound Report.

Creating a Compound PDF Report

The following illustrates how to combine three separate PDF reports into one by creating a compound report. Notice that:

- Report 1 specifies ON TABLE HOLD FORMAT PDF OPEN. This defines the report as the first report and sets the format for the entire compound report as PDF.
- Report 2 specifies only the format, ON TABLE HOLD FORMAT PDF.
- Report 3 specifies ON TABLE HOLD FORMAT PDF CLOSE. This defines the report as the last report.

Note that in this example, all reports are set to PDF format. However, when you create a compound report, only the first report must be in either PDF or PS format. Subsequent reports can be in any styled format.

Report 1:

```
SET PAGE-NUM=OFF
TABLE FILE GGSALES
HEADING
"Sales Report"
" "
SUM DOLLARS
BY PRODUCT
ON TABLE SET STYLE *
TYPE=HEADING, SIZE=14,STYLE=BOLD, $
TYPE=REPORT, FONT=ARIAL,SIZE=10,$
ENDSTYLE
ON TABLE HOLD FORMAT PDF OPEN NOBREAK
END
```

Report 2:

```

TABLE FILE GGSALES
HEADING
"Budget Report"
" "
SUM BUDDOLLARS
BY PRODUCT
ON TABLE SET STYLE *
TYPE=HEADING, SIZE=14, STYLE=BOLD, $
TYPE=REPORT, FONT=ARIAL, SIZE=10, $
ENDSTYLE
ON TABLE HOLD FORMAT PDF NOBREAK
END

```

Report 3:

```

TABLE FILE GGSALES
HEADING
"Quota Report"
" "
SUM BUDDOLLARS DOLLARS AND COMPUTE
QUOTAPCT/D7.2 = DOLLARS/BUDDOLLARS * 100; AS '% of,Quota'
BY PRODUCT
ON TABLE SET STYLE *
TYPE=HEADING, SIZE=14, STYLE=BOLD, $
TYPE=REPORT, FONT=ARIAL, SIZE=10, $
ENDSTYLE
ON TABLE HOLD FORMAT PDF CLOSE
END

```

The output displays as a PDF report. Because the syntax for reports 1 and 2 contain the NOBREAK command, the three reports appear on a single page. (Without NOBREAK, each report displays on a separate page.)

Sales Report

<u>PRODCAT</u>	<u>Line Total</u>
CD Players	\$40,694,863.53
Camcorders	\$333,884,927.52
Cameras	\$9,718,752.55
DVD	\$53,182,674.89
Digital Tape Recorders	\$38,773,229.69
PDA Devices	\$233,967,566.49
VCRs	\$23,801,009.34

Inventory Report

<u>PRODCAT</u>	<u>Quantity:</u>
CD Players	308,274
Camcorders	950,700
Cameras	98,141
DVD	241,287
Digital Tape Recorders	524,027
PDA Devices	610,844
VCRs	170,977

Cost of Goods Sold Report

<u>PRODCAT</u>	<u>Line Cost Of Goods Sold</u>
CD Players	30,519,126.00
Camcorders	299,487,742.00
Cameras	8,944,891.00
DVD	47,275,593.00
Digital Tape Recorders	36,157,863.00
PDA Devices	202,123,656.00
VCRs	22,056,033.00

Sales Report			
<u>Product</u>	<u>Dollar Sales</u>		
Biscotti	5387773		
Capuccino	2401556		
Coffee Grinder	2436215		
Coffee Pot	2449585		
Croissant	7758857		
Espresso	3906243		
Latte	11000388		
Mug	4522521		
Scone	4216114		
Thermos	2385829		

Budget Report			
<u>Product</u>	<u>Budget Dollars</u>		
Biscotti	5397019		
Capuccino	2417401		
Coffee Grinder	2355050		
Coffee Pot	2472131		
Croissant	7837027		
Espresso	3904540		
Latte	11055812		
Mug	4547785		
Scone	4152311		
Thermos	2373820		

Quota Report			
<u>Product</u>	<u>Budget Dollars</u>	<u>Dollar Sales</u>	<u>% of Quota</u>
Biscotti	5397019	5387773	99.83
Capuccino	2417401	2401556	99.34
Coffee Grinder	2355050	2436215	103.45
Coffee Pot	2472131	2449585	99.09
Croissant	7837027	7758857	99.00
Espresso	3904540	3906243	100.04
Latte	11055812	11000388	99.50
Mug	4547785	4522521	99.44
Scone	4152311	4216114	101.54
Thermos	2373820	2385829	100.51

Displaying An and AnV Fields With Line Breaks

Using StyleSheet attributes, you can display An (character) and AnV (varchar) fields that contain line breaks on multiple lines in a PDF or PostScript report. Line breaks can be based on line feeds, carriage returns, or a combination of both. If you do not add these StyleSheet attributes, all line feed and carriage return formatting within these fields will be ignored.

Display An and AnV Fields Containing Line Breaks on Multiple Lines

```
TYPE=REPORT,LINEBREAK='type',§
```

where:

REPORT

Is the required component for the LINEBREAK attribute.

'type'

Specifies that line breaks will be inserted in a report based on the following:

LF inserts a line break after each line-feed character found in all An and AnV fields.

CR inserts a line break after each carriage-return character found in all An and AnV fields.

LFCR inserts a line break after each combination of a line-feed character followed by a carriage-return character found in all An and AnV fields.

CRLF inserts a line break after each combination of a carriage-return character followed by a line-feed character found in all An and AnV fields.

i **Note:** The report output must be formatted as PDF or PostScript.

Displaying an Alphanumeric Field With Line Breaks in a PDF Report

The following request defines an alphanumeric named ANLB field with a semi-colon in the middle. The CTRAN function then replaces the semi-colon with a carriage return character and stores this string in a field named ANLBC. On the report output, this field displays on two lines:

```

DEFINE FILE EMPLOYEE
ANLB/A40 ='THIS IS AN An FIELD;WITH A LINE BREAK.';
ANLBC/A40 = CTRAN(40, ANLB, 094, 013 , ANLBC);
END
TABLE FILE EMPLOYEE
PRINT LAST_NAME ANLBC
WHERE LAST_NAME EQ 'BLACKWOOD'
ON TABLE HOLD FORMAT PDF
ON TABLE SET STYLE *
TYPE=REPORT,LINEBREAK='CR', $
ENDSTYLE
END

```

The output is:

LAST_NAME	ANLBC
BLACKWOOD	THIS IS AN An FIELD WITH A LINE BREAK.

Using an Alphanumeric Field With a Line Break in a Subfoot

The following request defines an alphanumeric named ANLB field with a semi-colon in the middle. The CTRAN function then replaces the semi-colon with a carriage return character and stores this string in a field named ANLBC. In the subfoot, this field displays on two lines:

```

DEFINE FILE EMPLOYEE
ANLB/A40 ='THIS IS AN An FIELD;WITH A LINE BREAK.';

```

```

ANLBC/A40 = CTRAN(40, ANLB, 094, 013 , ANLBC);
END
TABLE FILE EMPLOYEE
PRINT FIRST_NAME
BY LAST_NAME
WHERE LAST_NAME EQ 'BLACKWOOD'
ON LAST_NAME SUBFOOT
  " "
  " <ANLBC "
ON TABLE HOLD FORMAT PDF
ON TABLE SET STYLE *
TYPE=REPORT,LINEBREAK='CR', $
ENDSTYLE
END

```

The output is:

LAST_NAME	FIRST_NAME
BLACKWOOD	ROSEMARIE
THIS IS AN An FIELD WITH A LINE BREAK.	

Creating PDF Files on z/OS for Use With UNIX Systems

PDF files created with HOLD FORMAT PDF present a challenge if you work in a z/OS environment and use UNIX-based systems as the server for Adobe or as an intermediate transfer point.

The end of each PDF file has a table containing the byte offset, including line termination characters, of each PDF object in the file. The offsets indicate that each line is terminated by two characters, a carriage return and a line feed, which is the standard Windows text file format. However, records in a UNIX text file are terminated by one character, a line feed only. When using default settings, the offsets in a PDF file will be incorrect, causing an error when Acrobat attempts to open the file. If the file is then transferred in BINARY mode to Windows, it cannot be opened in Acrobat for Windows, as the carriage-return character was not inserted.

One solution has been to transfer the file to the UNIX system in text mode and then transfer in text mode to the Windows system, as the carriage return is added by the transfer facility when transferring to Windows.

If that is not possible or desirable, you can use the SET PDFLINETERM=SPACE command to facilitate binary transfer to Windows from an ASCII-based UNIX system. This command causes an extra space character to be appended to each record of the PDF output file. This extra space acts as a placeholder for the expected carriage return character and makes the object offsets in the file correct when it is transferred from z/OS to a UNIX system. This enables a UNIX server to open a PDF file in that environment.

i Note: A text mode transfer is always required when transferring a text file from a mainframe to any other environment (Windows, ASCII Unix, or EBCDIC Unix).

Specify Line Termination Characters When Creating a PDF File

In a profile, a FOCEXEC, or from the command line, issue the following command:

```
SET PDFLINETERM={STANDARD | SPACE}
```

In a TABLE request, issue the following command

```
ON TABLE SET PDFLINETERM {STANDARD|SPACE}
```

where:

STANDARD

Creates a PDF file without any extra characters. This file will be a valid PDF file if transferred in text mode to a Windows machine, but not to a UNIX machine. If subsequently transferred from a UNIX machine to a Windows machine in text mode, it will be a valid PDF file on the Windows machine.

SPACE

Creates a PDF file with an extra space character appended to each record. This file will be a valid PDF file if transferred in text mode to a UNIX machine, but not to a Windows machine. If subsequently transferred from an ASCII UNIX machine to a Windows machine in binary mode, it will be a valid PDF file on the Windows machine.

Required PDFLINETERM Settings Based on Environment

The following chart will assist you in determining the correct setting to use, based on your environment:

Transferring from z/OS to:	SET PDFLINETERM=
EBCDIC UNIX (text transfer)	SPACE
ASCII UNIX (text transfer)	SPACE
ASCII UNIX (text); then to Windows (binary)	SPACE
UNIX (text); then to Windows (text)	STANDARD
Directly to Windows (text)	STANDARD

Using Excel Display Formats: XLSX, EXL2K, EXL97

You can create a FOCUS report as one of several kinds of Microsoft Excel workbook.

With Excel® 2007, Microsoft® introduced enhanced spreadsheet functionality in a new workbook file format. Using FOCUS, you can retrieve data from any FOCUS supported data source and generate a native XLSX format (Excel 2007, Excel 2010, and Excel 2013) workbook for data analysis and distribution.

EXL2K format generates styled reports in Excel 2000/2003 HTML format for use on other platforms and on the Web. Feature options enable FOCUS users to also download all fields mentioned in their requests in an Excel PivotTable, or include interactive Excel formulas for FOCUS aggregation operations for performing additional "what if" analyses on their data within Excel 2000/2003.

EXL97 is an HTML-based HOLD format for generating formatted Excel 97 spreadsheets. EXL97 is a full StyleSheet driver for accurately rendering all report elements (such as headings and subtotals, for example) as well as applying StyleSheet syntax (such as, conditional styling). You must have Microsoft Excel 97 or higher installed on your computer to display an Excel 97 report.

The report formats and Excel workbooks that you can create are:

- **EXL07 or XLSX (Excel 2007/2010 Workbook).** With Excel 2007, Microsoft introduced enhanced worksheet functionality in a new workbook file format. The XLSX format supports most StyleSheet attributes, allowing for full report formatting. The computer on which the report is being displayed must have Microsoft Excel 2007 or higher installed.
- **EXL2K (Excel 2000/2003 Workbook).** The EXL2K format supports most StyleSheet attributes, allowing for full report formatting. The computer on which the report is being displayed must have Microsoft Excel 2000 or higher installed. By default, leading and internal blanks are compressed on the report output. For information on preserving them, see [Preserving Leading and Internal Blanks in Report Output](#).

In addition, FOCUS supports two EXL2K variations: EXL2K FORMULA and EXL2K PIVOT. When any of these formats is specified, additional processing is done.

- **EXL2K FORMULA.** If you display a report using the format variation EXL2K FORMULA, the resulting worksheet will contain Excel formulas that calculate and display the results of any type of summed information (such as column

totals, row totals, and sub-totals).

- **EXL2K PIVOT.** Generates a fully functional Excel PivotTable, an Excel tool for analyzing complex data.
- **EXL97 (Excel 97 Spreadsheet).** EXL97 is an HTML-based display format that opens in Excel 97 or higher and supports report formatting and drill-downs. The computer on which the report is being displayed must have Microsoft Excel 97 or higher installed.

Viewing Excel Workbooks in the Browser vs. the Excel Application

Your desktop settings determine whether Excel output sent to the client is displayed in an Internet Browser window or within the Excel Application. When Excel output has been defined within the Windows environment to **Browse in same window**, the workbook generated by a WebFOCUS request is opened within an Internet Explorer browser window. When the **Browse in same window** option is unchecked for the .xls file type, the browser window created by WebFOCUS is blank because the report output is displayed in the standalone Excel application window.

- In Windows XP and earlier, file type specific settings are managed on the desktop within Windows Explorer by selecting Tools/Folder Options, clicking the **File Types** tab, selecting the extension (.xls or .xlsx), clicking the **Advanced** button, and checking the **Browse in same window** box.

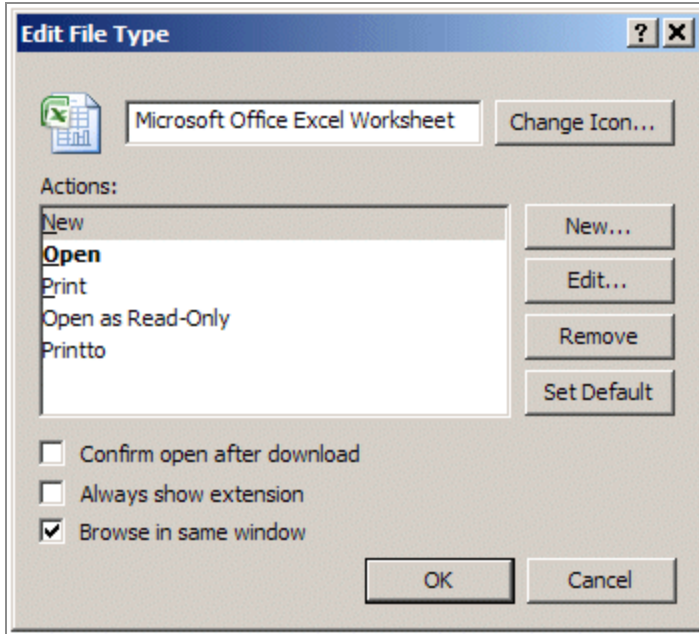

- In Windows 7, Microsoft removed the desktop settings that support opening worksheets in the browser. This means that to change this behavior, you can no longer simply navigate to the Folder Options dialog box, but that you must change a registry setting. This change is documented in the Microsoft Knowledge Base Article ID 927009 at the following Web site:

<http://support.microsoft.com/kb/927009>

i Note: This works the same for both EXL2K and XLSX formats. The only difference is the selection of file type based on the version of Excel output you will be generating.

Redirection and Excel Drilldown Reports

The WebFOCUS Client can use redirection when passing the report output to the client application. When redirection is enabled, the WebFOCUS Client saves report output in a temporary directory when a request is executed. Then, an HTTP call is made from the browser to retrieve the temporary stored output for display. When redirection is disabled, the report output is sent directly to the browser without any buffering.

When redirection is enabled, drilldowns within Excel reports will work differently depending on whether the workbook is opened in the browser or in the Excel application.

For information about launching Excel in the browser or as an application, see [Using Excel Display Formats: XLSX, EXL2K, EXL97](#).

- **For workbooks opened in the browser:** Drilldowns will work with redirection enabled because the browser session has access to the HTTP header and/or cookies that need to be sent with the HTTP request to the WebFOCUS Client in order to obtain the redirected target workbook file.
- **For workbooks opened outside the browser in the Excel application:** The redirection context is not retained by the Excel application, so drilldown reports will not have the information required to access the redirected files. The initial workbook will open within Excel, but the target drilldown workbook will not open and you will receive a message stating **You are not allowed to access this viewer file**.

For additional information about redirection options, see *WebFOCUS Administration Console Client Settings* described in the *WebFOCUS Security and Administration* manual.

Assigning XLSX Format to Your Report Output

XLSX (Excel 2007/2010) format generates fully styled reports in Excel 2007/2010 binary display format. The FOCUS procedure generates a new workbook containing a single worksheet with the report output containing your defined report elements (headings and subtotals), as well as StyleSheet syntax (such as conditional styling and drilldowns):

- XLSX format accurately displays formatted numeric, character and date formats.
- Within each generated worksheet, the columns in the report are automatically sized to fit the largest value in the column. FOCUS calculates the width of each data column based on the font and size requirement of all cells in that column using font metrics developed for other styled formats, including PDF and DHTML. Calculations are based on the data and title elements of the report. Heading and footing elements are not used in the sizing calculation and will be sized based on the data column requirements.
- Tab names within the workbook can be customized to provide better descriptions of the worksheet content using the TITLETEXT StyleSheet attribute described in [Using Excel Display Formats: XLSX, EXL2K, EXL97](#).
- By default, leading, internal, and trailing blanks are compressed in cells within the worksheet.
- An Excel 2007/2010 worksheet can contain 1,048,576 rows by 16,384 columns. FOCUS

will generate worksheets larger than these defined limits, but Excel 2007/2010 will have difficulty opening the resulting workbook, and the data that exceeds the Excel 2007/2010 limits will be truncated.

Overview of XLSX Format

In order to open Excel 2007/2010 workbooks generated in either the browser or the Excel application, you must have Excel 2007 or greater installed on the desktop.

Excel 2000 and Excel 2003 can be updated to read Excel 2007 or 2010 workbooks using the Microsoft Office Compatibility Pack available from the Microsoft download site (<http://www.microsoft.com/downloads/en/default.aspx>).

Building the .xlsx Workbook File

Microsoft changed the format and structure of the Excel workbook in Excel 2007. The new .xlsx file is a binary compilation of a group of xml files. Generating this new file format using FOCUS is a two-step process that consists of generating the xml files containing the report output and zipping the xml documents into the binary .xlsx format. The WebFOCUS Reporting Server performs the xml generation process. The zipping process can be completed either by the client (WebFOCUS Servlet) or the server (JSCOM3):The zipping process can be completed by the client (WebFOCUS Servlet), the server (JSCOM3), or the C-based zip local mode:

- **WebFOCUS Servlet.** The WebFOCUS Client within the application server performs the zipping process. This can be done within the local client or through a remotely accessed client. The servlet method is the default approach defined for each WebFOCUS Client, with the client pointing to itself, by default.
- **JSCOM3.** The Java layer of the WebFOCUS Reporting Server performs the zipping operation. This option should be used when the WebFOCUS Servlet is configured on a secured web or application server. This is because JSCOM3 does not require URL access to a remote WebFOCUS Client.
- **C-Based Zip Local Mode.** The zipping and unzipping operation of .xlsx files is performed locally, without any communication to a server. Running in C-based zip local mode provides performance enhancements and will also work when called directly by the server or using a WebFOCUS Servlet URL.

Select the Method for Zipping the .xlsx File Using EXCELSERVURL

You designate the method and location where the zipping will occur by setting EXCELSERVURL to a URL (for the WebFOCUS Servlet) or to a blank (for JSCOM3). You can set this value for a specific procedure or for the entire environment:

- **For a procedure.** Issue the SET EXCELSERVURL command within the procedure.
- **For the entire environment.** Edit the IBIF_excelservurl variable in the WebFOCUS Administration Console by selecting:

Configuration/Client Settings/General/IBIF_excelservurl

For more information on accessing the WebFOCUS Administration Console and setting the IBIF_excelservurl variable, see the *ibi™ WebFOCUS® Security and Administration* manual.

The value you assign to EXCELSERVURL determines whether the WebFOCUS Servlet or JSCOM3 performs the zipping operation:

- **Specifying the Servlet.** To specify that the WebFOCUS Servlet should be used, set the EXCELSERVURL parameter or the IBIF_variable to the URL. For example,

In a procedure:

```
SET EXCELSERVURL = http://servername:8080/ibi_apps
```

In the WebFOCUS Administration Console:

```
IBIF_excelservurl = http://servername:8080/ibi_apps
```

- **Specifying JSCOM3.** To specify that JSCOM3 should be used within the current WebFOCUS Reporting Server, set EXCELSERVURL to a blank or an empty string.

In a procedure:

```
SET EXCELSERVURL = ''
```

In the WebFOCUS Administration Console:

```
IBIF_excelservurl = ''
```

By default, each WebFOCUS Client contains the following URL definition that points to itself:

```
&URL_PROTOCOL://&servername:&server_port&IBIF_webapp
```

Designate C-Based Zip Local Mode for Zipping the .xlsx File

To designate C-based zip local mode for zipping a .xlsx file, issue the following command in a procedure:

```
SET XLSXLOCALZIP = ON
```

Building the XLSX Workbook File

Microsoft changed the format and structure of the Excel workbook in Excel 2007. The new .xlsx file is a binary compilation of a group of XML files. Generating this new file format using FOCUS is a two step process that consists of generating the XML files containing the report output and zipping the XML documents into the binary .xlsx format.

The zipping process requires the following command in a profile or FOCEXEC.

```
SET EXCELSERVURL = LOCAL
```

You can also include this command in a TABLE request using the following syntax.

```
ON TABLE SET EXCELSERVURL LOCAL
```

Building the XLSX Workbook File

Microsoft changed the format and structure of the Excel workbook in Excel 2007. The new .xlsx file is a binary compilation of a group of XML files. Generating this new file format

using FOCUS is a two step process that consists of generating the XML files containing the report output and zipping the XML documents into the binary .xlsx format.

The zipping process requires code included in the webfocus.war file of the WebFOCUS client, which is deployed as the ibi_apps context root on an application server such as Tomcat.

You must have an installed version of the WebFOCUS Client so that ibi_apps is deployed. The application server must be running when you issue the HOLD FORMAT XLSX command in your report request. The WebFOCUS Client does not have to be running. Your request must point to the URL where ibi_apps is deployed using the SET EXCELSERVURL command:

```
SET EXCELSERVURL = http://servername:8080/ibi_apps
```

where:

servername

Is the name of the machine where the application server is running.

8080

Is the default port used by the WebFOCUS Client to communicate with the application server.

After the XLSX output file is generated, you must FTP it to your PC in binary mode.

 **Note:** This setting is also required for generating PPTX output files.

Building the .xlsx Workbook File

Microsoft changed the format and structure of the Excel workbook in Excel 2007. The new .xlsx file is a binary compilation of a group of xml files. Generating this new file format using FOCUS is a two step process that consists of generating the xml files containing the report output and zipping the xml documents into the binary .xlsx format. The WebFOCUS Reporting Server performs the xml generation process. The zipping process can be completed either by the client (WebFOCUS Servlet) or the server (JSCOM3):

- **WebFOCUS Servlet.** The WebFOCUS Client within the application server performs the zipping process. This can be done within the local client or through a remotely

accessed client. The servlet method is the default approach defined for each WebFOCUS client, with the client by default pointing to itself.

- **JSCOM3.** The java layer of the WebFOCUS Reporting Server performs the zipping operation. This option can be used within secured environments because it does not require URL access to a remote client.

Select the Method for Zipping the .xlsx File

You designate the method and location where the zipping will occur by setting EXCELSERVURL to a URL (for the WebFOCUS Servlet) or to a blank (for JSCOM3). You can set this value for a specific procedure or for the entire environment:

- **For a procedure.** Issue the SET EXCELSERVURL command within the procedure.
- **For the entire environment.** Edit the IBIF_excelservurl variable in the WebFOCUS Administration Console by selecting:

Configuration/Client Settings/General/IBIF_excelservurl

For more information on accessing the WebFOCUS Administration Console and setting the IBIF_excelservurl variable, see the *WebFOCUS Security and Administration* manual.

The value you assign to EXCELSERVURL determines whether the WebFOCUS Servlet or JSCOM3 performs the zipping operation:

- **Specifying the Servlet.** To specify that the WebFOCUS Servlet should be used, set the EXCELSERVURL parameter or the IBIF_variable to the URL of a WebFOCUS 7.7.02 or higher client configuration. For example,

In a procedure:

```
SET EXCELSERVURL = http://servername:8080/ibi_apps
```

In the WebFOCUS Administration Console:

```
IBIF_excelservurl = http://servername:8080/ibi_apps
```

- **Specifying JSCOM3.** To specify that JSCOM3 should be used within the current WebFOCUS Reporting Server, set EXCELSERVURL to blank or an empty string.

In a procedure:

```
SET EXCELSERVURL = ''
```

In the WebFOCUS Administration Console:

```
IBIF_excelservurl = ''
```

By default, each WebFOCUS client contains the following URL definition that points to itself:

```
&URL_PROTOCOL://&SERVER_NAME:&SERVER_PORT&IBIF_webapp
```

Generate an Excel 2007 or 2010 Workbook

You can specify that a report should be saved to an Excel 2007/2010 workbook, displayed in the browser, or displayed in the Excel 2007/2010 application.

```
ON TABLE HOLD AS name FORMAT XLSX
```

where:

name

Specifies a file name for the generated workbook.

Opening EXL07 Report Output in Excel 2000/2003

Excel 2000 and Excel 2003 can be updated to read Excel 2007 or 2010 workbooks using the Microsoft Office Compatibility Pack available from the Microsoft download site (<http://www.microsoft.com/downloads/en/default.aspx>). When the file extension of the file being opened is .xlsx (Excel 2007/2010 workbook), the Microsoft Office Compatibility Pack performs the necessary conversion to allow Excel 2000/2003 to read and open it.

In addition to the Microsoft Office Compatibility Pack, it is important to enable the WebFOCUS Client Redirection Settings **Save As** option so that Excel 2000/2003 will be able

to open the Excel 2007/2010 report output without users first having to save it to their machine with the .xlsx file extension. The WebFOCUS Client processing Redirection Settings **Save As** option configures how the WebFOCUS Client sends each report output file type to the user's machine. This option can be set as follows:

- **Save As Option disabled (NO).** The WebFOCUS Client Redirection Setting **Save As** is disabled by default. When the **Save As** option is disabled, the WebFOCUS Client sends report output to the user's machine in memory with the application association specified for the report format in the WF Client Redirection Settings configuration file (mime.wfs).

The application association for Excel 2007/2010 is:

```
application/vnd.openxmlformats-officedocument.spreadsheetml.sheet
```

A user's machine that does not have Excel 2007/2010 installed will not recognize the application association for Excel 2007/2010 and will display the following message:



The Excel 2000/2003 user can select **Save** and provide a filename with the .xls extension to save the report output to their machine. The user can then open the .xls file directly from Excel 2000/2003.

- **Save As Option enabled (YES).** When the WebFOCUS Redirection **Save As** option is enabled, the WebFOCUS Client sends the report output to the user as a file with the extension specified in the WebFOCUS Client Redirection Settings configuration file (mime.wfs).

Upon receiving the file, Windows will display the File Download prompt asking the user to Open or Save the file with the identified application type. As seen in the following image, the File Download prompt displays the Name with the xlsx file

extension for the report output that is recognized as an Excel 2007/2010 file type.



Note: The download prompt will display for all users, including users who have Excel 2007/2010 installed on their machines.

If an Excel 2000/2003 user chooses to open the file, the Microsoft Office Compatibility Pack will recognize the .xlsx file extension and perform the necessary conversion to allow Excel 2000/2003 to read the Excel 2007/2010 workbook.

If an Excel 2007/2010 user chooses to open the file, Excel 2007/2010 will recognize the .xlsx file extension and read the Excel 2007/2010 workbook.

For additional information on WebFOCUS Client Redirection Settings, see the *WebFOCUS Security and Administration Guide*.

Formatting Values Within Cells in XLSX Report Output

FOCUS formats defined in Master Files or within a FOCEXEC will be represented in the resulting cells in an Excel 2007 or 2010 worksheet. Where possible, the FOCUS formats are translated to custom Excel formats and applied to values passed as raw data. Each data value passed to a cell in Excel 2007/2010 is defined with a value and a format mask pair. The data format is associated with the cell rather than embedded in the value. This technique provides enhanced support for editing worksheets generated by FOCUS. New values entered into existing cells will retain the cell formats and continue to display in the style defined for the column within the report.

The following type of data can be passed to Excel 2007/2010:

- **Numeric.** Where corresponding Excel format masks can be defined, numeric values are passed as raw values with associated format masks. In instances where an equivalent format mask cannot be defined, the numeric value is passed as a text string.
- **Alphanumeric.** Alphanumeric formats are passed to Excel 2007/2010 as text strings, with General format defined. By default, General format presents all text fields as left justified. Alignment and other styling attributes can be applied to these cells to override the default.
- **Date formats.** Data that contain sufficient elements to define a valid Excel date format are passed as raw date values with the FOCUS data formats translated to Excel date format masks. In FOCUS formats that do not contain sufficient information to create valid Excel date values, the dates are converted to text strings.
- **Date-Time formats.** Date-time values are passed as raw date-time values with FOCUS formats translated to Excel date-time format masks using Custom formats.
- **Text.** Text values are passed as strings with General Format defined (as with alphanumeric data).



Note: This behavior is a change from EXL2K format, where cells containing dates and more complex numeric formats were passed as formatted text.

Displaying Formatted Numeric Values in XLSX Report Output

Each numeric FOCUS format is translated to a custom numeric Excel format. The numeric value is displayed in the Excel formula bar for the selected cell. Within the actual cell, the value with the format mask applied displays.

The FOCUS formats for the following numeric data types are translated into Excel 2007/2010 format masks supporting full editing within the resulting workbook:

- Data types: E, F, D, I, P.
- Comma edit option (C).

- Zero suppression (S).
- Leading zero (L).
- Floating currency symbol (M).
- Comma Suppression (c).
- Right-side minus sign (-).
- Credit negative (CR).
- Bracket negative (B).
- Fixed extended currency symbol (!d, !e, !l, !y).
- Floating extended currency symbol (!D, !E, !L, !Y).
- Percent (%).

Passing Numeric Formats to XLSX Report Output

In the following example, the DOLLARS field is assigned different numeric formats to demonstrate different available options. The column titles have been edited to display the FOCUS format options that have been applied:

```
TABLE FILE GGSales
SUM DOLLARS/D12.2 AS 'D12.2'
    DOLLARS/D12C AS 'D12C'
    DOLLARS/D12CM AS 'D12CM'
BY REGION
BY CATEGORY
ON TABLE HOLD FORMAT XLSX
ON TABLE SET BYDISPLAY ON
END
```

In the resulting worksheet, notice that cell C2 containing the DOLLAR value for **Midwest Coffee** presents the value with the FOCUS format D12.2, which presents the comma and two decimal places. On the formula bar, the actual value is presented without any formatting. Examine each of the DOLLAR values in each row to see that the value as displayed in the formula bar remains the same, and only the display values presented in each cell change.

Also notice that with SET BYDISPLAY ON, the BY field values are repeated for every row on the worksheet. This creates fully qualified data rows that can be used with various data

sorting, filtering, and table features in Excel without losing valuable information. This setting is recommended as a best practice for all worksheets:

A1						
fx Region						
	A	B	C	D	E	F
1	Region	Category	D12.2	D12C	D12CM	
2	Midwest	Coffee	4,178,513.00	4,178,513	\$4,178,513	
3	Midwest	Food	4,338,271.00	4,338,271	\$4,338,271	
4	Midwest	Gifts	2,883,881.00	2,883,881	\$2,883,881	
5	Northeast	Coffee	4,164,017.00	4,164,017	\$4,164,017	
6	Northeast	Food	4,379,994.00	4,379,994	\$4,379,994	
7	Northeast	Gifts	2,848,289.00	2,848,289	\$2,848,289	
8	Southeast	Coffee	4,415,408.00	4,415,408	\$4,415,408	
9	Southeast	Food	4,308,731.00	4,308,731	\$4,308,731	
10	Southeast	Gifts	2,986,240.00	2,986,240	\$2,986,240	
11	West	Coffee	4,473,517.00	4,473,517	\$4,473,517	
12	West	Food	4,202,337.00	4,202,337	\$4,202,337	
13	West	Gifts	2,977,092.00	2,977,092	\$2,977,092	
14						

The following example uses Fixed Dollar (N) format, as well as multiple combined format options. Each FOCUS format option is translated to the appropriate Excel 2007/2010 format mask and applied to the cell value:

```
TABLE FILE GGSales
SUM BUDDOLLARS/D12N
   DOLLARS/D12M
COMPUTE OVERBUDGET/D12BMc=BUDDOLLARS-DOLLARS; AS 'Over Budget'
BY REGION
BY CATEGORY
ON TABLE HOLD FORMAT XLSX
ON TABLE SET BYDISPLAY ON
END
```

Notice the fixed numeric format defined for the BUDDOLLARS column (Column C) presents the local currency symbol in a fixed position within each cell, regardless of the size of the data value. On the formula bar, the values in the **Over Budget** calculated field is passed as a negative value where appropriate. In the actual cells, the bracketed styling is applied to the negative values as part of the custom Excel 2007/2010 format mask:

	A	B	C	D	E	F
1	Region	Category	Budget Dollars	Dollar Sales	Over Budget	
2	Midwest	Coffee	\$ 4,086,032	\$4,178,513	(\$92481)	
3	Midwest	Food	\$ 4,220,721	\$4,338,271	(\$117550)	
4	Midwest	Gifts	\$ 2,887,620	\$2,883,881	\$3739	
5	Northeast	Coffee	\$ 4,252,462	\$4,164,017	\$88445	
6	Northeast	Food	\$ 4,453,907	\$4,379,994	\$73913	
7	Northeast	Gifts	\$ 2,870,552	\$2,848,289	\$22263	
8	Southeast	Coffee	\$ 4,431,429	\$4,415,408	\$16021	
9	Southeast	Food	\$ 4,409,288	\$4,308,731	\$100557	
10	Southeast	Gifts	\$ 2,967,254	\$2,986,240	(\$18986)	
11	West	Coffee	\$ 4,523,963	\$4,473,517	\$50446	
12	West	Food	\$ 4,183,244	\$4,202,337	(\$19093)	
13	West	Gifts	\$ 2,934,306	\$2,977,092	(\$42786)	
14						
15						

Using Numeric Formats in Report Headings and Footings

By default, headings and footings are passed to Excel as a single character string. Spot markers are not supported for positioning within each line. Numeric fields and dates passed in headings and footings are passed as text strings within the overall heading or footing contents.

To display numeric fields and dates within headings and footings as numeric or date values, use HEADALIGN=BODY in the StyleSheet to define each of the items in the heading as an individual cell. Each cell containing numeric or date values will then be passed as the appropriate value with the associated format mask.

For information about the HEADALIGN attribute, see [Aligning a Heading or Footing Element in an HTML, EXL07, EXL2K, or PDF Report](#).

Using Numeric Format Punctuation in Headings and Footings

For data columns, all currency formats are translated using the Excel 2007/2010 format masks that use the punctuation rules defined by the regional settings of the desktop.

In languages that use Continental Decimal Notation, the currency definitions designate that a comma is used as the decimal separator, and a period is used as the thousands

separator, so D12.2CM may present the value as \$ 9.999,99 rather than the English (United States) value \$ 9,999.99. In headings and footings, you can designate that punctuation should be converted to Continental Decimal notation by issuing the SET CDN=ON command. With this setting in effect, the data embedded within heading and footing text strings will be formatted using the converted punctuation. Specify HEADALIGN=BODY to delineate items as individual cells and to retain the numeric formatting within the field which will follow the same rules as the report data within the data columns.

Passing Dates to XLSX Report Output

Most translated and smart dates can be sent to Excel 2007/2010 as standard date values with format masks, enabling Excel to use them in functions, formulas, and sort sequences.

Translating FOCUS Dates to Excel 2007/2010 Dates

The following request against the GGSales data source creates the date January 1, 2010 and converts it to four date formats with translated text:

```
DEFINE FILE GGSales
NEWDATE/MDYY = '01/01/2010';
WRMtrDY/WRMtrDY = NEWDATE;
wDMTY/wDMTY= NEWDATE;
wrDMTRY/wrDMTRY= NEWDATE;
wrYMtrD/wrYMtrD= NEWDATE;
END
TABLE FILE GGSales
SUM DATE NOPRINT
NEWDATE WRMtrDY wDMTY wrDMTRY wrYMtrD
ON TABLE HOLD FORMAT XLSX
END
```

The following table shows how the dates should appear:

FOCUS Format	XLSX Displays	XLSX Value
WRMtrDY	Friday, January 1 10	1/1/2010

FOCUS Format	XLSX Displays	XLSX Value
wDMTY	Fri, 1 Jan 10	1/1/2010
wrDMTRY	Friday, 1 January 1	1/1/2010
wrYMtrD	Friday, 10 January 1	1/1/2010

In Excel 2007/2010, all of the cells have a date value with format masks, and all month and day names are in mixed-case, regardless of how the case has been specified in the FOCUS format. The output is:

	A	B	C	D	E
1	NEWDATE	WRMtrDY	wDMTY	wrDMTRY	wrYMtrD
2	01/01/2010	Friday, January 1 10	Fri, 1 Jan 10	Friday, 1 January 10	Friday, 10 January 1

Passing Dates Without a Day Component

Date formats that do not specify the day value explicitly are defined as the date value of the first day of the month. Therefore, the value placed in the cell may be different from the day component value in the source data field and may produce unexpected results when used for sorting or date calculations in an Excel formula.

The following table shows how FOCUS date formats are represented in XLSX. The table shows how the value is preserved in the cell and how the display is generated using the format mask that corresponds to the FOCUS date format.

```
DATEFLD/MDYY = '01/02/2010'
```

FOCUS Format	XLSX Displays:	XLSX Value
DMYY	02/01/2010	1/2/2010
MY	01/10	1/1/2010
MTY	Jan, 10	1/1/2010
MTDY	Jan 2, 10	1/2/2010

Passing FOCUS Dates With and Without a Day Component to XLSX Report Output

The following request against the GGSales data source creates the date January 2, 2010 and passes it to Excel 2007/2010 with formats MDYY, DMY, MY, and MTDY:

```
DEFINE FILE GGSales
NEWDATE/MDYY = '01/02/2010';
END
TABLE FILE GGSales
SUM DATE NOPRINT
NEWDATE AS 'MDYY' NEWDATE/DMY AS 'DMY' NEWDATE/MY AS 'MY'
      NEWDATE/MTDY AS 'MTDY' NEWDATE/MTDY AS 'MTDY'
ON TABLE HOLD FORMAT XLSX
END
```

Columns D and E have actual date values with format masks, displayed by Excel 2007/2010 in mixed-case. Since the MTDY format does not have a day component, the date value stored is the first of January 2010 (1/1/2010), not the second of January 2010 (1/2/2010):

	A	B	C	D	E
1	MDYY	DMY	MY	MTDY	MTDY
2	01/02/2010	02/01/2010	01/10	Jan, 10	Jan 2, 10

Passing Date Components for Use in Excel Formulas

Dates formatted as individual components (for example, D, Y, M, W) are passed to Excel as numeric values that can be used as parameters to Excel date functions. The values are passed as general format that are recognized by Excel as numbers.

Passing Numeric Date Components to XLSX Report Output

The following request against the GGSales data source creates the date January 1, 2010 and extracts numeric date components, passing them to Excel 2007/2010:

```

DEFINE FILE GGSales
NEWDATE/MDYY = '01/01/2010';
D/D= NEWDATE;
Y/Y = NEWDATE;
W/W=NEWDATE;
w/w=NEWDATE;
M/M = NEWDATE;
YY/YY = NEWDATE;
END
TABLE FILE GGSales
SUM DATE NOPRINT
NEWDATE D Y W w M YY
ON TABLE HOLD FORMAT XLSX
END

```

The output is:

	A	B	C	D	E	F	G
1	NEWDATE	D	Y	W	w	M	YY
2	01/01/2010	01	10	5	5	01	2010

Passing Quarter Formats

Date formats that contain a Quarter component are always passed to Excel as text strings since Excel does not support Quarter formats.

Passing Dates With a Quarter Component to Excel 2007

The following request against the GGSales data source creates the date January 1, 2010 and converts it to date formats that contain a Quarter component:

```

DEFINE FILE GGSales
NEWDATE/MDYY = '01/01/2010';
Q/Q= NEWDATE;
QY/QY = NEWDATE;
YBQ/YBQ=NEWDATE;
END
TABLE FILE GGSales

```

```
SUM DATE NOPRINT
NEWDATE Q QY YBQ
ON TABLE HOLD FORMAT XLSX
END
```

In Excel 2007 or 2010, the cells containing dates with Quarter components have General format. To see this, open the Format Cells dialog box.

The output is:

	A	B	C	D
1	NEWDATE Q	QY	YBQ	
2	01/01/2010	Q1	Q1 10	10 Q1

Passing Date Components Defined as Translated Text

Date formats that do not contain sufficient information to present a valid date result in Excel are not translated to a value, including formats that do not contain year and/or month information. These dates will be sent to Excel as text. In the absence of complete information, the year defaults to the current year, so the value sent would be incorrect if this type of format was passed as a date value. The following formats will not be sent as values:

- MT, MTR, Mt, Mtr
- W, w, WR, wr

When date formats are passed to Excel 2007/2010 with format masks, all month and day names are in mixed-case, regardless of how the case has been specified in the FOCUS format. However, since the values in this example are always sent as text, the casing defined in the FOCUS format is applied in the resulting cell.

Passing Date Components Defined as Translated Text to XLSX Report Output

The following request against the GGSALES data source creates the date January 1, 2010 and converts it to date formats that are defined as either month name or day name:

```
DEFINE FILE GGSALES
NEWDATE/MDYY = '01/01/2010';
MT/MT= NEWDATE;
MTR/MTR= NEWDATE;
Mtr/Mtr = NEWDATE;
WR/WR = NEWDATE;
wr/wr = NEWDATE;
END
TABLE FILE GGSALES
SUM DATE NOPRINT
NEWDATE MT MTR Mtr WR wr
ON TABLE HOLD FORMAT XLSX
END
```

In Excel 2007 or 2010, the cells containing the days have General format. To see this, open the Format Cells dialog box.

The output is:

	A	B	C	D	E	F
1	NEWDATE	MT	MTR	Mtr	WR	wr
2	01/01/2010	Jan	January	January	FRIDAY	Friday

Usage Notes for Date Values in XLSX Report Output

- The following date formats are not supported in XLSX. They will translate into Excel General format and possibly produce unpredictable results:
 - JUL, YYJUL, and I2MT.
 - Dates stored as a packed or alphanumeric field with date display options.
- Excel only supports mixed-case, not all uppercase or all lowercase for text dates. All

FOCUS date formats containing text present in XLSX as mixed-case, regardless of the casing parameters defined in the FOCUS format. For example, MTRDY will generate the date string JANUARY 2, 10 in standard FOCUS, but when sent to XLSX as a date value, it will be presented as January 2, 10.

Passing Date-Time to XLSX

Most FOCUS date-time formats can be sent to XLSX as standard date/time values with format masks, enabling Excel to use them in functions, formulas, and sort sequences.

As with the Date formats, Excel only supports mixed-case to date-time fields, so if the date-time format contains text and is supported by Excel, the text will be in mixed-case, regardless of the casing defined within the FOCUS format.

Passing Date-Time to XLSX

The following request shows an example against the GGSales data source.

```

DEFINE FILE GGSales
DT1/HYYMDm WITH REGION = DT(20100506 16:17:01.993876);
DPT1/HDMTYm = DT1;
ALPHA_DATE1/A30 = HCNVRT(DT1, '(HYYMDm)', 30, 'A30');
END
TABLE FILE GGSales
PRINT
ALPHA_DATE1
DT1 AS 'HYYMDm'
DPT1 AS 'HDMTYm'
DT1/HdMTYYBS AS 'HdMTYYBS'
DT1/HdMTYYBs AS 'HdMTYYBs'
ON TABLE SET SPACES 1
IF RECORDLIMIT EQ 1
ON TABLE PCHOLD FORMAT XLSX
END

```

The output is:

A	B	C	D	E
ALPHA_DATE1	HYYMDm	HDMTYm	HdMTYYBS	HdMTYYBs
2010/05/06 16:17:01.993876	2010/05/06 16:17:01.993	06 May 2010 16:17:01.993	6 May 2010 16:17:01	6 May 2010 16:17:01.993

i Note: Minutes by themselves are not supported in Excel and will be sent as an integer to XLSX with a Custom format.

Also, Excel time formats only support to the milliseconds. FOCUS formats that display microseconds will send the value to Excel, but the value will be rounded to milliseconds within the worksheet if the cell is edited.

The following table shows how the date-time values appear.

FOCUS Format	XLSX Displays	XLSX Value
HYMDm	2010/05/06 16:17:01.993	5/6/2010 4:17:02 PM
HDMTYYm	06 May 2010 16:17:01.993	5/6/2010 4:17:02 PM
HdMTYYBS	6 May 2010 16:17:01	5/6/2010 4:17:01 PM
HdMTYYBs	6 May 2010 16:17:01.993	5/6/2010 4:17:02 PM

Generating Native Excel Formulas in XLSX Report Output

When you display or save a tabular report request using XLSX FORMULA, the resulting worksheet contains an Excel formula that computes and displays the results of any type of summed information, such as column totals, row totals, subtotals, and calculated values, rather than static numbers. A formula for a calculated value is generated by translating the internal form of the FOCUS expression into an Excel formula. Worksheets saved using the XLSX FORMULA format are interactive, allowing for "what if" scenarios that immediately reflect any additions or modifications made to the data.

Understanding Formula Versus Value

The XLSX FORMULA format will generate formulas rather than values for the following FOCUS TABLE commands: ROW-TOTAL, COLUMN-TOTAL, SUB-TOTAL, SUBTOTAL, and SUMMARIZE, as well as for calculations performed by functions.

- A DEFINE field will always generate a constant value and not a formula.
- COMPUTE will generate the formula, except when the COMPUTE is equal to a single variable. In that case, the constant is placed and not the formula.
- If your report contains a calculated value (generated by the COMPUTE or RECOMPUTE command), all of the fields referenced by the calculated value must be displayed in the report in order for a cell reference to be included in the formula. If the referenced column is not displayed in the workbook, the data value will be placed in the formula, rather than a cell reference. Additionally, if the value cannot be reliably calculated based on the information passed to Excel, the value, rather than an expression, will be used. For example, using the LAST function in FOCUS cannot be translated correctly into Excel. In this instance, the LAST value is used in the expression, rather than a cell reference.

XLSX FORMULA is not supported with financial reports created with Financial Modeling Language (FML).

For more information, see [Translation Support for FORMAT XLSX FORMULA](#).

Translation Support for FORMAT XLSX FORMULA

This topic describes translation support for FORMAT XLSX FORMULA. Use of unsupported FOCUS features may produce unreliable results.

- All standard operators are supported. These include arithmetic operators, relational operators, string operators, IF/THEN/ELSE, and logical operators. However, column notation is not supported.

The IS-PRESENT, IS-MISSING, IS-FROM, FROM, NOT-FROM, IS-MORE-THAN, IS-LESS-THAN, CONTAINS, and OMITS operators are not supported.

The logical operators AND and OR are not supported in conditional (IF-THEN-ELSE) or logical expressions.

- The following functions are supported:

ABS, ARGLEN, ATODBL, BYTVAL, CHARGET, CTRAN, DMOD, DOWK, DOWK, DOWKL, EXP, FMOD, HEXBYT, HHMMSS, IMOD, LCWORD, LOCASE, LOG, MAX, MIN, OVLAY, POSIT, RDUNIF, SQRT, SUBSTR, TODAY, and UPCASE. The EDIT function is supported

for converting formats (one argument variant). It is not supported for editing strings.

The functions CTRFLD, LJUST, and RJUST are not recommended for justifying data in Excel columns. With the use of Excel proportional fonts, the StyleSheet JUSTIFY attribute is more appropriate.

Be cautious when using functions that use decimal values as an argument (BYTVAL, CTRAN, HEXBYT). Based on whether the operating environment is EBCDIC or ASCII, the results may be different.

- XLSX FORMULA is not supported with the following FOCUS commands and phrases:
 - DEFINE
 - OVER
 - FOR
 - NOPRINT
 - Multiple display (PRINT, LIST, SUM, and COUNT) commands
 - SEQUENCE StyleSheet attribute
 - RECAP
 - SET HIDENULLACRS
 - SET SUBTOTALS = ABOVE
 - LAST
- The BYDISPLAY ON setting is recommended to allow the sort field value to be available on all rows for recalculations.
- If an expression requires more than 1024 characters, FOCUS will place the value into the cell, and not the formula.
- Conditional styling is based on the values in the original report. If the worksheet values are changed and the formulas are recomputed, the styling will not reflect the updated information.

Save Reports as FORMAT XLSX FORMULA

Add the following syntax to your request to take advantage of Excel formulas in your workbook:

```
ON TABLE HOLD FORMAT XLSX FORMULA
```

Generating Native Excel Formulas for Column Totals

The following example illustrates how a column total in a report request is translated to an Excel formula when you use the XLSX FORMULA format. Notice that the formatting of the column total (TYPE=GRANDTOTAL) is retained in the Excel workbook. When you select the total in the report, the equation =SUM(B4:B7) displays in the formula bar, representing the column total as a sum of cell ranges.

```
TABLE FILE GGSales
HEADING
"Projected Return By Region"
" "
SUM DOLLARS AS 'RETURN'
BY REGION AS 'REGION'
ON TABLE COLUMN-TOTAL
ON TABLE HOLD FORMAT XLSX FORMULA
ON TABLE SET STYLE *
TYPE=REPORT, GRID=OFF, FONT='ARIAL', SIZE=9, TITLETEXT=By Region,$
TYPE=TITLE, BACKCOLOR=RGB(102 102 102), COLOR=RGB(255 255 255),$
TYPE=HEADING, SIZE=12, STYLE=BOLD, JUSTIFY=Center,$
TYPE=GRANDTOTAL, BACKCOLOR=RGB(210 210 210), STYLE=BOLD,$
ENDSTYLE
END
```

The output is:

		=SUM(B4:B7)			
	A	B	C	D	E
1	Projected Return By Region				
2					
3	REGION	RETURN			
4	Midwest	11514345			
5	Northeast	11494543			
6	Southeast	11781285			
7	West	11674908			
8	TOTAL	46465081			
9					

FOCUS can translate any total (subtotal, row total, or column total) to an Excel formula. For related information, see [Translation Support for FORMAT XLSX FORMULA](#).

Generating Native Excel Formulas for Row Totals

The following request calculates totals across regions. The row totals are represented as sums of cell ranges.

```
TABLE FILE GGSales
HEADING
"Projected Return Across Region"
" "
SUM BUDDOLLARS AS 'Return' AND
DOLLARS AS 'Balance'
BY ST AS 'STATE'
ACROSS REGION AS 'REGION'
ON REGION ROW-TOTAL AS 'TOTAL'
ON TABLE COLUMN-TOTAL AS 'TOTAL'
ON TABLE HOLD FORMAT XLSX FORMULA
ON TABLE SET STYLE *
TYPE=REPORT, GRID=OFF, FONT='ARIAL',
SIZE=9, TITLETEXT=Across Region,$
TYPE=TITLE, BACKCOLOR=RGB(102 102 102),
COLOR=RGB(255 255 255),$
TYPE=HEADING, SIZE=12, STYLE=BOLD,
JUSTIFY=CENTER,$
TYPE=ACROSSTITLE, STYLE=BOLD,$
TYPE=GRANDTOTAL, BACKCOLOR=RGB(210 210 210),
```

```
STYLE=BOLD,$
ENDSTYLE
END
```

The following output highlights the formula that calculates the row total in cell K16=C16+E16+G16+I16.

K16		=SUM(C16)+SUM(E16)+SUM(G16)+SUM(I16)									
A	B	C	D	E	F	G	H	I	J	K	
Projected Return Across Region											
REGION											
	Midwest		Northeast		Southeast		West		TOTAL		
STATE	Return	Balance	Return	Balance	Return	Balance	Return	Balance	Return	Balance	
CA	7612465	7664223	7612465	7664223	
CT	.	.	3865082	3827274	3865082	3827274	
FL	3911423	3974395	.	.	3911423	3974395	
GA	4267552	4119833	.	.	4267552	4119833	
IL	3951920	4010926	3951920	4010926	
MA	.	.	3818397	3707986	3818397	3707986	
MO	3657014	3767406	3657014	3767406	
NY	.	.	3982645	3959283	3982645	3959283	
TN	3689979	3687057	.	.	.	3687057	
TX	3701253	3736013	3701253	3736013	
WA	4055166	4010685	4055166	4010685	
TOTAL	11310187	11514345	11666124	11494543	11868954	11781285	11667631	11674908	46512896	46465081	

Generating Native Excel Formulas for Calculated Values

The following request totals the columns for BUDDOLLARS and DOLLARS, and calculates the value of a field called PROFIT by subtracting the DOLLARS from the BUDDOLLARS.

The formula for the calculated values is generated by translating the internal form of the FOCUS expression (PROFIT/D12.2MC = BUDDOLLARS - DOLLARS;) into an Excel formula. In this example, the formulas appear in cells B8, C8, and D8.

All fields referenced in the calculation should be displayed in the report for a valid formula to be created using cell references. Otherwise, it may be created using values not in the report. If the fields used in the calculation are not present in the report and there is a subsequent RECOMPUTE, the formula created for the RECOMPUTE will not be correct.

```
TABLE FILE GGSales
ON TABLE SET PAGE-NUM OFF
SUM BUDDOLLARS/I8MC AND DOLLARS/I8MC
COMPUTE PROFIT/D12.2MC = BUDDOLLARS - DOLLARS;
BY REGION
```

```

HEADING
"Profit By Region"
" "
ON TABLE COLUMN-TOTAL
ON TABLE HOLD FORMAT XLSX FORMULA
ON TABLE SET STYLE *
TYPE=REPORT, GRID=OFF, FONT='ARIAL', SIZE=9, TITLETEXT='By Region', $
TYPE=TITLE, BACKCOLOR=RGB(102 102 102), COLOR=RGB(255 255 255), $
TYPE=HEADING, SIZE=12, STYLE=BOLD, JUSTIFY=CENTER, $
TYPE=GRANDTOTAL, BACKCOLOR=RGB(210 210 210), STYLE=BOLD, $
END

```

The following output highlights the formula that calculates for the column total of PROFIT: D8=SUM(D4:D7).

	A	B	C	D
1	Profit By Region			
2				
3	Region	Budget Dollars	Dollar Sales	PROFIT
4	Midwest	\$11,194,373	\$11,400,665	-\$206,292.00
5	Northeast	\$11,576,921	\$11,392,300	\$184,621.00
6	Southeast	\$11,807,971	\$11,710,379	\$97,592.00
7	West	\$11,641,513	\$11,652,946	-\$11,433.00
8	TOTAL	\$46,220,778	\$46,156,290	\$64,488.00
9				

Generating a Native Excel Formula for a Function

The following example illustrates how functions are translated to Excel reports. The function IMOD divides ACCTNUMBER by 1000 and returns the remainder to LAST3_ACCT. The Excel formula corresponds to =TRUNC((MOD(\$C3,(1000)))). TRUNC is used when the answer returned from an equation is being placed into an Integer field, to be sure there are no decimals.

```

TABLE FILE EMPLOYEE
PRINT ACCTNUMBER AS 'Account Number'
COMPUTE LAST3_ACCT/I3L = IMOD(ACCTNUMBER, 1000, LAST3_ACCT);
BY LAST_NAME AS 'Last Name'
BY FIRST_NAME AS 'First Name'

```

```

WHERE (ACCTNUMBER NE 000000000) AND (DEPARTMENT EQ 'MIS');
ON TABLE HOLD FORMAT XLSX FORMULA
ON TABLE SET STYLE *
TYPE=REPORT, GRID=OFF, FONT='ARIAL', SIZE=9,$
TYPE=TITLE, BACKCOLOR=RGB(102 102 102), COLOR=RGB(255 255 255),
STYLE=BOLD,$
END

```

The output is:

	A	B	C	D
1	Last Name	First Name	Account Number	LAST3_ACCT
2	BLACKWOOD	ROSEMARIE	122850108	108
3	CROSS	BARBARA	163800144	144
4	GREENSPAN	MARY	150150302	302
5	JONES	DIANE	040950036	036
6	MCCOY	JOHN	109200096	096
7	SMITH	MARY	027300024	024
8				

Generating a Formula With Recomputed Values

If your report contains a calculated value (generated by the COMPUTE or RECOMPUTE command), all of the fields referenced by the calculated value must be displayed in the report in order for cell references to be included in the formula. If a referenced column is not displayed in the workbook, the data value will be placed in the formula, rather than a cell reference. In the case of RECOMPUTE, the value used may be an incorrect value from the last detail record of the sort break.

Generating a Formula With Recomputed Values

The following request computes the difference (DIFF) by subtracting budgeted dollars from dollar sales. The budgeted dollars field used in the expression is not included in the SUM command. The value of DIFF is recomputed on the region level.

```

TABLE FILE GGSALES
HEADING

```



```

"Profit By Region"
" "
SUM DOLLARS/I8CM
COMPUTE DIFF/I8CM=DOLLARS - BUDDOLLARS;
BY REGION
BY CATEGORY
ON REGION RECOMPUTE
ON TABLE HOLD FORMAT XLSX FORMULA
ON TABLE SET STYLE *
TYPE=REPORT, GRID=OFF, FONT='ARIAL', SIZE=9, TITLETEXT='By Region',$
TYPE=TITLE, BACKCOLOR=RGB(102 102 102), COLOR=RGB(255 255 255),$
TYPE=HEADING, SIZE=12, STYLE=BOLD, JUSTIFY=CENTER,$
TYPE=SUBTOTAL, BACKCOLOR=RGB(210 210 210),$
TYPE=GRANDTOTAL, BACKCOLOR=RGB(166 166 166), STYLE=BOLD,$
END

```

The output shows that the formula is subtracting a data value that is not displayed on the worksheet. It is actually the BUDDOLLARS value from the current hardcoded value, since there is no cell reference.

fx =TRUNC(\$C7 -2887620)				
	A	B	C	D
1	Profit By Region			
2				
3	Region	Category	Dollar Sales	DIFF
4	Midwest	Coffee	\$4,178,513	\$92,481
5		Food	\$4,338,271	\$117,550
6		Gifts	\$2,883,881	-\$3,739
7	*TOTAL Midwest		\$11,400,665	\$8,513,045
8	Northeast	Coffee	\$4,164,017	-\$88,445
9		Food	\$4,379,994	-\$73,913
10		Gifts	\$2,848,289	-\$22,263
11	*TOTAL Northeast		\$11,392,300	\$8,521,748
12	Southeast	Coffee	\$4,415,408	-\$16,021
13		Food	\$4,308,731	-\$100,557
14		Gifts	\$2,986,240	\$18,986
15	*TOTAL Southeast		\$11,710,379	\$8,743,125
16	West	Coffee	\$4,473,517	-\$50,446
17		Food	\$4,202,337	\$19,093
18		Gifts	\$2,977,092	\$42,786
19	*TOTAL West		\$11,652,946	\$8,718,640
20	TOTAL		\$46,156,290	-\$64,488
21				

If you add the BUDDOLLARS column to the request, the formula can be recomputed correctly.

SUM DOLLARS/I8MC BUDDOLLARS/I8MC

The formula generated with the new SUM command contains cell references for both fields used in the calculation.

	A	B	C	D	E
1	Profit By Region				
2					
3	Region	Category	Dollar Sales	Budget Dollars	DIFF
4	Midwest	Coffee	\$4,178,513	\$4,086,032	\$92,481
5		Food	\$4,338,271	\$4,220,721	\$117,550
6		Gifts	\$2,883,881	\$2,887,620	-\$3,739
7	*TOTAL Midwest		\$11,400,665	\$11,194,373	\$206,292
8	Northeast	Coffee	\$4,164,017	\$4,252,462	-\$88,445
9		Food	\$4,379,994	\$4,453,907	-\$73,913
10		Gifts	\$2,848,289	\$2,870,552	-\$22,263
11	*TOTAL Northeast		\$11,392,300	\$11,576,921	-\$184,621
12	Southeast	Coffee	\$4,415,408	\$4,431,429	-\$16,021
13		Food	\$4,308,731	\$4,409,288	-\$100,557
14		Gifts	\$2,986,240	\$2,967,254	\$18,986
15	*TOTAL Southeast		\$11,710,379	\$11,807,971	-\$97,592
16	West	Coffee	\$4,473,517	\$4,523,963	-\$50,446
17		Food	\$4,202,337	\$4,183,244	\$19,093
18		Gifts	\$2,977,092	\$2,934,306	\$42,786
19	*TOTAL West		\$11,652,946	\$11,641,513	\$11,433
20	TOTAL		\$46,156,290	\$46,220,778	-\$64,488
21					

Using XLSX FORMULA With Prefix Operators

XLSX FORMULA output supports prefix operators that are used on summary lines generated by FOCUS commands, such as SUBTOTAL and RECOMPUTE. Where a corresponding formula exists in Excel, these prefix operators are translated into the equivalent Excel summarization formula. The results of prefix operators used directly against retrieved data continue to be passed to Excel as values, not formulas.

The following table identifies the prefix operators supported by XLSX FORMULA when used on summary lines, and the Excel formula equivalent placed in the generated worksheet.

Prefix Operator	Excel Formula Equivalent
SUM.	=SUM()
AVE.	=AVERAGE()
CNT.	=COUNT()
MIN.	=MIN()
MAX.	=MAX()

The following prefix operators are not translated to formulas when used on summary lines in XLSX FORMULA.

- ASQ.
- FST.
- LST.

i Note:

- When using a prefix operator on a field specified directly against retrieved data, there is no space between the prefix operator and the field on which it operates.

For example, in the following aggregating display command, the AVE. prefix operator operates on the DOLLARS field.

```
SUM AVE.DOLLARS
```

- When using a prefix operator on a summary line, you must leave a space between the prefix operator and the aggregated field on which it operates.

In the following summary command, the MAX. prefix operator operates on the DOLLARS field at the REGION sort break. Note the required blank space between the prefix operator and the field name.

```
ON REGION RECOMPUTE MAX. DOLLARS
```

Using a Summary Prefix Operator With FORMAT XLSX FORMULA

In the following request against the GGSales data source, the RECOMPUTE command for the REGION sort field calculates the maximum of the aggregated DOLLARS field and the minimum of the aggregated BUDDOLLARS field.

```
TABLE FILE GGSales
SUM UNITS DOLLARS/I8MC BUDDOLLARS/I8MC
AND COMPUTE DIFF/I8MC= DOLLARS-BUDDOLLARS;
BY REGION
BY CATEGORY
WHERE CATEGORY EQ 'Food' OR 'Coffee'
WHERE REGION EQ 'West' OR 'Midwest'
ON REGION RECOMPUTE MAX. DOLLARS MIN. BUDDOLLARS DIFF
ON TABLE HOLD FORMAT XLSX FORMULA
ON TABLE SET STYLE *
TYPE=REPORT, GRID=OFF, FONT='ARIAL', SIZE=9,$
TYPE=TITLE, BACKCOLOR=RGB(102 102 102), COLOR=RGB(255 255 255),$
TYPE=SUBTOTAL, BACKCOLOR=RGB(210 210 210),$
TYPE=GRANDTOTAL, BACKCOLOR=RGB(166 166 166), STYLE=BOLD,$
END
```

In the output, shown in the following image, the cell that represents the recomputed DOLLARS for the Midwest region has been generated as the following formula.

```
=MIN(E2:E3)
```

	A	B	C	D	E	F
1	Region	Category	Unit Sales	Dollar Sales	Budget Dollars	DIFF/I10
2	Midwest	Coffee	332777	\$4,178,513	\$4,086,032	\$92,481
3		Food	341414	\$4,338,271	\$4,220,721	\$117,550
4	*TOTAL Midwest			\$4,338,271	\$4,086,032	\$252,239
5	West	Coffee	356763	\$4,473,517	\$4,523,963	-\$50,446
6		Food	340234	\$4,202,337	\$4,183,244	\$19,093
7	*TOTAL West			\$4,473,517	\$4,183,244	\$290,273
8	TOTAL			\$4,473,517	\$4,086,032	\$387,485
9						

Using a Prefix Operator on a Display Command With FORMAT XLSX FORMULA

In the following request against the GGSales data source, the CNT., AVE., and PCT. Prefix operators are used in the SUM display command.

```
TABLE FILE GGSales
SUM UNITS
CNT.UNITS
AVE.UNITS
PCT.UNITS
BY REGION
BY ST
ON TABLE HOLD FORMAT XLSX FORMULA
END
```

The output shows that the prefix operators were not passed to Excel as formulas. They were passed as data values.

		fx 360				
	A	B	C	D	E	F
			Unit Sales	Unit Sales	AVE	PCT
1	Region	State	Unit Sales	COUNT	Unit Sales	Unit Sales
2	Midwest	IL	307581	360	854	8
3		MO	297727	359	829	8
4		TX	299737	360	832	8
5	Northeast	CT	302440	360	840	8
6		MA	301909	360	838	8
7		NY	312326	360	867	8
8	Southeast	FL	310302	360	861	8
9		GA	330283	360	917	8
10		TN	294647	360	818	7
11	West	CA	610570	719	849	16
12		WA	321469	359	895	8
13						

NODATA With Formulas

Support for full Excel functionality requires that only valid numeric values are placed into cells that will be used for formula references.

The null value (NODATA='') is supported for calculations. When cells containing the default NODATA symbol (.) are used in a formula, they will cause a formula error.

For example:

```

SET NODATA=''
TABLE FILE GGSALES
SUM DOLLARS/D12CM UNITS/D12C AND ROW-TOTAL AND COLUMN-TOTAL
COMPUTE REVENUE/D12CM=DOLLARS*UNITS; AS 'Revenue'
BY LOWEST GGSALES.SALES01.CATEGORY
BY GGSALES.SALES01.PRODUCT
ACROSS REGION
ON TABLE HOLD FORMAT XLSX FORMULA
END
-----
SET NODATA=''
DEFINE FILE GGSALES
DOLLARMOD/D12CM MISSING ON=IF REGION GT 'V' THEN MISSING ELSE DOLLAR;
END
TABLE FILE GGSALES
SUM DOLLARMOD/D12CM UNITS/D12C AND ROW-TOTAL AND COLUMN-TOTAL
COMPUTE REVENUE/D12CM=DOLLARMOD*UNITS; AS 'Revenue'
BY REGION
BY LOWEST GGSALES.SALES01.CATEGORY
BY GGSALES.SALES01.PRODUCT
ON TABLE SET PAGE-NUM NOLEAD
ON TABLE HOLD FORMAT XLSX FORMULA
END

```

Usage Notes for XLSX With Formulas

- Formulas are defined within a single worksheet. They will not be assigned across worksheets.

Controlling Column Width and Wrapping in XLSX Report Output

- Column width and data wrapping can be controlled in an Excel worksheet when

using `FORMAT XLSX`.

- To size the column without wrapping and define the exact size width, use `SQUEEZE=ON`. If a data value is wider than the specified width of the column, a portion of the data will be hidden from view, but fully visible in the formula bar. You can adjust the column width in Excel after the worksheet has been generated.
- The default behavior is for all data to wrap within the defined column width. You can also specify the exact width of a column using `WRAP=ON`.
- `WRAP` is not supported for Date format fields.

Set Column Width in XLSX Report Output

```
TYPE=REPORT, [COLUMN=column,] SQUEEZE=value,$
```

where:

column

Identifies a particular column. If `COLUMN` is not included in the declaration, default `SQUEEZE` behavior is applied to the entire report.

value

Is one of the following:

ON

Automatically sizes the columns based on the largest data value in the column. This is the default behavior.

OFF

Sizes the columns based on the maximum size defined for the field in the Master File or Define.

n

Represents a specific numeric value for which the column width can be set. The value represents the measure specified with the `UNITS` parameter (the default is inches). This is the most commonly used `SQUEEZE` setting in an XLSX report. This turns off data wrapping.

i Note:

- SQUEEZE can be applied to the entire report by using the ON TABLE SET SQUEEZE ON command.
- SQUEEZE is not supported for columns created with the OVER phrase or with TABLEF.

Wrap Data in XLSX Report Output

```
TYPE=REPORT, [COLUMN=column,] WRAP=value,$
```

where:

column

Designates a particular column to apply wrapping behavior to. If COLUMN is not included in the declaration, wrapping will be applied to the entire report.

value

Is one of the following:

ON

Turns on data wrapping. ON is the default value. With this setting, the column width is determined by the client (Excel). Data wraps if it exceeds the width of the column and the row height expands to meet the new height of the wrapped data.

OFF

Turns off data wrapping. Data will not wrap in any cell in the column.

n

Represents a specific numeric value that the column width can be set to. The value represents the measure specified with the UNITS parameter (the default is inches).

This setting implies ON. However, the column width is set to the specified width unless the data is wider than the column width, in which case, wrapping will occur as for ON.

i Note: WRAP is not supported for Date format fields.

Controlling Column Width and Wrapping in XLSX Report Output

The following example illustrates how to turn on and turn off data wrapping in a column and how to set the column width for a particular column. The UNITS in this example are set to inches (the default).

```
DEFINE FILE GGSales
PROFIT/D14.3 = BUDDOLLARS-DOLLARS;
DESCRIPTION/A80 = 'Subtract Total Sales Quota from Reported Sales to
calculate profit.';
END
```

```
TABLE FILE GGSales
SUM
DESCRIPTION AS 'DEFAULT'
DESCRIPTION AS 'WRAP = 2'
DESCRIPTION AS 'WRAP = OFF'
DESCRIPTION AS 'SQUEEZE = 1.5'
PROFIT
BY REGION NOPRINT
ON TABLE HOLD FORMAT XLSX
ON TABLE SET STYLE *
TYPE=REPORT, COLUMN=DESCRIPTION(2), WRAP=2,$
TYPE=REPORT, COLUMN=DESCRIPTION(3), WRAP=OFF,$
TYPE=REPORT, COLUMN=DESCRIPTION(4), SQUEEZE=1.5,$
END
```

where:

1. The column titled "DEFAULT" illustrates the default column width and wrapping behavior.
2. The column titled "WRAP=2" sets the column width to 2 inches with data wrapping on.
3. The column titled "WRAP=OFF" turns off data wrapping for that column.

- The column titled "SQUEEZE=1.5" sets the column width to 1.5 inches with data wrapping off.

Since the output spans two pages, the output is shown below in two separate images.

The following output displays the different behavior for the "DEFAULT" and "WRAP=2" columns.

A	B
DEFAULT	WRAP=2
Subtract Total Sales Quota from Reported Sales to calculate profit.	Subtract Total Sales Quota from Reported Sales to calculate profit.
Subtract Total Sales Quota from Reported Sales to calculate profit.	Subtract Total Sales Quota from Reported Sales to calculate profit.
Subtract Total Sales Quota from Reported Sales to calculate profit.	Subtract Total Sales Quota from Reported Sales to calculate profit.
Subtract Total Sales Quota from Reported Sales to calculate profit.	Subtract Total Sales Quota from Reported Sales to calculate profit.

The following output displays the output for the "WRAP=OFF" and "SQUEEZE=1.5" columns.

Subtract Total Sales Quota from Reported Sales to calculate profit.		
C	D	E
WRAP=OFF	SQUEEZE=1.5	PROFIT
Subtract Total Sales Quota from Reported Sales to calculate profit.	Subtract Total Sales Quota	-206,292.000
Subtract Total Sales Quota from Reported Sales to calculate profit.	Subtract Total Sales Quota	184,621.000
Subtract Total Sales Quota from Reported Sales to calculate profit.	Subtract Total Sales Quota	97,592.000
Subtract Total Sales Quota from Reported Sales to calculate profit.	Subtract Total Sales Quota	-11,433.000

Preserving Leading and Internal Blanks in Report Output

The SHOWBLANKS command allows you to preserve leading blanks in data cells and headings in XLSX reports. In XLSX, internal blanks will always be retained, but leading and trailing blanks in data fields are removed. You can use the SHOWBLANKS command to retain leading and trailing blanks.

Since XLSX is not HTML-based like EXL2K, setting SHOWBLANKS OFF will not affect internal blanks. By default, EXL2K reduces all embedded blanks to a single blank, while XLSX

preserves all embedded blanks. This difference in spacing may cause additional differences in how fields wrap within a cell.

SET SHOWBLANKS	XLSX (not HTML-based)	EXL2K (HTML-based)
SET SHOWBLANKS = ON	Leading and embedded blanks are preserved.	Leading and embedded blanks are preserved.
SET SHOWBLANKS = OFF	Leading blanks are removed, but embedded blanks are respected.	Leading and embedded blanks are removed.

Blanks are handled differently in headings:

- By default, in standard headings containing multiple items (without HEADALIGN=BODY), items are concatenated together into a single text object. All blanks are retained.
- Fields placed in headings with HEADALIGN=BODY behave the same way as data elements.
- Variables placed in headings with HEADALIGN=BODY respect all leading, embedded blanks, and trailing blanks. With SHOWBLANKS=OFF, only embedded blanks are retained. With SHOWBLANKS=ON all leading, embedded, and trailing blanks are retained.

Preserve Leading and Internal Blanks in XLSX Reports

In a FOCEXEC or in a profile, use the following syntax:

```
SET SHOWBLANKS = {OFF|ON}
```

In a request, use the following syntax

```
ON TABLE SET SHOWBLANKS {OFF|ON}
```

where:

OFF

Removes leading blanks and preserves internal blanks in XLSX report output. OFF is the default value.

ON

Preserves leading and internal blanks in XLSX report output. Also preserves trailing blanks in heading, subheading, footing, and subfooting lines that use the default heading or footing alignment.

Preserving Leading and Internal Blanks in XLSX Report Output

The following request creates a variable called SHOWVAR that contains leading, internal, and trailing blanks.

```
SET SHOWBLANKS = OFF

-SET &SHOWVAR= ' AB C ';
DEFINE FILE CAR
SHOWFIELD/A9 = ' AB C ';
END

TABLE FILE CAR
ON TABLE SUBHEAD
"SHOWBLANKS OFF"
"/&SHOWVAR/"
""
HEADING
"In Heading:"
"SHOWVAR<+0>&SHOWVAR"
"SHOWFIELD<+0><SHOWFIELD"
""
"In DATA":
PRINT SHOWFIELD
BY COUNTRY
WHERE RECORDLIMIT EQ 1;
```

```

ON TABLE HOLD FORMAT XLSX
ON TABLE SET STYLE *
HEADALIGN=BODY, SQUEEZE=ON, $
TYPE=TABHEADING, COLSPAN=2, $
END

```

The following outputs show the differences in XLSX generated using SET SHOWBLANKS = OFF and SET SHOWBLANKS = ON.

SET SHOWBLANKS = OFF with HEADALIGN=BODY (no leading blanks or trailing blanks)

B5		AB C		
	A	B	C	D
1	SHOWBLANKS OFF			
2	/ AB C /			
3				
4	In Heading:			
5	SHOWVAR	AB C		
6	SHOWFIELD	AB C		
7				
8	In DATA			
9	COUNTRY	SHOWFIELD		
10	ENGLAND	AB C		

SET SHOWBLANKS = OFF without HEADALIGN=BODY (preserved blanks and concatenated heading items)

A5		SHOWVAR AB C			
	A	B	C	D	E
1	SHOWBLANKS OFF				
2	/ AB C /				
3					
4	In Heading:				
5	SHOWVAR	AB C			
6	SHOWFIELD	AB C			
7					
8	In DATA				
9	COUNTRY	SHOWFIELD			
10	ENGLAND	AB C			

SET SHOWBLANKS = ON with HEADALIGN=BODY (leading blanks and trailing blanks)

B5		AB C		
	A	B	C	D
1	SHOWBLANKS ON			
2	/ AB C /			
3				
4	In Heading:			
5	SHOWVAR	AB C		
6	SHOWFIELD	AB C		
7				
8	In DATA			
9	COUNTRY	SHOWFIELD		
10	ENGLAND	AB C		

SET SHOWBLANKS = ON without HEADALIGN=BODY (preserved blanks and concatenated heading items)

A5		SHOWVAR AB C			
	A	B	C	D	E
1	SHOWBLANKS ON				
2	/ AB C /				
3					
4	In Heading:				
5	SHOWVAR	AB C			
6	SHOWFIELD	AB C			
7					
8	In DATA				
9	COUNTRY	SHOWFIELD			
10	ENGLAND	AB C			

Excel Page Settings

Excel page settings for the XLSX workbook default to the FOCUS standards:

- Orientation: Portrait
- Page Size: Letter
- .75 inches (Excel default)
- .75 inches (Excel default)

To customize these page settings, turn the XLSXPAGESETS attribute ON and define individual attributes.

If XLSXPAGESETS is turned on, but the page margin attributes are not defined within the procedure, the values will be set to the FOCUS default of .25 inches.

Define Excel Page Settings

```
[TYPE=REPORT,] XLSXPAGESETS={ON|OFF} [,PAGESIZE={pagesize|LETTER}]  
[,ORIENTATION={PORTRAIT|LANDSCAPE}] [,TOPMARGIN=n] [,BOTTOMMARGIN=m], $
```

where:

XLSXPAGESETS={ON|OFF}

ON causes the page settings defined in the FOCUS request to be applied to the Excel worksheet page settings. OFF retains the default page settings defined in the standard Excel workbook. OFF is the default value.

n

Defines the top margin for the worksheet in the units identified by the UNITS parameter (inches, by default). The default value is .25.

m

Defines the bottom margin for the worksheet in the units identified by the UNITS parameter (inches, by default). The default value is .25.

pagesize

Is one of the PAGESIZE values supported in a FOCUS StyleSheet. LETTER is the default page size.

PORTRAIT|LANDSCAPE

PORTRAIT displays the report across the narrower dimension of a vertical page, producing a page that is longer than it is wide. PORTRAIT is the default value.

LANDSCAPE displays the report across the wider dimension of a horizontal page, producing a page that is wider than it is long.

Inserting Text and Images Into XLSX Workbook Headers and Footers

FOCUS supports the insertion of text and images into Excel headers and footers and the definition of key page settings to support the placement of text and images in relationship to the overall worksheet and the Excel generated page breaks. This access to the Excel page functionality is designed to enhance overall usability of the worksheets for users who will be printing these reports. Page settings including orientation, page size, and page margins will directly affect the layout of each Excel page based on values defined within the FOCEXEC. Images and text can be included on headers and footers on every printed page, on the first page of the report only, or only on all subsequent pages. The FOCUS headings and footings continue to display within the worksheet. With this feature, FOCUS can insert logos to be printed once at the top of a report and watermark images that need to be displayed on every printed page.

Insert Text and Images Into XLSX Workbook Headers and Footers

To place images in XLSX Workbook headers and footers, the syntax is:

```
TYPE={PAGEHEADER|PAGEFOOTER},OBJECT=IMAGE,
IMAGE=imagename, JUSTIFY={LEFT|CENTER|RIGHT}
[,DISPLAYON={FIRST|NOT-FIRST}] [,SIZE=(wh)],$
```

To place text in XLSX Workbook headers and footers, the syntax is:

```
TYPE={PAGEHEADER|PAGEFOOTER},OBJECT=STRING,
TEXT=text, JUSTIFY={LEFT|CENTER|RIGHT}
[,DISPLAYON={FIRST|NOT-FIRST}] , $
```

where:

PAGEHEADER

Places the text or image in the worksheet header.

PAGEFOOTER

Places the text or image in the worksheet footer.

imagename

Is the name of a valid image file to be placed in the header or footer. The image must be located in the defined application path or allocated to a DDNAME accessible to FOCUS. The image types supported are GIF and JPEG.

text

Is the text to be placed in the header or footer.

JUSTIFY={LEFT|CENTER|RIGHT}

Identifies the area in the header or footer to contain the text or image and the justification or placement within that defined area.

DISPLAYON

Defines whether the text or image should be placed on the first page only or on all pages except the first. Omit this attribute to place the text or image on all pages.

Valid values are:

- FIRST places the text or image only on the first page.
- NOT-FIRST places the text or image on every page, except the first page.

SIZE=(wh)

Is the size of the image. By default, an image is added at its original size.

w is the width of the image, expressed in the unit of measurement specified by the UNITS parameter.

h is the height of the image, expressed in the unit of measurement specified by the UNITS parameter.

Inserting Images in Excel Headers and Footers and Defining Page Settings

The following request against the GGSales data source places the image gglogo.gif on the left header area of the first page and the right header area of every subsequent page of the

resulting worksheet. It places the same image in the center area of the footer on every page. The image file is in a data set allocated to DDNAME GIF.

```
SET EXCELSERVURL = LOCAL
TABLE FILE GGSales
SUM DOLLARS UNITS BUDDOLLARS BUDUNITS
BY REGION
BY ST
BY CATEGORY
BY PRODUCT
ON TABLE SET BYDISPLAY ON
ON TABLE HOLD AS XLSXHD1 FORMAT XLSX
ON TABLE SET STYLE *
FONT=ARIAL,SIZE=12,
XLSXPAGESETS=ON, TOPMARGIN=1, BOTTOMMARGIN=1, ORIENTATION=LANDSCAPE,
PAGESIZE=LETTER, $
TYPE=TITLE, COLOR=WHITE, BACKCOLOR=GREY, $
TYPE=PAGEHEADER, OBJECT=IMAGE, JUSTIFY=LEFT, IMAGE=GGLOGO.GIF,
DISPLAYON=FIRST, $
TYPE=PAGEHEADER, OBJECT=IMAGE, JUSTIFY=RIGHT, IMAGE=GGLOGO.GIF,
DISPLAYON=NOT-FIRST, $
TYPE=PAGEFOOTER, OBJECT=IMAGE, JUSTIFY=CENTER,
IMAGE=GGLOGO.GIF, $
END
```

The first page of output has the image in the left area of the header and in the center area of the footer, as shown in the following image.



Region	State	Category	Product	Dollar Sales	Unit Sales	Budget Dollars	Budget Units
Midwest	IL	Coffee	Espresso	420439	32237	401477	32416
Midwest	IL	Coffee	Latte	978340	77344	964787	79015
Midwest	IL	Food	Biscotti	417469	32321	422397	32941
Midwest	IL	Food	Croissant	549366	43300	528255	43271
Midwest	IL	Food	Scone	595069	45355	567231	45091
Midwest	IL	Gifts	Coffee Grinder	280760	22948	289747	23011
Midwest	IL	Gifts	Coffee Pot	204828	15785	208255	16035
Midwest	IL	Gifts	Mug	376754	30157	388612	30881
Midwest	IL	Gifts	Thermos	187901	14651	181159	14137
Midwest	MO	Coffee	Espresso	419143	32596	416875	32787
Midwest	MO	Coffee	Latte	966981	77347	921336	77141
Midwest	MO	Food	Biscotti	368077	29188	360403	28764
Midwest	MO	Food	Croissant	619991	49451	602785	50131
Midwest	MO	Food	Scone	481953	37602	478691	36573
Midwest	MO	Gifts	Coffee Grinder	181570	14614	171501	14779
Midwest	MO	Gifts	Coffee Pot	190153	14807	191451	14970
Midwest	MO	Gifts	Mug	343852	27040	324488	26837
Midwest	MO	Gifts	Thermos	195686	15592	189484	15903
Midwest	TX	Coffee	Espresso	455365	36321	439880	36666
Midwest	TX	Coffee	Latte	938245	76932	941677	77501
Midwest	TX	Food	Biscotti	363438	28904	340295	28391
Midwest	TX	Food	Croissant	590722	47130	590005	47228
Midwest	TX	Food	Scone	418398	33170	398437	32112
Midwest	TX	Gifts	Coffee Grinder	204292	16440	200241	16625
Midwest	TX	Gifts	Coffee Pot	204897	16564	214301	16774
Midwest	TX	Gifts	Mug	366337	29521	383050	29374
Midwest	TX	Gifts	Thermos	194319	16344	193367	16779
Northeast	CT	Coffee	Capuccino	158995	12386	141574	11098
Northeast	CT	Coffee	Espresso	279373	22482	299854	23676
Northeast	CT	Coffee	Latte	926052	74623	953855	74427
Northeast	CT	Food	Biscotti	634580	49229	620381	49144
Northeast	CT	Food	Croissant	551489	45847	580168	46335



The second page of output has the image in the right area of the header and in the center area of the footer, as shown in the following image.



Northeast	CT	Food	Scone	283874	22378	269221	21038
Northeast	CT	Gifts	Coffee Grinder	169908	13691	159620	13117
Northeast	CT	Gifts	Coffee Pot	208209	15523	197051	15190
Northeast	CT	Gifts	Mug	392967	31728	424333	32415
Northeast	CT	Gifts	Thermos	221827	17568	219025	17667
Northeast	MA	Coffee	Capuccino	174344	15358	192747	15672
Northeast	MA	Coffee	Espresso	248356	19698	254310	19888
Northeast	MA	Coffee	Latte	917737	74572	941438	73874
Northeast	MA	Food	Biscotti	570391	47064	616766	48246
Northeast	MA	Food	Croissant	497234	41029	519322	41351
Northeast	MA	Food	Scone	332486	25363	312004	23774
Northeast	MA	Gifts	Coffee Grinder	177940	14382	187686	15384
Northeast	MA	Gifts	Coffee Pot	184119	15349	184071	15171
Northeast	MA	Gifts	Mug	401944	32360	401617	31324
Northeast	MA	Gifts	Thermos	203435	16734	208436	16921
Northeast	NY	Coffee	Capuccino	208756	17041	227170	17662
Northeast	NY	Coffee	Espresso	322378	25947	318738	26212
Northeast	NY	Coffee	Latte	965066	77048	964733	76528
Northeast	NY	Food	Biscotti	662237	53500	658781	51808
Northeast	NY	Food	Croissant	622095	50518	640032	50178
Northeast	NY	Food	Scone	290811	22991	284478	23603
Northeast	NY	Gifts	Coffee Grinder	161352	12904	164336	12796
Northeast	NY	Gifts	Coffee Pot	198452	15313	192227	15043
Northeast	NY	Gifts	Mug	349300	27409	344364	26801
Northeast	NY	Gifts	Thermos	178836	14568	187786	15179
Southeast	FL	Coffee	Capuccino	317027	24143	285194	23092
Southeast	FL	Coffee	Espresso	256539	19730	236531	18690
Southeast	FL	Coffee	Latte	889887	71123	886465	72975
Southeast	FL	Food	Biscotti	511597	40606	516984	41242
Southeast	FL	Food	Croissant	602076	50175	644884	51437
Southeast	FL	Food	Scone	311836	24543	299547	24576
Southeast	FL	Gifts	Coffee Grinder	268384	20441	247445	20340
Southeast	FL	Gifts	Coffee Pot	212057	16145	215467	16470



Inserting Text and Images in Excel Report Output

The following request against the GGSALES data source places the gglogo.gif image in the left header area and text in the center header area of the worksheet. It also places the image in the left footer area and text in the center footer area. The image is in a data set allocated to DDNAME GIF.

```
SET EXCELSERVURL=LOCAL
TABLE FILE GGSALES
SUM DOLLARS UNITS BUDDOLLARS BUDUNITS
BY REGION
BY ST
BY CATEGORY
BY PRODUCT
WHERE REGION EQ 'West'
ON TABLE SET BYDISPLAY ON
ON TABLE HOLD AS XLSXHD2 FORMAT XLSX
ON TABLE SET STYLE *
FONT=ARIAL,SIZE=12,
XLSXPAGESETS=ON,TOPMARGIN=1,BOTTOMMARGIN=1,ORIENTATION=LANDSCAPE,
PAGESIZE=LETTER,$
TYPE=TITLE, COLOR=WHITE, BACKCOLOR=GREY,$
TYPE=PAGEHEADER, OBJECT=IMAGE, JUSTIFY=LEFT, IMAGE=GGLOGO.GIF,$
TYPE=PAGEHEADER, OBJECT=STRING, JUSTIFY=CENTER,
  TEXT=Budget Sales for West Region, FONT=ARIAL, SIZE=14,$
TYPE=PAGEFOOTER, OBJECT=IMAGE, JUSTIFY=LEFT, IMAGE=GGLOGO.GIF,$
TYPE=PAGEFOOTER, OBJECT=STRING, JUSTIFY=CENTER,
  TEXT=End of Report, FONT=ARIAL, SIZE=12,$
ENDSTYLE
END
```

The output is shown in the following image.

```
SET XLSXPAGEBRKIGNORE {OFF|ON}
```

where:

OFF

Synchronizes FOCUS page breaks with Excel page breaks in format XLSX report output. This is the default value.

ON

Does not synchronize FOCUS page breaks with Excel page breaks in format XLSX report output. This value conforms to behavior in prior releases.

Synchronizing FOCUS Page Breaks With Excel Page Breaks in Format XLSX Report Output

The following request generates format XLSX report output with WebFOCUS page breaks that are inserted using the BY REGION PAGE-BREAK phrase.

```
SET XLSXPAGEBRKIGNORE=OFF
TABLE FILE GGSALES
"HEADING Regions : <REGION"
SUM UNITS DOLLARS
BY REGION PAGE-BREAK
BY DATE
ACROSS CATEGORY
WHERE CITY LE 'Memphis'
ON TABLE SET EXCELSERVURL LOCAL
ON TABLE HOLD AS XLSXPG1 FORMAT XLSX
ON TABLE SET STYLE *
XLSXPAGESETS=ON,
TOPMARGIN=1.25, BOTTOMMARGIN=1, ORIENTATION=LANDSCAPE, $
TYPE=REPORT, FONT=ARIAL, SIZE=9, $
TYPE=ACROSSTITLE, STYLE=BOLD, SIZE=10, $
TYPE=ACROSSVALUE, STYLE=BOLD, SIZE=10, $
TYPE=TITLE, STYLE=BOLD, SIZE=10, $
ENDSTYLE
END
```

Partial output is shown in the following image, using the Excel Page Break Preview view. XLSXPAGEBRKIGNORE is set to OFF (the default value). The default Excel page breaks are synchronized with the page breaks specified in the WebFOCUS request.

HEADING Regions : Midwest							
Region	Date	Coffee		Food		Gifts	
		Unit Sales	Dollar	Unit Sales	Dollar	Unit Sales	Dollar
Midwest	1936/01/01	6531	81602	3167	115633	7061	84387
	1936/02/01	8405	110197	3627	115910	6781	87148
	1936/03/01	10009	126459	3220	115376	7610	104120
	1936/04/01	5558	72712	7892	39820	6633	80624
	1936/05/01	3355	127929	3168	119401	7218	82509
	1936/06/01	13762	117687	12058	155633	5827	73346
	1936/07/01	6626	84121	8782	132130	6891	86735
	1936/08/01	9125	110957	8916	113884	7368	90011
	1936/09/01	11571	141458	3391	116130	4890	68174
	1936/10/01	3534	124045	3918	129345	5898	76308
	1936/11/01	3331	111134	3976	112107	6844	85061
	1936/12/01	10032	118436	19417	137812	5689	63267
	1937/01/01	10051	137215	10481	129142	4429	53716
	1937/02/01	8273	102490	6321	79240	7140	83851
	1937/03/01	9170	112160	8235	106570	6716	81089
	1937/04/01	9140	113469	10634	14145	6796	87749
	1937/05/01	10122	129448	7977	102583	5639	75124
	1937/06/01	7219	87517	7100	31705	5200	59999
	1937/07/01	12136	146989	10936	137918	5987	68755
	1937/08/01	8075	103510	10369	131924	6198	75038
	1937/09/01	10300	125846	11033	140761	6321	75639
	1937/10/01	10421	129220	10040	124644	5841	71504
	1937/11/01	7452	90677	8186	105241	8267	95248
	1937/12/01	3926	124049	11308	139691	11437	150518
	3932/12/02	.	.	2908	39057	.	.
	1900/12/31	3609	47468

HEADING Regions : Northeast							
Region	Date	Coffee		Food		Gifts	
		Unit Sales	Dollar	Unit Sales	Dollar	Unit Sales	Dollar
Northeast	1936/01/01	5640	70645	3868	42752	3195	35862
	1936/02/01	5458	69192	5165	58795	3960	43950
	1936/03/01	5627	71216	4218	48509	3405	40296
	1936/04/01	5060	67037	6218	76260	2432	29529
	1936/05/01	2090	27487	5777	79075	3651	46815
	1936/06/01	4882	53037	5860	74237	2557	29915
	1936/07/01	6147	80630	6081	76199	3388	44646
	1936/08/01	3741	42215	4630	59948	3536	43371
	1936/09/01	4387	47351	5275	66469	2680	34064
	1936/10/01	4754	53481	3977	56265	2918	34147
	1936/11/01	6087	71142	4406	54883	3303	42289
	1936/12/01	6843	83284	4547	54915	3342	41562
	1937/01/01	4933	64078	3722	47657	3144	37372
	1937/02/01	3030	36627	4493	57128	3553	42484
	1937/03/01	1944	23475	4378	53408	2929	36596
	1937/04/01	5947	64976	4566	49641	2890	32902
	1937/05/01	4264	54002	3327	38047	5101	63993
	1937/06/01	5319	63699	4725	54663	3536	40376
	1937/07/01	4620	57414	5229	68417	3721	43458
	1937/08/01	3681	41876	4129	51299	1532	18102
	1937/09/01	3446	46446	5445	62675	3550	44920
	1937/10/01	4476	51433	4544	60315	3622	51199
	1937/11/01	3785	45193	5343	69002	3209	35275
	1937/12/01	3537	42495	3533	39552	3671	48295

Changing the value of the XLSXPAGEBRKIGNORE parameter to ON produces the following partial output, in which the Excel page breaks are not synchronized with the FOCUS page breaks.

HEADING Region: Midwest								
Region	Date	Category			Gifts			
		Unit	Dollar	Unit	Dollar	Unit	Dollar	
Midwest	1996/01/01	6591	81602	9167	115693	7061	84387	
	1996/02/01	8405	110197	9627	115910	6781	87148	
	1996/03/01	10009	126459	9220	115976	7610	104120	
	1996/04/01	5558	72712	7892	99820	6633	80624	
	1996/05/01	9355	127929	9168	119401	7218	82509	
	1996/06/01	13762	177687	12058	155633	5827	73946	
	1996/07/01	6626	84121	9782	132130	6891	86735	
	1996/08/01	9125	110957	8916	113884	7268	90011	
	1996/09/01	11571	141458	9391	116130	4890	68174	
	1996/10/01	9534	124045	9918	129945	5898	76308	
	1996/11/01	9391	111134	5976	112107	6844	8506	
	1996/12/01	10022	119498	10417	137812	5689	69367	
	1997/01/01	10051	137215	10481	129142	4429	53716	
	1997/02/01	8273	102490	8321	79240	7140	8385	
	1997/03/01	9170	112160	8295	106570	6776	87088	
	1997/04/01	9740	113488	10694	141545	6796	87749	
	1997/05/01	10122	129448	7977	102583	5699	75124	
	1997/06/01	7219	87517	7100	91705	5200	59999	
	1997/07/01	12136	148989	10936	137918	5987	68755	
	1997/08/01	8075	103510	10369	131924	6198	75038	
	1997/09/01	10300	125846	11033	140761	6321	75639	
	1997/10/01	10421	129220	10040	124644	5841	71504	
	1997/11/01	7452	90677	8186	105241	8267	95248	
	1997/12/01	9926	124049	11308	139691	11437	150518	
	1998/12/02			2908	39057			
	1900/12/31					3609	47468	
HEADING Region: Northeast								
Region	Date	Category			Gifts			
		Unit	Dollar	Unit	Dollar	Unit	Dollar	
Northeast	1996/01/01	5640	70645	3868	42752	3195	35862	
	1996/02/01	5458	64192	5165	52795	3960	49950	
	1996/03/01	5627	71216	4218	48509	3405	40296	
	1996/04/01	5060	67037	6218	76260	2432	29529	
	1996/05/01	2090	27487	5777	79075	3651	46815	
	1996/06/01	4882	59037	5860	74237	2857	29915	
	1996/07/01	6147	80630	6081	76199	3388	44646	
	1996/08/01	3741	42215	4620	59948	3936	4337	
	1996/09/01	4307	47351	5275	66469	2680	34084	
	1996/10/01	4754	59487	3977	56265	2918	34147	
	1996/11/01	6097	71142	4406	54883	3303	42288	
	1996/12/01	6843	83284	4547	54915	3342	41562	
	1997/01/01	4933	64078	3722	47657	3144	37372	
	1997/02/01	3030	36627	4493	57128	3553	42484	
	1997/03/01	1944	23475	4378	53408	2929	36596	
	1997/04/01	5947	64976	4566	49641	2890	32902	
	1997/05/01	4264	54002	3327	38047	5101	63993	
	1997/06/01	5319	63699	4725	54663	3534	40376	
	1997/07/01	4620	57414	5229	68417	3721	43488	
	1997/08/01	3681	48386	4129	51299	1832	18102	
	1997/09/01	3446	46446	5045	62675	3950	44920	
	1997/10/01	4476	51432	4544	60315	3622	51199	
	1997/11/01	3785	45193	5343	69002	3209	35275	
	1997/12/01	3537	42495	3533	39552	3671	48295	
HEADING Region: Southeast								
Region	Date	Category			Gifts			
		Unit	Dollar	Unit	Dollar	Unit	Dollar	
Southeast	1996/01/01	6966	88918	9643	118107	7209	94507	
	1996/02/01	7912	93609	10573	132460	5774	69596	
	1996/03/01	11317	147751	9027	119034	5780	72420	
	1996/04/01	9416	122340	11078	136894	6733	83147	
	1996/05/01	8873	113173	9718	118244	6805	89074	
	1996/06/01	8976	103181	7411	93361	4248	52292	
	1996/07/01	9087	113889	11413	132714	6647	88214	
	1996/08/01	10549	136673	8681	93857	6509	87375	
	1996/09/01	8714	116968	8822	109615	5110	65778	
	1996/10/01	9632	120356	10488	126342	6053	75558	
	1996/11/01	6845	86336	4374	46488	3683	45468	

Adding an Image to a Report

FOCUS supports the placement of images within each area or node of the report on the worksheet. An image, such as a logo, gives corporate identity to a report, or provides visual appeal. Data specific images can be placed in headers, footers, and data columns to provide additional clarity and style.

The image must reside in an APP or a sequential file, or be a member in a data set. If the image is not in an APP, the sequential file or member must be allocated, and you can use the DDNAME or file name as the image name.. If the file is not on the search path, supply the full path name.

Inserting Images Into Excel XLSX Reports

Images can be placed in any available FOCUS reporting node or element of a worksheet. Supported image formats include .gif and .jpg.

Usage Considerations

- All images will be placed in the top-left corner of the first cell of the defined area, based on the top and left gap. Defined explicit positioning and justification have not been implemented yet.
- Standard page setting keywords can be used in conjunction with XLSXPAGESETS to control the page layout in standard reports (not compound).
- Images placed within a report cell in a row or column are anchored to the top-left corner of the cell. The cell is automatically sized to the height and width to fit the largest image (SQUEEZE=ON).
- Additional lines may need to be added within a heading, footing, subhead, or subfoot to accommodate the placement of the image.

Insert Images Into FOCUS Report Elements in XLSX Reports

```
TYPE={REPORT|heading|data}, IMAGE={url|file|(column)} [,BY=byfield]
[,SIZE=(w h)] , $
```

where:

REPORT

Embeds an image in the body of a report. The image appears in the background of the report. REPORT is the default value.

heading

Embeds an image in a heading or footing. Valid values are TABHEADING, TABFOOTING, FOOTING, HEADING, SUBHEAD, and SUBFOOT. Provide sufficient blank space in the heading or footing so that the image does not overlap the heading or footing text. You may also want to place heading or footing text to the right of the image using spot markers.

data

Defines a cell within a data column to place the image. Must be used with COLUMNS= attributes to identify the specific report column where the image should be anchored.

url

Is the URL of the image file.

file

Is the name of the image file. The image file or member must be allocated, and you can specify the DDNAME or, if the image is in a sequential file, the file name. If the image is in an APP, you can use the appname/filename syntax. When specifying a GIF file, you can omit the file extension.

column

Is an alphanumeric field in the data source that contains the name of an image file. Enclose the column in parentheses (). The field containing the file name or image must be a display field or BY field referenced in the request. Note that the value of the field is interpreted exactly as if it were typed as the URL of the image in the StyleSheet. If you omit the suffix, .GIF is supplied, by default. You can use the SET BASEURL command for supplying the base URL of the images. This way, the value of the field does not have to include the complete URL. This syntax is useful, for example, if you want to embed an image in a SUBHEAD, and you want a different image for each value of the BY field on which the SUBHEAD occurs.

byfield

Is the sort field that generates the subhead or subfoot.

SIZE

Is the size of the image. By default, an image is added at its original size.

w

Is the width of the image, expressed in the unit of measurement specified by the UNITS parameter. Enclose the *w* and *h* values in parentheses. Do not include a comma between them.

h

Is the height of the image, expressed in the unit of measurement specified by the UNITS parameter.

Adding a GIF Image to a Single Table Request

```
DYNAM ALLOC DD GIF1 DA USER1.GGLOGO.GIF SHR REU
DYNAM ALLOC DD GIF2 DA USER1.LOGO.GIF SHR REU
```

```
DEFINE FILE GGSales
SHOWCAT/A100=CATEGORY || '.GIF';
END
TABLE FILE GGSales
SUM DOLLARS/D12CM UNITS/D12C
BY LOWEST CATEGORY NOPRINT
BY SHOWCAT NOPRINT
BY PRODUCT
ACROSS REGION
WHERE CATEGORY NE 'Gifts'
```





```
ON CATEGORY SUBHEAD
" "
"Image in SUBHEAD for Category <CATEGORY "
" "
ON TABLE SUBHEAD
" "
" "
" Report Heading "
" "
ON CATEGORY SUBFOOT
"ON CATEGORY SUBFOOT"
```

```

ON TABLE SUBFOOT
"Report Footing"
" "
ON TABLE SET PAGE-NUM NOLEAD
ON TABLE NOTOTAL
ON TABLE SET ACROSSTITLE SIDE
ON TABLE HOLD FORMAT XLSX
ON TABLE SET STYLE *
TYPE=REPORT, GRID=OFF, FONT='ARIAL', SIZE=9, TITLETEXT='Food and
Coffee', $
TYPE=REPORT, COLUMN=PRODUCT, SQUEEZE=1, $
TYPE=TITLE, BACKCOLOR=RGB(90 90 90), COLOR=RGB(255 255 255),
STYLE=BOLD, $
TYPE=ACROSSTITLE, STYLE=BOLD, BACKCOLOR=RGB(90 90 90),
COLOR=RGB(255 255 255), $
TYPE=ACROSSVALUE, BACKCOLOR=RGB(218 225 232), STYLE=BOLD,
JUSTIFY=CENTER, $
TYPE=HEADING, STYLE=BOLD, COLOR=RGB(0 35 95), SIZE=12, JUSTIFY=Center, $
TYPE=FOOTING, BACKCOLOR=RGB(90 90 90), SIZE=12, COLOR=RGB(255 255 255),
STYLE=BOLD, JUSTIFY=CENTER, $
TYPE=SUBHEAD, SIZE=12, STYLE=BOLD, BACKCOLOR=RGB(218 225 232),
JUSTIFY=CENTER, $
TYPE=SUBHEAD, IMAGE=(SHOWCAT), SIZE=(.6 .6), $
TYPE=SUBFOOT, SIZE=10, STYLE=BOLD, JUSTIFY=CENTER, $
TYPE=TABHEADING, SIZE=12, STYLE=BOLD, JUSTIFY=CENTER, $
TYPE=TABHEADING, IMAGE=gglogo.gif, $
TYPE=TABFOOTING, SIZE=12, STYLE=BOLD, JUSTIFY=RIGHT, $
TYPE=TABFOOTING, IMAGE=logo.gif, SIZE=(1.67 .6), $
END

```

In the following request, since the referenced images are not part of the existing GGSALES table, the image files (.gif) are being built in the DEFINE and then referenced in the TABLE request. You can NOPRINT fields if you do not want them to display as columns, but the fields must be referenced in the table to include them in the internal matrix. This will allow the images to be placed in the headings, footings, or data cells. The specific location is defined using StyleSheet definitions for attaching the image based on the field value.

	A	B	C	D	E	F	G	H	I
1									
2	Report Heading								
3									
4									
5	Region	Midwest		Northeast		Southeast		West	
6	Product	Dollar Sales	Unit Sales	Dollar Sales	Unit Sales	Dollar Sales	Unit Sales	Dollar Sales	Unit Sales
7									
8	Image in SUBHEAD for Category Coffee								
9									
10	Capuccino	.	.	\$542,095	44,785	\$944,000	73,264	\$895,495	71,168
11	Espresso	\$1,294,947	101,154	\$850,107	68,127	\$853,572	68,030	\$907,617	71,675
12	Latte	\$2,883,566	231,623	\$2,771,815	222,866	\$2,617,836	209,654	\$2,670,405	213,920
13	ON CATEGORY SUBFOOT								
14									
15	Image in SUBHEAD for Category Food								
16									
17	Biscotti	\$1,091,727	86,105	\$1,802,005	145,242	\$1,505,717	119,594	\$863,868	70,436
18	Croissant	\$1,751,124	139,182	\$1,670,818	137,394	\$1,902,359	156,456	\$2,425,601	197,022
19	Scone	\$1,495,420	116,127	\$907,171	70,732	\$900,655	73,779	\$912,868	72,776
20	ON CATEGORY SUBFOOT								
21									Report Footing
22									
23									
24									

Inserting Images Into XLSX Workbook Headers and Footers

FOCUS supports the insertion of images into Excel headers and footers and the definition of key page settings within the Excel Worksheet Page Setup to support the placement of these images in relationship to the overall worksheet and Excel generated page breaks. This access to the Excel page functionality is designed to enhance overall usability of the worksheets for users who will be printing these reports. Page settings including orientation, page size, and page margins will directly affect the layout of each Excel page based on values defined within the FOCEXEC. Images can be included on headers and footers on every printed page, on the first page of the report only, or only on all subsequent pages. The FOCUS headings and footings continue to display within the worksheet. With this new feature, FOCUS can insert logos to be printed once at the top of a report and watermark images that need to be displayed on every printed page.

Insert Images Into Excel Headers and Footers

```
TYPE={PAGEHEADER|PAGEFOOTER},OBJECT=IMAGE,  
IMAGE=imagenam, JUSTIFY={LEFT|CENTER|RIGHT}  
[,DISPLAYON={FIRST|NOT-FIRST}]  
[,SIZE=(wh)],$
```

where:

PAGEHEADER

Places the image in the worksheet header.

PAGEFOOTER

Places the image in the worksheet footer.

imagenam

Is the name of a valid image file to be placed in the header or footer. The image must be available to FOCUS by being allocated to a DDNAME, and the image name in the StyleSheet must be the DDNAME. The image types supported are GIF and JPEG.

JUSTIFY={LEFT|CENTER|RIGHT}

Identifies the area in the header or footer to contain the image and the justification or placement within that defined area.

DISPLAYON

Defines whether the image should be placed on the first page only or on all pages except the first. Omit this attribute to place the image on all pages.

Valid values are:

FIRST places the image only on the first page.

NOT-FIRST places the image on every page except the first page.

SIZE=(wh)

Is the size of the image. By default, an image is added at its original size.

w is the width of the image, expressed in the unit of measurement specified by the UNITS parameter.

h is the height of the image, expressed in the unit of measurement specified by the UNITS parameter.

Inserting Images in Excel Headers and Footers and Defining Page Settings

The following request against the GGSALES data source places the image, ibi_logo.gif, on the left header area of the first page and the right header area of every other page of the resulting worksheet. It places the image webfocus1.gif in the center area of the footer on every page:

```
TABLE FILE GGSALES
SUM DOLLARS UNITS BUDDOLLARS BUDUNITS
BY REGION
BY ST
BY CATEGORY
BY PRODUCT
ON TABLE SET BYDISPLAY ON
ON TABLE HOLD FORMAT XLSX
ON TABLE SET STYLE *
FONT=ARIAL,SIZE=12,
XLSXPAGESETS=ON, TOPMARGIN=1, BOTTOMMARGIN=1, ORIENTATION=LANDSCAPE,
PAGESIZE=LETTER, $
TYPE=TITLE, COLOR=WHITE, BACKCOLOR=GREY, $
TYPE=PAGEHEADER, OBJECT=IMAGE, JUSTIFY=LEFT, IMAGE=IBI_LOGO.GIF,
DISPLAYON=FIRST, $
TYPE=PAGEHEADER, OBJECT=IMAGE, JUSTIFY=RIGHT, IMAGE=IBI_LOGO.GIF,
DISPLAYON=NOT-FIRST, $
TYPE=PAGEFOOTER, OBJECT=IMAGE, JUSTIFY=CENTER, IMAGE=webfocus1.gif, $
END
```

The first page of output has the image ibilogo.gif in the left area of the header and the image webfocus1.gif in the center area of the footer.

Information Builders		The Standard for Enterprise Business Intelligence		Region	State	Category	Product	Dollar Sales	Unit Sales	Budget Dollars	Budget Units
Mid west	IL	Coffee	Espresso	420439	32237	401477	32416				
Mid west	IL	Coffee	Latte	978340	77344	964787	79015				
Mid west	IL	Food	Biscotti	378412	29413	385369	30001				
Mid west	IL	Food	Croissant	549366	43300	528255	43271				
Mid west	IL	Food	Scone	595069	45355	567231	45091				
Mid west	IL	Gifts	Coffee Grinder	233292	19339	241711	19224				
Mid west	IL	Gifts	Coffee Pot	204828	15785	208255	16035				
Mid west	IL	Gifts	Mug	376754	30157	388612	30881				
Mid west	IL	Gifts	Thermos	187901	14651	181159	14137				
Mid west	MO	Coffee	Espresso	419143	32596	416875	32787				
Mid west	MO	Coffee	Latte	966981	77347	921336	77141				
Mid west	MO	Food	Biscotti	368077	29188	360403	28764				
Mid west	MO	Food	Croissant	613871	48941	592609	49327				
Mid west	MO	Food	Scone	481953	37602	478691	36573				
Mid west	MO	Gifts	Coffee Grinder	181570	14614	171501	14779				
Mid west	MO	Gifts	Coffee Pot	190153	14807	191451	14970				
Mid west	MO	Gifts	Mug	343852	27040	324488	26837				
Mid west	MO	Gifts	Thermos	195686	15592	189484	15903				
Mid west	TX	Coffee	Espresso	455365	36321	439880	36666				
Mid west	TX	Coffee	Latte	938245	76932	941677	77501				
Mid west	TX	Food	Biscotti	345238	27504	321857	27074				
Mid west	TX	Food	Croissant	587887	46941	587869	47050				
Mid west	TX	Food	Scone	418398	33170	398437	32112				
Mid west	TX	Gifts	Coffee Grinder	204292	16440	200241	16625				
Mid west	TX	Gifts	Coffee Pot	204897	16564	214301	16774				
Mid west	TX	Gifts	Mug	366337	29521	383050	29374				
Mid west	TX	Gifts	Thermos	194319	16344	193367	16779				
Northeast	CT	Coffee	Capuccino	158995	12386	141574	11098				
Northeast	CT	Coffee	Espresso	279373	22482	299854	23676				
Northeast	CT	Coffee	Latte	926052	74623	953855	74427				
Northeast	CT	Food	Biscotti	589355	46214	587501	46404				

powered by

The second page of output has the image `ibilogo.gif` in the right area of the header and the image `webfocus1.gif` in the center area of the footer.

Information Builders <small>The Standard for Enterprise Business Intelligence</small>							
Northeast	CT	Food	Croissant	551489	45847	580168	46335
Northeast	CT	Food	Scone	283874	22378	269221	21038
Northeast	CT	Gifts	Coffee Grinder	169908	13691	159620	13117
Northeast	CT	Gifts	Coffee Pot	208209	15523	197051	15190
Northeast	CT	Gifts	Mug	392967	31728	424333	32415
Northeast	CT	Gifts	Thermos	221827	17568	219025	17667
Northeast	MA	Coffee	Capuccino	174344	15358	192747	15672
Northeast	MA	Coffee	Espresso	248356	19698	254310	19888
Northeast	MA	Coffee	Latte	917737	74572	941438	73874
Northeast	MA	Food	Biscotti	570391	47064	616766	48246
Northeast	MA	Food	Croissant	497234	41029	519322	41351
Northeast	MA	Food	Scone	332486	25363	312004	23774
Northeast	MA	Gifts	Coffee Grinder	177940	14382	187686	15384
Northeast	MA	Gifts	Coffee Pot	184119	15349	184071	15171
Northeast	MA	Gifts	Mug	401944	32360	401617	31324
Northeast	MA	Gifts	Thermos	203435	16734	208436	16921
Northeast	NY	Coffee	Capuccino	208756	17041	227170	17662
Northeast	NY	Coffee	Espresso	322378	25947	318738	26212
Northeast	NY	Coffee	Latte	928026	73671	922776	73411
Northeast	NY	Food	Biscotti	642259	51964	644415	50502
Northeast	NY	Food	Croissant	622095	50518	640032	50178
Northeast	NY	Food	Scone	290811	22991	284478	23603
Northeast	NY	Gifts	Coffee Grinder	161352	12904	164336	12796
Northeast	NY	Gifts	Coffee Pot	198452	15313	192227	15043
Northeast	NY	Gifts	Mug	349300	27409	344364	26801
Northeast	NY	Gifts	Thermos	178836	14568	187786	15179
Southeast	FL	Coffee	Capuccino	317027	24143	285194	23092
Southeast	FL	Coffee	Espresso	256539	19730	236531	18690
Southeast	FL	Coffee	Latte	889887	71123	886465	72975
Southeast	FL	Food	Biscotti	511597	40606	516984	41242
Southeast	FL	Food	Croissant	602076	50175	644884	51437
Southeast	FL	Food	Scone	311836	24543	299547	24576

powered by 

Usage Notes for Inserting Images Into XLSX Worksheet Headers and Footers

- Excel headers and footers are not automatically sized based on contents of the areas. Define page margins within the page settings to account for the space required to display the images within each page of the report.
- The image sizing based on the specified height and width is not proportional. Sizing may cause image distortion.
- BLOB image fields are not supported in this release.

Displaying Watermarks on XLSX Output

Watermark images can be placed into the Excel headers to display on every printed page of the generated worksheet.

Excel places images on the page starting in the header from left to right and then the footer from left to right. Large images placed in the header may overlap images before them in the presentation order and will overlay the previous images. For page layouts with a logo in the left area and watermark centered on the page, watermark image background should be transparent so it does not overlay the logo image.

In Excel, images are placed first on the page. All other contents of the worksheet are then placed on top of the images. Text in cells and styling such as background color and drawing objects are placed on top of the images. Excel supports transparency in drawing objects and images, but not in cell background color. BACKCOLOR will cover over images placed on the page.

Placing a Watermark in an XLSX Header

The following request against the GGSALES data source uses the image `internaluseonly.gif` as a watermark to display in the background of every page of the worksheet. Although the image is placed in the center area of the header, it is large enough to span the entire worksheet page. It has a transparent background, so it does not cover the logo images placed at the left in the header and the center in the footer:

```
TABLE FILE GGSALES
SUM DOLLARS UNITS BUDDOLLARS BUDUNITS
BY REGION
BY ST
BY CATEGORY
BY PRODUCT
ON TABLE SET BYDISPLAY ON
ON TABLE HOLD FORMAT XLSX
ON TABLE SET STYLE *
XLSXPAGESETS=ON,
TOPMARGIN=1,BOTTOMMARGIN=1,LEFTMARGIN=1, RIGHTMARGIN=1,
ORIENTATION=LANDSCAPE,PAGESIZE=LETTER,$
TYPE=PAGEHEADER, OBJECT=IMAGE, JUSTIFY=LEFT, IMAGE=IBI_LOGO.GIF,
DISPLAYON=FIRST, $
TYPE=PAGEHEADER, OBJECT=IMAGE, JUSTIFY=CENTER,
IMAGE=INTERNALUSEONLY.GIF, $
```

```
TYPE=PAGEFOOTER, OBJECT=IMAGE, JUSTIFY=RIGHT, IMAGE=WEBFOCUS1.GIF, $
END
```

The first page of the generated worksheet shows the watermark image beneath the data. This image is displayed on every page of the worksheet.

Information Builders		The Standard for Enterprise Business Intelligence					
Region	State	Category	Product	Dollar Sales	Unit Sales	Budget Dollars	Budget Units
Midwest	IL	Coffee	Espresso	420439	32237	401477	32416
Midwest	IL	Coffee	Latte	978340	77344	964767	79015
Midwest	IL	Food	Biscotti	378412	29413	386369	30001
Midwest	IL	Food	Croissant	549368	43300	528255	43271
Midwest	IL	Food	Soone	595069	45355	587231	45091
Midwest	IL	Gifts	Coffee Grinder	233292	19339	241711	19224
Midwest	IL	Gifts	Coffee Pot	204828	15785	208255	16035
Midwest	IL	Gifts	Mug	378754	30157	389812	30881
Midwest	IL	Gifts	Thermos	187901	14851	181159	14137
Midwest	MO	Coffee	Espresso	419143	32596	418875	32787
Midwest	MO	Coffee	Latte	968931	77347	921336	77141
Midwest	MO	Food	Biscotti	368077	29188	360403	28764
Midwest	MO	Food	Croissant	613871	48941	592609	49327
Midwest	MO	Food	Soone	481956	37802	478691	36573
Midwest	MO	Gifts	Coffee Grinder	131570	14614	171501	14779
Midwest	MO	Gifts	Coffee Pot	130153	14807	191451	14970
Midwest	MO	Gifts	Mug	343852	27040	324488	26837
Midwest	MO	Gifts	Thermos	195688	15562	189484	15903
Midwest	TX	Coffee	Espresso	455365	36321	439880	36666
Midwest	TX	Coffee	Latte	938245	76932	941677	77501
Midwest	TX	Food	Biscotti	345238	27504	321857	27074
Midwest	TX	Food	Croissant	587887	46941	587889	47060
Midwest	TX	Food	Soone	418398	33170	398437	32112
Midwest	TX	Gifts	Coffee Grinder	204292	16440	200241	16625
Midwest	TX	Gifts	Coffee Pot	204897	16564	214301	16774
Midwest	TX	Gifts	Mug	388337	29521	383050	29374
Midwest	TX	Gifts	Thermos	194319	16344	193367	16779
Northeast	CT	Coffee	Capuccino	158995	12388	141574	11088
Northeast	CT	Coffee	Espresso	279373	22482	298854	23876
Northeast	CT	Coffee	Latte	928052	74823	953855	74427
Northeast	CT	Food	Biscotti	589355	46214	587501	46404
Northeast	CT	Food	Croissant	551489	45847	580168	46335
Northeast	CT	Food	Soone	283874	22378	265221	21038
Northeast	CT	Gifts	Coffee Grinder	169908	13691	159620	13117
Northeast	CT	Gifts	Coffee Pot	203209	15523	197051	15190
Northeast	CT	Gifts	Mug	392967	31728	424333	32415

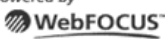
powered by

Creating Excel 2007/2010 Worksheets Using Templates

EXL07 report output can be generated based on Excel 2007/2010 templates. This feature allows for the integration of WebFOCUS reports into workbooks containing multiple worksheets, as well as native Excel 2007/2010 formulas, tables, graphs, images, and cell, page, and worksheet formatting. Any native Excel 2007/2010 template can be used to generate a new workbook containing a WebFOCUS report.

The following Excel file types can be used as template files to generate EXL07 workbooks.

Template File Type	Output Workbook Generated
Template (.xltx)	Workbook (.xlsx)
Macro-Enabled Template (.xlsm)	Macro-Enabled Workbook (.xlsm)
Workbook (.xlsx)	Workbook (.xlsx)
Macro-Enabled Workbook (.xlsm)	Macro-Enabled Workbook (.xlsm)

WebFOCUS EXL07 TEMPLATE format provides support for basic Excel templates (.xltx) files. These templates do not support macros or other content that Microsoft considers active.

A WebFOCUS EXL07 template procedure generates a native Excel 2007/2010 workbook with the standard .xlsx extension, based on the defined template file. The WebFOCUS request will replace an existing worksheet within the template workbook, and any formulas or references defined in other worksheets to cells within the replaced worksheet will automatically update when the workbook is opened.

The designated worksheet is replaced with each execution of the WebFOCUS procedure. Any content added to the replaced worksheet within the template will not be retained. Content contained on any other worksheets will be retained and updated.

Named ranges can be defined within the procedure using the INRANGES attribute to designate cell groupings that can be referenced by other worksheets.

An Excel 2007/2010 template can be generated by saving any workbook with the .xltx extension. The template file should be stored within your application path (EDAPATH or APP PATH), rather than the default Excel template directory so that it can be accessed by the WebFOCUS Reporting Server when the procedure is executed.

The EXL07 TEMPLATE feature is supported in Version 7 Release 7.02 for basic EXL07 format reports. The following features are not supported with EXL07 TEMPLATE in this release: PIVOT, BYTOC, FORMULA, EXL97, EXCEL, and compound Excel reports.

In most cases, existing Excel 2000/2003 templates created as .mht files can easily be converted to Excel 2007/2010 templates by opening the .mht file in Excel 2007/2010 and resaving the file as an Excel template (.xltx) file. Active content, including macros, will be removed from the file, but native Excel formulas and functionality should be retained.

Create an EXL07 Report Using Any Supported Template File Type

To support the expanded template files types, the template file name attribute has been enhanced to allow for the inclusion of the file extension. If no extension is specified within the template name, the file extension will default to .xltx.

```
ON TABLE PCHOLD FORMAT EXL07 TEMPLATE template_name SHEETNUMBER n
```

where:

template_name

Is the name of the Excel template file (workbook), including the file name and extension, residing on the WebFOCUSWebFOCUS Reporting Server application directory search path. For example, ipolicy.xltx, printsheets.xlsm, or dashboard.xlsm. If the extension is not provided, it defaults to .xltx.

n

Is the number of the Excel worksheet being replaced in the template file (workbook).

Usage Notes for EXL07 Templates

The workbook template used by the WebFOCUS procedure must contain valid worksheets.

- The sheet that is updated must exist in the workbook, as WebFOCUS is replacing the worksheet, rather than inserting a worksheet. If the sheet designated does not exist, the procedure will return an error.
- In any template file, at least one of the sheets in the workbook must contain a cell with a valid value (blank or any other value). To replace a worksheet in a template that contains only empty worksheets, replace one of the cells in any of the sheets with a space, and save. This will instantiate the worksheets so they are accessible to WebFOCUS for updating.

Creating Excel Table of Contents Reports

Excel Table of Contents (BYTOC) enables you to generate a separate worksheet within an instance of the report for each value of the first BY field in the FOCUS report.

Use the Excel Table of Contents Feature

```
ON TABLE HOLD FORMAT XLSX BYTOC
```

Since a BYTOC report generates separate worksheets according to the value of the first BY field in the report, the report must contain at least one BY field. The primary BY field may be a NOPRINT field.

Creating a Simple BYTOC Report

The following request against the GGSales data source creates separate tabs based on the REGION sort field.

```
TABLE FILE GGSales
SUM UNITS/D12C DOLLARS/D12CM
BY REGION NOPRINT
BY CATEGORY
BY PRODUCT
HEADING
"<REGION Region Sales"
ON TABLE HOLD FORMAT XLSX BYTOC
ON TABLE SET BYDISPLAY ON
ON TABLE SET STYLE *
TYPE=REPORT, FONT=ARIAL, SIZE=9,$
TYPE=HEADING, SIZE=12,$
TYPE=TITLE, BACKCOLOR=GREY, COLOR=WHITE,$
ENDSTYLE
END
```

The output is:

	A	B	C	D
1	Midwest Region Sales			
2	Category	Product	Unit Sales	Dollar Sales
3	Coffee	Espresso	101,154	\$1,294,947
4	Coffee	Latte	231,623	\$2,883,566
5	Food	Biscotti	86,105	\$1,091,727
6	Food	Croissant	139,182	\$1,751,124
7	Food	Scone	116,127	\$1,495,420
8	Gifts	Coffee Grinder	50,393	\$619,154
9	Gifts	Coffee Pot	47,156	\$599,878
10	Gifts	Mug	86,718	\$1,086,943
11	Gifts	Thermos	46,587	\$577,906
12				

How to Name Worksheets

- The worksheet tab names are the BY field values that correspond to the data on the current worksheet. If the user specifies the TITLETEXT keyword in the StyleSheet, it will be ignored.
- Excel limits the length of worksheet titles to 31 characters. The following special characters cannot be used: ':', '?', '*', and '/'.
- If you want to use date fields as the bursting BY field, you can include the - character instead of the / character. The - character is valid in an Excel tab title. However, if you do use the / character, FOCUS will substitute it with the - character.

Naming XLSX Worksheets With Case Sensitive Data

Excel requires each sheet name to be unique. Excel is case insensitive meaning it evaluates two values as being the same when the values contain the same characters but have different casing. For example, Excel evaluates the values WEST and West to be the same value. FOCUS XLSX format identifies duplicate names and adds a unique number to the name to allow Excel to maintain both sheets.

By default, FOCUS sort processing is case-sensitive, so the same field value with different casing is considered to be two different values when used as a sort (BY) field. In an Excel

BYTOC report, FOCUS will generate sheets with sheet names for each value of the primary sort (BY) key based on case sensitivity. To account for this, XLSX has been enhanced to add counters where duplicate tab names are found in the data to ensure the names are unique.

For example, if the report had EAST and East as the values for the Region, each worksheet would be displayed as EAST(1) and East(2), as shown in the following image.

	A	B	C	D
1	East Region Sales			
2	Category	Product	Unit Sales	Dollar Sales
3	Coffee	Capuccino	73,264	\$944,000
4	Coffee	Espresso	68,030	\$853,572
5	Coffee	Latte	209,654	\$2,617,836
6	Food	Biscotti	119,594	\$1,505,717
7	Food	Croissant	156,456	\$1,902,359
8	Food	Scone	73,779	\$900,655
9	Gifts	Coffee Grinder	47,083	\$605,777
10	Gifts	Coffee Pot	49,922	\$645,303
11	Gifts	Mug	88,474	\$1,102,703
12	Gifts	Thermos	48,976	\$632,457
13				
14				

EAST(1) East(2) WEST(1) West(2)

Overcoming the Excel 2007 and 2010 Row Limit Using Overflow Worksheets

The maximum number of rows supported by Excel 2007 and 2010 on a worksheet is 1,048,576 (1MB). When you create an XLSX output file from a FOCUS report, the number of rows generated can be greater than this maximum.

To avoid creating an incomplete output file, you can have extra rows flow onto a new worksheet, called an *overflow worksheet*. The name of each overflow worksheet will be the name of the original worksheet appended with an increment number.

In addition, when the overflow worksheet feature is enabled, you can set a target value for the maximum number of rows to be included on a worksheet. By default, the row limit will be set to the default value for the LINES parameter (57).

i Note: By default, when generating XLSX output, the FOCUS page heading and page footing commands generate only worksheet headings and worksheet footings.

Enable Overflow Worksheets

Add the ROWOVERFLOW attribute to your FOCUS StyleSheet

```
TYPE=REPORT, ROWOVERFLOW={ON|OFF|PBON}, [ROWLIMIT={n|MAX}]...
```

where:

ON

Enables overflow worksheets.

OFF

Disables overflow worksheets. OFF is the default value.

PBON

Inserts FOCUS page breaks that display the page heading, footing, and column titles at the appropriate places within the worksheet rows. This option does not cause a new worksheet to start when a FOCUS page break occurs.

ROWLIMIT=n

Sets a target value for the number of rows to be included on a worksheet to **n** rows. The default value is the LINES value (by default, 57).

ROWLIMIT=MAX

Sets a target value for the number of rows to be included on a Worksheet to 1,048,000 rows for XLSX output.

This attribute works with all Excel output formats. For all other output types, the ROWOVERFLOW StyleSheet attribute is ignored, and data flow is not affected.

Usage Notes for XLSX Overflow Worksheets

- The report heading is placed once at the start of the first sheet. The report footing is placed once at the bottom of the last overflow sheet.
- Unless the PBON setting is used, worksheet headings and column titles are repeated at the top of the original sheet and each subsequent overflow sheet. Worksheet footings are placed at the bottom of the original sheet and each subsequent overflow sheet. The data values are displayed on the top data row of each overflow sheet as they would be on a standard new page.
- Report total lines are displayed at the bottom of the last overflow sheet directly above the final page and table footings.
- Subheadings, subfootings, and subtotal lines display within the data flow as normal. No special consideration is made to retain groupings within a given sheet.
- If ROWOVERFLOW=PBON, the page headings and footings and column titles display within the worksheet when a FOCUS command causes a page break.
- For XLSX output, if the ROWOVERFLOW attribute is specified in the StyleSheet and ROWLIMIT is greater than 1MB, the following message is presented and no output file is generated:

```
(FOC3338) The row limit for EXCEL XLSX worksheets is 1048576.
```

- Output types that contain formula references, such as XLSX FORMULA, are not supported, as formula references are not automatically updated to reflect placement on new overflow worksheets.
- The overflow worksheet feature applies to rows only, not columns. A new worksheet will not automatically be created if a report generates more than the Excel 2007/2010 limit or 16,384 columns.
- ROWOVERFLOW is supported for BYTOC reports for XLSX.
- As named ranges in Excel cannot run across multiple worksheets, the IN-RANGES phrase that defines named ranges in the resulting workbook is not supported with the ROWOVERFLOW feature. When they exist together in the same request, ROWOVERFLOW takes precedence, and the IN-RANGES phrase is ignored.

Creating Overflow Worksheets

The following request creates XLSX report output with overflow worksheets. The ROWOVERFLOW=ON attribute in the StyleSheet activates the overflow feature. Without this attribute, one worksheet would have been generated instead of three.

```
TABLE FILE GGSales
- * ****Report Heading****
ON TABLE SUBHEAD
"SALES BY REGION, CATEGORY, AND PRODUCT"
" "

- * ****Worksheet Heading****
HEADING
"SALES REPORT WORKSHEET <TABPAGENO"
" "

- * ****Worksheet Footing****
FOOTING
" "

"END OF WORKSHEET <TABPAGENO"
PRINT DOLLARS UNITS BUDDOLLARS BUDUNITS
BY REGION
BY CATEGORY
BY PRODUCT
BY DATE

- * ****Subfoot****
ON REGION SUBFOOT
" "

" End of Region <REGION"
" "

- * ****Subhead****
ON REGION SUBHEAD
" "

"Category <CATEGORY for Region <REGION"
" "

- * ****Report Footing****
ON TABLE SUBFOOT
" "

"END OF REPORT"
ON TABLE HOLD FORMAT XLSX
ON TABLE SET STYLE *
TYPE=REPORT, TITLETEXT=EXLOVER, ROWOVERFLOW=ON, ROWLIMIT=2000,$
```

```
ENDSTYLE
END
```

The report heading displays on the first worksheet only, the page heading and column titles display on each worksheet, and the subhead and subfoot display whenever the associated sort field changes value. The following image shows the top of the first worksheet, displaying the report heading, page heading, column titles, and first subhead.

SALES BY REGION, CATEGORY, AND PRODUCT								
SALES REPORT WORKSHEET 1								
Region	Category	Product	Date	Dollar Sales	Unit Sales	Budget Dollars	Budget Units	
Category Coffee for Region Midwest								
Midwest	Coffee	Espresso	1996/01/01	19752	1646	24141	1857	
				13416	1118	16068	1236	
				13170	878	10000	1000	
				10164	924	12552	1046	
				6048	432	6565	505	
				4693	361	8310	554	
			1996/02/01	16968	1212	13622	973	
				13420	1220	20415	1361	
				13095	873	6910	691	
				8340	834	8460	705	
				6454	461	8540	610	
				4355	335	5400	360	
			1996/03/01	18466	1319	15120	1512	
				18135	1395	17069	1313	
				12690	846	7060	706	
				11450	1145	14490	1035	
				10802	982	9555	735	
				10023	771	9180	765	

Note that the TITLETEXT attribute in the StyleSheet specified the name EXLOVER, so the three worksheets were generated with the names EXLOVER1, EXLOVER2, and EXLOVER3. If there had been no TITLETEXT attribute, the sheets would have been named SHEET1, SHEET2, and SHEET3.

The worksheet footing displays at the bottom of each worksheet and the report footing displays at the bottom of the last worksheet. The following image shows the bottom of the last worksheet, displaying the last subfoot, the page footing, and the report footing.

SALES REPORT WORKSHEET 3										
A	B	C	D	E	F	G	H	I	J	
363				9194	657	7722	772			
364				8981	816	7983	665			
365			1997/08/01	14276	1020	17087	1139			
366				8679	868	7366	737			
367				2179	168	1911	127			
368			1997/09/01	4380	365	5869	451			
369				2152	215	3732	287			
370				1459	112	0	0			
371			1997/10/01	9798	754	8070	673			
372				6402	640	9880	659			
373				6302	450	6570	597			
374			1997/11/01	8448	845	7855	714			
375				6154	440	4966	451			
376				4552	414	4844	484			
377			1997/12/01	15092	1161	16549	1182			
378				11197	746	13464	898			
379				10346	690	10536	810			
380										
381	End of Region West									
382										
383										
384	END OF WORKSHEET 3									
385										
386	END OF REPORT									

Creating Overflow Worksheets With FOCUS Page Breaks

The following request creates XLSX report output with overflow worksheets. The ROWOVERFLOW=PBON attribute in the StyleSheet activates the overflow feature, and the ROWLIMIT=250 sets the maximum number of rows in each worksheet to approximately 250. Without this attribute, one worksheet would have been generated. The PRODUCT sort phrase specifies a page break.

```
TABLE FILE GGSALES
  -* ****Report Heading****
  ON TABLE SUBHEAD
  "SALES BY REGION, CATEGORY, AND PRODUCT"
  " "
  PRINT DOLLARS UNITS BUDDOLLARS BUDUNITS
  BY REGION
  BY HIGHEST CATEGORY
  BY PRODUCT PAGE-BREAK
  BY DATE
  WHERE DATE GE '19971001'
  -* ****Page Heading****
  HEADING
  " Product: <PRODUCT in Category: <CATEGORY for Region: <REGION"
```

```
-* ****Page Footing****  
FOOTING  
" "  
-* ****Report Footing****  
ON TABLE SUBFOOT  
" "  
"END OF REPORT"  
ON TABLE SET BYDISPLAY ON  
ON TABLE HOLD FORMAT XLSX  
ON TABLE SET STYLE *  
INCLUDE=endflt,TITLETEXT=EXLOVER, ROWOVERFLOW=PBON, ROWLIMIT=250,  
$  
ENDSTYLE  
END
```

The report heading displays on the first worksheet only, the page heading, footing, and column titles display on each worksheet and at each FOCUS page break (each time the product changes), and the subhead and subfoot display whenever the associated sort field changes value. The following image shows the top of the first worksheet.

SALES BY REGION, CATEGORY, AND PRODUCT

Product: Coffee Grinder in Category: Gifts for Region: Midwest

Region	Category	Product	Date	Dollar Sales	Unit Sales	Budget Dollars	Budget Units
Midwest	Gifts	Coffee Grinder	1997/10/01	14494	95.6	1175.4	1059
Midwest	Gifts	Coffee Grinder	1997/10/01	3453	49.6	601.9	502
Midwest	Gifts	Coffee Grinder	1997/10/01	1750	13.9	217.9	149
Midwest	Gifts	Coffee Grinder	1997/11/01	12333	114.0	1009.7	1191
Midwest	Gifts	Coffee Grinder	1997/11/01	12190	110.8	1487.1	1041
Midwest	Gifts	Coffee Grinder	1997/11/01	9352	89.6	1016.1	947
Midwest	Gifts	Coffee Grinder	1997/12/01	47468	360.9	4803.6	3737
Midwest	Gifts	Coffee Grinder	1997/12/01	7356	49.0	650.1	630
Midwest	Gifts	Coffee Grinder	1997/12/01	4073	37.0	513.9	513
Midwest	Gifts	Coffee Grinder	1997/12/01	1967	17.9	354.0	329

Product: Coffee Pot in Category: Gifts for Region: Midwest

Region	Category	Product	Date	Dollar Sales	Unit Sales	Budget Dollars	Budget Units
Midwest	Gifts	Coffee Pot	1997/10/01	12333	107.0	1533.9	1032
Midwest	Gifts	Coffee Pot	1997/10/01	11609	116.1	1542.9	1216
Midwest	Gifts	Coffee Pot	1997/10/01	1378	11.9	112.4	86
Midwest	Gifts	Coffee Pot	1997/11/01	8348	69.6	1099.1	949
Midwest	Gifts	Coffee Pot	1997/11/01	3181	31.8	910.1	630
Midwest	Gifts	Coffee Pot	1997/11/01	3722	34.8	335.4	199
Midwest	Gifts	Coffee Pot	1997/12/01	10393	70.6	830.6	654
Midwest	Gifts	Coffee Pot	1997/12/01	9237	61.7	965.9	644
Midwest	Gifts	Coffee Pot	1997/12/01	3800	44.6	423.1	392

Product: Mug in Category: Gifts for Region: Midwest

Region	Category	Product	Date	Dollar Sales	Unit Sales	Budget Dollars	Budget Units
Midwest	Gifts	Mug	1997/10/01	14492	111.9	1555.2	1044
Midwest	Gifts	Mug	1997/10/01	14339	95.6	1264.2	947
Midwest	Gifts	Mug	1997/10/01	11270	112.7	1178.1	1178
Midwest	Gifts	Mug	1997/10/01	10746	76.9	1102.9	739
Midwest	Gifts	Mug	1997/10/01	7319	73.2	954.1	702
Midwest	Gifts	Mug	1997/10/01	4959	33.3	553.9	399
Midwest	Gifts	Mug	1997/11/01	11450	88.0	973.9	749
Midwest	Gifts	Mug	1997/11/01	9399	72.3	777.9	707
Midwest	Gifts	Mug	1997/11/01	3891	33.9	1107.9	739
Midwest	Gifts	Mug	1997/11/01	4917	49.2	593.9	496
Midwest	Gifts	Mug	1997/11/01	1960	15.1	333.1	339
Midwest	Gifts	Mug	1997/11/01	1956	19.0	391.1	360
Midwest	Gifts	Mug	1997/12/01	19399	109.0	1999.2	1039
Midwest	Gifts	Mug	1997/12/01	14913	114.7	1463.0	1216
Midwest	Gifts	Mug	1997/12/01	14659	112.7	1790.9	1194
Midwest	Gifts	Mug	1997/12/01	14337	110.0	1999.9	1133

Generating XLSX Compound Reports Using the OPEN, CLOSE, and NOBREAK Keywords

The keywords OPEN, CLOSE, and NOBREAK are used to control Excel compound reports. They can be specified with the HOLD command or with a separate SET COMPOUND command.

- OPEN is used on the first report of a sequence of component reports to specify that a compound report should be started.
- CLOSE is used to designate the last report in a compound report.

- NOBREAK specifies that the next report be placed on the same worksheet as the current report. If it is not present, the default behavior is to place the next report on a separate worksheet.
- When used with the HOLD syntax, the compound report keywords OPEN, CLOSE, and NOBREAK must appear immediately after FORMAT XLSX. For example, you can specify:
 - `ON TABLE PCHOLD FORMAT XLSX OPEN`
 - `ON TABLE HOLD AS MYHOLD FORMAT XLSX OPEN NOBREAK`
- As with PDF compound reports, compound report keywords can be alternatively specified using SET COMPOUND:
 - `SET COMPOUND = OPEN`
 - `SET COMPOUND = 'OPEN NOBREAK'`
 - `SET COMPOUND = NOBREAK`
 - `SET COMPOUND = CLOSE`

Guidelines for Producing Excel Compound Reports Using XLSX

- **Naming of Worksheets.** The default worksheet tab names will be Sheet1, Sheet2, and so on. You have the option to specify a different worksheet tab name by using the TITLETEXT keyword in the StyleSheet. For example:

```
TYPE=REPORT, TITLETEXT='Summary Report', $
```

Excel limits the length of worksheet titles to 31 characters. The following special characters cannot be used: ':', '?', '*', and '/'.

- **File Names and Formats.** The output file name (AS name, or HOLD by default) is obtained from the first report of the compound report (the report with the OPEN keyword). Output file names on subsequent reports are ignored.

The HOLD FORMAT syntax used in the first component report in a compound report applies to all subsequent reports in the compound report, regardless of their format.

- **NOBREAK Behavior.** When NOBREAK is specified, the following report appears on the row immediately after the last row of the report with the NOBREAK. If additional spacing is required between the reports, a FOOTING or an ON TABLE SUBFOOT can be placed on the report with the NOBREAK, or a HEADING or an ON TABLE SUBHEAD can be placed on the following report. This allows the most flexibility, since if blank rows were added by default, there would be no way to remove them.

Creating a Simple Compound Report Using XLSX

```
SET PAGE-NUM=OFF
TABLE FILE GGSALES
HEADING
"Report 1: Coffee - Budget"
" "
SUM BUDDOLLARS BUDUNITS COLUMN-TOTAL AS 'Total'
BY REGION
ON TABLE SET STYLE *
TYPE=REPORT, TITLETEXT=Coffee Budget,$
TYPE=HEADING, SIZE=14,$
ENDSTYLE
ON TABLE HOLD AS EX1 FORMAT XLSX OPEN
END
```

```
TABLE FILE GGSALES
HEADING
"Report 2: Coffee - Actual "
SUM DOLLARS UNITS COLUMN-TOTAL AS 'Total'
BY REGION
ON TABLE HOLD FORMAT XLSX
ON TABLE SET STYLE *
TYPE=REPORT, TITLETEXT=Coffee Actual,$
TYPE=HEADING, SIZE=14,$
ENDSTYLE
END
```

```
TABLE FILE GGSALES
HEADING
"Report 3: Food - Budget"
SUM BUDDOLLARS BUDUNITS COLUMN-TOTAL AS 'Total'
BY REGION
ON TABLE SET STYLE *
```

```

TYPE=REPORT, TITLETEXT=Food Budget,$
TYPE=HEADING, SIZE=14,$
ENDSTYLE
ON TABLE HOLD FORMAT XLSX CLOSE
END

```

The output is:

Report 1: Coffee - Budget			Report 2: Coffee - Actual			Report 3: Food - Budget					
2	Region	Budget Dollars	Budget Units	2	Region	Dollar Sales	Unit Sales	2	Region	Budget Dollars	Budget Units
3	Midwest	11194373	907107	3	Midwest	11400665	905045	3	Midwest	11194373	907107
4	Northeast	11576921	914359	4	Northeast	11392300	916675	4	Northeast	11576921	914359
5	Southeast	11807971	942247	5	Southeast	11710379	935232	5	Southeast	11807971	942247
6	West	11641513	930781	6	West	11652946	932039	6	West	11641513	930781
7	Total	46220778	3694494	7	Total	46166290	3688991	7	Total	46220778	3694494

Creating a Compound Report Using NOBREAK

In this example, the first two reports are on the first worksheet, and the last two reports are on the second worksheet, since NOBREAK appears on both the first and third reports.

```

TABLE FILE GGSales
HEADING
"Report 1: Coffee - Budget"
SUM BUDDOLLARS BUDUNITS COLUMN-TOTAL AS 'Total'
BY REGION
IF CATEGORY EQ Coffee
ON TABLE HOLD FORMAT XLSX OPEN NOBREAK
ON TABLE SET STYLE *
TYPE=REPORT, TITLETEXT=Coffee, FONT=ARIAL, SIZE=10, STYLE=NORMAL,$
TYPE=TITLE, STYLE=BOLD,$
TYPE=HEADING, SIZE=12, STYLE=BOLD, COLOR=BLUE,$
TYPE=GRANDTOTAL, STYLE=BOLD,$
END

```

```

TABLE FILE GGSales
HEADING
" "
"Report 2: Coffee - Actual "

```

```

SUM DOLLARS UNITS COLUMN-TOTAL AS 'Total'
BY REGION
IF CATEGORY EQ Coffee
ON TABLE HOLD FORMAT XLSX
ON TABLE SET STYLE *
TYPE=REPORT, FONT=ARIAL, SIZE=10, STYLE=NORMAL,$
TYPE=GRANDTOTAL, STYLE=BOLD,$
TYPE=HEADING, SIZE=12, STYLE=BOLD, COLOR=BLUE,$
END

```

```

TABLE FILE GGSALES
HEADING
"Report 3: Food - Budget"
SUM BUDDOLLARS BUDUNITS COLUMN-TOTAL AS 'Total'
BY REGION
IF CATEGORY EQ Food
ON TABLE HOLD FORMAT XLSX NOBREAK
ON TABLE SET STYLE *
TYPE=REPORT, TITLETEXT=Food, FONT=ARIAL, SIZE=10, STYLE=NORMAL,$
TYPE=HEADING, STYLE=BOLD, SIZE=12, COLOR=BLUE,$
TYPE=TITLE, STYLE=BOLD,$
TYPE=GRANDTOTAL, STYLE=BOLD,$
END

```

```

TABLE FILE GGSALES
HEADING
" "
"Report 4: Food - Actual"
SUM DOLLARS UNITS COLUMN-TOTAL AS 'Total'
BY REGION
IF CATEGORY EQ Food
ON TABLE HOLD FORMAT XLSX CLOSE
ON TABLE SET STYLE *
TYPE=REPORT, FONT=ARIAL, SIZE=10, $
TYPE=TITLE, STYLE=BOLD,$
TYPE=HEADING, SIZE=12, STYLE=BOLD, COLOR=BLUE,$
TYPE=GRANDTOTAL, STYLE=BOLD,$
END

```

Report output is displayed in two separate tabs.

Region	Budget Dollars	Budget Units
Midwest	4086032	335526
Northeast	4252462	335920
Southeast	4431429	355693
West	4523963	358784
Total	17293886	1385923

Region	Dollar Sales	Unit Sales
Midwest	4178513	332777
Northeast	4164017	335778
Southeast	4415408	350948
West	4473517	356763
Total	17231455	1376266

Region	Budget Dollars	Budget Units
Midwest	4220721	339263
Northeast	4453907	351431
Southeast	4409288	351509
West	4183244	335361
Total	17267160	1377564

Region	Dollar Sales	Unit Sales
Midwest	4338271	341414
Northeast	4379994	353368
Southeast	4308731	349829
West	4202337	340234
Total	17229333	1384845

Format XLSX Limitations

Format XLSX does not support the following features currently supported for EXL2K:

- Cell Locking.
- Pivot Tables.
- Templates.

Assigning EXL2K Format to Your Report Output

The command `ON TABLE HOLD FORMAT EXL2K` generates a fully styled Excel report in your browser, with conditional styling capability.

The EXL2K (Excel 2000/2003) format is a full StyleSheet driver that renders all report elements (for example, headings and subtotals) as well as StyleSheet syntax (such as, conditional styling).

EXL2K format accurately displays formatted dates and numeric values and controls column width and wrapping in Excel 2000/2003. See [Using Excel Display Formats: XLSX, EXL2K, EXL97](#), [Using Excel Display Formats: XLSX, EXL2K, EXL97](#) and [Using Excel Display Formats: XLSX, EXL2K, EXL97](#).

In addition, the format variation EXL2K FORMULA enables you to convert summed information (such as column totals, row totals, subtotals) and calculated values to interactive formulas in an Excel 2000/2003 worksheet. See [Using Excel Display Formats: XLSX, EXL2K, EXL97](#). Another format variation, EXL2K PIVOT, enables you to analyze different views of your data. See [Using Excel Display Formats: XLSX, EXL2K, EXL97](#).

EXL2K is supported only in Excel 2000 or 2003. It does not work with any previous releases of Excel. You can invoke format EXL2K reports using any browser supported by FOCUS.

By default, when you choose EXL2K as your display format, the report opens in an Excel 2000/2003 worksheet, identified in a tab at the bottom of the worksheet as **Sheet1**, **Sheet2**, and so on. You can change the name of a Sheet tab to make it more descriptive of your report's content.

Creating an EXL2K Report

The following example illustrates how to create a report in EXL2K (Excel 2000/2003) format with a styled heading, conditional styling on SALES, and drill-downs on COUNTRY:

```
TABLE FILE CAR
HEADING
"SALES BY COUNTRY"
SUM SALES BY COUNTRY BY CAR BY MODEL
WHERE (COUNTRY EQ 'ENGLAND') OR (COUNTRY EQ 'ITALY') OR (COUNTRY EQ
'FRANCE');
ON TABLE HOLD FORMAT EXL2K
ON TABLE SET STYLE *
TYPE=REPORT, FONT=ARIAL, TITLETEXT=SALES REPORT, $
TYPE=DATA, COLUMN=COUNTRY, FOCEXEC=DRILLFEX (PARAM1=COUNTRY
PARAM2=CAR), $
TYPE=DATA, COLUMN=SALES, COLOR=RED, BACKCOLOR=YELLOW, WHEN=SALES GT
10000, $
TYPE=DATA, COLUMN=MODEL, BACKCOLOR=YELLOW, WHEN=SALES GT 10000, $
TYPE=HEADING, FONT=ARIAL BLACK, COLOR=RED, BACKCOLOR=SILVER, SIZE=16, $
TYPE=TITLE, FONT=ARIAL, SIZE=12, $
ENDSTYLE
END
```

The output is:

	A	B	C	D	E	F
1	SALES BY COUNTRY					
2	COUNTRY	CAR	MODEL	SALES		
3	ENGLAND	JAGUAR	V12XKE AUTO	0		
4			XJ12L AUTO	12000		
5		JENSEN	INTERCEPTOR III	0		
6		TRIUMPH	TR7	0		
7	FRANCE	PEUGEOT	504 4 DOOR	0		
8	ITALY	ALFA ROMEO	2000 4 DOOR BERLINA	4800		
9			2000 GT VELOCE	12400		
10			2000 SPIDER VELOCE	13000		
11		MASERATI	DORA 2 DOOR	0		
12						
13						
14						
15						

Notice that the tab name has been changed from the Excel default, Sheet1, to a more descriptive name, which is specified in the TITLETEXT attribute of the StyleSheet. For details on the TITLETEXT attribute see [Customizing Tabular Reports](#).

Create a Styled EXL2K File

```
[ON TABLE] HOLD [AS filename] FORMAT EXL2K [PIVOT] [FORMULA]
```

where:

EXL2K

Creates an Excel-formatted output file that may include styling based on internal or external StyleSheets features. The extension on Windows platforms is .xht;

PIVOT

Creates an output file in Excel PivotTable format with an accompanying PivotTable cache file. The filetype of the Pivot Table file is XML; the extension on Windows platforms is .xml. For more information about this option, see [Using Excel Display Formats: XLSX, EXL2K, EXL97](#).

FORMULA

Creates an XHT output file including appropriate Excel formulas for all FOCUS numeric summary operations. For more information about this option, see [Using Excel Display Formats: XLSX, EXL2K, EXL97](#).

Usage Notes for EXL2K Output Files

Certain EXL2K format reports, such as Pivot Tables, generate multiple output files. The main document is returned to the browser (which opens it in Excel), and the secondary file (such as the pivot cache file in a Pivot Table report) is linked through a URL in the main file, to be retrieved by an HTTP request that Excel makes to the WebFOCUS servlet. When used with HOLD instead of PCHOLD, the output is a single web archive file with the same .xht suffix as a normal EXL2K HOLD file. In Excel, this file format is designated in the **Save** dialog as **Single File Web Page**.

- If you are using Excel 2002 or later, with WebFOCUS Version 7 Release 6.9 or earlier, you can avoid having to issue this second call by setting WEBARCHIVE=ON in any of the supported profiles or in the procedure (fex). Certain types of EXL2K reports, such as compound reports and reports with a table of contents (TOC), rely on the web archive format and automatically turn WEBARCHIVE ON.
- If you are using Excel 2002 or later, with WebFOCUS Version 7 Release 6.10 or higher, by default, the WEBARCHIVE setting is set to ON.

i **Note:** WEBARCHIVE=ON uses a file format that packages all of the documents into a single file.

For additional information about redirection settings for EXCEL formats with SET WEBARCHIVE=ON, see *Microsoft Excel Report Output Considerations* in the *WebFOCUS Security and Administration Manual*.

Font Support for EXL2K Format

The EXL2K (Excel 2000/2003) format supports fonts that are available on the WebFOCUS client. Be sure to verify the existence of a particular font on the client before displaying or saving a report in the EXL2K format.

National Language Support With EXL2K

Excel 2000/2003 users can select one of six languages as their default language when generating EXL2K formatted output. In addition to English, which is the automatic default, users can issue a SET command to select one of five other options.

Set the Default Language

```
SET EXL2KLANG=lang
```

where:

lang

Is one of the following: AME, FRE, SPA, GER, JPN or KOR.

You can code the SET EXL2KLANG in your user profile or include it in a FOCEXEC to override the default setting in the NLSCFG ERRORS file for a specific request.

Identifying Null Values in EXL2K Output Files

When an EXL2K report is run, and null values are retrieved for one or more fields, blank spaces are displayed by default in each cell of the report output for the empty (null) fields. This behavior is the result of SET EMPTYCELLS ON being set by default in the background of all EXL2K reports. If you want to identify null values with something other than blank spaces, a character string can be used to populate all empty fields in a report.

Identify Null Values in EXL2K Reports

To identify null values in EXL2K reports, use

```
ON TABLE SET NODATA character_string
```



```
ON TABLE SET EMPTYCELLS [ON|OFF]
```

where:

character_string

Is the string of characters displayed in the cells of the report for each field where null values are retrieved from the database. The maximum number of characters is 11. If the number of characters in the string exceeds the length of the output field, the additional characters will not be displayed. If special characters are used, the string must be enclosed in single quotes. SET EMPTYCELLS OFF must also be specified to make the SET NODATA command effective.

ON

Indicates that empty spaces are displayed in the cells of the report for each field where null values are retrieved from the database. ON is the default.

OFF

Indicates that zeros, or the character string specified with the SET NODATA command, will be displayed in the cells of the report for each field where null values are retrieved from the database. OFF must be specified when using SET NODATA.

Identifying Null Values in EXL2K Report Output

The following syntax utilizes the default behavior of ON TABLE SET EMPTYCELLS ON, which is set in the background:

```
TABLE FILE CAR
  SUM SALES BY COUNTRY ACROSS SEATS
  ON TABLE HOLD FORMAT EXL2K
END
```

The following output displays empty spaces in the cells of the report for each field where null values are retrieved from the database:

	A	B	C	D	E
1		SEATS			
2		2	4	5	
3	COUNTRY				
4	ENGLAND	0	0	12000	
5	FRANCE			0	
6	ITALY	25400	4800		
7	JAPAN		78030		
8	W GERMANY		8900	79290	
9					

The following syntax utilizes the SET NODATA command:

```
TABLE FILE CAR
  SUM SALES BY COUNTRY ACROSS SEATS
  ON TABLE SET NODATA 'n/a'
  ON TABLE SET EMPTYCELLS OFF
  ON TABLE HOLD FORMAT EXL2K
END
```

i Note: If you do not add SET EMPTYCELLS OFF, the SET NODATA command will be ignored.

The following output displays 'n/a' in the cells of the report for each field where null values are retrieved from the database:

	A	B	C	D	E
1		SEATS			
2		2	4	5	
3	COUNTRY				
4	ENGLAND	0	0	12000	
5	FRANCE	n/a	n/a	0	
6	ITALY	25400	4800	n/a	
7	JAPAN	n/a	78030	n/a	
8	W GERMANY	n/a	8900	79290	
9					

The following syntax turns off the default SET EMPTYCELLS behavior and does not use SET NODATA, which makes it impossible to distinguish null values from zero quantities:

```

TABLE FILE CAR
  SUM SALES BY COUNTRY ACROSS SEATS
  ON TABLE SET EMPTYCELLS OFF
  ON TABLE HOLD FORMAT EXL2K
END

```

The following output displays zeros in the cells of the report for each field where either null values are retrieved from the database or the quantity is zero:

	A	B	C	D	E
1		SEATS			
2		2	4	5	
3	COUNTRY				
4	ENGLAND	0	0	12000	
5	FRANCE	0	0	0	
6	ITALY	25400	4800	0	
7	JAPAN	0	78030	0	
8	W GERMANY	0	8900	79290	
9					

Displaying Formatted Numeric Values in EXL2K Report Output

Excel 2000/2003 workbooks generated by FOCUS EXL2K format contain the numeric formatting specified in the Master File for the data source or in a temporary field. FOCUS numeric values (such as currency) are translated to supported Excel formats and display properly in Excel 2000/2003.

When translating numeric formats from FOCUS to Excel, there must be a corresponding Excel format to translate to. If there is no corresponding format, then the value will be formatted in the closest matching Excel format or in Excel General format. For details, see [Using Excel Display Formats: XLSX, EXL2K, EXL97](#).

Displaying Formatted Numeric Data in EXL2K Report Output

The following example illustrates how formatted numeric data displays in a worksheet when using the EXL2K format. Note that the format for the Sales field (D16.2M—which represents floating point double-precision with two decimal places and a floating dollar sign) is translated to the corresponding Excel format.

```
DEFINE FILE GGSales
NEWDOll/D16.2M = DOLLARS;
END
```

```
SET PAGE-NUM=OFF
TABLE FILE GGSales
"Dollar Sales"
"Excel 2000 Spreadsheet"
" "
SUM NEWDOll AS 'Sales'
BY REGION AS 'Area'
BY CATEGORY
BY PRODUCT
WHERE REGION EQ 'Midwest' OR 'Northeast'
ON TABLE SET BYDISPLAY ON
  ON TABLE HOLD AS EXL2KNUM FORMAT EXL2K
ON TABLE SET STYLE *
TYPE=REPORT, GRID=OFF, FONT=TAHOMA, $
TYPE=HEADING, SIZE=14, COLOR=NAVY, $
TYPE=HEADING, LINE=2, SIZE=12, COLOR=RED, $
TYPE=TITLE, JUSTIFY=CENTER, STYLE=BOLD, $
TYPE=DATA, JUSTIFY=CENTER, $
TYPE=DATA, COLUMN=NEWDOll, JUSTIFY=RIGHT, $
ENDSTYLE
END
```

The output is:

D7 = 79670291

1 **Short Term Investments**

2 Excel 2000 Spreadsheet

	A	B	C	D	E	F	G
1							
2							
3							
4	Fund Manager	Type of Instrument	Instrument Holder	Fund Balance			
5	01005	CASH	COMM	\$7,200,830.00			
6	01005	CASH	GOVT	\$144,575,691.00			
7	01005	OVERNIGHT	GOVT	\$79,670,291.00			
8	01005	ST. NOTES	GOVT	\$221,001,921.00			
9	02005	OVERNIGHT	COMM	\$181,100,192.00			
10	02005	ST. NOTES	COMM	\$441,772,390.00			
11							
12							
13							
14							
15							

Sheet1

Unknown Zone

	A	B	C	D	E
1	Dollar Sales				
2	Excel 2000 Spreadsheet				
3					
4	Area	Category	Product	Sales	
5	Midwest	Coffee	Espresso	\$1,294,947.00	
6	Midwest	Coffee	Latte	\$2,883,566.00	
7	Midwest	Food	Biscotti	\$1,148,984.00	
8	Midwest	Food	Croissant	\$1,760,079.00	
9	Midwest	Food	Scone	\$1,495,420.00	
10	Midwest	Gifts	Coffee Grinder	\$666,622.00	
11	Midwest	Gifts	Coffee Pot	\$599,878.00	
12	Midwest	Gifts	Mug	\$1,086,943.00	
13	Midwest	Gifts	Thermos	\$577,906.00	
14	Northeast	Coffee	Capuccino	\$542,095.00	
15	Northeast	Coffee	Espresso	\$850,107.00	
16	Northeast	Coffee	Latte	\$2,808,855.00	
17	Northeast	Food	Biscotti	\$1,867,208.00	
18	Northeast	Food	Croissant	\$1,670,818.00	
19	Northeast	Food	Scone	\$907,171.00	
20	Northeast	Gifts	Coffee Grinder	\$509,200.00	
21	Northeast	Gifts	Coffee Pot	\$590,780.00	
22	Northeast	Gifts	Mug	\$1,144,211.00	
23	Northeast	Gifts	Thermos	\$604,098.00	
24					
25					
26					
27					
28					
29					

Notice that the values of the sort fields are repeated in the output; this presentation, which is particularly desirable in a worksheet, is controlled by the command `ON TABLE SET BYDISPLAY ON`. For details, see [Sorting Tabular Reports](#).

Usage Notes for Numeric Formats

The following formats are not supported in EXL2K. They will translate into Excel General format and possibly produce unpredictable results:

- Fixed Dollar (N) formats.
- Multiple format options. Only single format options are supported when using `FORMAT EXL2K`. For example, the formats I9C and I9B are supported, but I9BC is not.

The following applies to headings and footings with embedded numeric fields:

- If you embed a numeric field in a heading, subheading, footing, or subfooting of a report in an EXL2K report, the numeric field displays in Excel general format (text). To display a numeric field in Excel number format, you must set HEADALIGN=BODY in the StyleSheet.

Passing FOCUS Dates to Excel 2000/2003

Excel 2000/2003 workbooks generated by FOCUS EXL2K format contain the numeric formatting specified in the Master File for the data source or in a temporary field. FOCUS date formats (such as Smart Dates) are translated to supported Excel formats and display properly in Excel 2000/2003.

When translating date formats from FOCUS to Excel, there must be a corresponding Excel format to translate to. If there is no corresponding format, then the value will be formatted in the closest matching Excel format or in Excel General format. For details, see [Using Excel Display Formats: XLSX, EXL2K, EXL97](#).

By default, when FOCUS creates dates in Excel 2000 (EXL2K) format, the date formats that contain translated values such as month or day name are sent as formatted text, preserving the style defined for the report field. Numeric dates are passed to Excel 2000/2003 as standard date values, not as text. For information about passing translated date formats to Excel 2000/2003 as date values with format masks, see [Using Excel Display Formats: XLSX, EXL2K, EXL97](#).

Displaying Formatted Dates in EXL2K Report Output

The following example illustrates how customized dates display in a worksheet when using the EXL2K format.

- The format for **Month Hired** is defined in the request as MtYY (the month is represented as a 3-character abbreviation with an initial capital letter followed by a four-digit year).
- The format for **Years of Service** is defined as I4C, a four-digit integer with a comma if required. Both formats are properly displayed as defined in the worksheet.

```

SET PAGE-NUM=OFF
DEFINE FILE EMPLOYEE
  YRHIRED/YY = HIRE_DATE;
  MHIRED/MtYY = HIRE_DATE;
  TOTSVC/I4C = 2002 - YRHIRED;
END

```

```

TABLE FILE EMPLOYEE
"Employee Service Report for 2002"
"Excel 2000 Spreadsheet"
" "
PRINT FIRST_NAME AS 'First Name'
  MHIRED AS 'Month Hired'
  TOTSVC AS 'Years of Service'
BY LAST_NAME AS 'Last Name'
ON TABLE SET BYDISPLAY ON
ON TABLE HOLD FORMAT EXL2K
ON TABLE SET STYLE *
TYPE=REPORT, GRID=OFF, FONT=TAHOMA, $
TYPE=HEADING, SIZE=14, COLOR=NAVY, $
TYPE=HEADING, LINE=2, SIZE=12, COLOR=RED, $
TYPE=TITLE, JUSTIFY=CENTER, STYLE=BOLD, $
TYPE=DATA, JUSTIFY=CENTER, $
TYPE=DATA, COLUMN=TOTSVC, COLOR=BLUE, WHEN=TOTSVC GT 20, $
ENDSTYLE
END

```

The output is:

	A	B	C	D	E	F	G	H	I
1	Employee Service Report for 2002								
2	Excel 2000 Spreadsheet								
3									
4	Last Name	First Name	Month Hired	Years of Service					
5	BANNING	JOHN	Aug, 1982	20					
6	BLACKWOOD	ROSEMARIE	Apr, 1982	20					
7	CROSS	BARBARA	Nov, 1981	21					
8	GREENSPAN	MARY	Apr, 1982	20					
9	IRVING	JOAN	Jan, 1982	20					
10	JONES	DIANE	May, 1982	20					
11	MCCOY	JOHN	Jul, 1981	21					
12	MCKNIGHT	ROGER	Feb, 1982	20					
13	ROMANS	ANTHONY	Jul, 1982	20					
14	SMITH	MARY	Jul, 1981	21					
15	SMITH	RICHARD	Jan, 1982	20					
16	STEVENS	ALFRED	Jun, 1980	22					
17									

The command `ON TABLE SET BYDISPLAY ON` ensures that sort fields are repeated in each worksheet cell. For details, see [Sorting Tabular Reports](#).

Usage Notes for Date Formats

The following formats are not supported in EXL2K. They will translate into Excel General format and possibly produce unpredictable results:

- YY, Y, M, D, JUL, and I2MT.
- Any date format with a Q (quarter).
- Any packed-decimal (P) date formats.
- Any alphanumeric (A) date formats.

Using Date Separators in Excel

In order to use a "-" as a separator between month, day, and year in Excel 2000/2003, you must change the default date separator for Windows. This setting can be located under Regional Options in the Control Panel.

Passing Dates With Translated Text to Excel 2000/2003

Some translated dates can be sent to Excel 2000/2003 as standard date values with format masks, enabling Excel to use them in functions, formulas, and sort sequences. The `SET EXL2KTXDATE` command allows you to specify that translated dates should be sent as date values with format masks instead of text values.

Pass Translated Dates to Excel 2000/2003 as Date Values

```
SET EXL2KTXTDATE = {TEXT|VALUE}
```

where:

TEXT

Passes date values that contain text to Excel 2000/2003 as formatted text. TEXT is the default value.

VALUE

Passes the types of translated date values that contain text and are supported Excel date formats to Excel 2000/2003 as standard date values with text format masks applied.

Usage Notes for SET EXL2KTXTDATE

- The following date formats are not supported in EXL2K. They will translate into Excel General format and possibly produce unpredictable results:
 - JUL, YYJUL, and I2MT.
 - Dates stored as a packed or alphanumeric field with date display options.
- Excel only supports mixed-case, not all uppercase or all lowercase for text dates. When EXL2KTXTDATE is set to VALUE, all FOCUS date formats containing text will present in EXL2K as mixed-case, regardless of the casing parameters defined in the FOCUS format. For example, MTRDY will generate the date string JANUARY 2, 10 in standard FOCUS, but when sent to EXL2K as a date value, it will be presented as January 2, 10.

Passing Dates With Translated Text to Excel

2000/2003

The following request against the GGSales data source creates the date January 1, 2010 and converts it to four date formats with translated text:

```

SET EXL2KTXTDATE=TEXT
DEFINE FILE GGSales
NEWDATE/MDYY = '01/01/2010';
WRMtrDY/WRMtrDY = NEWDATE;
wDMTY/wDMTY= NEWDATE;
wrDMTRY/wrDMTRY= NEWDATE;
wrYMtrD/wrYMtrD= NEWDATE;
END
TABLE FILE GGSales
SUM DATE NOPRINT
NEWDATE WRMtrDY wDMTY wrDMTRY wrYMtrD
ON TABLE HOLD FORMAT EXL2K
END

```

The following table shows how the dates should appear with EXL2KTXTDATE set to TEXT and to VALUE.

FOCUS Format	SET EXL2KTXTDATE=TEXT		SET EXL2KTXTDATE=VALUE	
	EXL2K Displays:	EXL2K Value:	EXL2K Displays:	EXL2K Value:
WRMtrDY	FRIDAY, January 1 10	FRIDAY, January 1 10	Friday, January 1 10	1/1/2010
wDMTY	Fri, 1 JAN 10	Fri, 1 JAN 10	Fri, 1 Jan 10	1/1/2010
wrDMTRY	Friday, 1 JANUARY 10	Friday, 1 JANUARY 10	Friday, 1 January 10	1/1/2010
wrYMtrD	Friday, 10 January 1	Friday, 10 JANUARY 1	Friday, 10 January 1	1/1/2010

With SET EXL2KTXTDATE=TEXT, in EXL2K report output all the cells with month or day translation are sent as text, and all month and day names are in the case specified by the FOCUS format. The output is:

	A	B	C	D	E
1	NEWDATE	WRMtrDY	wDMTY	wrDMTRY	wrYMtrD
2	01/01/2010	FRIDAY, January 1 10	Fri, 1 JAN 10	Friday, 1 JANUARY 10	Friday, 10 January 1

With SET EXL2KTXTDATE=VALUE, in EXL2K report output all of the cells have a date value with format masks, and all month and day names are in mixed-case, regardless of how the case has been specified in the FOCUS format. The output is:

	A	B	C	D	E
1	NEWDATE	WRMtrDY	wDMTY	wrDMTRY	wrYMtrD
2	01/01/2010	Friday, January 1 10	Fri, 1 Jan 10	Friday, 1 January 10	Friday, 10 January 1

Passing Dates Without a Day Component

Date formats that do not specify the day value explicitly are defined as the date value of the first day of the month. Therefore, the value placed in the cell may be different from the day component value in the source data field and may produce unexpected results when used for sorting or date calculations in an Excel formula.

The following table shows how FOCUS date formats are represented in EXL2K report output. The table shows how the value is preserved in the cell and how the display is generated using the format mask that corresponds to the FOCUS date format.

```
DATEFLD/MDYY = '01/02/2010'
```

FOCUS Format	SET EXL2KTXTDATE=TEXT		SET EXL2KTXTDATE=VALUE	
	EXL2K Displays:	EXL2K Value:	EXL2K Displays:	EXL2K Value:
DMYY	02/01/2010	1/2/2010	02/01/2010	1/2/2010
MY	01/10	1/1/2010	01/10	1/1/2010
MTY	JAN, 10	JAN, 10	Jan, 10	1/1/2010

FOCUS Format	SET EXL2KTXTDATE=TEXT		SET EXL2KTXTDATE=VALUE	
	EXL2K Displays:	EXL2K Value:	EXL2K Displays:	EXL2K Value:
MTDY	JAN 2, 10	JAN 2, 10	Jan 2, 10	1/2/2010

Passing FOCUS Dates With and Without a Day Component to Excel 2000/2003

The following request against the GGSales data source creates the date January 2, 2010 and passes it to Excel 2000/2003 with formats MDYY, DMY, MY, and MTDY:

```
SET EXL2KTXTDATE=TEXT
DEFINE FILE GGSales
NEWDATE/MDYY = '01/02/2010';
END
TABLE FILE GGSales
SUM DATE NOPRINT
NEWDATE AS 'MDYY' NEWDATE/DMY AS 'DMY' NEWDATE/MY
      AS 'MY' NEWDATE/MTDY AS 'MTDY' NEWDATE/MTDY AS 'MTDY'
ON TABLE HOLD FORMAT EXL2K
END
```

With EXL2KTXTDATE=TEXT, columns D and E have a text values, not date values. The values are displayed in uppercase as specified by the FOCUS formats (MTY and MTDY):

	A	B	C	D	E
1	MDYY	DMY	MY	MTY	MTDY
2	01/02/2010	02/01/2010	01/10	JAN, 10	JAN 2, 10

With EXL2KTXTDATE=VALUE, columns D and E have actual date values with format masks, displayed by Excel 2000 in mixed-case. Since the MTY format does not have a day component, the date value stored is the first of January 2010 (1/1/2010), not the second of January 2010 (1/2/2010):

	A	B	C	D	E
1	MDYY	DMY	MY	MTY	MTDY
2	01/02/2010	02/01/2010	01/10	Jan, 10	Jan 2, 10

Passing Date Components for Use in EXL2K FORMULA Reports

Dates formatted as individual components (for example, D, Y, M, W) are passed to Excel 2000/2003 as numeric values that can be used as parameters to Excel date functions. The values are passed as general text format that are recognized by Excel 2000/2003 as numbers. These values are passed to Excel in the same format regardless of the setting for EXL2KTXDATE.

Passing Numeric Date Components to Excel 2000/2003

The following request against the GGSales data source creates the date January 1, 2010 and extracts numeric date components, passing them to Excel 2000/2003:

```
SET EXL2KTXDATE=VALUE
DEFINE FILE GGSales
NEWDATE/MDYY = '01/01/2010';
D/D= NEWDATE;
Y/Y = NEWDATE;
W/W=NEWDATE;
w/w=NEWDATE;
M/M = NEWDATE;
YY/YY = NEWDATE;
END
TABLE FILE GGSales
SUM DATE NOPRINT
NEWDATE D Y W w M YY
ON TABLE HOLD FORMAT EXL2K
END
```

With SET EXL2KTXDATE=VALUE, the output is:

	A	B	C	D	E	F	G
1	NEWDATE	D	Y	W	w	M	YY
2	01/01/2010	01	10	5	5	01	2010

Passing Quarter Formats

Date formats that contain a Quarter component are always passed to Excel as text strings since Excel does not support Quarter formats.

Passing Dates With a Quarter Component to Excel 2000/2003

The following request against the GGSales data source creates the date January 1, 2010 and converts it to date formats that contain a Quarter component:

```
SET EXL2KTXDATE=VALUE
DEFINE FILE GGSales
NEWDATE/MDYY = '01/01/2010';
Q/Q= NEWDATE;
QY/QY = NEWDATE;
YBQ/YBQ=NEWDATE;
END
TABLE FILE GGSales
SUM DATE NOPRINT
NEWDATE Q QY YBQ
ON TABLE HOLD FORMAT EXL2K
END
```

Even with SET EXL2KTXDATE=VALUE, in the EXL2K report output, the cells containing dates with Quarter components have General format. To see this, open the Format Cells dialog box.

The output is:

	A	B	C	D
1	NEWDATE	Q	QY	YBQ
2	01/01/2010	Q1	Q1 10	10 Q1

Passing Date Components Defined as Translated Text

Date formats that do not contain sufficient information to present the valid date result in Excel are not translated to a value, including formats that do not contain year and/or month information. These dates will continue to be sent to Excel 2000/2003 as text regardless of the SET EXL2KTXDATE setting. In the absence of complete information, the year defaults to the current year, so the value sent would be incorrect if this type of format was passed as a date value. The following formats will not be sent as values:

- MT, MTR, Mt, Mtr
- W, w, WR, wr

Note that since these values are always sent as text, the casing defined in the FOCUS format is applied in the resulting cell.

Passing Date Components Defined as Translated Text to Excel 2000/2003

The following request against the GGSales data source creates the date January 1, 2010 and converts it to date formats that are defined as either month name or day name:

```
SET EXL2KTXDATE=VALUE
DEFINE FILE GGSales
NEWDATE/MDYY = '01/01/2010';
MT/MT= NEWDATE;
MTR/MTR= NEWDATE;
Mtr/Mtr = NEWDATE;
WR/WR = NEWDATE;
wr/wr = NEWDATE;
END
TABLE FILE GGSales
SUM DATE NOPRINT
NEWDATE MT MTR Mtr WR wr
ON TABLE HOLD FORMAT EXL2K
END
```

In Excel 2000/2003, the cells containing the days have General format. To see this, open the Format Cells dialog box.

The output is:

	A	B	C	D	E	F
1	NEWDATE	MT	MTR	Mtr	WR	wr
2	01/01/2010	Jan	January	January	FRIDAY	Friday

Controlling Column Width and Wrapping in EXL2K Report Output

Data wrapping, column width, and the scroll area can be controlled in an Excel 2000/2003 worksheet when using FORMAT EXL2K. You can:

- Turn data wrapping on. The default behavior is for all data to wrap according to a default column width that is determined by Excel.
- Turn data wrapping off. This setting allows columns to expand to the length of the data value. The column width is determined by Excel, but should be wide enough to fit the longest data value in the column. If a portion of the data is hidden, you can adjust the column width in Excel after the worksheet has been generated.
- Turn data wrapping off and set the column width at the same time. If a data value is wider than the specified width of the column, a portion of the data will be hidden from view. You can adjust the column width in Excel after the worksheet has been generated.
- Specify the exact width of a column with data wrapping on.

Wrap Data in EXL2K Report Output

```
TYPE=REPORT, [COLUMN=column,] WRAP=value, $
```

where:

column

Designates a particular column to apply wrapping behavior to. If COLUMN is not included in the declaration, wrapping will be applied to the entire report.

value

Is one of the following:

ON

Turns on data wrapping. ON is the default value. With this setting, the column width is determined by the client (Excel). Data wraps if it exceeds the width of the column and the row's height expands to meet the new height of the wrapped data.

OFF

Turns off data wrapping. This setting adjusts the column width of the largest data value in the column. Data will not wrap in any cell in the column.

n

Represents a specific numeric value that the column width can be set to. The value represents the measure specified with the UNITS parameter (the default is inches).

This setting implies ON. However, the column width is set to the specified width unless the data is wider than the column width, in which case, wrapping will occur as for ON.

Set Column Width in EXL2K Report Output

```
TYPE=REPORT, [COLUMN=column,] SQUEEZE={ON|OFF|n}, $
```

where:

column

Identifies a particular column. If COLUMN is not included in the declaration, default SQUEEZE behavior is applied to the entire report.

n

Represents a specific numeric value that the column width can be set to. The value represents the measure specified with the UNITS parameter (the default is inches).

This is the most commonly used SQUEEZE setting in an EXL2K report.

i Note:

- ON/OFF settings for SQUEEZE are not meaningful for EXL2K, and both produce the default behavior.
- SQUEEZE = *n* turns off data wrapping. If a data value is wider than the specified width of the column, it is hidden from view. You can adjust column width in Excel after the worksheet has been generated.
- SQUEEZE is not supported for columns created with the OVER phrase.

Controlling Column Width and Wrapping in EXL2K Report Output

The following example illustrates how to turn on and turn off data wrapping in a column and how to set the column width for a particular column. The UNITS in this example are set to inches (the default).

```
DEFINE FILE CAR
MYDATE/MDY='10/22/60';
RCD/D14.3=RETAIL_COST;
VERYLONG/A80='Subtract dealer cost from retail cost to calculate
profit.';
END
```

```
TABLE FILE CAR
PRINT MYDATE RCD
VERYLONG AS 'Default' VERYLONG AS 'WRAP=OFF'
VERYLONG AS 'WRAP=4.1' VERYLONG AS 'WRAP=2'
VERYLONG AS 'SQUEEZE=2' SALES
BY COUNTRY
ON TABLE HOLD FORMAT EXL2K
ON TABLE SET STYLE *
TYPE=DATA, COLUMN=MYDATE, JUSTIFY=CENTER, $
1. TYPE=REPORT, COLUMN=VERYLONG(2), WRAP=OFF, $
2. TYPE=REPORT, COLUMN=VERYLONG(3), WRAP=4.1, $
3. TYPE=REPORT, COLUMN=VERYLONG(4), WRAP=2, $
4. TYPE=REPORT, COLUMN=VERYLONG(5), SQUEEZE=2, $
END
```

where:

1. Identifies the column titled "WRAP=OFF" and turns off data wrapping for that column.
2. Identifies the column titled "WRAP=4.1" and sets the column width to 4.1 inches with data wrapping on.
3. Identifies the column titled "WRAP=2" and sets the column width to 2 inches with data wrapping on.
4. Identifies the column titled "SQUEEZE=2" and sets the column width to 2 inches with data wrapping off.

i Note: The column titled "Default" illustrates the default column width and wrapping behavior.

Since the output is wider than this page, it is shown in two sections. The following output displays the "Default", "WRAP=OFF", and "WRAP=4.1" columns:

D1		Default	
	D	E	F
1	Default	WRAP=OFF	WRAP=4.1
2	Subtract dealer cost from retail cost to calculate profit.	Subtract dealer cost from retail cost to calculate profit.	Subtract dealer cost from retail cost to calculate profit.
3	Subtract dealer cost from retail cost to calculate profit.	Subtract dealer cost from retail cost to calculate profit.	Subtract dealer cost from retail cost to calculate profit.
4	Subtract dealer cost from retail cost to calculate profit.	Subtract dealer cost from retail cost to calculate profit.	Subtract dealer cost from retail cost to calculate profit.
5	Subtract dealer cost from retail cost to calculate profit.	Subtract dealer cost from retail cost to calculate profit.	Subtract dealer cost from retail cost to calculate profit.
6	Subtract dealer cost from retail cost to calculate profit.	Subtract dealer cost from retail cost to calculate profit.	Subtract dealer cost from retail cost to calculate profit.
7	Subtract dealer cost from retail cost to calculate profit.	Subtract dealer cost from retail cost to calculate profit.	Subtract dealer cost from retail cost to calculate profit.
8	Subtract dealer cost from retail cost to calculate profit.	Subtract dealer cost from retail cost to calculate profit.	Subtract dealer cost from retail cost to calculate profit.
9	Subtract dealer cost from retail cost to calculate profit.	Subtract dealer cost from retail cost to calculate profit.	Subtract dealer cost from retail cost to calculate profit.
10	Subtract dealer cost from retail cost to calculate profit.	Subtract dealer cost from retail cost to calculate profit.	Subtract dealer cost from retail cost to calculate profit.

The following output displays the "WRAP=2", and "SQUEEZE=2" columns:

	D1	= Default	
	F	G	H
1	WRAP=4.1	WRAP=2	SQUEEZE=2
2	Subtract dealer cost from retail cost to calculate profit.	Subtract dealer cost from retail cost to calculate profit.	Subtract dealer cost from retail c
3	Subtract dealer cost from retail cost to calculate profit.	Subtract dealer cost from retail cost to calculate profit.	Subtract dealer cost from retail c
4	Subtract dealer cost from retail cost to calculate profit.	Subtract dealer cost from retail cost to calculate profit.	Subtract dealer cost from retail c
5	Subtract dealer cost from retail cost to calculate profit.	Subtract dealer cost from retail cost to calculate profit.	Subtract dealer cost from retail c
6	Subtract dealer cost from retail cost to calculate profit.	Subtract dealer cost from retail cost to calculate profit.	Subtract dealer cost from retail c
7	Subtract dealer cost from retail cost to calculate profit.	Subtract dealer cost from retail cost to calculate profit.	Subtract dealer cost from retail c
8	Subtract dealer cost from retail cost to calculate profit.	Subtract dealer cost from retail cost to calculate profit.	Subtract dealer cost from retail c
9	Subtract dealer cost from retail cost to calculate profit.	Subtract dealer cost from retail cost to calculate profit.	Subtract dealer cost from retail c
10	Subtract dealer cost from retail cost to calculate profit.	Subtract dealer cost from retail cost to calculate profit.	Subtract dealer cost from retail c

Locking Columns in EXL2K Report Output

Using StyleSheet attributes, you can lock Excel workbook values so they are read-only. These attributes apply to all EXL2K formats including EXL2K, EXL2K PIVOT, and EXL2K FORMULA.

Enable Worksheet Locking

To enable locking, use the following attributes:

```
TYPE=REPORT, PROTECTED={ON|OFF}, [LOCKED={ON|OFF}], $
```

where:

TYPE=REPORT, PROTECTED=ON

Is necessary to enable worksheet locking. PROTECTED=OFF is the default. If you omit the LOCKED=OFF attribute, the entire worksheet is locked.

LOCKED=ON

Locks the entire worksheet. ON is the default value.

LOCKED=OFF

Unlocks the worksheet as a whole, but enables you to lock or unlock specific cells or groups of cells.

Lock Specific Cells Within a Worksheet

Once you include the following declaration in your StyleSheet, you can specify the LOCKED attribute for specific cells or groups of cells:

```
TYPE=REPORT, PROTECTED=ON, LOCKED=OFF,$
```

To lock specific parts of the worksheet, add the LOCKED=ON attribute to the StyleSheet declaration for the cells you want to lock.

```
TYPE=type, [ COLUMN=columnspec ] ,LOCKED={ON|OFF},$
```

where:

type

Is the type of element that describes the cells to be locked.

columnspec

Is a valid column specification.

Locking an Entire EXL2K Workbook

The following request locks the entire workbook because the StyleSheet declarations include the following declaration:

```
TYPE=REPORT, PROTECTED=ON, $
```

The request is:

```
TABLE FILE CAR  
HEADING
```

```

"Profit By Car "
" "
SUM RETAIL_COST AND DEALER_COST AND
COMPUTE PROFIT/D12.2 = RETAIL_COST - DEALER_COST;
BY CAR
ON TABLE SET PAGE-NUM OFF
ON TABLE HOLD AS EXLFORM1 FORMAT EXL2K
ON TABLE SET STYLE *
TYPE=REPORT, COLOR=BLUE, BACKCOLOR=SILVER, SIZE=9,$
TYPE=REPORT, PROTECTED=ON, $
TYPE=HEADING, STYLE=BOLD, SIZE=14, $
TYPE=TITLE, STYLE=BOLD, SIZE=11,$
ENDSTYLE
END

```

You cannot edit any value on the worksheet. Any attempt to do so displays a message that the sheet is protected:

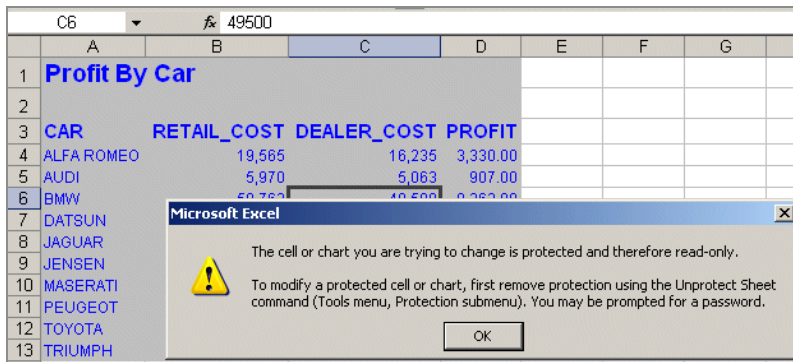

Locking a Single Column on an EXL2K Workbook

The following request locks the second column (RETAIL_COST) because the StyleSheet declarations include the following declarations:

```

TYPE=REPORT, PROTECTED=ON, LOCKED=OFF, $
TYPE=DATA, COLUMN=2, LOCKED=ON,$

```

The request is:

```

TABLE FILE CAR
HEADING

```

```

"Profit By Car "
" "
SUM RETAIL_COST AND DEALER_COST AND
COMPUTE PROFIT/D12.2 = RETAIL_COST - DEALER_COST;
BY CAR
ON TABLE SET PAGE-NUM OFF
ON TABLE HOLD AS EXLFORM2 FORMAT EXL2K
ON TABLE SET STYLE *
TYPE=REPORT, COLOR=BLUE, BACKCOLOR=SILVER, SIZE=9,$
TYPE=REPORT, PROTECTED=ON, LOCKED=OFF,$
TYPE=HEADING, STYLE=BOLD, SIZE=14, $
TYPE=TITLE, STYLE=BOLD, SIZE=11,$
TYPE=DATA, COLUMN=2, LOCKED=ON,$
ENDSTYLE
END

```

You cannot edit any value in column 2, although you can edit values in other columns. Any attempt to edit a value in column 2 displays a message that the cells are protected:

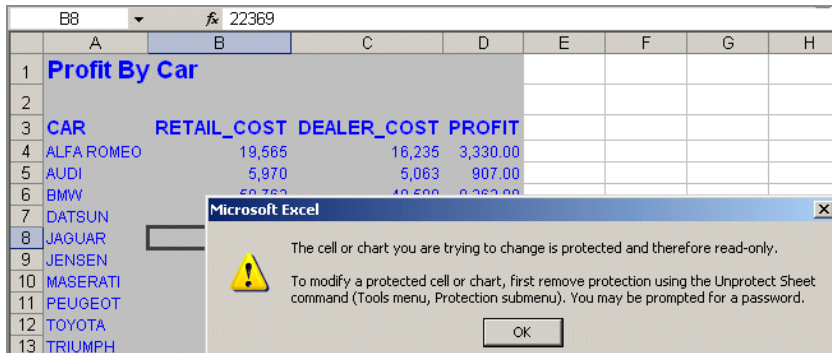

Generating Native Excel Formulas in EXL2K Report Output

When you display or save a tabular report request using EXL2K FORMULA, the resulting worksheet contains an Excel formula that computes and displays the results of any type of summed information (such as column totals, row totals, subtotals, and calculated values), rather than static numbers. Worksheets saved using the EXL2K FORMULA format are interactive, allowing for "what if" scenarios that immediately reflect any additions or modifications made to the data.

The EXL2K FORMULA format is supported for the FOCUS TABLE commands: ROW-TOTAL, COLUMN-TOTAL, SUB-TOTAL, SUBTOTAL, SUMMARIZE, RECOMPUTE, and COMPUTE, and for calculations performed by functions. See [Using Excel Display Formats: XLSX, EXL2K, EXL97](#).

EXL2K FORMULA is *not* supported with PivotTables (EXL2K PIVOT), with Excel 97 (EXL97), or with financial reports created with the Financial Report Painter or the underlying Financial Modeling Language (FML).

Save Reports as FORMAT EXL2K FORMULA

Add the following syntax to your request to take advantage of Excel formulas in your workbook:

```
ON TABLE HOLD FORMAT EXL2K FORMULA
```

where:

HOLD

Saves the output for reuse in an Excel 2000/2003 worksheet. For details, see [Saving and Reusing Your Report Output](#).

Generating Native Excel Formulas for Column Totals

The following example illustrates the translation of a column total in a report request into an Excel formula when using format EXL2K FORMULA. Note that the formatting of the column total (TYPE=GRANDTOTAL) is retained in the Excel 2000 spreadsheet.

When you select the total in the report, the equation =SUM(B4:B7) appears in the formula bar, representing the column total as a sum of cell ranges.

```
TABLE FILE CENTORD
HEADING
"Projected Return By Region"
" "
SUM LINE_COGS AS 'RETURN'
BY REGION AS 'REGION'
ON TABLE COLUMN-TOTAL
ON TABLE HOLD AS EXL2K5 FORMAT EXL2K FORMULA
```

```

ON TABLE SET STYLE *
TYPE=REPORT, COLOR=BLUE, BACKCOLOR=SILVER, SIZE=9,$
TYPE=HEADING, STYLE=BOLD, SIZE=14,$
TYPE=TITLE, STYLE=BOLD+UNDERLINE, SIZE=10,$
TYPE=GRANDTOTAL, STYLE=BOLD,$
ENDSTYLE
END

```

The output is:

B8		fx =SUM(B4:B7)	
	A	B	
1	Projected Return By Region		
2			
3	REGION	RETURN	
4	EAST	233,492,476.00	
5	NORTH	156,931,554.00	
6	SOUTH	184,491,442.00	
7	WEST	71,649,432.00	
8	TOTAL	646,564,904.00	

Generating Native Excel Formulas for Row Totals

This request calculates totals for line price and quantity across regions. The row totals are represented as sums of cell ranges.

```

TABLE FILE CENTORD
HEADING
"Projected Line Cost Across Region"
" "
SUM LINEPRICE AND QUANTITY
ACROSS REGION AS 'Region'
BY STORENAME
WHERE REGION EQ 'EAST' OR 'NORTH'
ON REGION ROW-TOTAL AS 'TOTAL'
ON TABLE COLUMN-TOTAL AS 'TOTAL'
ON TABLE HOLD AS EXL2K6 FORMAT EXL2K FORMULA
ON TABLE SET STYLE *
TYPE=REPORT, COLOR=BLUE, BACKCOLOR=SILVER, SIZE=9,$
TYPE=HEADING, STYLE=BOLD, SIZE=14,$
TYPE=TITLE, STYLE=BOLD, SIZE=11,$
TYPE=SUBTOTAL, STYLE=BOLD, $

```

```

TYPE=GRANDTOTAL, STYLE=BOLD, SIZE=11,$
TYPE=ACROSSTITLE, STYLE=BOLD, SIZE=11, JUSTIFY=LEFT,$
TYPE=ACROSSVALUE, STYLE=BOLD, SIZE=10, JUSTIFY=CENTER,$
ENDSTYLE
END

```

The output highlights the formula that calculates the row total in cell G11=C11+E11:

G11 =C11+E11							
	A	B	C	D	E	F	G
1	Projected Line Cost Across Region						
2							
3		Region					
4		EAST		NORTH		TOTAL	
5	Store	Line		Line		Line	
6	Name:	Total	Quantity:	Total	Quantity:	Total	Quantity:
7	eMart	\$48,833,656.98	196,084	\$114,336,646.64	457,064	\$163,170,303.62	653,148
8	Audio Expert	\$136,936,955.91	531,280	\$8,549,478.68	32,566	\$145,486,434.59	563,846
9	AV VideoTown	\$27,578,810.97	109,504	\$17,113,451.48	70,330	\$44,692,262.45	179,834
10	City Video	\$5,911,253.15	24,565	\$9,387,798.14	36,704	\$15,299,051.29	61,269
11	Consumer Merchandise	\$20,298,468.86	80,701	\$5,181,690.34	20,203	\$25,480,159.20	100,904
12	TV City	\$22,034,204.35	89,148	\$23,791,473.06	90,332	\$45,825,677.41	179,480
13	Web Sales	\$4,027,582.48	12,225			\$4,027,582.48	12,225
13	TOTAL	\$265,620,932.70	1,043,507	\$178,360,538.34	707,199	\$443,981,471.04	1,750,706

Generating Native Excel Formulas for Calculated Values

This request totals the columns for retail cost and dealer cost and calculates the value of a field called PROFIT by subtracting the dealer cost from the retail cost.

The formula for the calculated values is generated by translating the internal form of the FOCUS expression (COMPUTE PROFIT/D12.2 = RC - DC;) into an Excel formula. In this example, the formulas appear in cells B14, C14, and D14.

```

TABLE FILE CAR
ON TABLE SET PAGE-NUM OFF
SUM RC AND DC AND
COMPUTE PROFIT/D12.2 = RC - DC;
BY CAR
HEADING
"Profit By Car"
" "
ON TABLE COLUMN-TOTAL
ON TABLE HOLD FORMAT EXLL2K FORMULA
ON TABLE SET STYLE *

```

```

TYPE=REPORT, COLOR=BLUE, BACKCOLOR=SILVER, SIZE=9,$
TYPE=HEADING, STYLE=BOLD, SIZE=14, $
TYPE=TITLE, STYLE=BOLD, SIZE=11,$
TYPE=GRANDTOTAL, STYLE=BOLD, SIZE=11,$
ENDSTYLE
END

```

The following output highlights the formula that calculates for the column total of PROFIT: D14=SUM(D4:D13).

	A	B	C	D
1	Profit By Car			
2				
3	CAR	RETAIL_COST	DEALER_COST	PROFIT
4	ALFA ROMEO	19,565	16,235	3,330.00
5	AUDI	5,970	5,063	907.00
6	BMW	58,762	49,500	9,262.00
7	DATSUN	3,139	2,626	513.00
8	JAGUAR	22,369	18,621	3,748.00
9	JENSEN	17,850	14,940	2,910.00
10	MASERATI	31,500	25,000	6,500.00
11	PEUGEOT	5,610	4,631	979.00
12	TOYOTA	3,339	2,886	453.00
13	TRIUMPH	5,100	4,292	808.00
14	TOTAL	173,204	143,794	29,410.00

Generating a Native Excel Formula for a Function

The following illustrates how functions are translated to Excel 2000/2003 reports. The function DMOD divides ACCTNUMBER by 1000 and returns the remainder to LAST3_ACCT. The Excel formula corresponds to this, =TRUNC((MOD(\$C3,(1000)))).

```

TABLE FILE EMPLOYEE
PRINT ACCTNUMBER AS 'Account Number' AND COMPUTE
LAST3_ACCT/I3L = DMOD(ACCTNUMBER, 1000, LAST3_ACCT);
BY LAST_NAME AS 'Last Name'
BY FIRST_NAME AS 'First Name'
WHERE (ACCTNUMBER NE 000000000) AND (DEPARTMENT EQ 'MIS');
ON TABLE HOLD FORMAT EXL2K FORMULA
ON TABLE SET STYLE *
TYPE=TITLE, SIZE=12, STYLE=BOLD, $

```

```
ENDSTYLE
END
```

The output is:

	A	B	C	D	E	F	G	H	I
1	Last Name	First Name	Account Number	LAST3_ACCT					
2	BLACKWOOD	ROSEMARIE	122850108	108					
3	CROSS	BARBARA	163800144	144					
4	GREENSPAN	MARY	150150302	302					
5	JONES	DIANE	040950036	036					
6	MCCOY	JOHN	109200096	096					
7	SMITH	MARY	027300024	024					
8									
9									
10									
11									
12									
13									
14									
15									
16									
17									

Generating a Formula With Recomputed Values

If your report contains a calculated value (generated by the COMPUTE or RECOMPUTE command), all of the fields referenced by the calculated value must be displayed in the report in order for cell references to be included in the formula. If a referenced column is not displayed in the workbook, the data value will be placed in the formula, rather than a cell reference. In the case of recompute, the value used may be an incorrect value from the last detail record of the sort break.

Generating a Formula With Recomputed Values

The following request computes the difference (DIFF) by subtracting budgeted dollars from dollar sales. The budgeted dollars field used in the expression is not included in the SUM command. The value of DIFF is recomputed on the region level:

```
TABLE FILE GGSALES
HEADING
"Profit By Region"
```

```

" "
SUM DOLLARS
COMPUTE DIFF/I9=DOLLARS - BUDDOLLARS;
BY REGION
BY CATEGORY
ON REGION RECOMPUTE
ON TABLE HOLD FORMAT EXL2K FORMULA
END

```

The output shows that the formula is subtracting a data value that is not displayed on the worksheet. It is actually the BUDDOLLARS value from the previous row:

D7		fx =TRUNC(\$C7 -2887620)			
	A	B	C	D	E
1	Profit By Region				
2					
3	Region	Category	Dollar Sales	DIFF	
4	Midwest	Coffee	4178513	92481	
5		Food	4338271	117550	
6		Gifts	2883881	-3739	
7	*TOTAL Midwest		11400665	8513045	
8	Northeast	Coffee	4164017	-88445	
9		Food	4379994	-73913	
10		Gifts	2848289	-22263	
11	*TOTAL Northeast		11392300	8521748	
12	Southeast	Coffee	4415408	-16021	
13		Food	4308731	-100557	
14		Gifts	2986240	18986	
15	*TOTAL Southeast		11710379	8743125	
16	West	Coffee	4473517	-50446	
17		Food	4202337	19093	
18		Gifts	2977092	42786	
19	*TOTAL West		11652946	8718640	
20	TOTAL		46156290	-64488	

If you change the SUM command to the following, the formula can be recomputed correctly:

```
SUM DOLLARS BUDDOLLARS
```

The formula generated with the new SUM command contains cell references for both fields used in the calculation:

E7 fx =TRUNC(\$C7 -\$D7)					
	A	B	C	D	E
1	Profit By Region				
2					
3	Region	Category	Dollar Sales	Budget Dollars	DIFF
4	Midwest	Coffee	4178513	4086032	92481
5		Food	4338271	4220721	117550
6		Gifts	2883881	2887620	-3739
7	*TOTAL Midwest		11400665	11194373	206292
8	Northeast	Coffee	4164017	4252462	-88445
9		Food	4379994	4453907	-73913
10		Gifts	2848289	2870552	-22263
11	*TOTAL Northeast		11392300	11576921	-184621
12	Southeast	Coffee	4415408	4431429	-16021
13		Food	4308731	4409288	-100557
14		Gifts	2986240	2967254	18986
15	*TOTAL Southeast		11710379	11807971	-97592
16	West	Coffee	4473517	4523963	-50446
17		Food	4202337	4183244	19093
18		Gifts	2977092	2934306	42786
19	*TOTAL West		11652946	11641513	11433
20	TOTAL		46156290	46220778	-64488

Translation Support for FORMAT EXL2K FORMULA

- All standard operators are supported. These include arithmetic operators, relational operators, string operators, IF/THEN/ELSE, and logical operators. However, column notation is not supported.

The IS-PRESENT, IS-MISSING, CONTAINS, and OMITS operators are not supported. In addition the logical operators (AND, OR) are not supported within IF/THEN/ELSE statements.

- The following functions are supported:

ABS, ARGLEN, ATODBL, BYTVAL, CHARGET, CTRAN, CTRFLD, DECODE DMOD, DOWK, DOWKI, DOWKL, DOWKLI, EDIT (1 argument variant only), EXP, EXPN, FMOD, HEXBYT, HHMMSS, IMOD, INT, LCWORD, LJUST, LOCASE, LOG, MAX, MIN, OVLAY, POSIT, RDUNIF, RANDOM, RJUST, SQRT, SUBSTR, TODAY, TODAYI, UPCASE, YM. The EDIT function is not supported for editing strings.

If you use the COMPUTE command with an unsupported function, an error message is displayed.

- EXL2K FORMULA is not supported with the following FOCUS commands and phrases:
 - DEFINE.
 - OVER.
 - FOR.
 - NOPRINT.
 - Multiple display (PRINT, LIST, SUM, and COUNT) commands.
 - SEQUENCE StyleSheet attribute.
 - RECAP.
 - SET HIDENULLACRS.
 - SET SUBTOTALS = ABOVE.
 - LAST.
- If your report contains a calculated value (generated by the COMPUTE or RECOMPUTE command), all of the fields referenced by the calculated value must be displayed in the report in order for a cell reference to be included in the formula. If the referenced column is not displayed in the workbook, the data value will be placed in the formula rather than a cell reference.
- Formulas for ROW-TOTALS are represented by addition of specific cells, while formulas for COLUMN-TOTALS are represented as sums of cell ranges. For example, =SUM(G2:G10).
- A formula for a calculated value is generated by translating the internal form of the FOCUS expression into an Excel formula.
- The setting BYDISPLAY ON is recommended, otherwise the sort field value will not be available on all rows for recalculations.
- Excel 2000/2003 formulas are limited to 1024 characters. Therefore, the translation to an Excel formula will fail if a FOCUS total or the result of an expression requires more than 1024 bytes of Excel formula code, and an error message will be generated.
- Conditional styling is based on the values in the original report. If the worksheet values are changed and the formulas are recomputed, the styling will not reflect the

updated information.

Using EXL2K Formula With Prefix Operators

EXL2K FORMULA output supports prefix operators that are used on summary lines generated by FOCUS commands, such as SUBTOTAL and RECOMPUTE. Where a corresponding formula exists in Excel, these prefix operators are translated into the equivalent Excel summarization formula. The results of prefix operators used directly against retrieved data continue to be passed to Excel as values, not formulas.

The following table identifies the prefix operators supported by EXL2K FORMULA when used on summary lines, and the Excel formula equivalent placed in the generated worksheet.

Prefix Operator	Excel Formula Equivalent
SUM.	=SUM()
AVE.	=AVERAGE()
CNT.	=COUNT()
MIN.	=MIN()
MAX.	=MAX()

The following prefix operators are not translated to formulas when used on summary lines in EXL2K FORMULA.

- ASQ.
- FST.
- LST.

i Note:

- When using a prefix operator on a field specified directly against retrieved data, there is no space between the prefix operator and the field on which it operates.

For example, in the following aggregating display command, the AVE. prefix operator operates on the DEALER_COST field:

```
SUM AVE.DEALER_COST
```

- When using a prefix operator on a summary line, you must leave a space between the prefix operator and the aggregated field on which it operates.

In the following summary command, the MAX. prefix operator operates on the DOLLARS field at the REGION sort break. Note the required blank space between the prefix operator and the field name:

```
ON REGION RECOMPUTE MAX. DOLLARS
```

Using a Summary Prefix Operator With Format EXL2K FORMULA

In the following request against the GGSALES data source, the RECOMPUTE command for the REGION sort field calculates the maximum of the aggregated DOLLARS field and the minimum of the aggregated BUDDOLLARS field:

```
TABLE FILE GGSALES
SUM UNITS DOLLARS BUDDOLLARS
AND COMPUTE DIFF/I10= DOLLARS-BUDDOLLARS;
BY REGION
BY CATEGORY
WHERE CATEGORY EQ 'Food' OR 'Coffee'
WHERE REGION EQ 'West' OR 'Midwest'
ON REGION RECOMPUTE MAX. DOLLARS MIN. BUDDOLLARS DIFF
ON TABLE HOLD FORMAT EXL2K FORMULA
END
```

On the output, the cell that represents the recomputed DOLLARS for the Midwest region has been generated as the formula =MIN(E2:E3).

	A	B	C	D	E	F
1	Region	Category	Unit Sales	Dollar Sales	Budget Dollars	DIFF
2	Midwest	Coffee	332777	4178513	4086032	92481
3		Food	341414	4338271	4220721	117550
4	*TOTAL Midwest			4338271	4086032	252239
5	West	Coffee	356763	4473517	4523963	-50446
6		Food	340234	4202337	4183244	19093
7	*TOTAL West			4473517	4183244	290273
8	TOTAL			4473517	4086032	387485

Using PivotTables in EXL2K Report Output

The power of EXL2K format derives in large measure from its ability to take advantage of PivotTables. The PivotTable is a tool used in Microsoft Excel to analyze complex data. It allows you to drag data fields within a PivotTable, providing different views of the data, such as sorting across rows or columns. You can also create dimensional hierarchies, similar to those created using WITHIN syntax, by using the PAGEFIELDS command.

Report requests can be created in FOCUS and sent as output to a fully formatted Excel PivotTable. The ON TABLE HOLD FORMAT EXL2K PIVOT command will generate an Excel PivotTable in your browser.

	A	B	C	D	E	F	G	H	I	J	K
1	My PivotTable										
2	Sum of SALES										
3	COUNTRY	CAR	Total								
4	ENGLAND	JAGUAR	12000								
5		JENSEN	0								
6		TRIUMPH	0								
7	ENGLAND Total		12000								
8	FRANCE	PEUGEOT	0								
9	FRANCE Total		0								
10	ITALY	ALFA ROMEO	30200								
11		MASERATI	0								
12	ITALY Total		30200								
13	JAPAN	DATSUN	43000								
14		TOYOTA	35030								
15	JAPAN Total		78030								
16	W GERMANY	AUDI	7800								
17		BMW	80390								
18	W GERMANY Total		88190								
19	Grand Total		208420								

When FORMAT EXL2K PIVOT is enabled, two data streams are created:

- The first data stream is the PivotTable file.

The PivotTable file (.xht) is an HTML file with embedded XML. The HTML file contains all the information that is displayed in your browser.

- The second data stream is the PivotTable cache file (.xml).

The PivotTable cache file is a metadata type of file. It contains all the fields specified in the procedure and links internally to the PivotTable file. The PivotTable cache file can contain data fields called CACHEFIELDS, which populate the PivotTable toolbar, but do not initially display in the report. CACHEFIELDS can be dragged and dropped from the PivotTable toolbar into the PivotTable when required for analysis. The two data streams are packaged into one output file when the WEBARCHIVE parameter is set to ON. ON is the WEBARCHIVE parameter default value.

After creating FOCUS reports formatted as Excel PivotTables you must transfer both the XHT and XML files to Excel 2000 using FTP in ASCII mode or another transfer facility.

View the PivotTable Toolbar in Excel 2000/2003

The PivotTable toolbar may not automatically display when a PivotTable is created. To display the PivotTable toolbar, use the following procedure:

Procedure

1. Click **View** in the Excel toolbar.
2. Highlight Toolbars.
3. Click **PivotTable**.

Excel 2000/2003 displays the PivotTable toolbar, listing the fields available to be dragged into the body of the PivotTable report. A cell within the PivotTable must be selected for the Pivot toolbar to display all fields.

How TABLE Elements Appear in a Pivot Table

The PivotTable is generated by the PRINT command in combination with the BY, ACROSS, PAGEFIELDS and CACHEFIELDS phrases. It contains all options used to design and format the report, as well as fields specified in the PIVOT request. Fields can be dragged into the

report from the toolbar. The following graphic depicts PivotTable output with the major elements identified.

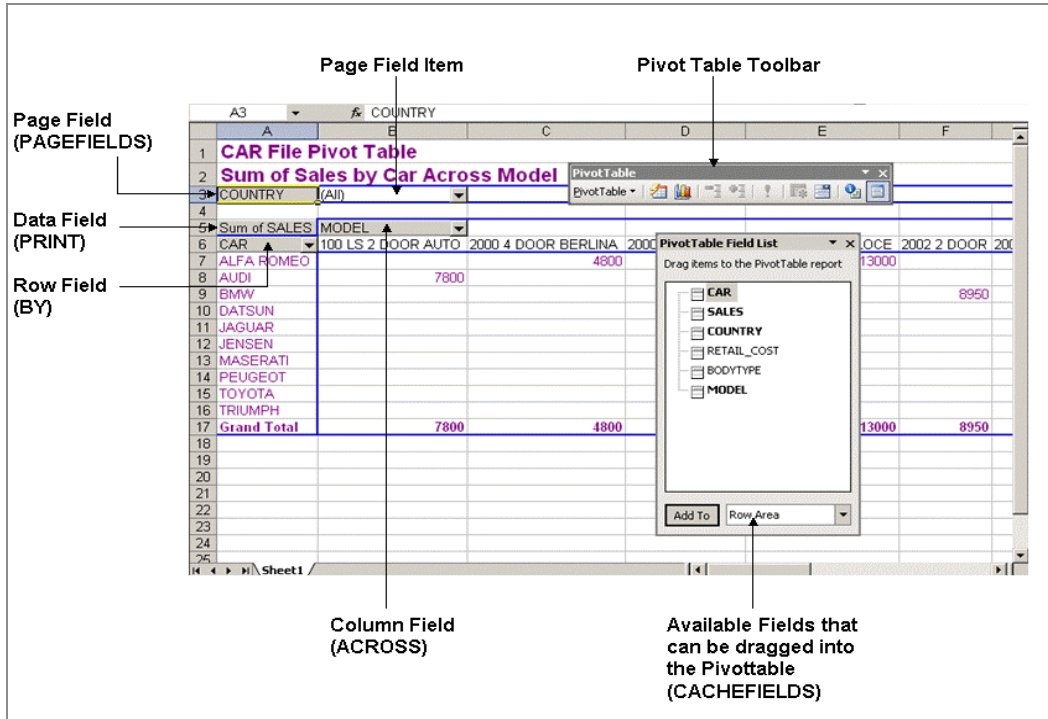

The following summary table shows PivotTable elements and the associated FOCUS syntax.

PivotTable Element	Contains...	Function	Generating Syntax
Page field	Field that controls view of the entire page (worksheet).	A filtering mechanism to conduct a high level sort.	PAGEFIELDS phrase
Page field item	The value for a page field item displays in a drop-down list.	Selecting a page field item summarizes data for the entire report.	PAGEFIELDS phrase
Data field	Numeric data that is available to be	Holds data available to be	PRINT command

PivotTable Element	Contains...	Function	Generating Syntax
	summarized.	summarized.	
Column field	Horizontal sort data.	Sorts data horizontally.	ACROSS command
Row field	Vertical sort data.	Sorts data vertically.	BY command

Effect of TABLE Syntax Elements on PivotTables

The following table summarizes TABLE syntax elements that are supported in EXL2K PIVOT. The effect of each command on your PivotTable request is listed, along with required usage.

Syntax Element	Usage	Effect on PivotTable
PRINT	Required.	Designates the data field in a PivotTable.
BY	Optional. *	Designates row field in a PivotTable.
ACROSS	Optional. *	Designates a column field in a PivotTable.
CACHEFIELDS	Optional. *	Places fields in the Pivot cache file and makes them available from the Pivot toolbar.
PAGEFIELDS	Optional. *	Designates a Page field in a PivotTable.

* You need at least one sort field or a PAGEFIELD for a valid Pivot Table.

Enabling PivotTables

The standard HOLD and SAVE syntax for storing the output file on disk is supported for the EXL2K PIVOT file format. When FORMAT EXL2K PIVOT is enabled, two files are created, the PivotTable file (.xht) and a PivotTable cache file (.xml). The PivotTable cache file contains all the fields specified in the procedure and links internally to the PivotTable file. All available fields can be viewed in the PivotTable toolbar.

You can include the CACHEFIELDS phrase in a request to add fields to the pivot cache that are not initially displayed in the report. The cache file enables you to add available fields from the PivotTable toolbar into the body of the PivotTable by dragging and dropping. You can remove fields from the PivotTable by dragging and dropping them anywhere outside the report. Using these tools, you can quickly vary data views.

Enable the PivotTable

The following are syntax variations that you can use to enable FORMAT EXL2K PIVOT.

```
ON TABLE HOLD FORMAT EXL2K PIVOT AS mypivot
```

where:

mypivot

Is a name you assign to the HOLD file.

Two files are generated with this syntax:

- MYPIVOT.XHT is the main file that is displayed in the browser or Excel window.
- MYPIVO\$.XML is the Pivot Cache file.

Usage Notes for PivotTable Requests

You should consider the following when writing requests for output to a PivotTable:

- Requests must use the display command PRINT. This is necessary to extract all data (each individual record) into the pivot cache file. The field that follows the PRINT

command is designated as the PivotTable data field and must be numeric.

Note that the SUM and COUNT commands are *not* supported for EXL2K PIVOT. Nevertheless, you can use this native Pivot Table behavior in Excel after the data has been output to an Excel PivotTable.

- A field that is used in a PivotTable cannot be listed more than once in the report request. Each field can function in only one role in a FORMAT EXL2K PIVOT request. For example, a Page field cannot display simultaneously as a column and a row field.
- Styling is based on the initial state of your report and retained only on a limited basis when you pivot the output.
- NODATA fields will display as blank cells in the PivotTable.
- Text fields and Timestamp fields may not be used in Excel PivotTables. In addition, ensure that there is no missing data for any fields.
- You can include column, row, grand totals, and subtotals in a PivotTable. If no totals are specified in a request, no totals will display in Excel 2000/2003.
- Borders are not supported for Excel Pivot Tables.

Using the EXL2K PIVOT Option

This simple example shows how to populate and generate PivotTables:

```
TABLE FILE CENTINV
HEADING
"CENTINV File PivotTable"
"Sum of Price by Product Across Category"
PRINT PRICE
BY PROD_NUM
ACROSS PRODCAT
ON TABLE COLUMN-TOTAL
  ON TABLE HOLD AS EXL2K9 FORMAT EXL2K PIVOT
  PAGEFIELDS PRODNAME
  CACHEFIELDS COST QTY_IN_STOCK
ON TABLE SET STYLE *
TYPE=HEADING, LINE=1, FONT='ARIAL', COLOR=PURPLE, SIZE=16, STYLE=BOLD,$
TYPE=HEADING, LINE=2, FONT='ARIAL', COLOR=PURPLE, SIZE=12, STYLE=BOLD,$
TYPE=DATA, FONT='ARIAL', COLOR=PURPLE,$
TYPE=GRANDTOTAL, FONT='ARIAL', COLOR=PURPLE, SIZE=12, STYLE=BOLD,$
```



```
ENDSTYLE
END
```

The output is:

Product Number	Camcorders	Cameras	CD Players	Digital Ta	ices	VCRs
1004						179.00
1006						
1008						
1010	999.00					
1012	899.00					
1014		249.00				
1016		279.00				
1018	399.00					
1020	319.00					
1022	399.00					
1024	349.00					
1026		129.00				
1028		109.00				
1030			169.00			
1032						
1034						
1036						
Grand Total	3,364.00	766.00	169.00	89.00	598.00	179.00

Designating CACHEFIELDS in PivotTables

You can specify multiple fields as CACHEFIELDS. These fields will not initially display in the report, but will be available in the pivot cache file if you wish to include them in the report at a later time.

You can then drag these fields in and out of the PivotTable as desired. CACHEFIELDS is an optional phrase; you can generate a PivotTable without a CACHEFIELD.

Usage Notes for Specifying CACHEFIELDS

Fields designated as CACHEFIELDS must be placed immediately after the PIVOT keyword in the ON TABLE HOLD FORMAT EXL2K PIVOT syntax or after a PAGEFIELDS phrase. A field specified as a CACHEFIELD cannot be designated anywhere else in the request. A list of CACHEFIELDS is terminated by the same keywords that terminate a normal report request,

such as END or another ON phrase.

Using CACHEFIELDS With EXL2K PIVOT

This example shows how to specify CACHEFIELDS to populate the PivotTable toolbar.

```
TABLE FILE CENTINV
HEADING
"PivotTable with CACHEFIELDS"
"Sum of Price by Product Across Category"
PRINT PRICE
BY PRODCAT BY PRODTYPE
ON PRODCAT SUB-TOTAL
  ON TABLE HOLD AS EXL2K10 FORMAT EXL2K PIVOT
  CACHEFIELDS COST PRODNAME
ON TABLE SET STYLE *
TYPE=DATA, COLUMN=PRODCAT, COLOR=RED,$
TYPE=HEADING, COLOR=BLUE, STYLE=BOLD, SIZE=14,$
ENDSTYLE
END
```

The output is:

The screenshot displays an IBM i report window with a PivotTable and its field list. The PivotTable is titled "Sum of Price:" and shows the sum of prices by product category and type. The field list shows the fields used in the report: Product Category, Product Type, Price, Our Cost, and Product Name.

Product Category:	Product Type:	Total
Camcorders	Analog	1,466.00
	Digital	1,898.00
Camcorders Total		3,364.00
Cameras	Analog	238.00
	Digital	528.00
Cameras Total		766.00
CD Players	Digital	169.00
CD Players Total		169.00
Digital Tape Recorders	Digital	89.00
Digital Tape Recorders Total		89.00
DVD	Digital	598.00
DVD Total		598.00
PDA Devices	Digital	798.00
PDA Devices Total		798.00
VCRs	Analog	179.00
VCRs Total		179.00
Grand Total		5,963.00

The PivotTable Field List shows the following fields:

- Product Category:
- Product Type:
- Price:
- Our Cost:
- Product Name:

The "Add To" button is set to "Row Area".

Designating PAGEFIELDS in PivotTables

You can specify a field in the procedure as an Excel 2000/2003 page field. The page field filters the data for the specified field. Then, using PivotTable functionality, you can choose a single value from the page field drop-down menu (also called a page field item) and immediately see only the data associated with that selection. For example, in a report that shows international sales data for cars, if you specify COUNTRY as your page field and select JAPAN as your page field item, you will see only sales data for TOYOTA or NISSAN. If you then select ENGLAND, you will see the data for JAGUAR and TRIUMPH.

A page field can act as the sort field. A valid PivotTable can be generated without specifying a PAGEFIELD if sorting is handled by either a BY or ACROSS phrase. However, if the PivotTable request contains neither a BY or ACROSS phrase, a PAGEFIELD phrase must be included.



Note:

- A field specified as a PAGEFIELD cannot be designated anywhere else in the request.
- Because Excel is case-insensitive, the values of the PAGEFIELD must not contain duplicate values in different cases. For example, "JONES" and "jones" are considered equal in Excel. Use the UPCASE and LOCASE functions to convert mixed case values.

Using FORMAT EXL2K PIVOT With PAGEFIELDS

This example illustrates the use of PAGEFIELDS syntax to make three fields available in the PivotTable toolbar.

```
TABLE FILE CENTINV
HEADING
"PivotTable with PAGEFIELDS"
PRINT PRICE COST
  ON TABLE HOLD AS EXL2K11 FORMAT EXL2K PIVOT
  PAGEFIELDS PRODCAT PRODNAME PRODTYPE
ON TABLE SET STYLE *
TYPE=DATA, COLUMN=PRODCAT, COLOR=RED,$
TYPE=HEADING, COLOR=BLUE, STYLE=BOLD, SIZE=14,$
```

```
ENDSTYLE
END
```

This output is:

The screenshot shows an Excel spreadsheet with a PivotTable and its field list. The PivotTable is located in cells A2:B8 and is titled "PivotTable with PAGEFIELDS". The field list is open, showing the following fields: Price, Our Cost, Product Category, Product Name, and Product Type. The PivotTable data is as follows:

	Total
Sum of Price:	5,963.00
Sum of Our Cost:	4,423.00

Creating EXL2K Reports Using an Excel Template

Excel templates enable users to create WebFOCUS reports with any new or existing Excel workbook residing on the WebFOCUS Reporting Server. WebFOCUS can integrate with complex Excel workbooks containing macros, graphs, or Visual Basic applications with the use of Excel templates. Users also have access to more advanced Excel functionality including filters, subtotals, page and print settings, and advanced report styling.

To create an Excel template, open a new or existing Excel workbook and designate one worksheet to be replaced with a WebFOCUS report. The worksheet being replaced must be visible (not hidden). Each worksheet in the workbook must not be empty (populated with at least one blank in one cell). A workbook utilizing Excel templates must be saved as a Single File Web Page (Web Archive) with an extension of .mht and stored in the WebFOCUS Reporting Server application Path (APP PATH).

After saving, if you do not see the .mht file extension for the Excel/2000/2003 template file you created, uncheck the **Hide extensions for known file types** option in Windows Folder Options View tab dialog:

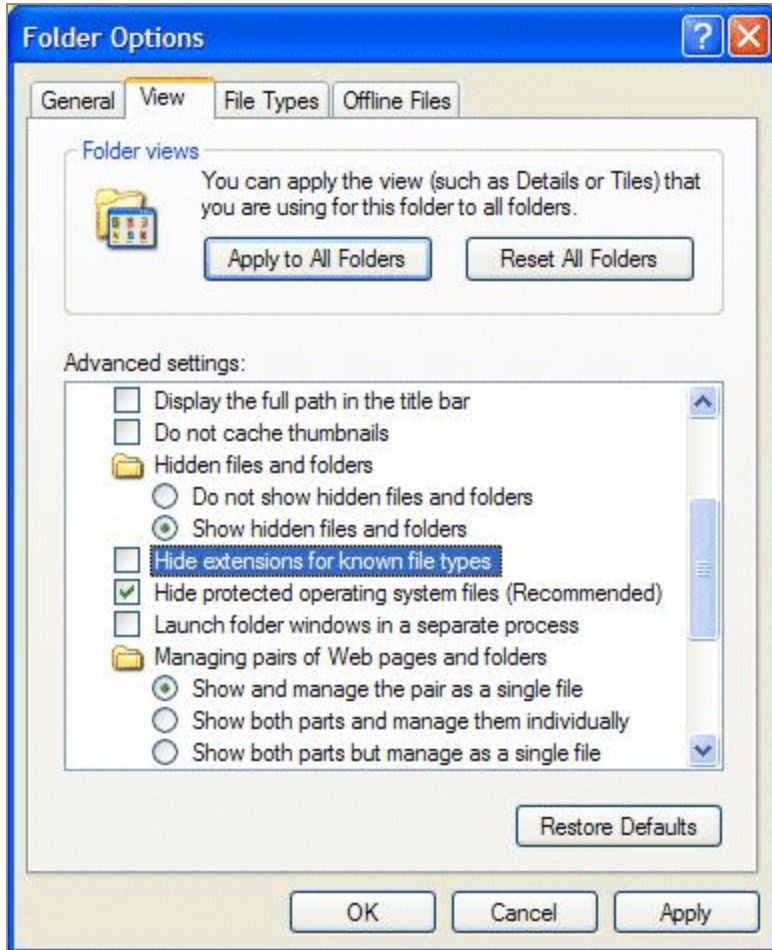

Support for Excel Templates With EXL2K Display Formats

EXL2K and EXL2K FORMULA are the only formats supported and Excel templates will only work with Excel 2002 and higher versions.

The following are not supported with Excel templates: EXL2K PIVOT, EXL2K BYTOC reports, EXL97, EXCEL, and compound Excel reports.

With EXL2K TEMPLATE format, WEBARCHIVE is automatically on.

The PCHOLD command returns an .xmh file, which the mid-tier converts to an .mht. HOLD creates an .xht file.

Create a Report Using an Excel Template

To create a report using an Excel template, specify the following:

```
ON TABLE PCHOLD FORMAT EXL2K TEMPLATE template_name SHEETNUMBER #
```

where:

template_name

The name of the Excel template file (workbook) residing on the WebFOCUS Reporting Server.

#

The number of the Excel worksheet being replaced in the template file (workbook).

Utilizing Excel Named Ranges

An Excel Named Range is a name assigned to a specific group of cells within an Excel worksheet that can be easily referenced by FOCUS applications. FOCUS StyleSheet language facilitates the generation of Named Ranges.

The use of Excel Named Ranges provides many benefits, including the following:

- Provides advantages over static cell references, including the ability of named range data areas to expand to include new data added during scheduled workbook updates.
- Enables easy setup of Excel worksheets, created by FOCUS applications, as an ODBC (Open Database Connectivity) data source.
- Provides accurate, consistent data feeds to advanced Excel worksheet applications, which eliminates manual activities that tend to result in errors.
- Simplifies the process of referencing data in multiple worksheets. This is especially useful when named ranges are added to the output of an Excel Template report.

Use Excel Named Ranges

To create Excel Named Ranges, use

```
TYPE=type, IN-RANGES=rangename, $
```

where:

type

Identifies the FOCUS report component to be included in the range. Normally, both of the following are used together:

DATA adds the DATA element of the report to the named range (excludes heading, footing, and column titles).

TITLE adds the TITLE element of the report to the named range (includes all column titles).

i **Note:** Multiple elements can be added to the same named range.

rangename

Is the name assigned to the output in the Excel workbook your application is creating, and is also the name that will be referenced by other FOCUS applications.

Using Excel Named Ranges

This example creates one report in one worksheet of an Excel workbook. The code specific to Excel Named Ranges appears in bold in the following syntax.

```
TABLE FILE GGSales
PRINT
    PRODUCT
    DATE
    UNITS
BY REGION
BY DOLLARS
ON TABLE SET PAGE-NUM OFF
ON TABLE SET BYDISPLAY ON
```

```

ON TABLE NOTOTAL
ON TABLE HOLD FORMAT EXL2K
ON TABLE SET STYLE *
    UNITS=IN, SQUEEZE=ON, ORIENTATION=PORTRAIT, $
TYPE=REPORT, FONT='ARIAL', SIZE=9, COLOR='BLACK', BACKCOLOR='NONE',
STYLE=NORMAL, $
TYPE=DATA, IN-RANGES='RegionalSales', $
TYPE=TITLE, STYLE=BOLD, IN-RANGES='RegionalSales',
$
ENDSTYLE
END

```

The Excel output is:

1	Region	Dollar Sales	Product	Date	Unit Sales
2	Midwest	748	Thermos	1996/08/01	68
3	Midwest	944	Mug	1997/08/01	86
4	Midwest	980	Thermos	1996/07/01	89
5	Midwest	1010	Scone	1996/09/01	101
6	Midwest	1060	Thermos	1996/02/01	96
7	Midwest	1069	Mug	1996/11/01	89
8	Midwest	1100	Croissant	1996/11/01	100
9	Midwest	1111	Espresso	1997/08/01	101
10	Midwest	1111	Latte	1996/11/01	101
11	Midwest	1230	Espresso	1996/07/01	123
12	Midwest	1247	Coffee Grinder	1996/06/01	125
13	Midwest	1294	Mug	1996/12/01	92
14	Midwest	1309	Espresso	1997/03/01	119
15	Midwest	1327	Mug	1996/06/01	133
16	Midwest	1336	Mug	1996/01/01	121
17	Midwest	1340	Espresso	1996/07/01	134
18	Midwest	1364	Coffee Pot	1997/02/01	105
19	Midwest	1364	Thermos	1997/10/01	105
20	Midwest	1368	Croissant	1997/10/01	114
21	Midwest	1378	Coffee Pot	1997/10/01	115
22	Midwest	1380	Scone	1996/01/01	115
23	Midwest	1392	Latte	1997/10/01	116
24	Midwest	1407	Mug	1997/01/01	108

The name assigned to this Excel Named Range is RegionalSales. If additional rows of data are added, or columns of data are inserted, the named range will stretch to contain both new and existing data.

Rules for Excel Named Ranges

- The Excel data area associated with a named range must be continuous and cannot contain any breaks in the data. Examples of report components containing breaks in the data that cannot be part of a named range include SUBHEAD and SUBFOOT.

- It is recommended that you use ON TABLE SET BYDISPLAY ON. This activates the option to display repeated sort values, which produces continuous output with no breaks in the data.
- Two different worksheets from the same workbook cannot have the same range name.
- When creating Compound Excel reports (multiple TABLE requests output to the same Excel workbook), each report must have a unique range name that is stored at the workbook level.

Support for Excel Named Ranges

Excel Named Ranges are supported for the following Excel formats:

EXL2K, EXL2K FORMULA, EXL2K TEMPLATE

Excel Named Ranges are not supported for the following Excel formats:

EXL2K BYTOC, EXCEL PIVOT

Excel Named Ranges are not supported with any report syntax that produces discontinuous data or uses columnar references that span multiple columns, which includes the following:

ACROSSCOLUMN, RECAP, RECOMPUTE, SUBHEAD, SUBFOOT, SUBTOTAL, SUB-TOTAL

Creating Excel Table of Contents Reports

Excel Table of Contents (TOC) enables you to generate a multiple worksheet report in which a separate worksheet is generated for each value of the first BY field in the FOCUS report.

i Note: This feature can be used only with Excel 2002 or higher releases because it requires the Web Archive file format, which was not available in Excel 2000 and earlier releases.

Use the Excel Table of Contents Feature

```
ON TABLE HOLD FORMAT EXL2K BYTOC
```

SET COMPOUND syntax, which precedes the TABLE command, may also be used to specify that a TOC be created:

```
SET COMPOUND=BYTOC
```

Since a TOC report is burst into worksheets according to the value of the first BY field in the report, the report must contain at least one BY field. The bursting field may be a NOPRINT field.

Limitations of TOC Reports

- A TOC report cannot be embedded in a compound report.
- A TOC report cannot be a pivot table report.
- A TOC report cannot be generated against a multi-verb request.

Creating a Simple TOC Report

The following request against the GGSALES data source creates separate tabs based on the REGION sort field:

```
TABLE FILE GGSALES  
SUM UNITS/D12C DOLLARS/D12CM  
BY REGION NOPRINT  
BY CATEGORY  
BY PRODUCT  
HEADING  
"<REGION Region Sales"  
ON TABLE HOLD FORMAT XLSX  
ON TABLE SET BYDISPLAY ON  
ON TABLE SET COMPOUND BYTOC  
ON TABLE SET STYLE *
```

```

TYPE=REPORT, FONT=ARIAL, SIZE=9, $
TYPE=HEADING, SIZE=12, $
TYPE=TITLE, BACKCOLOR=GREY, COLOR=WHITE, $
ENDSTYLE
END

```

The output is:

	A	B	C	D
1	Midwest Region Sales			
2	Category	Product	Unit Sales	Dollar Sales
3	Coffee	Espresso	101,154	\$1,294,947
4	Coffee	Latte	231,623	\$2,883,566
5	Food	Biscotti	86,105	\$1,091,727
6	Food	Croissant	139,182	\$1,751,124
7	Food	Scone	116,127	\$1,495,420
8	Gifts	Coffee Grinder	50,393	\$619,154
9	Gifts	Coffee Pot	47,156	\$599,878
10	Gifts	Mug	86,718	\$1,086,943
11	Gifts	Thermos	46,587	\$577,906
12				

How to Name Worksheets

- The worksheet tab names are the BY field values that correspond to the data on the current worksheet. If the user specifies the TITLETEXT keyword in the stylesheet, it will be ignored.
- Excel limits the length of worksheet titles to 31 characters. The following special characters cannot be used: ':', '?', '*', and '/'.
- If you want to use date fields as the bursting BY field, you can include the - character instead of the / character. The - character is valid in an Excel tab title. However, if you do use the / character, FOCUS will substitute it with the - character.

Naming EXL2K Worksheets with Case Sensitive Data

The BYTOC option of FOCUS EXL2K format generates a workbook containing an individual worksheet for each primary sort (BY) field in the report. Each sheet is named with the value of the primary sort field to identify the data it contains.

Excel requires each sheet name to be unique. Excel is case insensitive meaning it evaluates two values as being the same when the values contain the same characters but have different casing. For example, Excel evaluates the values COFFEE and Coffee to be the same value and, therefore, they cannot be used as sheet names for two different sheets.

By default, FOCUS sort processing is case sensitive, so the same field value with different casing is considered to be two different values when used as a sort (BY) field. In an Excel BYTOC report, FOCUS will generate sheets with sheet names for each value of the primary sort (BY) key based on case sensitivity. For sort values that differ in casing only, the initial sheet will receive the sort value, and Excel will have difficulty with any subsequent sheet generated with the same name. The second sheet name will display as **Recovered_Sheet1** in place of the value Excel considers a duplicate.

Using Case Sensitive Data in an EXL2K TOC Report

In the following example, FOCUS will generate separate worksheets for the values Coffee and COFFEE. The initial worksheet will be named COFFEE, but for the subsequent worksheet representing the value **Coffee**, Excel will be unable to use the value as the worksheet name and will display the recovered value.

```
DEFINE FILE GGSales
SHOWCAT/A15=IF PRODUCT EQ 'Espresso' THEN 'COFFEE' ELSE CATEGORY;
END
TABLE FILE GGSales
BY SHOWCAT
BY PRODUCT
ON TABLE SET PAGE-NUM OFF
ON TABLE HOLD FORMAT EXL2K
ON TABLE SET COMPOUND 'BYTOC 1'
END
```

On the output, the second tab has the name **Recovered_Sheet1** instead of the case sensitive value **Coffee**:

	A	B	C	D	E	F
1	SHOWCAT	Product				
2	COFFEE	Espresso				
3						
4						
5						
6						
7						

Using Case Sensitive Data as Worksheet Names

When you know your data contains values with case sensitive differences in the highest level sort field, you will need to massage your data values so that they can be used as valid sheet names in the BYTOC workbook.

Different approaches include:

- Converting your values to a single case so that they group together in FOCUS as they do in Excel. You can control the collation sequence with the SET COLLATION=SRV_CI command described in [Controlling Collation Sequence](#).
- Adding a unique sequence number to your high level sort field values so that they continue to create different tabs but the sheet name values remain unique

Creating Unique Case Sensitive Sheet Names

In the following example, the sheet name is built by adding a unique counter to each unique value of the high level sort field. The new computed field is then used as the first BY field in the request, so it is used by the BYTOC phrase to define the sheet names. The sheet name field can be presented within the report or specified as a NOPRINT field so that it displays on the tab but does not display on the actual report:

```
DEFINE FILE GGSales
SHOWCAT/A15=IF PRODUCT EQ 'Espresso' THEN 'COFFEE' ELSE CATEGORY;
END
TABLE FILE GGSales
```

```

PRINT SHOWCAT NOPRINT
COMPUTE CNTR/I2 = IF SHOWCAT EQ LAST SHOWCAT THEN LAST CNTR ELSE CNTR +
1; NOPRINT
BY TOTAL COMPUTE SHOWCAT2/A20 = EDIT(CNTR) | '-' | SHOWCAT; NOPRINT
BY SHOWCAT
BY PRODUCT
ON TABLE SET PAGE-NUM OFF
ON TABLE HOLD FORMAT EXL2K
ON TABLE SET COMPOUND BYTOC
ON TABLE SET STYLE *
GRID=OFF, $
ENDSTYLE
END

```

On the output, each tab has a name consisting of a sequence number followed by the sort field value with its correct case.

	A	B	C	D	E	F
1	SHOWCAT	Product				
2	COFFEE	Espresso				
3						
4						
5						
6						
7						

Worksheet tabs: 01-COFFEE, 02-Coffee, 03-Food, 04-Gifts

Overcoming the Excel 2003 65K Row Limit Using Overflow Worksheets

The maximum number of rows supported by Excel 2003 on a worksheet is 65,536 (65K). When you create an EXL2K output file from a FOCUS report, the number of rows generated can be greater than this maximum.

To avoid creating an incomplete output file, you can have extra rows flow onto a new worksheet, called an overflow worksheet. The name of each overflow worksheet will be the name of the original worksheet appended with an increment number.

In addition, when the overflow worksheet feature is enabled, you can set a target value for the maximum number of rows to be included on a worksheet. By default, the row limit will be set to the default value for the LINES parameter (57).

i Note: When generating EXL2K output, the FOCUS page heading and page footing commands generate worksheet headings and worksheet footings.

Enable Overflow Worksheets

Add the ROWOVERFLOW attribute to your FOCUS StyleSheet

```
TYPE=REPORT, ROWOVERFLOW={ON|OFF|PBON}, [ROWLIMIT={n|MAX}]...
```

where:

ON

Enables overflow worksheets.

OFF

Disables overflow worksheets. OFF is the default value.

PBON

Inserts FOCUS page breaks that display the page heading, footing, and column titles at the appropriate places within the worksheet rows. This option does not cause a new worksheet to start when a FOCUS page break occurs.

ROWLIMIT=n

Sets a target value for the number of rows to be included on a worksheet to **n** rows. The default value is the LINES value (by default, 57).

ROWLIMIT=MAX

Sets a target value for the number of rows to be included on a worksheet to 65,000 rows for EXL2K output.

This attribute will work only with EXL2K or XLSX output. For all other output types, the ROWOVERFLOW StyleSheet attribute is ignored, and data flow is not affected.

Usage Notes for Excel 2003 Overflow Worksheets

- The report heading is placed once at the start of the first sheet. The report footing is placed once at the bottom of the last overflow sheet.
- Unless the PBON setting is used, worksheet headings and column titles are repeated at the top of the original sheet and each subsequent overflow sheet. Worksheet footings are placed at the bottom of the original sheet and each subsequent overflow sheet. The data values are displayed on the top data row of each overflow sheet, as they would be on a standard new page.
- Report total lines are displayed at the bottom of the last overflow sheet directly above the final page and table footings.
- Subheadings, subfootings, and subtotal lines display within the data flow as normal. No special consideration is made to retain groupings within a given sheet.
- If ROWOVERFLOW=PBON, the page headings and footings and column titles display within the worksheet when a FOCUS command causes a page break.
- For EXL2K output, if the ROWOVERFLOW attribute is specified in the StyleSheet and SET LINES is greater than 65K, the following message is presented and no output file is generated:

```
(FOC3313) The line number limit per EXCEL 2003 worksheet is 65536.
```

- Output types that contain formula references (EXL2K PIVOT and EXL2K FORMULA) are not supported. Formula references are not automatically updated to reflect placement on new overflow worksheets.
- The overflow worksheet feature applies to rows only, not columns. A new worksheet will not automatically be created if a report generates more than the Excel 2003 limit of 256 columns.
- ROWOVERFLOW is supported for compound layout and BYTOC reports.
- As named ranges in Excel cannot run across multiple worksheets, the IN-RANGES phrase that defines named ranges in the resulting workbook is not supported with the ROWOVERFLOW feature. When they exist together in the same request, ROWOVERFLOW takes precedence and the IN-RANGES phrase is ignored.

Creating Overflow Worksheets With EXL2K Report Output

The following request creates EXL2K report output with overflow worksheets. The SET LINES command sets the maximum number of rows in each worksheet to approximately 2000, and the ROWOVERFLOW=ON attribute in the StyleSheet activates the overflow feature. Without this attribute, one worksheet would have been generated instead of three:

```
TABLE FILE GGSales
- * ****Report Heading****
ON TABLE SUBHEAD
"SALES BY REGION, CATEGORY, AND PRODUCT"
" "
- * ****Worksheet Heading****
HEADING
"SALES REPORT WORKSHEET <TABPAGE NO>"
" "
- * ****Worksheet Footing****
FOOTING
" "
"END OF WORKSHEET <TABPAGE NO>"
```

```
PRINT DOLLARS UNITS BUDDOLLARS BUDUNITS
BY REGION
BY CATEGORY
BY PRODUCT
BY DATE
- * ****Subfoot****
ON REGION SUBFOOT
" "
" End of Region <REGION>"
" "
- * ****Subhead****
ON CATEGORY SUBHEAD
" "
" Category <CATEGORY> for Region <REGION>"
" "
- * ****Report Footing****
ON TABLE SUBFOOT
" "
"END OF REPORT"
```

```

ON TABLE SET LINES 2000
ON TABLE HOLD FORMAT EXL2K
ON TABLE SET STYLE *
TYPE=REPORT, TITLETEXT=EXLOVER, ROWOVERFLOW=ON,$
ENDSTYLE
END

```

The report heading displays on the first worksheet only, the page heading and column titles display on each worksheet, and the subhead and subfoot display whenever the associated sort field changes value. The following image shows the top of the first worksheet, displaying the report heading, page heading, column titles, and first subhead:

Region	Category	Product	Date	Dollar Sales	Unit Sales	Budget Dollars	Budget Units
Category Coffee for Region Midwest							
Midwest	Coffee	Espresso	1996/01/01	19752	1646	24141	1857
				13416	1118	16068	1236
				13170	878	10000	1000
				10164	924	12552	1046
				6048	432	6565	505
				4693	361	8310	554
			1996/02/01	16968	1212	13622	973
				13420	1220	20415	1361
				13095	873	6910	691
				8340	834	8460	705
				6454	461	8540	610
				4355	335	5400	360
			1996/03/01	18466	1319	15120	1512
				18135	1395	17069	1313
				12690	846	7060	706
				11450	1145	14490	1035
				10802	982	9555	735
				10023	771	8180	765

Note that the TITLETEXT attribute in the StyleSheet specified the name EXLOVER, so the three worksheets were generated with the names EXLOVER1, EXLOVER2, and EXLOVER3. If there had been no TITLETEXT attribute, the sheets would have been named SHEET1, SHEET2, and SHEET3.

The worksheet footing displays at the bottom of each worksheet and the report footing displays at the bottom of the last worksheet. The following image shows the bottom of the last worksheet, displaying the last subfoot, the page footing and the report footing:

SALES REPORT WORKSHEET 3										
A	B	C	D	E	F	G	H	I	J	
363				9194	657	7722	772			
364				8981	816	7983	665			
365			1997/08/01	14276	1020	17087	1139			
366				8679	868	7366	737			
367				2179	168	1911	127			
368			1997/09/01	4380	365	5869	451			
369				2152	215	3732	287			
370				1459	112	0	0			
371			1997/10/01	9798	754	8070	673			
372				6402	640	9880	659			
373				6302	450	6570	597			
374			1997/11/01	8448	845	7855	714			
375				6154	440	4966	451			
376				4552	414	4844	484			
377			1997/12/01	15092	1161	16549	1182			
378				11197	746	13464	898			
379				10346	690	10536	810			
380										
381	End of Region West									
382										
383										
384	END OF WORKSHEET 3									
385										
386	END OF REPORT									

Creating Overflow Worksheets With FOCUS Page Breaks

The following request creates EXL2K report output with overflow worksheets. The ROWOVERFLOW=PBON attribute in the StyleSheet activates the overflow feature, and the ROWLIMIT=250 sets the maximum number of rows in each worksheet to approximately 250. Without this attribute, one worksheet would have been generated. The PRODUCT sort phrase specifies a page break.

```
TABLE FILE GGSales
  -* ****Report Heading****
  ON TABLE SUBHEAD
  "SALES BY REGION, CATEGORY, AND PRODUCT"
  " "
  PRINT DOLLARS UNITS BUDDOLLARS BUDUNITS
  BY REGION
  BY HIGHEST CATEGORY
  BY PRODUCT PAGE-BREAK
  BY DATE
  WHERE DATE GE '19971001'
  -* ****Page Heading****
  HEADING
  " Product: <PRODUCT in Category: <CATEGORY for Region: <REGION"
  -* ****Page Footing****
```

```
FOOTING
" "
-* ****Report Footing****
ON TABLE SUBFOOT
" "
"END OF REPORT"
ON TABLE SET BYDISPLAY ON
ON TABLE HOLD FORMAT EXL2K
ON TABLE SET STYLE *
INCLUDE=endflt,TITLETEXT=EXLOVER, ROWOVERFLOW=PBON, ROWLIMIT=250,
$
ENDSTYLE
END
```

The report heading displays on the first worksheet only, the page heading, footing, and column titles display on each worksheet and at each FOCUS page break (each time the product changes), and the subhead and subfoot display whenever the associated sort field changes value. The following image shows the top of the first worksheet.

SALES BY REGION, CATEGORY, AND PRODUCT

Product: Coffee Grinder in Category: Gifts for Region: Midwest

Region	Category	Product	Date	Dollar Sales	Unit Sales	Budget Dollars	Budget Units
Midwest	Gifts	Coffee Grinder	1997/10/01	14494	95.6	1175.4	1059
Midwest	Gifts	Coffee Grinder	1997/10/01	3453	49.6	601.9	502
Midwest	Gifts	Coffee Grinder	1997/10/01	1750	13.9	217.3	149
Midwest	Gifts	Coffee Grinder	1997/11/01	12333	114.0	1009.7	1191
Midwest	Gifts	Coffee Grinder	1997/11/01	12190	110.8	1457.1	1041
Midwest	Gifts	Coffee Grinder	1997/11/01	9352	59.6	1016.1	347
Midwest	Gifts	Coffee Grinder	1997/12/01	47455	350.9	4503.6	3737
Midwest	Gifts	Coffee Grinder	1997/12/01	7356	49.0	650.1	630
Midwest	Gifts	Coffee Grinder	1997/12/01	4073	37.0	513.3	313
Midwest	Gifts	Coffee Grinder	1997/12/01	1967	17.9	354.0	235

Product: Coffee Pot in Category: Gifts for Region: Midwest

Region	Category	Product	Date	Dollar Sales	Unit Sales	Budget Dollars	Budget Units
Midwest	Gifts	Coffee Pot	1997/10/01	12333	107.0	1533.3	1032
Midwest	Gifts	Coffee Pot	1997/10/01	11609	116.1	1542.3	1216
Midwest	Gifts	Coffee Pot	1997/10/01	1378	11.3	112.4	36
Midwest	Gifts	Coffee Pot	1997/11/01	3348	59.6	1099.1	345
Midwest	Gifts	Coffee Pot	1997/11/01	3131	31.3	910.1	630
Midwest	Gifts	Coffee Pot	1997/11/01	3722	24.3	233.4	199
Midwest	Gifts	Coffee Pot	1997/12/01	10393	70.6	830.6	334
Midwest	Gifts	Coffee Pot	1997/12/01	9237	61.7	963.3	344
Midwest	Gifts	Coffee Pot	1997/12/01	3300	44.6	423.1	332

Product: Mug in Category: Gifts for Region: Midwest

Region	Category	Product	Date	Dollar Sales	Unit Sales	Budget Dollars	Budget Units
Midwest	Gifts	Mug	1997/10/01	14492	111.3	1355.2	1044
Midwest	Gifts	Mug	1997/10/01	14333	95.6	1264.2	347
Midwest	Gifts	Mug	1997/10/01	11270	112.7	1173.1	1170
Midwest	Gifts	Mug	1997/10/01	10746	76.3	1102.9	733
Midwest	Gifts	Mug	1997/10/01	7319	73.2	934.1	702
Midwest	Gifts	Mug	1997/10/01	4933	33.3	553.3	393
Midwest	Gifts	Mug	1997/11/01	11450	33.3	973.3	749
Midwest	Gifts	Mug	1997/11/01	9393	72.3	777.3	707
Midwest	Gifts	Mug	1997/11/01	3331	33.3	1107.3	739
Midwest	Gifts	Mug	1997/11/01	4917	49.2	393.3	493
Midwest	Gifts	Mug	1997/11/01	1950	13.1	333.1	333
Midwest	Gifts	Mug	1997/11/01	1956	13.0	393.1	330
Midwest	Gifts	Mug	1997/12/01	13333	109.0	1333.3	1039
Midwest	Gifts	Mug	1997/12/01	14913	114.7	1453.0	1213
Midwest	Gifts	Mug	1997/12/01	14333	112.7	1790.9	1194
Midwest	Gifts	Mug	1997/12/01	14337	110.3	1333.3	1133

Providing a Tooltip on a Drilldown Hyperlink for EXL2K Reports

You can use the ALT attribute in a StyleSheet for EXL2K report output to provide informational text (a tooltip) for a drilldown hyperlink.

Provide a ToolTip for a Drilldown Hyperlink

For a drilldown hyperlink to a FOCEXEC:

```
TYPE=type, [subtype], FOCEXEC=fex[(parameters ...)], [TARGET=frame,]
[ALT='tooltip_text',] $
```

For a drilldown hyperlink to a URL:

```
TYPE=type, [subtype], URL=url[(parameters ...)], [TARGET=frame,]
[ALT='tooltip_text',] $
```

where:

type

Identifies the report component that you select in the Web browser to execute the link. The TYPE attribute and its value must appear at the beginning of the declaration.

subtype

Are any additional attributes, such as COLUMN, LINE, or ITEM, that are needed to identify the report component that you are formatting.

fex

Identifies the file name of the linked procedure to run when you select the report component.

url

Identifies any valid URL, including a URL that specifies a WebFOCUS Servlet program, or the name of a report column enclosed in parentheses whose value is a valid URL to which the link will jump.

parameters

Values that are passed to the report or URL.

frame

Identifies the target frame in the Web page in which the output from the drill-down link is displayed.

tooltip_text

Is the informational text to display when the mouse hovers over the hyperlink.

Usage Notes for Drilldown Hyperlinks With EXL2K Report Output

The JAVASCRIPT and IMAGE drilldown options are not supported with format EXL2K.

Providing a Tooltip for a Drilldown Link in a Footing

The following report request summarizes product sales and sorts the data by region, state, and store code. The store code also displays in the subfootings where links display to detailed reports about the sales for the store (by product or by date). Each line of the subfoot contains two text objects and one embedded field.

```
TABLE FILE GGSALES
HEADING
"Sales Report"
SUM DOLLARS/I08M
BY REGION BY ST BY STCD
ON STCD SUBFOOT
"View Store <STCD Sales By Product"
" "
"View Store <STCD Sales By Date"
ON TABLE PCHOLD FORMAT EXL2K
ON REGION PAGE-BREAK
ON TABLE SET PAGE-NUM OFF
ON TABLE SET STYLE *
TYPE=HEADING, SIZE=12, STYLE=BOLD, $
TYPE=SUBFOOT, LINE=1, OBJECT=TEXT, ITEM=2,
FOCEXEC=PRDSALES(STOREID=STCD), ALT='Product Sales',$
TYPE=SUBFOOT, LINE=3, OBJECT=TEXT, ITEM=2,
FOCEXEC=HSTSALES(STOREID=STCD),ALT='Sales History', $
ENDSTYLE
END
```

Using StyleSheet declarations, the subfoot phrase **Sales By Product** links to a second procedure named PRDSALES and passes it the value of STCD displayed in the subfoot. The subfoot phrase **Sales By Date** links to a procedure named HSTSALES and passes it the value of STCD displayed in the subfoot. The ALT attributes in the StyleSheet declarations for the hyperlinks provide informational messages.

The linked PRDSALES report follows:

```
TABLE FILE GGSALES
SUM UNITS
BY STCD
BY PRODUCT
WHERE STCD = '&STOREID'
ON TABLE SET PAGE-NUM OFF
ON TABLE PCHOLD FORMAT EXL2K
ON TABLE SET STYLE *
TYPE=REPORT, GRID=OFF, $
ENDSTYLE
END
```

The linked HSTSALES report follows:

```
TABLE FILE GGSALES
SUM UNITS
BY STCD
BY DATE
WHERE STCD = '&STOREID'
ON TABLE SET PAGE-NUM OFF
ON TABLE PCHOLD FORMAT EXL2K
ON TABLE SET STYLE *
TYPE=REPORT, GRID=OFF, $
ENDSTYLE
END
```

The first page of output for the main report follows. If your mouse hovers over the Sales By Date link, the informational text **Sales History** displays:

	A	B	C	D
1	Sales Report			
2	Region	State	Store ID	Dollar Sales
3	Midwest	IL	R1020	\$3,924,401
4	View Store R1020 Sales By Product			
5				
6	View Store R1020 Sales By Date			
7		MO	R1250	\$2,761,286
8	View Store R1250 Sales By Product			
9				
10	View Store R1250 Sales By Date			
11		TX	R1019	\$3,714,978
12	View Store R1019 Sales By Product			
13				
14	View Store R1019 Sales By Date			
15	Sales Report			
16	Region	State	Store ID	Dollar Sales
17	Northeast	CT	R1100	\$3,782,049
18	View Store R1100 Sales By Product			
19				
20	View Store R1100 Sales By Date			
21		MA	R1044	\$3,707,986
22	View Store R1044 Sales By Product			

Embedding a WebFOCUS Report in an Excel 2000/2003 Workbook

Using an optional feature of Excel called Microsoft Web Query, you can embed a WebFOCUS report in a customized Excel worksheet that already contains styling, formulas, and macros.

i Note: You can also embed a WebFOCUS report in an Excel workbook using WebFOCUS Quick Data. WebFOCUS Quick Data is a Microsoft Office Add-in that enables you to connect Microsoft Excel directly to WebFOCUS reporting tools where you can access and analyze all of your enterprise data. For information about installing and using WebFOCUS Quick Data, see TM4693: *Using the WebFOCUS Quick Data Add-In*.

Microsoft Web Query uses a URL to embed external data or an HTML page into the worksheet. Since you can easily construct a URL that calls the WebFOCUS engine, you can

use this URL as the source of your query. Then, instead of following the typical reporting path in which you execute a request from the browser and display the output in an Excel worksheet that conforms to the formatting of the report request, you can execute a request that returns HTML from a query *inside* an existing Excel worksheet whose content and layout you can control in Excel. Said another way, instead of having WebFOCUS push the report into the worksheet, you can have Excel pull the report into the worksheet. This "pull" technique supports the delivery of real time data directly into your own customized worksheets.

The process has two parts:

- Create the WebFOCUS report, if you have not already done so.
- Designate the area in your worksheet into which Microsoft Web Query will pull the report, and provide Query with specifications for locating and embedding it.

You must have a web browser installed on your PC to take advantage of this technique.

The following is a customized worksheet that was created using this technique. Notice that it includes logos (images), a report, formulas, and an Excel graph. There are two formulas added outside of the query range that sum and average the data brought back by the query. The report is generated as the result of a web query in the area of the worksheet that has been designated to contain it. The graph is also based on the results of this query. Each time the query is refreshed, the formulas and the graph update as well.

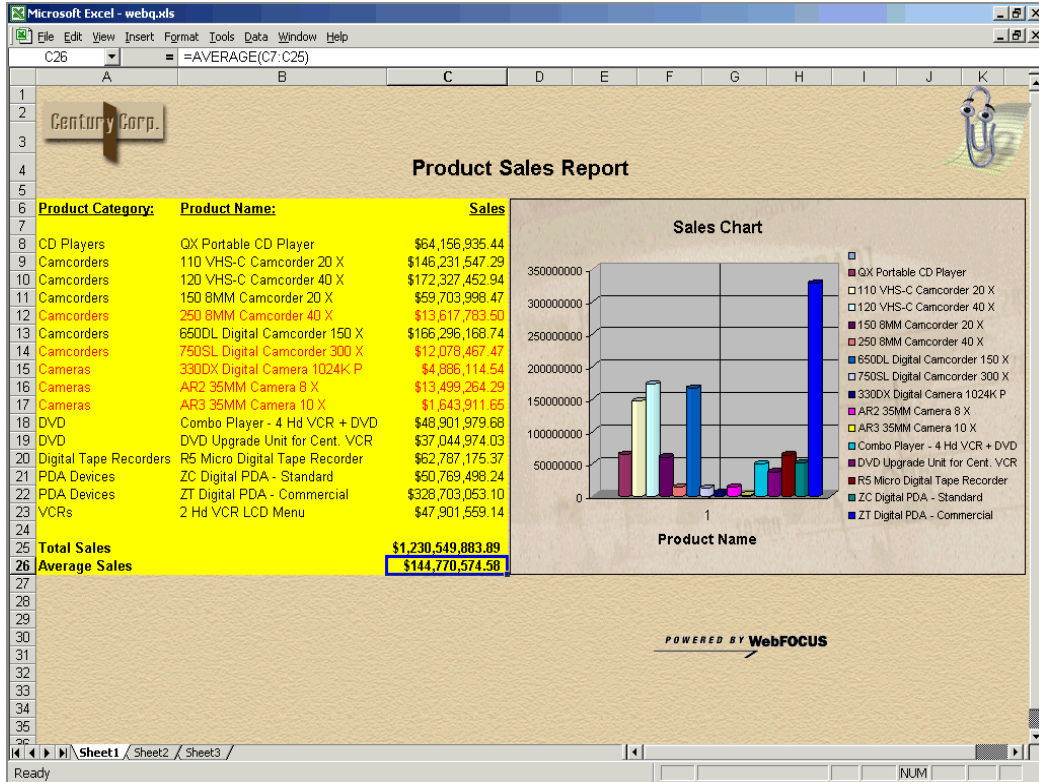

After you understand the rudiments of this technique, you will be able to adapt it to suit your preferred way of working with Excel. For example, you can:

- Pull a WebFOCUS report into an Excel worksheet that you have already customized with logos (images), a report, formulas, or an Excel graph.
- or
- Open a blank worksheet, pull in a WebFOCUS report, and then customize the worksheet as you like.

You can implement this technique, with some variations, in Excel 2000/2003 and Excel 97. For illustrations, see [Using Excel Display Formats: XLSX, EXL2K, EXL97](#) and [Using Excel Display Formats: XLSX, EXL2K, EXL97](#). For details on how to set up a web query in Excel 2000 or Excel 97, see your Microsoft Excel documentation.

Note: Microsoft Web Query may not have been installed by default. If you have not already installed it, you will be prompted to install Web Query the first time you attempt to access the feature. Just follow the install instructions provided.

Embedding a WebFOCUS Report in a Customized Excel 2000/2003 Worksheet

This example creates the HTML report, then uses Web Query to set up the customized worksheet to receive it.

Step 1: Create the WebFOCUS report

Create and save the following request, webq.fex, which you will embed in a customized Excel 2000/2003 worksheet: The numbers to the left of each line of code correspond to annotations that follow the request.

```
1. TABLE FILE CENTORD
2. SUM LINEPRICE AS 'Sales'
3. BY PRODCAT
4. BY PRODNAME
5. ON TABLE PCHOLD FORMAT HTML
6. ON TABLE SET HTMLCSS ON
7. ON TABLE SET BYDISPLAY ON
8. ON TABLE SET PAGE-NUM TOP
9. ON TABLE SET STYLESHEET *
10. TYPE=REPORT, FONT=ARIAL, GRID=OFF, BACKCOLOR=YELLOW, $
11. TYPE=TITLE, STYLE=BOLD, $
12. TYPE=DATA, COLOR=RED, WHEN=LINEPRICE LT 15000000, $
13. ENDSTYLE
14. END
```

Line 1 identifies the sample data source, CENTORD, which contains sales data for the Century corporation.

Lines 2-4 define display and sorting requirements for the report.

Lines 5-6 define the output format as HTML and turn on Cascading Style Sheets, a feature that increases the efficiency and overall styling capabilities of HTML.

! **Important:** The report must be in HTML format and not EXL2K. This is because Web Query imports fully formatted HTML pages or individual HTML tables into a worksheet. Executing an EXL2K request from a query will not return any data to the worksheet.

Line 7 sets BYDISPLAY to ON. This optional setting ensures that repeated sort values in the report are populated with data.

By default, repeated sort values in vertical columns (or BY fields) are suppressed in a WebFOCUS report, leaving blank fields in the report. This behavior is not desirable for Excel reports, which are designed to work with data that is repeated in every row to which it applies. A blank column or row can produce misleading results when sorting data.

Line 8 turns off page numbering and removes any extra lines generated above the column titles.

Lines 9-13 specify styling attributes for the report: background color, conditional styling, and some other miscellaneous styling have been designated. Styling, including drill-downs, carry over into Excel.

Step 2: Designate the area in the worksheet into which Web Query will pull the report

In your worksheet, you designate the area where you want your WebFOCUS report to be displayed. You can designate a cell and let Excel determine how much space to allot to the report or you can specify a range of cells to limit the placement. For some techniques that may help you evaluate and control space requirements, see [Using Excel Display Formats: XLSX, EXL2K, EXL97](#).

1. Open a worksheet and highlight the cell or range.
2. From the Data menu, select **Get External Data**, then select **New Web Query**.

The New Web Query dialog box opens.

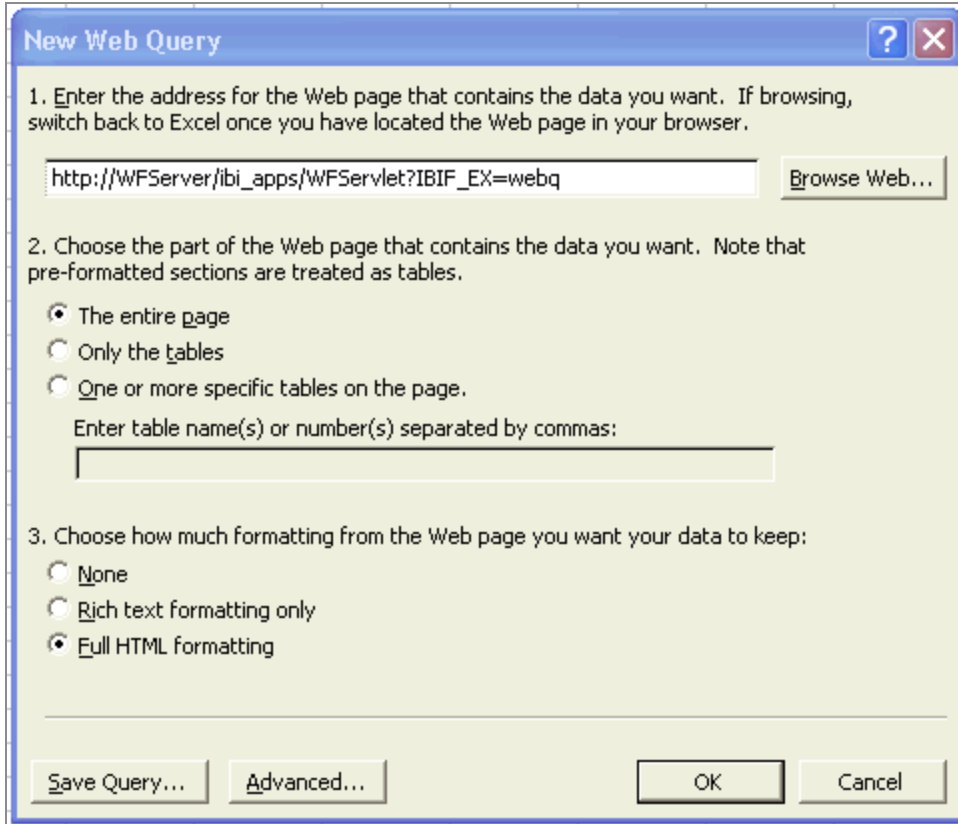

3. In this dialog box:

- a. Specify a URL that points to the WebFOCUS server. The URL needs to be constructed as a call to the WebFOCUS Servlet and contain any appropriate parameters that need to be passed.

In the illustration, the code

```
http://servername/ibi_apps/WFServlet?IBIF_ex=webq
```

calls the WebFOCUS Servlet and requests the procedure called webq.fex. This is the report created in Step 1.

Keep in mind that you may also need to pass a user ID and password to get to a secure server. You must add parameters to the query manually. To do this, save the query as an .iqy file and manually add parameters to the URL request. For details, see [Using Excel Display Formats: XLSX, EXL2K, EXL97](#).

- b. Specify whether the entire page or only the tables should be extracted from the requested file. In this example, select the entire page.

Since WebFOCUS HTML reports are generated using HTML tables, you can select either **The entire page** or **Only the tables**. (At the present time, you cannot identify individual tables in a WebFOCUS HTML report.)

- c. Select **Full HTML formatting** to ensure that all styling transfers to the worksheet. This step is important if you want a styled report to be carried over to Excel.
- d. Click **OK**.

The Returning External Data dialog box opens.

4. Indicate the range of cells into which you want the data to be returned in your worksheet.

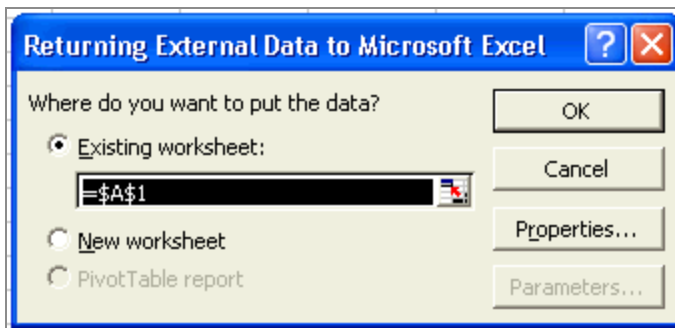

5. Click the **Properties** button in the Returning External Data dialog box. The External Data Range Properties dialog box opens.

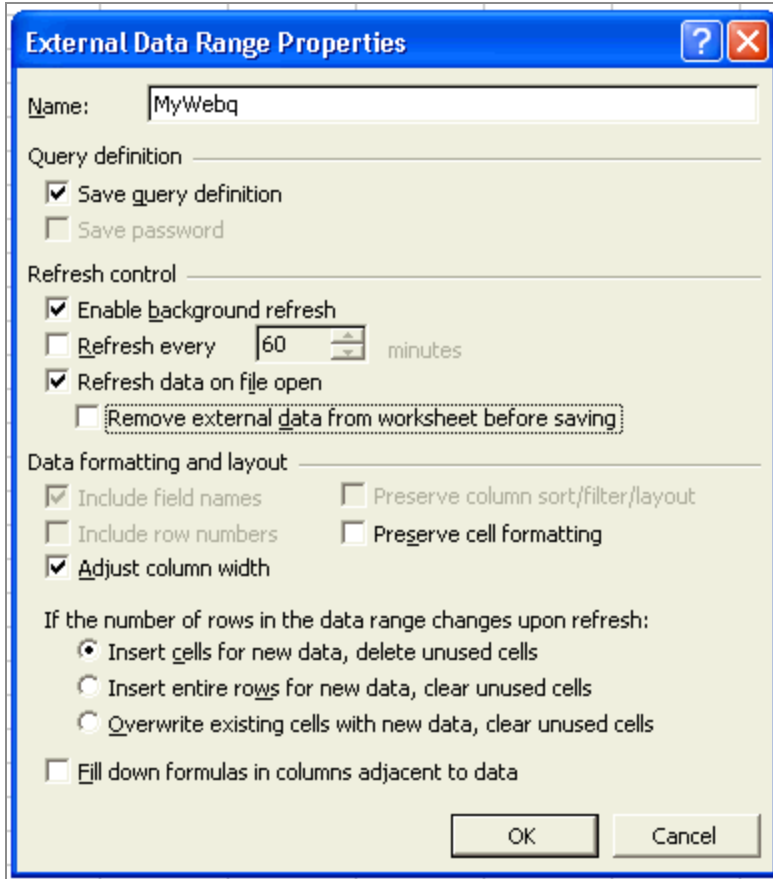

Name the query and set its refresh behavior. For example, you can set the query to automatically refresh every time the worksheet opens. (Note that you can also set these properties after the initial execution.)

Click **OK** to run the web query. The report is pulled into the area of the worksheet that has been designated to contain it.

6. Save the worksheet with the embedded query. (Note that if you click the **Save Query** button, the query information will be saved as an .iqy file that you can use again with other worksheets.)
7. After the query is created and executed, you can customize your worksheet as much as you like.

i Note: You only need to run Web Query once to embed a query in a worksheet. After it is executed, the static data stays in the worksheet as a placeholder for the query. However, as long as you are connected to your network, the internet, or whatever other connection mechanism is in effect for your application, when you open your local worksheet, WebFOCUS delivers the latest information directly into your own customized worksheet. You can also click the **Refresh Data** option at anytime to update the information.

If you wish to delete a query, delete all the query data in the worksheet.

For an illustration of a customized worksheet that contains the report created in step 1, see [Using Excel Display Formats: XLSX, EXL2K, EXL97](#). The worksheet includes logos (images), a report, formulas, and an Excel graph. The graph is also based on the results of this query. Each time the query is refreshed, the formulas and the graph update as well.

Tips for Populating Excel Worksheets With WebFOCUS Reports

In addition to the method described in the example [Using Excel Display Formats: XLSX, EXL2K, EXL97](#), you can employ other techniques to take advantage of Web Query in your worksheet. For example, if you have an existing worksheet with a lot of pre-defined elements, you may need to run the query in a separate worksheet and see how much space it will take up before adding it to the main "working area" of the worksheet. It is a good idea to designate one particular worksheet for your query and have everything else refer to the data via formulas on another worksheet.

Another approach is to include everything in the same worksheet. Other surrounding elements in the worksheet should automatically reposition when the data comes back, but you may want to leave a buffer area around the query to ensure sufficient space for the report output.

Creating a Compound Excel Report

Excel Compound Reports generate multiple worksheet reports using the EXL2K output format.

The syntax of Excel Compound Reports is identical to that of PDF Compound Reports. By default, each of the component reports from the compound report is placed in a new Excel worksheet (analogous to a new page in PDF). If the NOBREAK keyword is used, the next report follows the current report on the same worksheet (analogous to starting the report on the same page in PDF).

Output is generated in Microsoft Web Archive format. This format is labeled Single File Web Page in the Excel Save As dialog. Excel provides the conventionally given file suffixes: .mht or .mhtml. FOCUS uses the same .xht file type that is used for EXL2K reports.

The components of an Excel compound report can be FORMULA or PIVOT reports (subject to the restrictions). They cannot be Table of Contents (TOC) reports.



Note: Excel 2002 (Office XP) or higher must be installed. Excel Compound Reports will not work with earlier versions of Excel since they do not support the Web Archive file format.

Guidelines for Using the OPEN, CLOSE, and NOBREAK Keywords and SET COMPOUND

As with PDF, the keywords OPEN, CLOSE, and NOBREAK are used to control Excel compound reports. They can be specified with the HOLD command or with a separate SET COMPOUND command.

- OPEN is used on the first report of a sequence of component reports to specify that a compound report be produced.
- CLOSE is used to designate the last report in a compound report.
- NOBREAK specifies that the next report be placed on the same worksheet as the current report. If it is not present, the default behavior is to place the next report on a separate worksheet.

NOBREAK may appear with OPEN on the first report, or alone on a report between the first and last reports. (Using CLOSE is irrelevant, since it refers to the placement of the next report, and no report follows the final report on which CLOSE appears.)

- When used with the HOLD/PCHOLD syntax, the compound report keywords OPEN, CLOSE, and NOBREAK must appear immediately after FORMAT EXL2K, and before any

additional keywords, such as FORMULA or PIVOT. For example, you can specify:

- ON TABLE HOLD FORMAT EXL2K OPEN
 - ON TABLE HOLD AS MYHOLD FORMAT EXL2K OPEN NOBREAK
 - ON TABLE HOLD FORMAT EXL2K NOBREAK FORMULA
 - ON TABLE HOLD FORMAT EXL2K CLOSE PIVOT PAGEFIELDS COUNTRY
- As with PDF compound reports, compound report keywords can be alternatively specified using SET COMPOUND:
 - SET COMPOUND = OPEN
 - SET COMPOUND = 'OPEN NOBREAK'
 - SET COMPOUND = NOBREAK
 - SET COMPOUND = CLOSE

Guidelines for Producing Excel Compound Reports

- **Pivot Tables and NOBREAK.** Pivot Table Reports may appear in compound reports, but they may not be combined with another report on the same worksheet using NOBREAK.
- **Naming of Worksheets.** The default worksheet tab names will be Sheet1, Sheet2, and so on. You have the option to specify a different worksheet tab name by using the TITLETEXT keyword in the stylesheet. For example:

```
TYPE=REPORT, TITLETEXT='Summary Report', $
```

Excel limits the length of worksheet titles to 31 characters. The following special characters cannot be used: ':', '?', '*', and '/'.

- **File Names and Formats.** The output file name (AS name, or HOLD by default) is obtained from the first report of the compound report (the report with the OPEN keyword). Output file names on subsequent reports are ignored.

The HOLD FORMAT syntax used in the first component report in a compound report

applies to all subsequent reports in the compound report, regardless of their format.

- **NOBREAK Behavior.** When NOBREAK is specified, the following report appears on the row immediately after the last row of the report with the NOBREAK. If additional spacing is required between the reports, a FOOTING or an ON TABLE SUBFOOT can be placed on the report with the NOBREAK, or a HEADING or an ON TABLE SUBHEAD can be placed on the following report. This allows the most flexibility, since if blank rows were added by default there would be no way to remove them.

Creating a Simple Compound Report Using EXL2K

```
SET PAGE-NUM=OFF
TABLE FILE CAR
HEADING
"Sales Report"
" "
SUM SALES
BY COUNTRY
ON TABLE SET STYLE *
type=report, titletext='Sales Rpt', $
type=heading, size=18, $
ENDSTYLE
ON TABLE HOLD AS EX1 FORMAT EXL2K OPEN
END
```

```
TABLE FILE CAR
HEADING
"Inventory Report"
" "
SUM RC
BY COUNTRY
ON TABLE SET STYLE *
type=report, titletext='Inv. Rpt', $
type=heading, size=18, $
ENDSTYLE
ON TABLE HOLD AS EX1 FORMAT EXL2K
END
```

```
TABLE FILE CAR
HEADING
"Cost of Goods Sold Report"
```

```

" "
SUM DC
BY COUNTRY
ON TABLE SET STYLE *
type=report, titletext='Cost Rpt', $
type=heading, size=18, $
ENDSTYLE
ON TABLE HOLD AS EX1 FORMAT EXL2K CLOSE
END

```

The output for each tab in the Excel worksheet is:

Sales Report		
A	B	C
Sales Report		
2		
3	COUNTRY	SALES
4	ENGLAND	12000
5	FRANCE	0
6	ITALY	30200
7	JAPAN	78030
8	W GERMANY	88190
9		
10		
11		
12		
13		
14		
15		
16		
17		
18		

Inventory Report		
A	B	C
Inventory Report		
2		
3	COUNTRY	RETAIL_COST
4	ENGLAND	45,319
5	FRANCE	5,610
6	ITALY	51,065
7	JAPAN	6,478
8	W GERMANY	64,732
9		
10		
11		
12		
13		
14		
15		
16		
17		
18		

A1		fx Cost of Goods Sold Report	
A		B	
1	Cost of Goods Sold Report		
2			
3	COUNTRY		DEALER_COST
4	ENGLAND		37,853
5	FRANCE		4,631
6	ITALY		41,235
7	JAPAN		5,512
8	W GERMANY		54,563
9			
10			
11			
12			
13			
14			
15			
16			
17			
18			

Navigation: Sales Rpt / Inv. Rpt / Cost Rpt

Creating a Compound Report With Pivot Tables and Formulas

```

SET PAGE-NUM=OFF
TABLE FILE CAR
HEADING
"Sales Report"
" "
PRINT RCOST
BY COUNTRY
ON TABLE SET STYLE *
type=report, titletext='Sales Rpt', $
type=heading, size=18, $
ENDSTYLE
ON TABLE HOLD AS PIV1 FORMAT EXL2K OPEN
END

```

```

TABLE FILE CAR
HEADING
"Inventory Report"
" "
PRINT SALES
BY COUNTRY
ON TABLE SET STYLE *
type=report, titletext='Inv. Rpt', $

```

```

type=heading, size=18, $
ENDSTYLE
ON TABLE HOLD AS PPPP FORMAT EXL2K PIVOT
PAGEFIELDS TYPE SEATS
CACHEFIELDS MODEL MPG RPM
END

```

```

TABLE FILE CAR
SUM RCOST
BY COUNTRY BY CAR BY MODEL BY TYPE BY SEATS SUMMARIZE
ON MODEL SUB-TOTAL
ON TABLE HOLD AS XFOCB FORMAT EXL2K FORMULA
END

```

```

TABLE FILE CAR
HEADING
"Cost of Goods Sold Report"
" "
PRINT DCOST
BY COUNTRY
ON TABLE SET STYLE *
type=report, titletext='Cost Rpt', $
type=heading, size=18, $
ENDSTYLE
ON TABLE HOLD AS ONE FORMAT EXL2K CLOSE PIVOT
PAGEFIELDS RCOST
CACHEFIELDS MODEL TYPE SALES ACCEL SEATS
END

```

The output for each tab in the Excel worksheet is:

Sales Report	
COUNTRY	RETAIL_COST
ENGLAND	8,878
	13,491
	17,850
	5,100
FRANCE	5,610
ITALY	5,925
	6,820
	6,820
	31,500
JAPAN	3,139
	3,339
W GERMANY	5,970
	5,940
	6,355
	13,752
	14,123
	9,097
	9,495

Inventory Report	
COUNTRY	Total
ENGLAND	12000
FRANCE	0
ITALY	30200
JAPAN	78030
W GERMANY	88190

	A	B	C	D	E	F	G
1	COUNTRY	CAR	MODEL	BODYTYPE	SEATS	RETAIL_COST	
2	ENGLAND	JAGUAR	V12XKE AUTO	CONVERTIBLE	2	8,878	
3	*TOTAL SEATS 2					8,878	
4	*TOTAL BODYTYPE CONVERTIBLE					8,878	
5	*TOTAL MODEL V12XKE AUTO					8,878	
6			XJ12L AUTO	SEDAN	5	13,491	
7	*TOTAL SEATS 5					13,491	
8	*TOTAL BODYTYPE SEDAN					13,491	
9	*TOTAL MODEL XJ12L AUTO					13,491	
10	*TOTAL CAR JAGUAR					22,369	
11		JENSEN	INTERCEPTOR III	SEDAN	4	17,850	
12	*TOTAL SEATS 4					17,850	
13	*TOTAL BODYTYPE SEDAN					17,850	
14	*TOTAL MODEL INTERCEPTOR III					17,850	
15	*TOTAL CAR JENSEN					17,850	
16		TRIUMPH	TR7	HARDTOP	2	5,100	
17	*TOTAL SEATS 2					5,100	
18	*TOTAL BODYTYPE HARDTOP					5,100	
19	*TOTAL MODEL TR7					5,100	
20	*TOTAL CAR TRIUMPH					5,100	
21	*TOTAL COUNTRY ENGLAND					45,319	
22	FRANCE	PEUGEOT	504 4 DOOR	SEDAN	5	5,610	
23	*TOTAL SEATS 5					5,610	
24	*TOTAL BODYTYPE SEDAN					5,610	

Cost of Goods Sold Report	
A	B
Sum of DEALER_COST	
COUNTRY	Total
ENGLAND	37,853
FRANCE	4,631
ITALY	41,235
JAPAN	5,512
W GERMANY	54,563

Creating a Compound Report Using NOBREAK

In this example, the first two reports are on the first worksheet, and the last two reports are on the second worksheet, since NOBREAK appears on both the first and third reports.

```
TABLE FILE GGSALLES
HEADING
"Report 1: Coffee - Budget"
```

```
SUM BUDDOLLARS BUDUNITS COLUMN-TOTAL AS 'Total'  
BY REGION  
IF CATEGORY EQ Coffee  
ON TABLE PCHOLD FORMAT EXL2K OPEN NOBREAK  
ON TABLE SET STYLE *  
type=report, font=Arial, size = 10, style=normal, $  
type=title, style=bold, $  
type=heading, size=12, style=bold, color=blue, $  
type=grandtotal, style=bold, $  
END
```

```
TABLE FILE GGSALES  
HEADING  
" "  
"Report 2: Coffee - Actual "  
SUM DOLLARS UNITS COLUMN-TOTAL AS 'Total'  
BY REGION  
IF CATEGORY EQ Coffee  
ON TABLE PCHOLD FORMAT EXL2K  
ON TABLE SET STYLE *  
type=report, font=Arial, size=10, style=normal, $  
type=grandtotal, style=bold, $  
type=heading, size=12, style=bold, color=blue, $  
END
```

```
TABLE FILE GGSALES  
HEADING  
"Report 3: Food - Budget"  
SUM BUDDOLLARS BUDUNITS COLUMN-TOTAL AS 'Total'  
BY REGION  
IF CATEGORY EQ Food  
ON TABLE PCHOLD FORMAT EXL2K NOBREAK  
ON TABLE SET STYLE *  
type=REPORT, font=Arial, size=10, style=normal, $  
type=HEADING, style=bold, size=12, color=blue, $  
type=title, style=bold, $  
type=grandtotal, style=bold, $  
END
```

```
TABLE FILE GGSALES  
HEADING  
" "  
"Report 4: Food - Actual"
```

```

SUM DOLLARS UNITS COLUMN-TOTAL AS 'Total'
BY REGION
IF CATEGORY EQ Food
ON TABLE PCHOLD FORMAT EXL2K CLOSE
ON TABLE SET STYLE *
type=report, font=Arial, size=10, $
type=title, style=bold, $
type=heading,size=12, style=bold, color=blue,$
type=grandtotal, style=bold, $
END

```

The output is:

	A	B	C
1	Report 1: Coffee - Budget		
2	Region	Budget Dollars	Budget Units
3	Midwest	4086032	335526
4	Northeast	4252462	335920
5	Southeast	4431429	355693
6	West	4523963	358784
7	Total	17293886	1385923
8			
9	Report 2: Coffee - Actual		
10	Region	Dollar Sales	Unit Sales
11	Midwest	4178513	332777
12	Northeast	4164017	335778
13	Southeast	4415408	350948
14	West	4473517	356763
15	Total	17231455	1376266

	A	B	C
1	Report 3: Food - Budget		
2	Region	Budget Dollars	Budget Units
3	Midwest	4220721	339263
4	Northeast	4453907	351431
5	Southeast	4409288	351509
6	West	4183244	335361
7	Total	17267160	1377564
8			
9	Report 4: Food - Actual		
10	Region	Dollar Sales	Unit Sales
11	Midwest	4338271	341414
12	Northeast	4379994	353368
13	Southeast	4308731	349829
14	West	4202337	340234
15	Total	17229333	1384845

Transferring EXL2K Formatted Files Using FTP

After creating an EXL2K formatted file, you must transfer it from the mainframe to your PC to view and use it. The following illustrates the process of using FTP in Microsoft Windows to retrieve the files from the mainframe:

```
C:\temp\work>ftp ibimvs
Connected to ibimvs.ibi.com.
220-FTPD1 IBM FTP CS V2R10 at IBIMVS.IBI.COM, 15:24:50 on 2003-11-06.
220 Connection will close if idle for more than 5 minutes.
User (ibimvs.ibi.com:(none)): userid1
331 Send password please.
Password:
230 USERID1 is logged on. Working directory is "USERID1.".
ftp> get pivotmvs.xht pivot.xht
200 Port request OK.
125 Sending data set USERID1.PIVOTMVS.XHT
250 Transfer completed successfully.
ftp: 8387 bytes received in 0.14Seconds 59.48Kbytes/sec.
ftp> get pivotmvs.xml pivot.xml
200 Port request OK.
125 Sending data set USERID1.PIVOTMVS.XML
250 Transfer completed successfully.
ftp: 1940 bytes received in 0.16Seconds 12.44Kbytes/sec.
ftp> by
221 Quit command received. Goodbye.
```

Important Considerations for Transferring EXL2K-generated Files

- You must transfer the file as an ASCII file.
- Whatever name you give the file ("HOLD" or an "asname" assigned with a HOLD AS phrase) must be kept for the transferred file. The HOLD EXL2K PIVOT operation actually produces two files; an "asname.XHT" data file and an "asname\$.XML" PivotTable file.
- Before the FTP operation, issue a DYNAM FREE for both the **asname** and the **asname\$** ddnames.

Viewing a Report in EXL97 Format

The EXL97 format allows you to view reports in Excel 97, which supports full styling.

Format EXL97 is fully compatible with Excel 2000, Excel 2002, and Excel 2003.

i Note: Although format EXL97 is available, there are some limitations when compared to the EXL2K formats. See [Using Excel Display Formats: XLSX, EXL2K, EXL97](#). Future enhancements in the area of Excel integration will primarily be made to the EXL2K and XLSX formats. We recommend upgrading to Excel 2003 or higher so you can take full advantage of our Excel integration, as well as all future enhancements.

Create a Styled Excel 97 File

To produce an Excel 97 spreadsheet, create a FOCUS report using the Excel 97 HOLD option and then transfer the output file to your browser and open it in Excel 97. The HOLD syntax is

```
[ON TABLE] HOLD [AS filename] FORMAT EXL97
```

where:

EXL97

Creates an Excel-formatted HTML file, with an extension of .HTM, which may include styling based on FOCUS StyleSheet features. The MIME type assigned automatically designates Excel as the active application for this file type. Before you can see or work with this file you must transfer it to your PC.

Creating an EXL97 Output File

The following example shows how to create a report in EXL97 format based on the contents of CENTORD, with conditional styling:

```
TABLE FILE CENTORD
HEADING
"Order Revenue"
"Styled Report in Excel 97"
" "
SUM ORDER_DATE LINEPRICE AS 'Order,Total:'
BY HIGHEST 10 ORDER_NUM
ON TABLE SET PAGE-NUM OFF
ON TABLE HOLD FORMAT EXL97
ON TABLE SET STYLE *
TYPE=HEADING, COLOR=NAVY, SIZE=10, $
TYPE=HEADING, LINE=2, COLOR=RED, $
TYPE=DATA, BACKCOLOR=AQUA, STYLE=BOLD, WHEN=LINEPRICE GT 200000, $
TYPE=TITLE, STYLE=BOLD, $
ENDSTYLE
END
```

The output is:

	A	B	C
1	Order Revenue		
2	Styled Report in Excel 97		
3			
4	Order	Date	Order
5	Number:	Of Order:	Total:
6	94710	1/2/2001	\$406,964.24
7	94680	1/2/2001	\$421,916.60
8	94670	1/2/2001	\$513,868.76
9	94550	1/2/2001	\$496,323.64
10	94530	1/2/2001	\$3,472.41
11	94520	1/2/2001	\$261,808.72
12	94490	12/31/2000	\$633,723.06
13	94460	1/2/2001	\$3,872.39
14	94430	1/2/2001	\$3,033.38
15	94410	1/2/2001	\$2,337.28

When you use Microsoft Internet Explorer and Excel 97, the Excel client opens in the background and the report launches in your browser. Depending on browser settings, you may see the Excel application open and minimized while viewing your report. Leave Excel open when viewing the spreadsheet. In Excel 97, you will be prompted to save the document as a Microsoft Excel Workbook with an .xls extension. This saves the file as a binary Excel document.

Limitations for FORMAT EXL97

- This format is only compatible with Excel 97 or higher. This format is not compatible with Excel 95 or any versions of Excel prior to Excel 95.
- Excel 97 does not support Cascading Style Sheets (CSS). Any styling specified in a report that uses CSS (SET HTMLCSS=ON) will not be respected in Excel 97. The WRAP=*n* feature is not supported with EXL97 since this feature requires CSS.
- FOCUS uses nested HTML tables when generating a heading, which may cause a problem in EXL97. As an alternative, specify HEADALIGN=BODY in your StyleSheets for all HEADING objects including FOOTING, SUBHEAD, and SUBFOOT commands. This creates the heading as a separate table.
- Page numbers display by default and are placed in the heading. We recommend that you turn page numbering off (SET PAGE-NUM=OFF).
- All numeric and date formatting options that are not supported for EXL2K are also

not supported for EXL97. In addition, negative numbers displayed with brackets, trailing zeroes after the decimal, and leading zeros will not display with EXL97 reports. Note that dates are typically translated into Excel's General format, which can cause problems with sorting and other Excel features.

- PivotTables are not supported with EXL97.

Embedding a WebFOCUS Report in an Excel 97 Spreadsheet

WebFOCUS can integrate with Excel 97 to give you a completely customizable spreadsheet with styling, drill-downs, and formulas.

In an effort to integrate Microsoft Excel with the web, Microsoft introduced a host of new capabilities in Excel 97, including the ability to import HTML directly into Excel spreadsheets with formulas, styling, and AutoFilters. In addition, Excel 97 offers an optional feature of Excel, Web Query, which enables users to query specific web pages or servers in order to pull live data from the web into their spreadsheets while maintaining worksheet layout and formulas. A query can be set to automatically refresh and even prompt the user for parameters.

In Excel 97, web queries are text files that are created in an editor and saved in the appropriate directory with the extension .iqy. (Unlike Excel 2000/2003, there is no graphical environment in which to create queries. For details, see [Embedding a WebFOCUS Report in an Excel 97 Spreadsheet.](#))

A web query consists of three or four lines of text separated by carriage returns. The IQY file is only needed the first time a query is executed to establish the data location and parameters. After a query is run inside a spreadsheet and the spreadsheet is saved, the query information is always present and can be refreshed at any time.

The process of embedding a WebFOCUS report into an Excel 97 spreadsheet has three parts:

- Create the WebFOCUS report.
- Create the Web Query file.
- Run the Web Query utility to pull the report into the spreadsheet.

Create a Web Query (IQY) File

An IQY file is constructed as follows

```
Type_of_query      [CR]
Version_of_query   [CR]
URL                [CR]
{POST|GET} parameters [CR]
```

where:

Type_of_query

Is Web. Since Web is the default value, this is an optional entry.

Version_of_query

Is the current version of the Web Query software. 1 is the default value. This entry is optional.

URL

Is a required entry that points to the WebFOCUS server. The URL needs to be constructed as a call to the WebFOCUS Servlet and contain any appropriate parameters that need to be passed.

POST parameters

Is the preferred method of retrieving large amounts of data and sending it data back as a separate line of text. For example:

```
http://WFserver/ibi_apps/WFServlet[CR]
PARAM1=value & PARAM2=value
```

GET parameters

Is the preferred method of retrieving smaller amounts of data and appending the data to the URL. For example:

```
http://server/ibi_apps/WFServlet?PARAM1=value&PARAM2=value
```

[CR]

Designates required carriage returns.

Embedding a WebFOCUS Report in an Excel 97 Spreadsheet

Step 1: Create the WebFOCUS Report

Create and save the following fully styled WebFOCUS report as webq97. You will embed this report in an Excel 97 spreadsheet. (For proper styling and execution of the request in Excel 97, ensure that Cascading Style Sheets are not in effect; SET HTMLCSS=OFF is the default value.)

The numbers to the left of each line of code correspond to annotations that follow the request.

```

1. TABLE FILE CENTORD
2. SUM LINEPRICE AS 'Sales'
3. BY YEAR AS 'Year'
4. BY PRODCAT AS 'Category'
5. BY PRODNAME AS 'Product'
6. WHERE YEAR EQ '&YEAR';
7. ON TABLE SET BYDISPLAY ON
8. ON TABLE PCHOLD FORMAT HTML
9. ON TABLE SET PAGE-NUM TOP
10. ON TABLE SET STYLE *
11. TYPE=REPORT, FONT=ARIAL, SIZE=10, GRID=OFF, BACKCOLOR=YELLOW, $
12. TYPE=TITLE, SIZE=11, STYLE=BOLD, $
13. TYPE=DATA, COLOR=RED, WHEN=LINEPRICE LT 15000000, $
14. TYPE=DATA, COLUMN=PRODCAT, FOCEXEC=webq2(PRODCAT=N1), $
15. ENDSTYLE
16. END

```

Line 1 identifies the sample data source, CENTORD, which contains sales data for the Century Corporation.

Lines 2-5 define display and sorting requirements for the report.

Line 6 specifies selection criteria using a variable, &YEAR.

Line 7 sets BYDISPLAY to ON. This setting ensures that repeated sort values in the report are populated with data.

By default, repeated sort values in vertical columns (or BY fields) are suppressed in a WebFOCUS report, leaving blank fields in the report. This behavior is not desirable for Excel

reports, which are designed to work with data that is repeated in every row to which it applies. A blank column or row can produce misleading results when sorting data.

Lines 8 defines the output format as HTML.

! **Important:** The report must be in HTML format and not EXL97. This is because Microsoft Query imports fully formatted HTML pages or individual HTML tables into a spreadsheet. Executing an EXL97 request from a query will not return any data to the spreadsheet.

Line 9 turns off page numbering and removes any extra lines generated above the column titles.

Lines 10-15 specify styling attributes for the report: background color, conditional styling, a drill-down to another procedure, and some other miscellaneous styling have been designated. Styling, including drill-downs, carries over into Excel.

Step 2: Create a Web Query (IQY) File

Open a text editor and create the following web query file

```
1. WEB
2. 1
3. http://WFserver/ibi_apps/WFServlet?IBIF_ex=webq97
   &YEAR=["YEAR","Select Year"]
```

where:

Line 1 identifies this as a Web query.

Line 2 identifies the current version of Microsoft Query.

Line 3 is a typical WebFOCUS request using the GET method. The name of the procedure is webq97. The URL line passes a parameter of YEAR into the procedure. The user will be prompted to supply a value for YEAR. Of course, passing parameters is optional. In the example above, we have a dynamic parameter, but the parameters can be static as well. In other words, hard coded in the IQY file.

Note that carriage returns are required between lines in this file.

After you have constructed the query, save the document with an .iqy extension in the Queries directory under Microsoft Office. For example,

```
<drive>:\Program Files\Microsoft Office\Queries\webq97.iqy
```

Now that the IQY file is ready, you can create the spreadsheet and embed the query.

Step 3: Embed the Query in an Excel 97 Spreadsheet

This example starts with a blank spreadsheet, embeds the query, and then adds the bells and whistles.

1. Open a blank spreadsheet. From the Data menu, select Get External Data, followed by Run Web Query. The Run Query dialog box opens.
2. Locate the IQY file, webq97.iqy, and click the **Get Data** button. The Run Query dialog box opens.

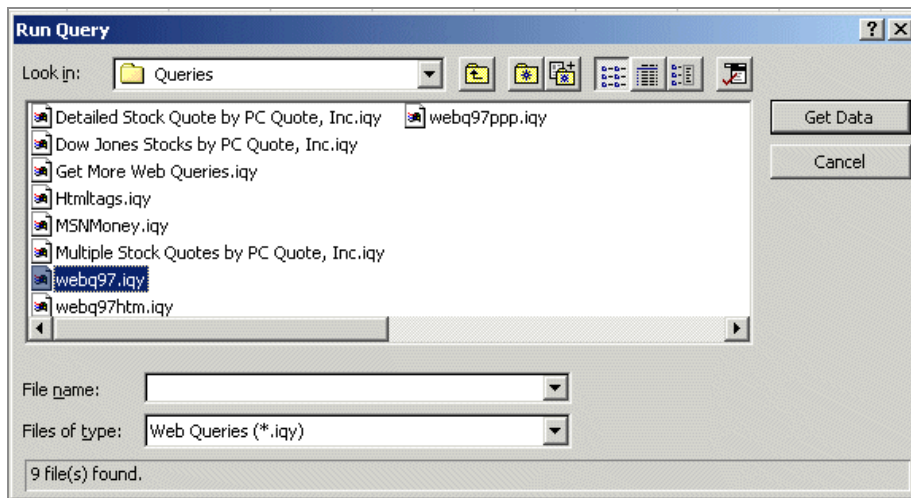

3. Specify where the data will go in your spreadsheet. You can choose a range in the current spreadsheet or you can choose to put the data into a new worksheet. In this case, specify the range as indicated:

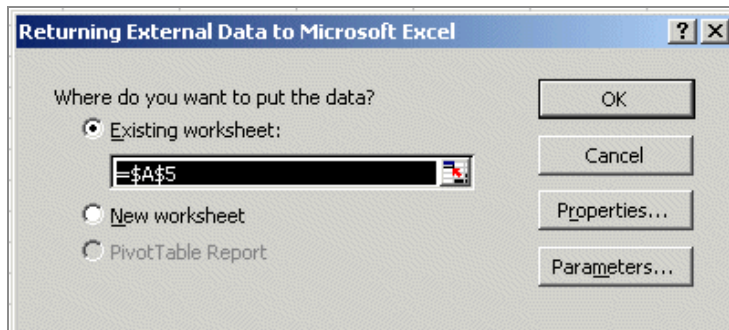

There is no need to set the range in the case of a blank worksheet, however, you may

want to output the data in a new worksheet and use formula references to work with the data.

4. Click the **Properties** button in the Returning External Data dialog box. The External Data Range Properties dialog box opens. Name the query and set its behavior. For example, you can set the query to automatically refresh every time the worksheet opens. (Note that you can also set these properties after the initial execution.)

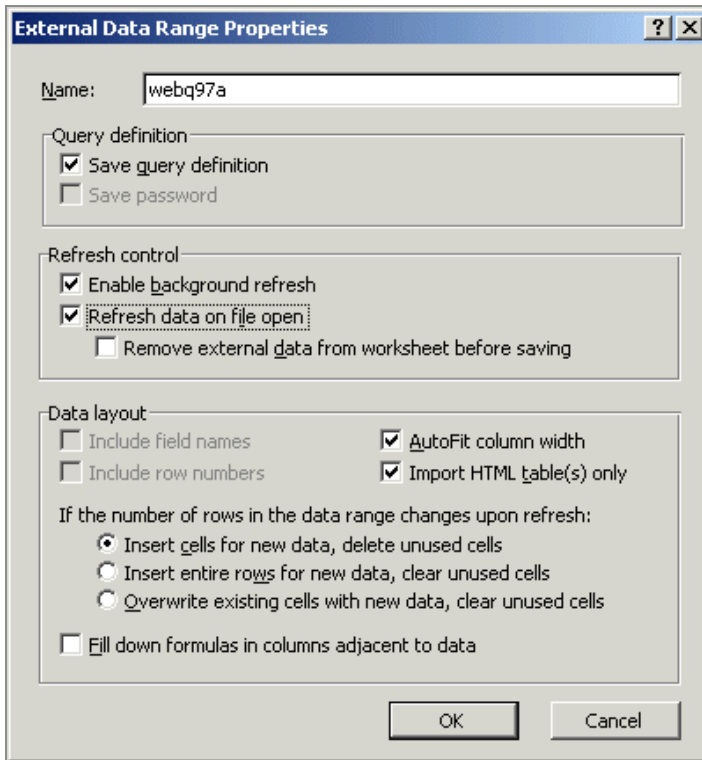

Click **OK**.

5. Click the **Parameters** button in the Returning External Data dialog box to define the behavior for any parameters you may have in your query. You can prompt the user, set a static value, or use a value from a cell in the worksheet. In this example, you will prompt the user for the YEAR.

Enter the value **1999**.

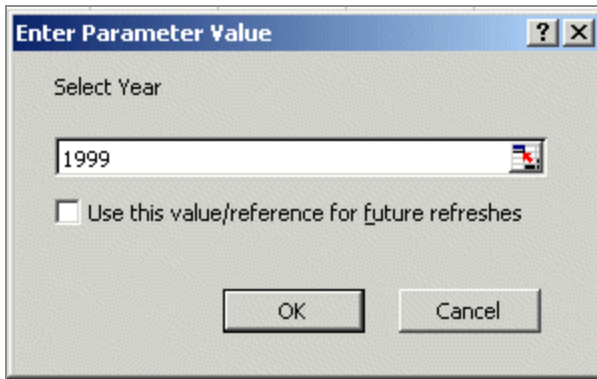

6. After you select the range and set all of the query properties, click the **OK** button.

The query executes and imports the data. The following message is displayed in the spreadsheet:

webq97: Getting Data...

The data appears in the spreadsheet:

Year	Category	Product	Sales
1999	CD Players	OX Portable CD Player	\$18,312,069.22
1999	Camcorders	110 VHS-C Camcorder 20 X	\$38,183,789.86
1999	Camcorders	120 VHS-C Camcorder 40 X	\$44,743,636.56
1999	Camcorders	150 8MM Camcorder 20 X	\$15,957,037.14
1999	Camcorders	250 8MM Camcorder 40 X	\$2,912,009.73
1999	Camcorders	650DL Digital Camcorder 150 X	\$50,045,280.29
1999	Camcorders	750SL Digital Camcorder 300 X	\$2,982,854.36
1999	Cameras	330DX Digital Camera 1024K P	\$1,634,940.00
1999	Cameras	AR2 35MM Camera 8 X	\$4,132,881.06
1999	Cameras	AR3 35MM Camera 10 X	\$401,375.76
1999	DVD	Combo Player - 4 Hd VCR + DVD	\$12,580,446.06
1999	DVD	DVD Upgrade Unit for Cent. VCR	\$9,657,970.46
1999	Digital Tape Recorders	R5 Micro Digital Tape Recorder	\$16,847,562.94
1999	PDA Devices	ZC Digital PDA - Standard	\$15,949,467.30
1999	PDA Devices	ZT Digital PDA - Commercial	\$92,911,484.64
1999	VCRs	2 Hd VCR LCD Menu	\$12,069,279.06

7. Now that the data has been pulled into the spreadsheet, you can add features such as formulas, images, charts, macros, etc.

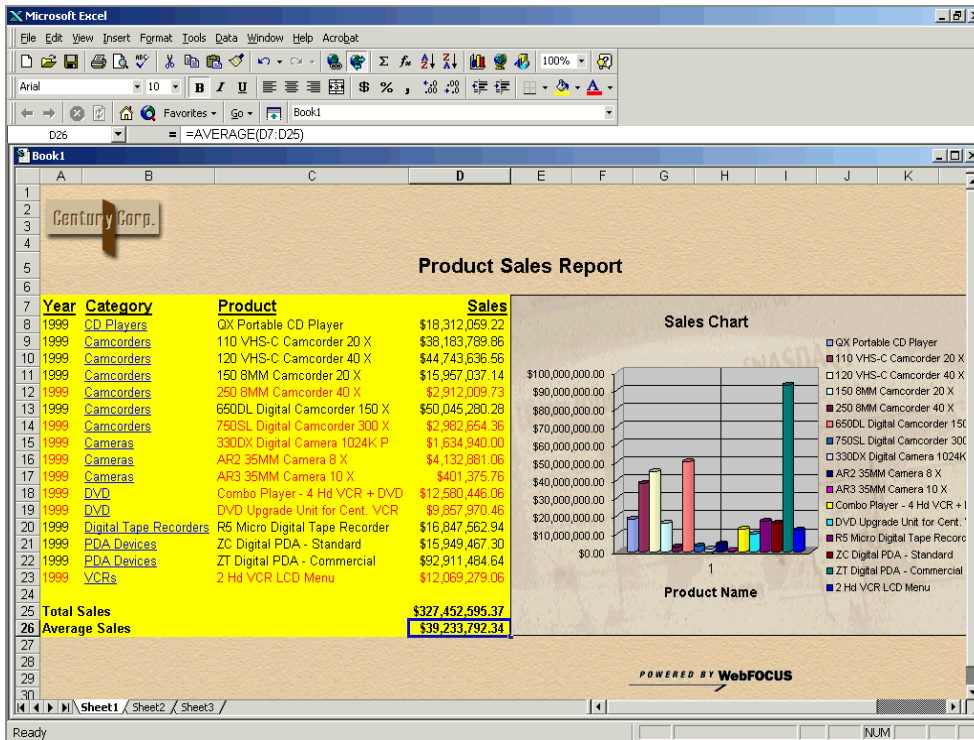

You can now save this spreadsheet locally on your PC, save it to a shared network drive where multiple users can access the information, or deploy it within your web application. See [Using Excel Display Formats: XLSX, EXL2K, EXL97](#).

Deploying a Worksheet With a WebFOCUS Web Query

In both Excel 97 and Excel 2000/2003, you can deploy a customized worksheet containing a WebFOCUS Web Query to the web server and access it via a hyperlink. This technique enables you to deploy an Excel "template" that is pumped with live data each time it is accessed by a user. It is intended to work with Excel 97 versions and higher.

Deploying a Worksheet With a WebFOCUS Web Query to a Web Server

You must create a worksheet and enable the query to be refreshed when the file opens.

Select **Refresh data on file open** under the Refresh Control in the External Data Range Properties dialog box.

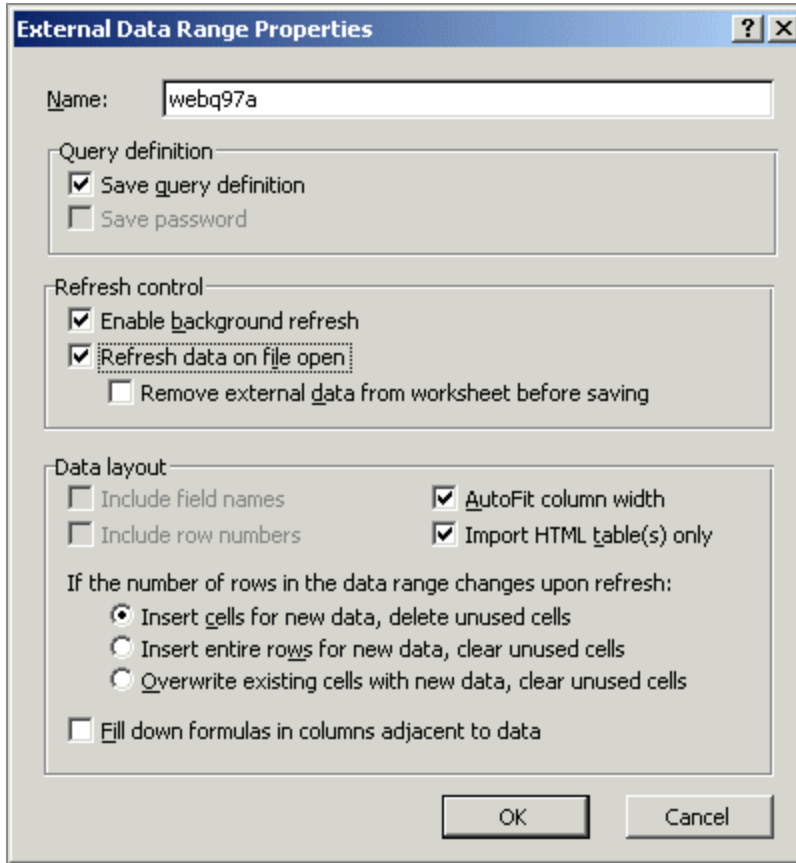

To ensure that the query is embedded in the worksheet, execute the Query and save the worksheet before deploying.

To set up the launch page, create a link that calls the worksheet. For example,

```
<a href=http://server/ibi_html/webq97.xls>Excel Sales Report</a>
```

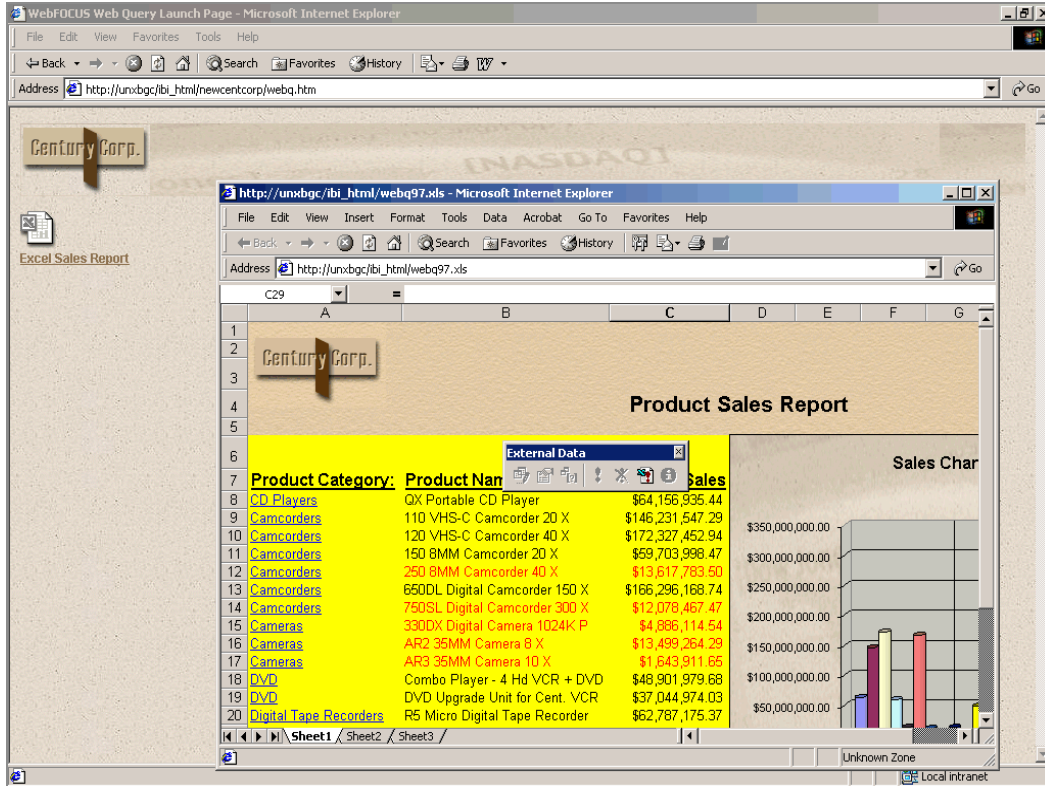
Now, multiple users can benefit from a deployed WebFOCUS/Excel Web Query if running Excel 97 or higher.

Note: To take advantage of this feature, Excel (with Query) needs to be installed on the end-user (client) machine.

Using PowerPoint PPT Display Format

Specifying PowerPoint (PPT) as the output format creates a PowerPoint document with a single slide that includes the report.

You can add multiple graphs and images to a PowerPoint presentation. The PowerPoint output format can contain a variety of graphs positioned anywhere on a slide to create a visual layout.

You can also place report output on a specific slide in a PowerPoint template.

Using PowerPoint PPT Templates

A WebFOCUS report can be placed inside of an existing PowerPoint presentation. This enables you to populate existing presentations with preset Slide Masters, styling, and other business content. PowerPoint PPT templates are stored on the server with a .MHT extension and can be distributed automatically with ReportCaster.

Create PowerPoint PPT Report Output

```
ON TABLE {PCHOLD|HOLD|SAVE} [AS name] FORMAT PPT  
[TEMPLATE 'template' SLIDENUMBER n]
```

where:

name

Is the name of the PowerPoint output file.

template

Is the name of the PowerPoint template file. The template file must have at least one blank slide and must be saved as a Web Archive (.MHT extension) on your WebFOCUS Reporting Server application directory.



Tip: Since the WebFOCUS Reporting Server cannot differentiate between Excel and PowerPoint template files (.MHT), it is important to apply a naming convention to your template files. This will help you organize and distinguish the different Excel and PowerPoint template files when developing your reports. For example, Excel_template.MHT or PPT_template.MHT.

n

Is the number of the slide on which to place the report output. This number is optional if the template has only one slide.

Using a PowerPoint PPT Template

The following request against the GGSALES data source inserts a WebFOCUS report into a PowerPoint template named mytemplate.mht, which is stored in the application directory:

```
TABLE FILE GGSALES
HEADING
" "
" "
" "
" "
" "
" "
SUM DOLLARS UNITS CATEGORY
BY REGION
ON TABLE SET PAGE-NUM NOLEAD
ON TABLE NOTOTAL
ON TABLE PCHOLD FORMAT PPT TEMPLATE 'mytemplate' SLIDENUMBER 1
ON TABLE SET HTMLCSS ON
ON TABLE SET STYLE *
TYPE=REPORT, FONT=ARIAL, SIZE=10,$
TYPE=HEADING, image=gglogo.gif, POSITION=(0.000000 0.000000),$
ENDSTYLE
END
```

The output is:

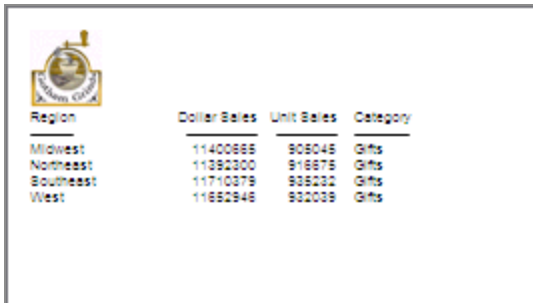

Region	Dollar Sales	Unit Sales	Category
Midwest	11400885	905046	Gifts
Northeast	11392300	918875	Gifts
Southeast	11710379	935232	Gifts
West	11652946	932039	Gifts

Using PowerPoint PPTX Display Format

With PowerPoint (PPTX), Microsoft introduced enhanced functionality in a new presentation file format. The PPTX format is supported in Microsoft Office versions 2007, 2010, and 2013. Earlier versions of PowerPoint can be updated to read the PPTX format

using the Microsoft Office Compatibility Pack available from the Microsoft download site: <http://www.microsoft.com/downloads/en/default.aspx>

Due to security policy changes implemented by Microsoft, the Excel and PowerPoint formats generated by FOCUS (EXL2K and PPT) will no longer be supported by Microsoft Office 2013. In addition, these formats are not supported by Microsoft Excel Viewer and PowerPoint Viewer in any Microsoft Office release. Use FOCUS to generate Excel (XLSX) and PowerPoint (PPTX) reports that can be viewed in these applications.

With FOCUS, you can retrieve data from any FOCUS supported data source and generate a PPTX presentation for data analysis and distribution.

The PPTX format generates fully styled reports in binary display format, which uses the same binary technology that is used for XLSX. When PPTX is specified as the output format, a PowerPoint presentation with a single slide that includes the report is created.

The FOCUS procedure generates a new presentation containing your defined report elements, such as headings and subtotals, as well as StyleSheet syntax, such as conditional styling and drill downs.

Create PowerPoint PPTX Report Output

```
ON TABLE {HOLD|SAVE} [AS name] FORMAT PPTX
```

where:

name

Is the name of the PowerPoint output file.

Using PowerPoint PPTX Templates

You can place report output on a specific slide in a PowerPoint template. This enables you to populate existing presentations with preset Slide Masters, styling, and other business content. PowerPoint design templates (POTX) and PowerPoint macro-enabled templates (POTM) are stored on the server and used to generate individual presentations that can be distributed automatically with ReportCaster.

The following table lists the available presentation template file types and the associated presentation file each will generate.

Template File Type	Output Presentation Generated
Template (.potx)	Presentation (.pptx)
Macro-Enabled Template (.potm)	Macro-Enabled Presentation (.pptm)
Presentation (.pptx)	Presentation (.pptx)
Macro-Enabled Presentation (.pptm)	Macro-Enabled Presentation (.pptm)

Create PowerPoint PPTX Report Output

```
ON TABLE {PCHOLD|HOLD|SAVE} [AS name] FORMAT PPTX
```

where:

name

Is the name of the PowerPoint output file.

Building the .pptx Presentation File

Microsoft changed the format and structure of the PowerPoint (PPTX) presentation. The new .pptx file is a binary compilation of a group of xml files. Generating this new file format using WebFOCUS is a two-step process that consists of generating the xml files containing the report output and zipping the xml documents into the binary .pptx format. The WebFOCUS Reporting Server performs the xml generation process. The zipping process can be completed either by the client (WebFOCUS Servlet) or the server (JSCOM3):

- **WebFOCUS Servlet.** The WebFOCUS Client within the application server performs the zipping process. This can be done within the local client or through a remotely accessed client. The servlet method is the default approach defined for each

WebFOCUS Client, with the client by default pointing to itself.

- **JSCOM3.** The Java layer of the WebFOCUS Reporting Server performs the zipping operation. This option should be used when the WebFOCUS Servlet is configured on a secured web or application server. This is because JSCOM3 does not require URL access to a remote WebFOCUS Client.

Select the Method for Zipping the .pptx File

Designate the method and location where the zipping will occur by setting EXCELSERVURL to a URL (for the WebFOCUS Servlet) or to a blank (for JSCOM3). You can set this value for a specific procedure or for the entire environment:

- **For a procedure.** Issue the SET EXCELSERVURL command within the procedure.
- **For the entire environment.** Edit the IBIF_excelservurl variable in the WebFOCUS Administration Console by selecting:

Configuration/Client Settings/General/IBIF_excelservurl

For more information on accessing the WebFOCUS Administration Console and setting the IBIF_excelservurl variable, see the *WebFOCUS Security and Administration* manual.

The value you assign to EXCELSERVURL determines whether the WebFOCUS Servlet or JSCOM3 performs the zipping operation:

- **Specifying the Servlet.** To specify that the WebFOCUS Servlet should be used, set the EXCELSERVURL parameter or the IBIF_variable to the URL of a WebFOCUS client configuration. For example,

In a procedure:

```
SET EXCELSERVURL = http://servername:8080/ibi_apps
```

In the WebFOCUS Administration Console:

```
IBIF_excelservurl = http://servername:8080/ibi_apps
```

- **Specifying JSCOM3.** To specify that JSCOM3 should be used within the current WebFOCUS Reporting Server, set EXCELSERVURL to a blank or an empty string.

In a procedure:

```
SET EXCELSERVURL = ''
```

In the WebFOCUS Administration Console:

```
IBIF_excelservurl = ''
```

By default, each WebFOCUS Client contains the following URL definition that points to itself:

```
&URL_PROTOCOL://&servername:&server_port&IBIF_webapp
```

Usage Notes for PPTX

- BORDER mode is enabled when BORDER=ON or OFF and/or when other border specifications are added to the report, such as BORDER=HEAVY. A report can display either grids or borders, but these cannot be combined in a report. If a report is in border mode and grids are also enabled, border mode will take precedence over grid functionality, and, where applicable, only borders will be displayed.

Format PPTX Limitations

Format PPTX does not support the following features:

- Bullets and numbering
- Custom font colors on drill-down hyperlinks
- Alignment grid
 - HEADALIGN=BODY
 - Internal borders (BORDERALL=ON)
- BLOB images

Format PPTX does not support the following features, which are supported for PPT:

- Old compound syntax (OPEN/CLOSE)

Handling Records With Missing Field Values

Missing data is defined as data that is missing from a report because it is not relevant or does not exist in the data source. Report output that involves averaging and counting calculations or the display of parent segment instances may be affected by missing data. Data can be missing from reports and calculations for the following reasons:

- Data is not relevant to a particular row and column in a report. See [Irrelevant Report Data](#).
- A field in a segment instance does not have a data value. See [Missing Field Values](#).
- A parent segment instance does not have child instances (missing segment instances). See [Handling a Missing Segment Instance](#).

i Note: To run the examples in this topic, you must run the stored procedures EMPMISS and SALEMISS to add missing data to the EMPLOYEE and SALES data sources, respectively.

Irrelevant Report Data

Data can be missing from a report row or column because it is not relevant. The missing or inapplicable value is indicated by the NODATA default character, a period (.).

✓ Tip: You may specify a more meaningful NODATA value by issuing the SET NODATA command (see [Setting the NODATA Character String](#)).

Irrelevant Report Data

The following request shows how the default NODATA character displays missing data in a report.

```
TABLE FILE EMPLOYEE
PRINT CURR_SAL
BY LAST_NAME
BY FIRST_NAME
ACROSS DEPARTMENT
END
```

The output is:

LAST_NAME	FIRST_NAME	DEPARTMENT	
		MIS	PRODUCTION
BANNING	JOHN	.	\$29,700.00
BLACKWOOD	ROSEMARIE	\$21,780.00	.
CROSS	BARBARA	\$27,062.00	.
DAVIS	ELIZABETH	\$.00	.
GARDNER	DAVID	.	\$.00
GREENSPAN	MARY	\$9,000.00	.
IRVING	JOAN	.	\$26,862.00
JONES	DIANE	\$18,480.00	.
MCCOY	JOHN	\$18,480.00	.
MCKNIGHT	ROGER	.	\$16,100.00
ROMANS	ANTHONY	.	\$21,120.00
SMITH	MARY	\$13,200.00	.
	RICHARD	.	\$9,500.00
STEVENS	ALFRED	.	\$11,000.00

LAST_NAME	FIRST_NAME	DEPARTMENT	
		MIS	PRODUCTION
BANNING	JOHN	.	\$29,700.00
BLACKWOOD	ROSEMARIE	\$21,780.00	.
CROSS	BARBARA	\$27,062.00	.
GREENSPAN	MARY	\$9,000.00	.
IRVING	JOAN	.	\$26,862.00
JONES	DIANE	\$18,480.00	.
MCCOY	JOHN	\$18,480.00	.
MCKNIGHT	ROGER	.	\$16,100.00
ROMANS	ANTHONY	.	\$21,120.00
SMITH	MARY	\$13,200.00	.
	RICHARD	.	\$9,050.00
STEVENS	ALFRED	.	\$11,000.00

The salary for an employee working in the production department displays in the PRODUCTION column. The salary for an employee working in the MIS department displays in the MIS column. The corresponding value in the PRODUCTION or MIS column,

respectively, is missing because the salary displays only under the department where the person is employed.

Missing Field Values

Missing values within segment instances occur when the instances exist, but some of the fields lack values.

When fields in instances lack values, numeric fields are assigned the value 0, and alphanumeric fields, the value blank. These default values appear in reports and are used in all calculations performed by the SUM and COUNT display commands, DEFINE commands, and prefix operators such as MAX. and AVE.

To prevent the use of these default values in calculations (which might then give erroneous results), you can add the MISSING attribute to the field declaration in the Master File, for either a real or a virtual field. When the MISSING attribute is set to ON, the missing values are marked with a special internal code to distinguish them from blanks or zeros, and the missing values are ignored in calculations. In reports, the internal code is represented by the SET NODATA value, a period (.), by default. See [Setting the NODATA Character String](#).

For example, missing data for a field in a segment instance may occur when the data values are unknown, as in the following scenario. Suppose that the employees recorded in the EMPLOYEE data source are due for a pay raise by a certain date, but the amount of the raise has not yet been determined. The company enters the date for each employee into the data source without the salary amounts; the salaries will be entered later. Each date is an individual instance in the salary history segment, but the new salary for each date instance is missing. Suppose further that a report request averages the SALARY field (SUM AVE.SALARY). The accuracy of the resulting average depends on whether the missing values for the SALARY field are treated as zeros (MISSING=OFF), or as internal codes (MISSING=ON).

i Note: When all of the field values used in the calculation of a numeric summary value, such as a subtotal, are missing, the summary value is assigned the missing data value, *not* the value zero (0). This includes summary values produced by the operators ST. and CT. used in a subfooting.

Counting With Missing Values

Suppose the CURR_SAL field appears in 12 segment instances. In three of those instances, the field was given no value. Nevertheless, the display command

```
COUNT CURR_SAL
```

counts 12 occurrences of the CURR_SAL field. This occurs because the MISSING attribute is OFF by default, so the missing values are included in the count. If you want to exclude the missing data from the count, you can set MISSING ON.

Averaging With Missing Values

Suppose you have the following records of data for a field:

```
.  
.   
1  
3
```

The numeric values in the first two records are missing (indicated by the periods). The last two records have values of 1 and 3. If you average these fields without the MISSING attribute (MISSING OFF), the value 0 is supplied for the two records that are missing values. Thus, the average of the records is $(0+0+1+3)/4$, or 1. If you use the MISSING ON attribute, the two missing values are ignored, calculating the average as $(1+3)/2$, or 2.

MISSING Attribute in the Master File

In some applications, the default values (blanks and zeros) may represent valid data rather than the absence of information. However, if this is *not* the case, you can include the MISSING attribute after the field format in the Master File declaration for the field with the missing values. The MISSING attribute can be used with an actual field in the data source, or a virtual field that you are defining in the Master File.

For example, the following field declaration specifies the MISSING attribute for the RETURNS field:

```
FIELDNAME=RETURNS, ALIAS=RTN, FORMAT=I4, MISSING=ON,$
```

The next declaration specifies the MISSING attribute for a virtual field called PROFIT:

```
DEFINE PROFIT/D7 MISSING ON NEEDS SOME DATA = RETAIL_COST - DEALER_
COST;$
```

To ensure that missing values are handled properly for virtual fields, you can set the MISSING attribute ON for the virtual field in the DEFINE command, and specify whether you want to apply the calculation if some or all values are missing. For related information on the SOME and ALL phrases, see [Specify Missing Values in a DEFINE or COMPUTE Command](#).

When the MISSING attribute is set to ON in a field declaration, the field containing no data is marked with a special internal code, rather than with blanks or zeros. During report generation, the SUM and COUNT commands and all prefix operators (for example, AVE., MAX., MIN.) exclude the missing data in their computations. For related information about the MISSING attribute and field declarations, see the *ibi™ FOCUS® Describing Data* manual.



Note:

- You may add MISSING field attributes to the Master File at any time. However, MISSING attributes only affect data entered into the data source after the attributes were added.
- Key fields are needed to identify a record. Therefore, key fields should not be identified as missing.

Handling Missing Values With the MISSING Attribute

This example illustrates the difference between a field with MISSING ON and one without. In it a virtual field, X_RETURNS, without the MISSING attribute, is set to equal a real field, RETURNS, with the MISSING attribute declared in the Master File. When the field with the MISSING attribute (RETURNS) is missing a value, the corresponding value of X_RETURNS is 0, since a data source field that is missing a value is evaluated as 0 (or blank) for the purpose of computation (see [MISSING Attribute in a DEFINE or COMPUTE Command](#)).

The following request defines the virtual field:

```
DEFINE FILE SALES
X_RETURNS/I4 = RETURNS;
END
```

Now issue the following report request:

```
TABLE FILE SALES
SUM CNT.X_RETURNS CNT.RETURNS AVE.X_RETURNS AVE.RETURNS
END
```

Remember that the field X_RETURNS has the same value as RETURNS except when RETURNS is missing a value, in which case, the X_RETURNS value is 0.

The output is:

X_RETURNS COUNT	RETURNS COUNT	AVE X_RETURNS	AVE RETURNS
22	20	2	3

X_RETURNS COUNT	RETURNS COUNT	AVE X_RETURNS	AVE RETURNS
22	20	2	3

The count for the RETURNS field is lower than the count for X_RETURNS and the average for RETURNS is higher than for X_RETURNS because the missing values in RETURNS are not part of the calculations.

MISSING Attribute in a DEFINE or COMPUTE Command

You can set the MISSING attribute ON in a DEFINE or COMPUTE command to enable a temporary field with missing values to be interpreted and represented correctly in reports.

An expression used to derive the values of the temporary field can contain real fields that have missing values. However, when used to derive the value of a temporary field, a data source field that is missing a value is evaluated as 0 or blank for computational purposes, even if the MISSING attribute has been set to ON for that field in the Master File.

To ensure that missing values are handled properly for temporary fields, you can set the MISSING attribute ON for the virtual field in the DEFINE or COMPUTE command, and specify whether you want to apply the calculation if some or all values are missing. See [Specify Missing Values in a DEFINE or COMPUTE Command](#).

Specify Missing Values in a DEFINE or COMPUTE Command

```
field[/format] MISSING {ON|OFF} [NEEDS] {SOME|ALL} [DATA] = expression;
```

where:

field

Is the name of the virtual field created by the DEFINE command.

/format

Is the format of the virtual field. The default is D12.2.

MISSING

ON enables the value of the temporary field to be interpreted as missing (that is, distinguished by the special internal code from an intentionally entered zero or blank), and represented by the NODATA character in reports.

OFF treats missing values for numeric fields as zeros, and missing values for alphanumeric fields as blanks. This is the default value.

NEEDS

Is optional. It helps to clarify the meaning of the command.

SOME

Indicates that if at least one field in the expression has a value, the temporary field has a value (the missing values of the field are evaluated as 0 or blank in the calculation). If all of the fields in the expression are missing values, the temporary field is missing its value. SOME is the default value.

ALL

Indicates that if all the fields in the expression have values, the temporary field has a value. If at least one field in the expression has a missing value, the temporary field also has a missing value.

DATA

Is optional. It helps to clarify the meaning of the command.

expression

Is a valid expression from which the temporary field derives its value.



Note: You can also use the SET MISS_ON command to set a default value for MISSING ON in DEFINE and COMPUTE.

Handling Missing Values for a Virtual Field With MISSING OFF

The following request illustrates the use of two fields, RETURNS and DAMAGED, to define the NO_SALE field. Both the RETURNS and DAMAGED fields have the MISSING attribute set to ON in the SALES Master File, yet whenever one of these fields is missing a value, that field is evaluated as 0.

```
DEFINE FILE SALES
NO_SALE/I4 = RETURNS + DAMAGED;
END
TABLE FILE SALES
PRINT RETURNS AND DAMAGED AND NO_SALE
BY CITY BY DATE BY PROD_CODE
END
```

The output is:

CITY	DATE	PROD_CODE	RETURNS	DAMAGED	NO_SALE
----	----	-----	-----	-----	-----
NEW YORK	10/17	B10	2	3	5
		B17	2	1	3
		B20	0	1	1

		C13	.	6	6
		C14	4	.	4
		C17	0	0	0
		D12	3	2	5
		E1	4	7	11
		E2	.	.	0
		E3	4	2	6
NEWARK	10/18	B10	1	1	2
	10/19	B12	1	0	1
STAMFORD	12/12	B10	10	6	16
		B12	3	3	6
		B17	2	1	3
		C13	3	0	3
		C7	5	4	9
		D12	0	0	0
		E2	9	4	13
		E3	8	9	17
UNIONDALE	10/18	B20	1	1	2
		C7	0	0	0

Notice that the products C13, C14, and E2 in the New York section all show missing values for either RETURNS or DAMAGED, because the MISSING ON attribute has been set in the Master File. However, the calculation that determines the value of NO_SALE interprets these missing values as zeros, because MISSING ON has not been set for the virtual field.

Handling Missing Values for Virtual Fields With SOME and ALL

The following request illustrates how to use the DEFINE command with the MISSING attribute to specify that if either some or all of the field values referenced in a DEFINE command are missing, the virtual field should also be missing its value.

The SOMEDATA field contains a value if either the RETURNS or DAMAGED field contains a value. Otherwise, SOMEDATA is missing its value. The ALLDATA field contains a value only if both the RETURNS and DAMAGED fields contain values. Otherwise, ALLDATA is missing its value.

```
DEFINE FILE SALES
SOMEDATA/I5 MISSING ON NEEDS SOME=RETURNS + DAMAGED;
ALLDATA/I5 MISSING ON NEEDS ALL=RETURNS + DAMAGED;
END
```



```
TABLE FILE SALES
PRINT RETURNS AND DAMAGED SOMEDATA ALLDATA
BY CITY BY DATE BY PROD_CODE
END
```

The output is:

CITY	DATE	PROD_CODE	RETURNS	DAMAGED	SOMEDATA	ALLDATA
----	----	-----	-----	-----	-----	-----
NEW YORK	10/17	B10	2	3	5	5
		B17	2	1	3	3
		B20	0	1	1	1
		C13	.	6	6	.
		C14	4	.	4	.
		C17	0	0	0	0
		D12	3	2	5	5
		E1	4	7	11	11
		E2
		E3	4	2	6	6
NEWARK	10/18	B10	1	1	2	2
	10/19	B12	1	0	1	1
STAMFORD	12/12	B10	10	6	16	16
		B12	3	3	6	6
		B17	2	1	3	3
		C13	3	0	3	3
		C7	5	4	9	9
		D12	0	0	0	0
		E2	9	4	13	13
E3	8	9	17	17		
UNIONDALE	10/18	B20	1	1	2	2
		C7	0	0	0	0

CITY	DATE	PROD_CODE	RETURNS	DAMAGED	SOMEDATA	ALLDATA
NEW YORK	10/17	B10	2	3	5	5
		B17	2	1	3	3
		B20	0	1	1	1
		C13	.	6	6	.
		C14	4	.	4	.
		C17	0	0	0	0
		D12	3	2	5	5
		E1	4	7	11	11
		E2
		E3	4	2	6	6
NEWARK	10/18	B10	1	1	2	2
	10/19	B12	1	0	1	1
STAMFORD	12/12	B10	10	6	16	16
		B12	3	3	6	6
		B17	2	1	3	3
		C13	3	0	3	3
		C7	5	4	9	9
		D12	0	0	0	0
		E2	9	4	13	13
		E3	8	9	17	17
UNIONDALE	10/18	B20	1	1	2	2
		C7	0	0	0	0

Setting MISSING ON Behavior for DEFINE and COMPUTE

When a virtual field or calculated value can have missing values, you can specify whether all or some of the field values used in the expression that creates the DEFINE or COMPUTE field must be missing to make the result field missing. If you do not specify ALL or SOME for a DEFINE or COMPUTE with MISSING ON, the default value is SOME.

The SET parameter MISS_ON enables you to specify whether SOME or ALL should be used for MISSING ON in a DEFINE or COMPUTE that does not specify which to use.

```
SET MISS_ON = {SOME|ALL}
```

where:

SOME

Indicates that if at least one field in the expression has a value, the temporary field has a value (the missing values of the field are evaluated as 0 or blank in the calculation). If all of the fields in the expression are missing values, the temporary field has a missing value. SOME is the default value.

ALL

Indicates that if all the fields in the expression have values, the temporary field has a value. If at least one field in the expression has a missing value, the temporary field has a missing value.

Setting a Default Value for MISSING ON in DEFINE and COMPUTE

The following request creates three virtual fields that all have MISSING ON. Field AAA has all missing values. Field BBB is missing only when the category is Gifts and has the value 100 otherwise. Field CCC is the sum of AAA and BBB.

```
SET MISS_ON = SOME
DEFINE FILE GGSales
AAA/D20 MISSING ON = MISSING;
BBB/D20 MISSING ON = IF CATEGORY EQ 'Gifts' THEN MISSING ELSE 100;
CCC/D20 MISSING ON = AAA + BBB;
END
TABLE FILE GGSales
SUM
AAA
BBB
CCC
BY CATEGORY
ON TABLE SET PAGE NOLEAD
ON TABLE SET STYLE *
GRID=OFF,$
END
```

Running the request with SET MISS_ON=SOME (the default) shows that CCC has a value unless both AAA and BBB are missing.

<u>Category</u>	<u>AAA</u>	<u>BBB</u>	<u>CCC</u>
Coffee	.	144,000	144,000
Food	.	144,000	144,000
Gifts	.	.	.

Changing SET MISS_ON to ALL, produces the following output. CCC is assigned a missing value because one of the fields used to calculate it is always missing.

<u>Category</u>	<u>AAA</u>	<u>BBB</u>	<u>CCC</u>
Coffee	.	144,000	.
Food	.	144,000	.
Gifts	.	.	.

Testing for Missing Values in IF-THEN-ELSE Expressions

In order to optimize the efficiency of IF-THEN-ELSE expression processing, the entire expression may not be parsed when the result (true or false) can be determined without parsing the entire expression. For example, consider the following IF-THEN-ELSE expression.

```
COMPUTE CCC/D9.1 MISSING ON = IF AAA EQ 0 OR BBB EQ 0 THEN 0 ELSE AAA /
BBB * 100;
```



Note:

- AAA is a missable field (MISSING ON) that is set to MISSING.
- BBB is a field with MISSING ON that is set to 100, so it has a value that is not MISSING.

For evaluation in expressions, a field that is MISSING is treated as zero (0).

CCC is a numeric field that has MISSING ON computed using an IF-THEN-ELSE expression. The IF clause contains two tests connected by the OR operator. If either one of these two tests is TRUE, the value in the THEN clause will be passed to the final MISSING check. If neither is TRUE, the value in the ELSE clause will be passed to the MISSING check.

In this case, AAA EQ 0 is true (since MISSING is treated as 0 when used in a comparison). So the THEN value, which is zero, is accepted. Since CCC has MISSING ON, which defaults to NEEDS SOME values, at least one data value evaluated in the IF clause must *not* be missing.

Only AAA was evaluated to get the TRUE condition. BBB was not tested and, therefore, is not included in the fields that are checked for missing values. Since AAA is MISSING, CCC (since it NEEDS SOME and does not have any) must be set to MISSING. Note that this

processing represents a change from the processing in prior releases and, while it increases processing efficiency, it may produce different results.

Since the test for a value and the test for existence or presence (MISSING) are not the same, the best practice is always to use the test that is appropriate. When testing for MISSING, using IS MISSING is preferred to using EQ 0, as it is more direct and does not result in the same behavior change from previous releases.

Consider the following request. CCC uses EQ 0 in the IF-THEN-ELSE test, and DDD uses IS MISSING.

```

DEFINE FILE GGSales
AAA/D20 MISSING ON = MISSING;
BBB/D20 MISSING ON = 100;
END
TABLE FILE GGSales
SUM
  AAA
  BBB
  COMPUTE CCC/D9.1 MISSING ON = IF AAA EQ 0 OR BBB EQ 0 THEN 0 ELSE AAA
  / BBB * 100;
  COMPUTE DDD/D9.1 MISSING ON = IF AAA IS MISSING OR BBB IS MISSING THEN
  0 ELSE AAA / BBB * 100;
BY CATEGORY
ON TABLE SET PAGE NOLEAD
ON TABLE SET STYLE *
GRID=OFF,$
END

```

The output is shown in the following image. While CCC evaluates to a missing value, DDD evaluates to 0 because both the AAA and BBB were evaluated to get the TRUE condition and BBB is not missing, satisfying the NEEDS SOME VALUES definition for DDD.

<u>Category</u>	<u>AAA</u>	<u>BBB</u>	<u>CCC</u>	<u>DDD</u>
Coffee	.	144,000	.	.0
Food	.	144,000	.	.0
Gifts	.	143,700	.	.0

Using SET MISSINGTEST With IF-THEN-ELSE Expressions

In prior releases, by default, when an IF-THEN-ELSE expression was used to calculate a result and the IF expression evaluated to zero (for numeric expressions) or blank (for alphanumeric expressions), the left-hand side was checked to see if it had MISSING ON. If it did, and only some values were needed (NEEDS SOME), the result of the IF expression was MISSING, not true or false. The outcome returned was also MISSING, not the result of evaluating the THEN or ELSE expression. The SET MISSINGTEST = NEW command eliminates the missing test for the IF expression so that either the THEN expression or the ELSE expression will be evaluated and returned as the result. This is the default behavior.

The syntax is:

```
SET MISSINGTEST = {NEW|OLD|SPECIAL}
```

where:

NEW

Excludes the IF expression from the missing values evaluation so that the IF expression results in either true or false, not MISSING. If it evaluates to true, the THEN expression is used to calculate the result. If it evaluates to false, the ELSE expression is used to calculate the result. This is the default value.

OLD

Includes the IF expression in the missing values evaluation. If the IF expression evaluates to MISSING and the missing field only needs some missing values, the result is also MISSING.

SPECIAL

Is required for passing parameters to RStat.

Using SET MISSINGTEST With IF-THEN-ELSE Expressions

The following request defines a field named MISS_FIELD that contains a missing value for the country name Austria. In the TABLE request there are two calculated values, CALC1 and CALC2 that test this field in IF-THEN-ELSE expressions. Both of these fields have MISSING ON and need only some missing values to be missing:

```

SET MISSINGTEST = OLD
DEFINE FILE WFLITE
MISS_FIELD/A10 MISSING ON = IF COUNTRY_NAME NE 'Austria' THEN
'DATAEXISTS' ELSE MISSING;
END

TABLE FILE WFLITE
SUM COGS_US MISS_FIELD
COMPUTE CALC1/A7 MISSING ON = IF ((MISS_FIELD EQ '') OR (MISS_FIELD EQ
MISSING)) THEN 'THEN' ELSE 'ELSE';
COMPUTE CALC2/A7 MISSING ON = IF ((MISS_FIELD EQ MISSING) OR (MISS_FIELD
EQ '')) THEN 'THEN' ELSE 'ELSE';
BY COUNTRY_NAME
WHERE BUSINESS_REGION EQ 'EMEA'
WHERE COUNTRY_NAME LT 'E'
ON TABLE SET NODATA 'MISSING'
ON TABLE SET PAGE NOLEAD
ON TABLE SET STYLE *
GRID=OFF,$
ENDSTYLE
END

```

Running the request with MISSINGTEST=OLD produces the output shown in the following image:

<u>Customer</u>				
<u>Country</u>	<u>Cost of Goods</u>	<u>MISS FIELD</u>	<u>CALC1</u>	<u>CALC2</u>
Austria	\$426,570.00	MISSING	MISSING	THEN
Belgium	\$3,800.00	DATAEXISTS	ELSE	ELSE
China	\$563.00	DATAEXISTS	ELSE	ELSE
Denmark	\$1,346.00	DATAEXISTS	ELSE	ELSE

Note that for Austria, MISS_FIELD is MISSING.

- In CALC1, the expression `MISS_FIELD EQ ' '` is evaluated to true. `MISS_FIELD IS MISSING` is not evaluated at all because evaluation stops when it can be determined that the result of the expression is true. However, since the expression compared the field to blank, it is checked to see if the result field supports missing values. Since it does, the final result is `MISSING`.
- In CALC2, the expression `MISS_FIELD EQ MISSING` is true. `MISS_FIELD EQ ' '` is not evaluated at all because evaluation stops when it can be determined that the result of the expression is true. No missing check is needed, so the result of the `IF` expression is `TRUE`, and the `THEN` expression is evaluated and returned as the result.

Changing the `SET` command to `SET MISSINGTEST=NEW` and rerunning the request produces the output shown in the following image. The `IF` expressions in `CALC1` and `CALC2` both evaluate to true because neither expression is checked to see if the result field supports missing, so the `THEN` expression is evaluated and returned as the result in both cases.

Customer				
<u>Country</u>	<u>Cost of Goods</u>	<u>MISS FIELD</u>	<u>CALC1</u>	<u>CALC2</u>
Austria	\$426,570.00	MISSING	THEN	THEN
Belgium	\$3,800.00	DATAEXISTS	ELSE	ELSE
China	\$563.00	DATAEXISTS	ELSE	ELSE
Denmark	\$1,346.00	DATAEXISTS	ELSE	ELSE

Testing for a Segment With a Missing Field Value

You can specify `WHERE` criteria to identify segment instances with missing field values.

You cannot use these tests to identify missing instances. See [Handling a Missing Segment Instance](#).

Test for a Segment With a Missing Field Value

To test for a segment with missing field values, the syntax is:

```
WHERE field {IS|EQ} MISSING
```

To test for the presence of field values, the syntax is:

```
WHERE field {NE|IS-NOT} MISSING
```

A WHERE criterion that tests a numeric field for 0 or an alphanumeric field for blanks also retrieves instances for which the field has a missing value.

Testing for a Missing Field Value

The following request illustrates the use of MISSING to display grocery items (by code) for which the number of packages returned by customers is missing.

```
TABLE FILE SALES
PRINT RETURNS
BY CITY BY DATE BY PROD_CODE
WHERE RETURNS IS MISSING
END
```

The output is:

CITY	DATE	PROD_CODE	RETURNS
----	----	-----	-----
NEW YORK	10/17	C13	.
		E2	.

Testing for an Existing Field Value

The following request illustrates the use of MISSING to display only those grocery items for which the number of packages returned by customers is not missing.

```
TABLE FILE SALES
PRINT RETURNS
BY CITY BY DATE BY PROD_CODE
WHERE RETURNS IS-NOT MISSING
END
```

The output is:

CITY	DATE	PROD_CODE	RETURNS
----	----	-----	-----
NEW YORK	10/17	B10	2
		B17	2
		B20	0
		C14	4
		C17	0
		D12	3
		E1	4
		E3	4
NEWARK	10/18	B10	1
	10/19	B12	1
STAMFORD	12/12	B10	10
		B12	3
		B17	2
		C13	3
		C7	5
		D12	0
		E2	9
		E3	8
UNIONDALE	10/18	B20	1
		C7	0

CITY	DATE	PROD_CODE	RETURNS
NEW YORK	10/17	B10	2
		B17	2
		B20	0
		C14	4
		C17	0
		D12	3
		E1	4
		E3	4
NEWARK	10/18	B10	1
	10/19	B12	1
STAMFORD	12/12	B10	10
		B12	3
		B17	2
		C13	3
		C7	5
		D12	0
		E2	9
		E3	8
UNIONDALE	10/18	B20	1
		C7	0

Testing for a Blank or Zero

The following request displays grocery items that either were never returned or for which the number of returned packages was never recorded:

```
TABLE FILE SALES
PRINT RETURNS
BY CITY BY DATE BY PROD_CODE
WHERE RETURNS EQ 0
END
```

The output is:

CITY	DATE	PROD_CODE	RETURNS
----	----	-----	-----
NEW YORK	10/17	B20	0
		C13	.
		C17	0
		E2	.
STAMFORD	12/12	D12	0
UNIONDALE	10/18	C7	0

CITY	DATE	PROD_CODE	RETURNS
NEW YORK	10/17	B20	0
		C13	.
		C17	0
		E2	.
STAMFORD	12/12	D12	0
UNIONDALE	10/18	C7	0

Excluding Missing Values From a Test

To display only those items that have not been returned by customers, you need two WHERE criteria. The first to restrict the number of returns to 0, the other to exclude missing values, as in the following request.

```
TABLE FILE SALES
PRINT RETURNS
BY CITY BY DATE BY PROD_CODE
WHERE RETURNS EQ 0
WHERE RETURNS IS-NOT MISSING
END
```

The output is:

CITY	DATE	PROD_CODE	RETURNS
----	----	-----	-----
NEW YORK	10/17	B20	0
		C17	0
STAMFORD	12/12	D12	0
UNIONDALE	10/18	C7	0

CITY	DATE	PROD_CODE	RETURNS
NEW YORK	10/17	B20	0
		C17	0
STAMFORD	12/12	D12	0
UNIONDALE	10/18	C7	0

Preserving Missing Data Values in an Output File

The ability to distinguish between missing data and default values (blanks and zeros) in fields can be carried over into output files. If the retrieved and processed information displayed the NODATA string in a report, by default the NODATA string can be stored in the output file. Using the SET HNODATA command, you can change the NODATA value used for alphanumeric output files. You can also use the SET HOLDMISS command to store the missing values rather than the NODATA character in an output file. For related information, see [Saving and Reusing Your Report Output](#).

Distinguish Missing Data in an Extract File

```
ON TABLE {HOLD|SAVE|SAVB} MISSING {ON|OFF}
```

where:

HOLD

Creates an extract file for use in subsequent reports. The default for MISSING is ON.

SAVE

Creates a text extract file for use in other programs. The default for MISSING is OFF.

SAVB

Creates a binary extract file for use in other programs. The default for MISSING is OFF.

HOLD files can be created with both the MISSING and FORMAT ALPHA options, specified in any order. For example:

```
ON TABLE HOLD FORMAT ALPHA MISSING OFF
ON TABLE HOLD MISSING OFF FORMAT ALPHA
```

Incorporating MISSING Values in an Extract File

The following request specifies MISSING ON in the HOLD phrase:

```
TABLE FILE SALES
SUM RETURNS AND HOLD FORMAT ALPHA MISSING ON
BY CITY BY DATE BY PROD_CODE
END
```

The MISSING=ON attribute for the RETURNS field is propagated to the HOLD Master File. In addition, the missing data symbols are propagated to the HOLD file for the missing field values:

```
FILENAME=HOLD      , SUFFIX=FIX      , $
SEGMENT=HOLD, SEGTYPE=S3, $
  FIELDNAME=CITY, ALIAS=E01, USAGE=A15, ACTUAL=A15, $
  FIELDNAME=DATE, ALIAS=E02, USAGE=A4MD, ACTUAL=A04, $
  FIELDNAME=PROD_CODE, ALIAS=E03, USAGE=A3, ACTUAL=A03, $
  FIELDNAME=RETURNS, ALIAS=E04, USAGE=I3, ACTUAL=A03,
  MISSING=ON, $
```

With MISSING OFF in the HOLD phrase, the MISSING=ON attribute is not propagated to the HOLD Master File and the missing data symbols are replaced with default values.

Store Missing Data in HOLD Files

```
SET HOLDMISS={ON|OFF}  
ON TABLE SET HOLDMISS {ON|OFF}
```

where:

ON

Allows you to store missing data in a HOLD file. When TABLE generates a default value for data not found, it generates missing values.

OFF

Does not allow you to store missing data in a HOLD file. OFF is the default value.

Usage Notes for Holding Missing Values

- Setting HOLDMISS ON adds the MISSING=ON attribute to every field in the extract file.
- Data is not found if:
 - ALL is set to ON.
 - The request is multi-path.
 - An ACROSS statement has been issued.

Holding Missing Values Using HOLDMISS

```
SET HOLDMISS=ON  
TABLE FILE MOVIES  
  SUM WHOLESALPR  
  BY CATEGORY ACROSS RATING  
  ON TABLE HOLD AS HLDM  
END  
TABLE FILE HLDM
```

```
PRINT *
END
```

The output is:

CATEGORY	WHOLESALEPR	WHOLESALEPR	WHOLESALEPR	WHOLESALEPR
-----	-----	-----	-----	-----
-				
ACTION	.	.	20.98	.
34.48				
CHILDREN	54.49	51.38	.	.
.				
CLASSIC	40.99	160.80	.	.
.				
COMEDY	.	.	46.70	30.00
13.75				
DRAMA
10.00				
FOREIGN	13.25	.	62.00	.
70.99				
MUSICALS	15.00	.	13.99	9.99
13.99				
MYSTERY	.	9.00	18.00	9.00
80.97				
SCI/FI	.	.	.	35.99
43.53				
TRAIN/EX	.	60.98	.	.
.				

Propagating Missing Values to Reformatted Fields in a Request

When a field is reformatted in a request (for example, SUM field/format), an internal COMPUTE field is created to contain the reformatted field value and display on the report output. If the original field has a missing value, that missing value can be propagated to the internal field by setting the COMPMISS parameter ON. If the missing value is not propagated to the internal field, it displays a zero (if it is numeric) or a blank (if it is alphanumeric). If the missing value is propagated to the internal field, it displays the missing data symbol on the report output.

Control Missing Values in Reformatted Fields

```
SET COMPMISS = {ON|OFF}
```

where:

ON

Propagates a missing value to a reformatted field.

OFF

Displays a blank or zero for a reformatted field. OFF is the default value.

Note: The COMPMISS parameter cannot be set in an ON TABLE command.

Controlling Missing Values in Reformatted Fields

The following procedure prints the RETURNS field from the SALES data source for store 14Z. With COMPMISS OFF, the missing values display as zeros in the column for the reformatted field value.

Note: Before trying this example, you must make sure that the SALEMIS procedure, which adds missing values to the SALES data source, has been run.

```
SET COMPMISS = OFF
TABLE FILE SALES
PRINT RETURNS RETURNS/D12.2 AS 'REFORMATTED, RETURNS'
BY STORE_CODE
WHERE STORE_CODE EQ '14Z'
END
```

The output is:

STORE_CODE	RETURNS	REFORMATTED RETURNS
-----	-----	-----
14Z	2	2.00

```

      2          2.00
      0          .00
      .          .00
      4          4.00
      0          .00
      3          3.00
      4          4.00
      .          .00
      4          4.00

```

With `COMPMISS ON`, the column for the reformatted version of `RETURNS` displays the missing data symbol when a value is missing:

```

SET COMPMISS = ON
TABLE FILE SALES
PRINT RETURNS RETURNS/D12.2 AS 'REFORMATTED,RETURNS'
BY STORE_CODE
WHERE STORE_CODE EQ '14Z'
END

```

The output is:

STORE_CODE	RETURNS	REFORMATTED RETURNS
-----	-----	-----
14Z	2	2.00
	2	2.00
	0	.00
	.	.
	4	4.00
	0	.00
	3	3.00
	4	4.00
	.	.
	4	4.00

Usage Notes for SET COMPMISS

If you create a HOLD file with `COMPMISS ON`, the HOLD Master File for the reformatted field indicates `MISSING = ON` (as does the original field). With `COMPMISS = OFF`, the reformatted field does NOT have `MISSING = ON` in the generated Master File.

Handling a Missing Segment Instance

In multi-segment data sources, when an instance in a parent segment does not have descendant instances, the nonexistent descendant instances are called missing instances.

When you write a request from a data source that has missing segment instances, the missing instances affect the report. For example, if the request names fields in a segment and its descendants, the report omits parent segment instances that have no descendants. It makes no difference whether fields are display fields or sort fields.

When an instance is missing descendants in a child segment, the instance, its parent, the parent of its parent, and so on up to the root segment, is called a short path. Unique segments are never considered to be missing.

For example, consider the following subset of the EMPLOYEE data source.

- The top segment contains employee names.
- The left segment contains addresses.
- The right segment contains the salary history of each employee: the date the employee was granted a new salary, and the amount of the salary.

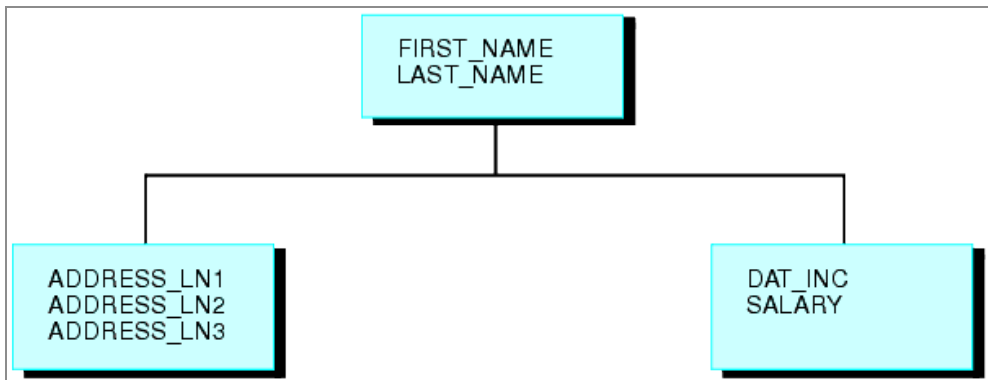

Suppose some employees are paid by an outside agency. None of these employees have a company salary history. Instances referring to these employees in the salary history segment are missing.

Nonexistent descendant instances affect whether parent segment instances are included in report results. The SET ALL parameter and the ALL. prefix enable you to include parent segment data in reports.

For illustrations of how missing segment instances impact reporting, see [Reporting Against Segments Without Descendant Instances](#) and [Reporting Against Segments With Descendant Instances](#).

Reporting Against Segments Without Descendant Instances

The following request displays the salary histories for each employee.

```
TABLE FILE EMPLOYEE
PRINT SALARY
BY LAST_NAME BY FIRST_NAME
BY DAT_INC
END
```

However, two employees, Davis and Gardner, are omitted from the following report because the LAST_NAME and FIRST_NAME fields belong to the root segment, and the DAT_INC and SALARY fields belong to the descendant salary history segment. Since Davis and Gardner have no descendant instances in the salary history segment, they are omitted from the report.

The output is:

LAST_NAME	FIRST_NAME	DAT_INC	SALARY
-----	-----	-----	-----
BANNING	JOHN	82/08/01	\$29,700.00
BLACKWOOD	ROSEMARIE	82/04/01	\$21,780.00
CROSS	BARBARA	81/11/02	\$25,775.00
		82/04/09	\$27,062.00
GREENSPAN	MARY	82/04/01	\$8,650.00
		82/06/11	\$9,000.00
IRVING	JOAN	82/01/04	\$24,420.00
		82/05/14	\$26,862.00
JONES	DIANE	82/05/01	\$17,750.00
		82/06/01	\$18,480.00
MCCOY	JOHN	82/01/01	\$18,480.00
MCKNIGHT	ROGER	82/02/02	\$15,000.00
		82/05/14	\$16,100.00
ROMANS	ANTHONY	82/07/01	\$21,120.00
SMITH	MARY	82/01/01	\$13,200.00
	RICHARD	82/01/04	\$9,050.00
		82/05/14	\$9,500.00
STEVENS	ALFRED	81/01/01	\$10,000.00
		82/01/01	\$11,000.00

Reporting Against Segments With Descendant Instances

The following request displays the average salary and second address line of each employee. The data source contains Davis' address, but not Gardner's.

```
TABLE FILE EMPLOYEE
SUM AVE.SALARY
AND ADDRESS_LN2
BY LAST_NAME BY FIRST_NAME
END
```

This report displays Davis' name even though Davis has no salary history, because Davis has an instance in the descendant address segment. The report omits Gardner entirely, because Gardner has neither a salary history nor an address.

The output is:

LAST_NAME	FIRST_NAME	SALARY	ADDRESS_LN2
-----	-----	-----	-----
BANNING	JOHN	\$29,700.00	APT 4C
BLACKWOOD	ROSEMARIE	\$21,780.00	3704 FARRAGUT RD.
CROSS	BARBARA	\$26,418.50	147-15 NORTHERN BLD
DAVIS	ELIZABETH	.	2530 AMSTERDAM AVE.
GREENSPAN	MARY	\$8,825.00	13 LINDEN AVE.
IRVING	JOAN	\$25,641.00	123 E 32 ST.
JONES	DIANE	\$18,115.00	235 MURRAY HIL PKWY
MCCOY	JOHN	\$18,480.00	2 PENN PLAZA
MCKNIGHT	ROGER	\$15,550.00	117 HARRISON AVE.
ROMANS	ANTHONY	\$21,120.00	271 PRESIDENT ST.
SMITH	MARY	\$13,200.00	2 PENN PLAZA
	RICHARD	\$9,275.00	136 E 161 ST.
STEVENS	ALFRED	\$10,500.00	2 PENN PLAZA

Including Missing Instances in Reports With the ALL. Prefix

If a request excludes parent segment instances that lack descendants, you can include the parent instances by attaching the ALL. prefix to one of the fields in the parent segment.

Note that if the request contains WHERE or IF criteria that screen fields in segments that have missing instances, the report omits parent instances even when you use the ALL. prefix. To include these instances, use the SET ALL=PASS command described in [Including Missing Segment Instances With the ALL. Prefix.](#)

Including Missing Segment Instances With the ALL. Prefix

The following request displays the salary history of each employee. Although employees Elizabeth Davis and David Gardner have no salary histories, they are included in the report.

```
TABLE FILE EMPLOYEE
PRINT SALARY
BY ALL.LAST_NAME BY FIRST_NAME
BY DAT_INC
END
```

The output is:

LAST_NAME	FIRST_NAME	DAT_INC	SALARY
-----	-----	-----	-----
BANNING	JOHN	82/08/01	\$29,700.00
BLACKWOOD	ROSEMARIE	82/04/01	\$21,780.00
CROSS	BARBARA	81/11/02	\$25,775.00
		82/04/09	\$27,062.00
DAVIS	ELIZABETH	.	.
GARDNER	DAVID	.	.
GREENSPAN	MARY	82/04/01	\$8,650.00
		82/06/11	\$9,000.00
IRVING	JOAN	82/01/04	\$24,420.00
		82/05/14	\$26,862.00
JONES	DIANE	82/05/01	\$17,750.00
		82/06/01	\$18,480.00
MCCOY	JOHN	82/01/01	\$18,480.00
MCKNIGHT	ROGER	82/02/02	\$15,000.00
		82/05/14	\$16,100.00
ROMANS	ANTHONY	82/07/01	\$21,120.00
SMITH	MARY	82/01/01	\$13,200.00
	RICHARD	82/01/04	\$9,050.00
		82/05/14	\$9,500.00
STEVENS	ALFRED	81/01/01	\$10,000.00
		82/01/01	\$11,000.00

Including Missing Instances in Reports With the SET ALL Parameter

You can control how parent instances with missing descendants are processed by issuing the SET ALL command before executing the request. In a join, issuing the SET ALL = ON command controls left outer join processing.

i Note: A request with WHERE or IF criteria, which screen fields in a segment that has missing instances, omits instances in the parent segment even if you use the SET ALL=ON command. To include these instances, use the SET ALL=PASS command.

In , the command SET ALL = ON or JOIN LEFT_OUTER specifies a left outer join. With a left outer join, all records from the host file display on the report output. If a cross-referenced segment instance does not exist for a host segment instance, the report output displays missing values for the fields from the cross-referenced segment.

If there is a screening condition on the dependent segment, those dependent segment instances that do not satisfy the screening condition are omitted from the report output, and so are their corresponding host segment instances. With missing segment instances, tests for missing values fail because the fields in the segment have not been assigned missing values.

When a relational engine performs a left outer join, it processes host records with missing cross-referenced segment instances slightly differently from the way it processes those records when both of the following conditions apply:

- There is a screening condition on the cross-referenced segment.
- A host segment instance does not have a corresponding cross-referenced segment instance. This is called a **short path**.

When these two conditions are true, omit the host record from the report output, while relational engines supply null values for the fields from the dependent segment and then apply the screening condition. If the missing values pass the screening condition, the entire record is retained on the report output. This type of processing is useful for finding or counting all host records that do not have matching records in the cross-referenced file or for creating a DEFINE-based join from the cross-referenced segment with the missing instance to another dependent segment.

If you want to assign null values to the fields in a missing segment instance when a left outer join is in effect, you can issue the command SET SHORTPATH=SQL.

Include a Parent Instance With Missing Descendants

```
SET ALL= {OFF|ON|PASS}
```

where:

OFF

Omits parent instances that are missing descendants from the report. OFF is the default value.

ON

Includes parent instances that are missing descendants in the report. However, if a test on a missing segment fails, this causes the parent to be omitted from the output. It is comparable to the ALL. prefix.

PASS

Includes parent instances that are missing descendants, even if WHERE or IF criteria exist to screen fields in the descendant segments that are missing instances (that is, a test on a missing segment passes).

Including Missing Segment Instances With SET ALL

The following request displays all employees, regardless of whether they have taken a course or not since the ALL=PASS command is set.

If the ALL=ON command had been used, employees that had not taken courses would have been omitted because of the WHERE criteria.

```
JOIN EMPDATA.PIN IN EMPDATA TO ALL TRAINING.PIN IN TRAINING AS JOIN1  
SET ALL = PASS  
TABLE FILE EMPDATA
```

```

PRINT LASTNAME AND FIRSTNAME AND COURSECODE AND EXPENSES
BY PIN
WHERE EXPENSES GT 3000
END

```

The output is:

PIN	LASTNAME	FIRSTNAME	COURSECODE	EXPENSES
000000020	BELLA	MICHAEL	.	.
000000040	ADAMS	RUTH	EDP750	3,400.00
000000050	ADDAMS	PETER	UMI720	3,300.00
000000060	PATEL	DORINA	.	.
000000070	SANCHEZ	EVELYN	.	.
000000080	SO	PAMELA	EDP690	3,200.00
	SO	PAMELA	BIT420	3,350.00
000000090	PULASKI	MARIANNE	.	.
000000100	ANDERSON	TIM	NAMA930	3,100.00
000000130	CVEK	MARCUS	.	.
000000140	WHITE	VERONICA	BIT420	3,600.00
000000150	WHITE	KARL	UNI780	3,400.00
000000170	MORAN	WILLIAM	.	.
000000190	MEDINA	MARK	EDP690	3,150.00
000000220	LEWIS	CASSANDRA	.	.
000000230	NOZAWA	JIM	.	.
000000300	SOPENA	BEN	.	.
000000340	GOTLIEB	CHRIS	SSI670	3,300.00
	GOTLIEB	CHRIS	EDP750	3,450.00
000000350	FERNSTEIN	ERWIN	UMI720	3,350.00
000000380	ELLNER	DAVID	UNI780	3,350.00
000000390	GRAFF	ELAINE	.	.
000000400	LOPEZ	ANNE	.	.
000000410	CONTI	MARSHALL	EDP690	3,100.00

Control Short Path Processing In a Left Outer Join

```
SET SHORTPATH = {FOCUS|SQL}
```

where:

FOCUS

Omits a host segment from the report output when it has no corresponding cross-referenced segment and the report has a screening condition on the cross-referenced

segment.

SQL

Supplies missing values for the fields in a missing cross-referenced segment in an outer join. Applies screening conditions against this record and retains the record on the report output if it passes the screening test.

i Note: There must be an outer join in effect, either as a result of the SET ALL=ON command or a JOIN LEFT_OUTER command (either inside or outside of the Master File).

Usage Notes for SET SHORTPATH = SQL

A FOCUS data source is supported as the host file in a join used with SET SHORTPATH = SQL, but not as the cross-referenced file.

Controlling Outer Join Processing

The following procedure creates two Oracle tables, ORAEMP and ORAEDUC, that will be used in a join.

```
TABLE FILE EMPLOYEE
SUM LAST_NAME FIRST_NAME CURR_SAL CURR_JOBCODE DEPARTMENT
BY EMP_ID
ON TABLE HOLD AS ORAEMP FORMAT SQLORA
END
-RUN
TABLE FILE EDUCFILE
SUM COURSE_CODE COURSE_NAME
BY EMP_ID BY DATE_ATTEND
ON TABLE HOLD AS ORAEDUC FORMAT SQLORA
END
```

The following request joins the two Oracle tables and creates a left outer join (SET ALL = ON).

```

JOIN EMP_ID IN ORAEMP TO ALL EMP_ID IN ORAEDUC AS J1
SET ALL = ON
TABLE FILE ORAEMP
PRINT COURSE_CODE COURSE_NAME
BY EMP_ID
END

```

Since the join is an outer join, all ORAEMP rows display on the report output. ORAEMP rows with no corresponding ORAEDUC row display the missing data symbol for the fields from the ORAEDUC table.

EMP_ID	COURSE_CODE	COURSE_NAME
-----	-----	-----
071382660	101	FILE DESCRPT & MAINT
112847612	101	FILE DESCRPT & MAINT
	103	BASIC REPORT PREP FOR PROG
117593129	101	FILE DESCRPT & MAINT
	103	BASIC REPORT PREP FOR PROG
	201	ADVANCED TECHNIQUES
	203	FOCUS INTERNALS
119265415	108	BASIC RPT NON-DP MGRS
119329144	.	.
123764317	.	.
126724188	.	.
219984371	.	.
326179357	104	FILE DESC & MAINT NON-PROG
	106	TIMESHARING WORKSHOP
	102	BASIC REPORT PREP NON-PROG
	301	DECISION SUPPORT WORKSHOP
	202	WHAT'S NEW IN FOCUS
451123478	101	FILE DESCRPT & MAINT
543729165	.	.
818692173	107	BASIC REPORT PREP DP MGRS

The following request adds a screening condition on the ORAEDUC segment. To satisfy the screening condition, the course name must either contain the characters **BASIC** or be missing.

```

JOIN CLEAR
JOIN EMP_ID IN ORAEMP TO ALL EMP_ID IN ORAEDUC AS J1
SET ALL = ON
TABLE FILE ORAEMP
PRINT COURSE_CODE COURSE_NAME
BY EMP_ID

```

```
WHERE COURSE_NAME CONTAINS 'BASIC' OR COURSE_NAME IS MISSING
END
```

However, with SET ALL = ON, the rows with missing values are not retained on the report output.

EMP_ID	COURSE_CODE	COURSE_NAME
112847612	103	BASIC REPORT PREP FOR PROG
117593129	103	BASIC REPORT PREP FOR PROG
119265415	108	BASIC RPT NON-DP MGRS
326179357	102	BASIC REPORT PREP NON-PROG
818692173	107	BASIC REPORT PREP DP MGRS

The following request adds the SET SHORTPATH = SQL command.

```
JOIN CLEAR
JOIN EMP_ID IN ORAEMP TO ALL EMP_ID IN ORAEDUC AS J1
SET ALL = ON
SET SHORTPATH=SQL
TABLE FILE ORAEMP
PRINT COURSE_CODE COURSE_NAME
BY EMP_ID
WHERE COURSE_NAME CONTAINS 'BASIC' OR COURSE_NAME IS MISSING
END
```

The report output now displays both the records containing the characters **BASIC** and those with missing values.

EMP_ID	COURSE_CODE	COURSE_NAME
112847612	103	BASIC REPORT PREP FOR PROG
117593129	103	BASIC REPORT PREP FOR PROG
119265415	108	BASIC RPT NON-DP MGRS
119329144	.	.
123764317	.	.
126724188	.	.
219984371	.	.
326179357	102	BASIC REPORT PREP NON-PROG
543729165	.	.
818692173	107	BASIC REPORT PREP DP MGRS

Finding Host Records That Have No Matching Cross-Referenced Records

The following request counts and lists those employees who have taken no courses.

```

JOIN LEFT OUTER EMP_ID IN ORAEMP TO ALL EMP_ID IN ORAEDUC AS J1
SET ALL = ON
SET SHORTPATH=SQL
TABLE FILE ORAEMP
COUNT EMP_ID
LIST EMP_ID LAST_NAME FIRST_NAME
WHERE COURSE_NAME IS MISSING
END

```

The output is:

EMP_ID COUNT	LIST	EMP_ID	LAST_NAME	FIRST_NAME
-----	----	-----	-----	-----
5	1	119329144	BANNING	JOHN
	2	123764317	IRVING	JOAN
	3	126724188	ROMANS	ANTHONY
	4	219984371	MCCOY	JOHN
	5	543729165	GREENSPAN	MARY

Testing for Missing Instances in ibi FOCUS Data Sources

You can use the ALL PASS parameter to produce reports that include only parent instances with missing descendant values. To do so, write the request to screen out all existing instances in the segment with missing instances. After you set the ALL parameter to PASS, the report displays only the parent instances that are missing descendants.

Testing for a MISSING Instance

The following request screens all salary instances, since no SALARY can both be equal to 0 and not equal to 0.

```

SET ALL = PASS
TABLE FILE EMPLOYEE
PRINT LAST_NAME FIRST_NAME
WHERE SALARY EQ 0
WHERE SALARY NE 0
END

```

The output is:

LAST_NAME	FIRST_NAME
-----	-----
DAVIS	ELIZABETH
GARDNER	DAVID

Setting the NODATA Character String

In a report, the NODATA character string indicates no data or inapplicable data. The default NODATA character is a period. However, you can change this character designation.

Set the NODATA String

```
SET NODATA = string
```

where:

string

Is the character string used to indicate missing data in reports. The default string is a period (.). The string may be a maximum of 11 characters. Common choices are NONE, N/A, and MISSING.

Setting NODATA Not to Display Characters

If you do not want any characters, issue the command:

```
SET NODATA = ' '
```

Setting the NODATA Character String

In the following request, the NODATA character string is set to MISSING. The word MISSING displays on the report instead of the default period.

```
SET NODATA=MISSING

TABLE FILE EMPLOYEE
PRINT CURR_SAL BY LAST_NAME BY FIRST_NAME
ACROSS DEPARTMENT
END
```

The output is:

LAST_NAME	FIRST_NAME	DEPARTMENT	
		MIS	PRODUCTION
BANNING	JOHN	MISSING	\$29,700.00
BLACKWOOD	ROSEMARIE	\$21,780.00	MISSING
CROSS	BARBARA	\$27,062.00	MISSING
DAVIS	ELIZABETH	\$.00	MISSING
GARDNER	DAVID	MISSING	\$.00
GREENSPAN	MARY	\$9,000.00	MISSING
IRVING	JOAN	MISSING	\$26,862.00
JONES	DIANE	\$18,480.00	MISSING
MCCOY	JOHN	\$18,480.00	MISSING
MCKNIGHT	ROGER	MISSING	\$16,100.00
ROMANS	ANTHONY	MISSING	\$21,120.00
SMITH	MARY	\$13,200.00	MISSING
	RICHARD	MISSING	\$9,500.00
STEVENS	ALFRED	MISSING	\$11,000.00

LAST_NAME	FIRST_NAME	DEPARTMENT	
BANNING	JOHN	MIS	PRODUCTION
BANNING	JOHN	MISSING	\$29,700.00
BLACKWOOD	ROSEMARIE	\$21,780.00	MISSING
CROSS	BARBARA	\$27,062.00	MISSING
GREENSPAN	MARY	\$9,000.00	MISSING
IRVING	JOAN	MISSING	\$26,862.00
JONES	DIANE	\$18,480.00	MISSING
MCCOY	JOHN	\$18,480.00	MISSING
MCKNIGHT	ROGER	MISSING	\$16,100.00
ROMANS	ANTHONY	MISSING	\$21,120.00
SMITH	MARY	\$13,200.00	MISSING
	RICHARD	MISSING	\$9,500.00
STEVENS	ALFRED	MISSING	\$11,000.00

Joining Data Sources

You can join two or more related data sources to create a larger integrated data structure from which you can report in a single request. The joined structure is virtual. It is a way of accessing multiple data sources as if they were a single data source. Up to 1022 joins can be in effect at one time, for a total of 1023 segments, depending on the number of active segments and the number and length of the fields (there is a 32K limit on the length of all fields).

For details about data sources you can use in a join, see [Data Sources You Can and Cannot Join](#).

Types of Joins

When you join two data sources, some records in one of the files may lack corresponding records in the other file. When a report omits records that are not in both files, the join is called an inner join. When a report displays all matching records, plus all records from the host file that lack corresponding cross-referenced records, the join is called a left outer join. When a report displays all matching records plus all records from both files that lack corresponding records in the other file, the join is called a full outer join. Full outer joins are supported for relational data sources only.

The SET ALL command globally determines how all joins are implemented. If the SET ALL=ON command is issued, all joins are treated as outer joins. With SET ALL=OFF, the default, all joins are treated as inner joins.

Each JOIN command can specify explicitly which type of join to perform, locally overruling the global setting. This syntax is supported for FOCUS, XFOCUS, Relational, VSAM, IMS, and Adabas. If you do not specify the type of join in the JOIN command, the ALL parameter setting determines the type of join to perform.

You can also join data sources using one of two techniques for determining how to match records from the separate data sources. The first technique is known as an equijoin and the second is known as a conditional join. When deciding which of the two join techniques to use, it is important to know that when there is an equality condition between two data sources, it is more efficient to use an equijoin rather than a conditional join.

You can use an equijoin structure when you are joining two or more data sources that have two fields, one in each data source, with formats (character, numeric, or date) and values in common. Joining a product code field in a sales data source (the host file) to the product code field in a product data source (the cross-referenced file) is an example of an equijoin. For more information on using equijoins, see [Creating an Equijoin](#).

The conditional join uses WHERE-based syntax to specify joins based on WHERE criteria, not just on equality between fields. Additionally, the host and cross-referenced join fields do not have to contain matching formats. Suppose you have a data source that lists employees by their ID number (the host file), and another data source that lists training courses and the employees who attended those courses (the cross-referenced file). Using a conditional join, you could join an employee ID in the host file to an employee ID in the cross-referenced file to determine which employees took training courses in a given date range (the WHERE condition). For more information on conditional joins, see [Using a Conditional Join](#).

Joins can also be unique or non-unique. A unique, or one-to-one, join structure matches one value in the host data source to one value in the cross-referenced data source. Joining an employee ID in an employee data source to an employee ID in a salary data source is an example of a unique equijoin structure.

A non-unique, or one-to-many, join structure matches one value in the host data source to multiple values in the cross-referenced field. Joining an employee ID in a company's employee data source to an employee ID in a data source that lists all the training classes offered by that company results in a listing of all courses taken by each employee, or a joining of the one instance of each ID in the host file to the multiple instances of that ID in the cross-referenced file.

For more information on unique and non-unique joins, see [Unique and Non-Unique Joined Structures](#).

Joined Data Structure

Consider the SALES and PRODUCT data sources. Each store record in SALES may contain many instances of the PROD_CODE field. It would be redundant to store the associated product information with each instance of the product code. Instead, PROD_CODE in the SALES data source is joined to PROD_CODE in the PRODUCT data source. PRODUCT contains a single instance of each product code and related product information, thus saving space and making it easier to maintain product information. The joined structure, which is an example of an equijoin, is illustrated below:

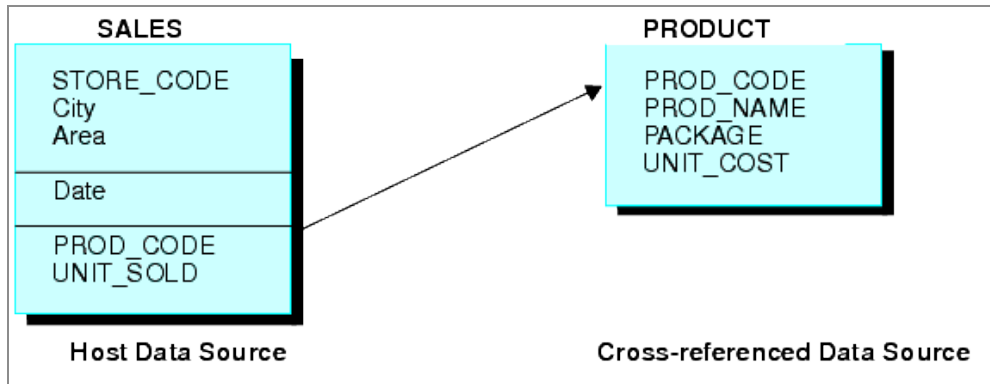

Data Sources You Can and Cannot Join

The use of data sources as host files and cross-referenced files in joined structures depends on the types of data sources you are joining:

- Typically, joins can be established between any FOCUS-readable files.
- Data sources protected by DBA security may be joined, with certain restrictions. For details, see [Notes on DBA Security for Joined Data Structures](#).
- Conditional joins are supported only for FOCUS, VSAM, ADABAS, IMS, and all relational data sources.

Notes on DBA Security for Joined Data Structures

- You can join a data source with DBA protection to another data source with DBA protection, as long as they use the same password.
- In addition, you can join DBA protected data sources with different passwords by adding the DBAFILE attribute to your security definition. The DBAFILE attribute names a central Master File that contains different passwords and restrictions for several Master Files. If you use a DBAFILE, a user can set separate passwords for each file using the syntax:

```
SET PASS = pswd1 IN file1, pswd2 IN file2
```

Individual DBA information remains in effect for each file in the JOIN. For details about the DBAFILE attribute, see the *ibi™ FOCUS® Describing Data* manual.

- You can also join a DBA-protected host file to an unprotected cross-referenced file. The DBA information is taken from the host file.

Unique and Non-Unique Joined Structures

In a unique joined structure, one value in the host field corresponds to one value in the cross-referenced field. In a non-unique joined structure, one value in the host field corresponds to multiple values in the cross-referenced field.

The ALL parameter in a JOIN command indicates that the joined structure is non-unique.

- Omit the ALL parameter only when you are sure that the joined structure is unique. Omitting the ALL parameter reduces overhead.
- The ALL parameter does not interfere with the proper creation of the joined structure even if it is unique. Use the ALL parameter if you are not sure whether the joined structure is unique. This ensures that your reports contain all relevant data from the cross-referenced file, regardless of whether the structure is unique.

A Unique Equijoin Structure

The following example illustrates a unique joined structure. Two FOCUS data sources are joined together: an EMPDATA data source and a SALHIST data source. Both data sources are organized by PIN, and they are joined on a PIN field in the root segments of both files. Each PIN has one segment instance in the EMPDATA data source, and one instance in the SALHIST data source. To join these two data sources, issue this JOIN command:

```
JOIN PIN IN EMPDATA TO PIN IN SALHIST
```

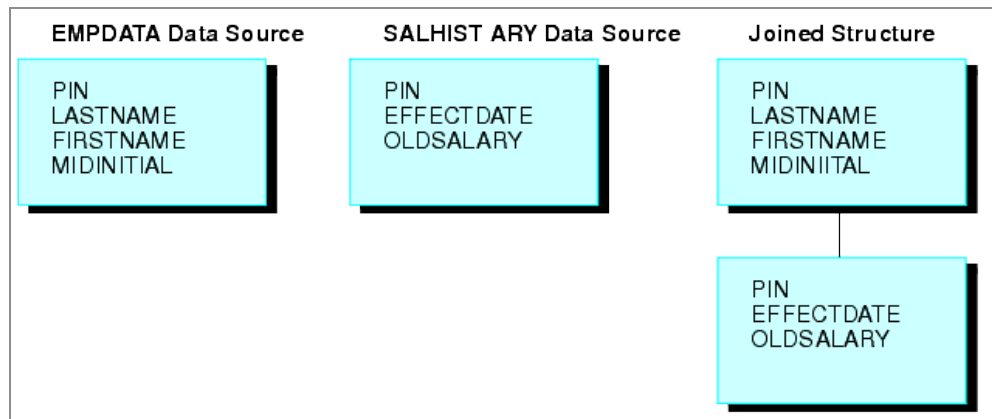

A Non-Unique Equijoin Structure

If a field value in the host file can appear in many segment instances in the cross-referenced file, then you should include the ALL phrase in the JOIN syntax. This structure is called a non-unique joined structure.

For example, assume that two FOCUS data sources are joined together: the JOB data source and an EDUCFILE data source which records employee attendance at in-house courses. The joined structure is shown in the following diagram.

The JOB data source is organized by employee, but the EDUCFILE data source is organized by course. The data sources are joined on the EMP_ID field. Since an employee has one position but can attend several courses, the employee has one segment instance in the JOB data source but can have as many instances in the EDUCFILE data source as courses attended.

To join these two data sources, issue the following JOIN command, using the ALL phrase:

```
JOIN EMP_ID IN JOB TO ALL EMP_ID IN EDUCFILE
```

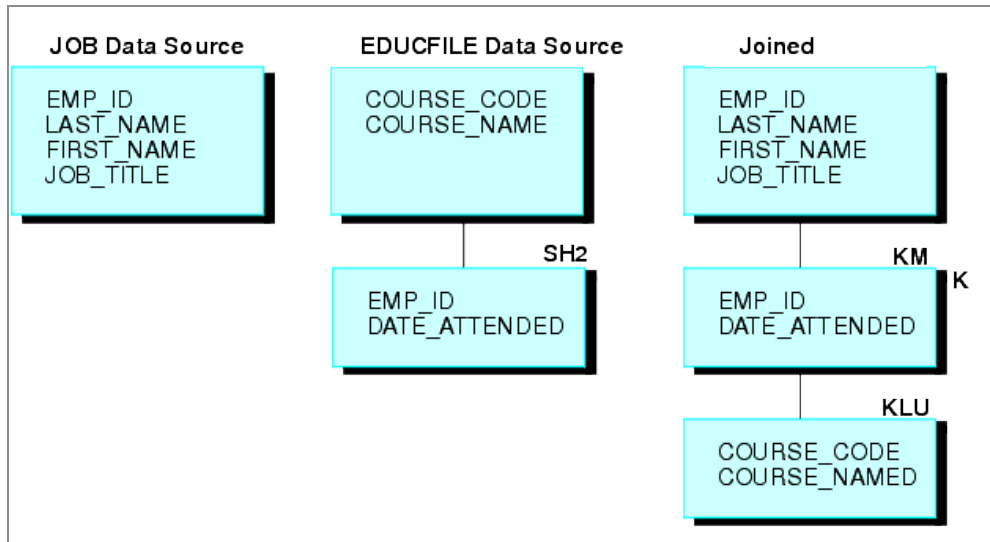

Correct for Lagging Values With a Unique Join

If a parent segment has two or more unique child segments that each have multiple children, the report may incorrectly display a missing value. The remainder of the child values may then be misaligned in the report. These misaligned values are called lagging values. The JOINOPT parameter ensures proper alignment of your output by correcting for lagging values.

```
SET JOINOPT={NEW|OLD|GNTINT}
```

where:

NEW

Specifies that segments be retrieved from left to right and from top to bottom, which results in the display of all data for each record, properly aligned. Missing values only occur when they exist in the data.

OLD

Specifies that segments be retrieved as unique segments, which results in the display of missing data in a report where all records should have values. This might cause lagging values. OLD is the default value.

GNTINT

Specifies that segments be retrieved from left to right and from top to bottom, which results in the display of all data for each record, properly aligned. Missing values only occur when they exist in the data.

i **Note:** The value GNTINT both corrects for lagging values and enables joins between different numeric data types, as described in [Joining Fields With Different Numeric Data Types](#).

Correcting for Lagging Values in a Procedure With Unique Segments and Multiple Children

This example is a hypothetical scenario in which you would use the JOINOPT parameter to correct for lagging values. Lagging values display missing data such that each value appears off by one line.

A single-segment host file (ROUTES) is joined to two files (ORIGIN and DEST), each having two segments. The files are joined to produce a report that shows each train number, along with the city that corresponds to each station.

The following request prints the city of origin (OR_CITY) and the destination city (DE_CITY). Note that missing data is generated, causing the data for stations and corresponding cities to lag, or be off by one line.

```
TABLE FILE ROUTES
PRINT TRAIN_NUM
OR_STATION OR_CITY
DE_STATION DE_CITY
END
```

The output is:

TRAIN_NUM	OR_STATION	OR_CITY	DE_STATION	DE_CITY
-----	-----	-----	-----	-----
101	NYC	NEW YORK	ATL	.
202	BOS	BOSTON	BLT	ATLANTA
303	DET	DETROIT	BOS	BALTIMORE
404	CHI	CHICAGO	DET	BOSTON

505	BOS	BOSTON	STL	DETROIT
505	BOS	.	STL	ST. LOUIS

Issuing SET JOINOPT=NEW enables segments to be retrieved in the expected order (from left to right and from top to bottom), without missing data.

```
SET JOINOPT=NEW
TABLE FILE ROUTES
PRINT TRAIN_NUM
OR_STATION OR_CITY
DE_STATION DE_CITY
END
```

The correct report has only 5 lines instead of 6, and the station and city data is properly aligned. The output is:

TRAIN_NUM	OR_STATION	OR_CITY	DE_STATION	DE_CITY
-----	-----	-----	-----	-----
101	NYC	NEW YORK	ATL	ATLANTA
202	BOS	BOSTON	BLT	BALTIMORE
303	DET	DETROIT	BOS	BOSTON
404	CHI	CHICAGO	DET	DETROIT
505	BOS	BOSTON	STL	ST. LOUIS

Recursive Joined Structures

You can join a FOCUS or IMS data source to itself, creating a recursive structure. In the most common type of recursive structure, a parent segment is joined to a descendant segment, so that the parent becomes the child of the descendant. This technique (useful for storing bills of materials, for example) enables you to report from data sources as if they have more segment levels than is actually the case.

Understanding Recursive Joined Structures

For example, the GENERIC data source shown below consists of Segments A and B.

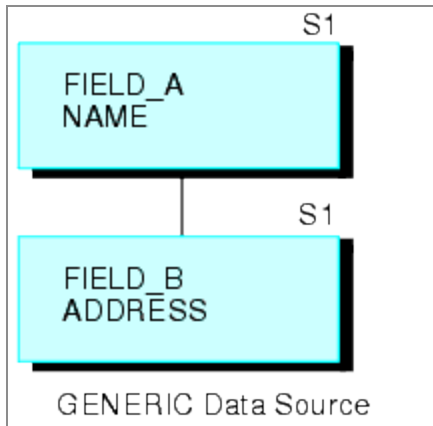

The following request creates a recursive structure:

```
JOIN FIELD_B IN GENERIC TAG G1 TO FIELD_A IN GENERIC TAG G2 AS RECURSIV
```

This results in the joined structure (shown below).

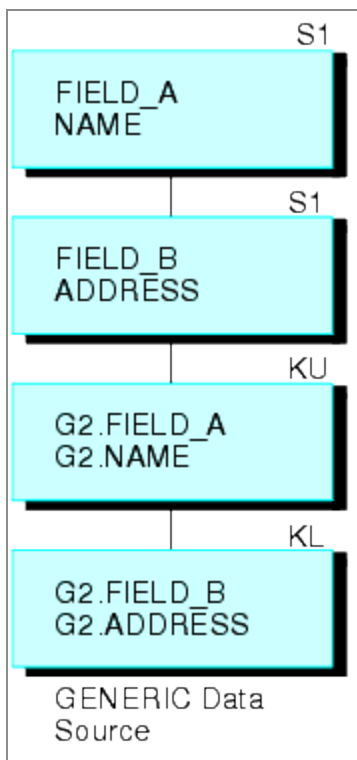

Note that the two segments are repeated on the bottom. To refer to the fields in the repeated segments (other than the field to which you are joining), prefix the tag names to the field names and aliases and separate them with a period, or append the first four characters of the JOIN name to the field names and aliases. In the above example, the

JOIN name is RECURSIV. You should refer to FIELD_B in the bottom segment as G2.FIELD_B (or RECUFIELD_B). For related information, see [Usage Notes for Recursive Joined Structures](#).

Usage Notes for Recursive Joined Structures

- You must either specify a unique JOIN name, or use tag names in the JOIN command. Otherwise, you will not be able to refer to the fields in the repeated segments at the bottom of the join structure.
- If you use tag names in a recursive joined structure, note the following guidelines:
 - If tag names are specified in a recursive join, duplicate field names must be qualified with the tag name.
 - If a join name is specified and tag names are not specified in a recursive join, duplicate field names must be prefixed with the first four characters of the join name.
 - If both a join name and a tag name are specified in a recursive join, the tag name must be used as a qualifier.
 - The tag name must be used as the field name qualifier in order to retrieve duplicate field names in a non-recursive join. If you do not qualify the field name, the first occurrence is retrieved.
- You may use a DEFINE-based join (see [Join From a Virtual Field to a Real Field](#)) to join a virtual field in a descendant segment to a field in the parent segment.
- You can extend a recursive structure by issuing multiple JOIN commands from the bottom repeat segment in the structure to the parent segment, creating a structure up to 16 levels deep.
- For FOCUS data sources, the field in the parent segment to which you are joining must be indexed.
- For IMS data sources, the following applies:
 - The parent segment must be the root segment of the data source.
 - The field to which you are joining must be both a key field and a primary or secondary index.

- You need a duplicate PCB in the PSB for every recursive join you create.

Using Recursive Joined Structures

This example explains how to use recursive joins to store and report on a bill of materials. Suppose you are designing a data source called AIRCRAFT that contains the bill of materials for an aircraft manufactured by a company. The data source records data on three levels of airplane parts:

- Major divisions, such as the cockpit or cabin.
- Parts of divisions, such as instrument panels and seats.
- Subparts, such as nuts and bolts.

The data source must record each part, the part description, and the smaller parts composing the part. Some parts, such as nuts and bolts, are common throughout the aircraft. If you design a three-segment structure, one segment for each level of parts, descriptions of common parts are repeated in every place they are used.

To reduce this repetition, design a data source that has only two segments (shown in the following diagram). The top segment describes each part of the aircraft, large and small. The bottom segment lists the component parts without descriptions.

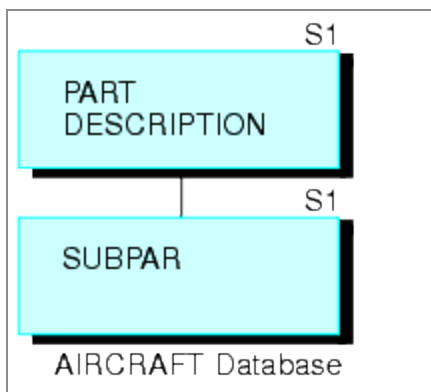

Every part (except for the largest divisions) appears in both the top segment, where it is described, and in the bottom segment, where it is listed as one of the components of a larger part. (The smallest parts, such as nuts and bolts, appear in the top segment without an instance of a child in the bottom segment.) Note that each part, no matter how often it is used in the aircraft, is described only once.

If you join the bottom segment to the top segment, the descriptions of component parts in the bottom segment can be retrieved. The first-level major divisions can also be related to

third-level small parts, going from the first level to the second level to the third level. Thus, the structure behaves as a three-level data source, although it is actually a more efficient two-level source.

For example, CABIN is a first-level division appearing in the top segment. It lists SEATS as a component in the bottom segment. SEATS also appears in the top segment. It lists BOLTS as a component in the bottom segment. If you join the bottom segment to the top segment, you can go from CABIN to SEATS and from SEATS to BOLTS.

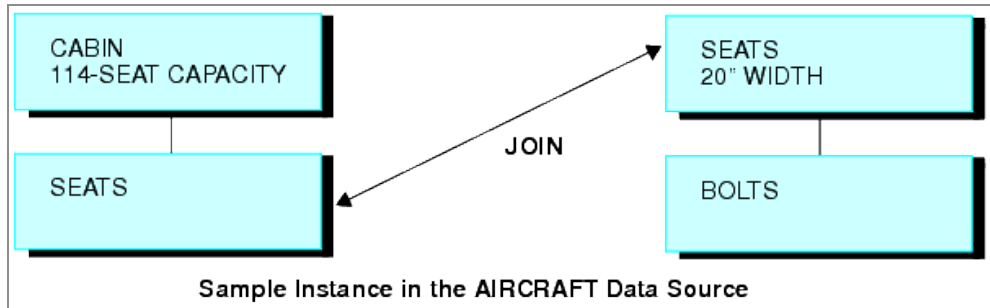

Join the bottom segment to the top segment with this JOIN command:

```
JOIN SUBPART IN AIRCRAFT TO PART IN AIRCRAFT AS SUB
```

This creates the following recursive structure.

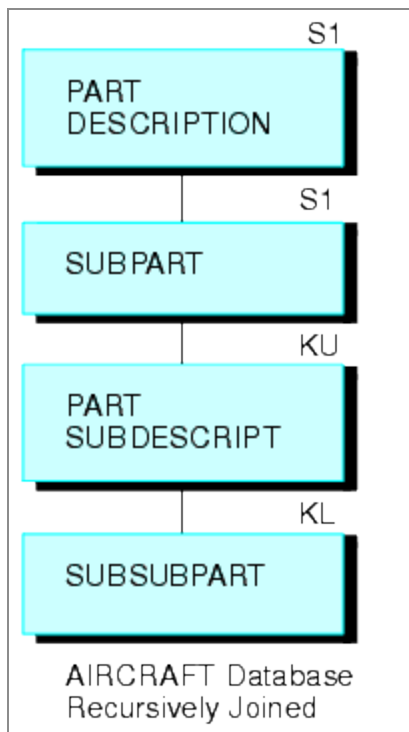

You can then produce a report on all three levels of data with this TABLE command (the field SUBDESCRIPT describes the contents of the field SUBPART):

```
TABLE FILE AIRCRAFT
PRINT SUBPART BY PART BY SUBPART BY SUBDESCRIPT
END
```

How the JOIN Command Works

The JOIN command enables you to report from two or more related data sources with a single request. Joined data sources remain physically separate, but are treated as one. Up to 1022 joins can be in effect at any one time. The join applies to all requests run during the session in which it is issued, unless it is explicitly cleared. For details about session boundaries in FOCUS, see the *Developing Applications* manual.

When two data sources are joined, one is called the host file; the other is called the cross-referenced file. Each time a record is retrieved from the host file, the corresponding fields in the cross-referenced file are identified if they are referenced in the report request. The records in the cross-referenced file containing the corresponding values are then retrieved.

Two data sources can be joined using a conditional join whenever you can define an expression that determines how to relate records in the host file to records in the cross-referenced file. Two data sources can be joined using an equijoin when they have fields in each data source with formats (character, numeric, or date) and values in common. The common formats ensure proper interpretation of the values. For example, suppose that you need to read data from two data sources: one named JOB, containing job information, and a second named SALARY, containing salary information. You can join these two data sources if each has a field identifying the same group of employees in the same way: by last name, serial number, or social security number. The join becomes effective when common values (for example, common social security numbers) are retrieved for the joined fields.

After you issue the JOIN command, you can issue a single TABLE, TABLEF, MATCH FILE, or GRAPH request to read the joined data source. You only need to specify the first data source (host file) to produce a report from two or more data sources. For example, assume you are writing a report from the JOB and SALARY data sources. You execute the following equijoin:

```
JOIN EMP_ID IN JOB TO ALL EMP_ID IN SALARY
```

This command joins the field EMP_ID in the JOB file to the field EMP_ID in the SALARY file. JOB is the host file and SALARY is the cross-referenced file. You then execute this report request:

```
TABLE FILE JOB
PRINT SALARY AND JOB_TITLE BY EMP_ID
END
```

The first record retrieved is a JOB file record for employee #071382660. Next, all records in the SALARY data source containing employee #071382660 are retrieved. This process continues until all the records have been read.

You can base your join on:

- Real fields that have been declared in the Master Files of the host and cross-referenced data sources, respectively. See [Join Real Fields](#).
- A virtual field in the host data source (that has either been defined in the Master File or with a DEFINE command) and a real field that has been declared in the Master File of the cross-referenced data source. See [Join From a Virtual Field to a Real Field](#).
- A condition you specify in the JOIN command itself. See [Using a Conditional Join](#).

Increasing Retrieval Speed in Joined Data Sources

You can increase retrieval speed in joined structures by using an external index. However, the target segment for the index cannot be a cross-referenced segment. For related information, see [Improving Report Processing](#).

Creating an Equijoin

The most common joined structures are based on real fields that have been declared in the Master Files of the host and cross-referenced data sources, respectively.

Join Real Fields

The following JOIN syntax requires that the fields you are using to join the files are real fields declared in the Master File. This join may be a simple one based on one field in each file to be joined, or a multi-field join for data sources that support this type of behavior. The following syntax describes the simple and multi-field variations:

```
JOIN [LEFT_OUTER|RIGHT_OUTER|INNER] hfld1 [AND hfld2 ...] IN hostfile
[TAG tag1]
  TO [UNIQUE|MULTIPLE]
    crfield [AND crfld2 ...] IN crfile [TAG tag2] [AS joinname]
END
```

where:

JOIN hfld1

Is the name of a field in the host file containing values shared with a field in the cross-referenced file. This field is called the host field.

AND hfld2...

Can be an additional field in the host file, with the caveats noted below. The phrase beginning with AND is required when specifying multiple fields.

- For adapters that support multi-field and concatenated joins, and FOCUS or XFOCUS data sources when SET NFOC=ON (the default), you can specify up to 128 fields. See your data adapter documentation for specific information about supported join features for each adapter.
- When you are joining two FOCUS data sources, and SET NFOC=OFF, you can specify up to four alphanumeric fields in the host file that, if concatenated, contain values shared with the cross-referenced file. You may not specify more than one field in the cross-referenced file when the suffix of the file is FOC. For example, assume the cross-referenced file contains a phone number field with an area code-prefix-exchange format. The host file has an area code field, a prefix field, and an exchange field. You can specify these three fields to join them to the phone number field in the cross-referenced file. The JOIN command treats the three fields as one. Other data sources do not have this restriction on the cross-referenced file.

INNER

Specifies an inner join. If you do not specify the type of join in the JOIN command, the ALL parameter setting determines the type of join to perform.

LEFT_OUTER

Specifies a left outer join. If you do not specify the type of join in the JOIN command, the ALL parameter setting determines the type of join to perform.

Note that in a left outer join, host records with a missing cross-referenced instance are included in the report output. To control how tests against missing cross-referenced segment instances are processed, use the SET SHORTPATH command described in [Handling a Missing Segment Instance](#).

RIGHT_OUTER

Specifies a right outer join. This option is available for relational data sources that support this type of join. Using this option requires that you issue the SET SHORTPATH = SQL command.

Note that in a right outer join, cross-referenced records with a missing host instance are included in the report output.

IN hostfile

Is the name of the host file.

TAG tag1

Is a tag name of up to 66 characters (usually the name of the Master File), which is used as a unique qualifier for fields and aliases in the host file.

The tag name for the host file must be the same in all the JOIN commands of a joined structure.

TO [UNIQUE|MULTIPLE] crfld1

Is the name of a field in the cross-referenced file containing values that match those of *hfld1* (or of concatenated host fields). This field is called the cross-referenced field.

i Note: Unique returns only one instance and, if there is no matching instance in the cross-referenced file, it supplies default values (blank for alphanumeric fields and zero for numeric fields).

Use the `MULTIPLE` parameter when `crfld1` may have multiple instances in common with one value in `hfld1`. Note that `ALL` is a synonym for `MULTIPLE`, and omitting this parameter entirely is a synonym for `UNIQUE`. See [Unique and Non-Unique Joined Structures](#) for more information.

AND crfld2...

Is the name of a field in the cross-referenced file with values in common with `hfld2`.

i Note: `crfld2` may be qualified. This field is only available for data adapters that support multi-field joins.

IN crfile

Is the name of the cross-referenced file.

TAG tag2

Is a tag name of up to 66 characters (usually the name of the Master File), which is used as a unique qualifier for fields and aliases in cross-referenced files. In a recursive join structure, if no tag name is provided, all field names and aliases are prefixed with the first four characters of the join name. For related information, see [Usage Notes for Recursive Joined Structures](#).

The tag name for the host file must be the same in all the `JOIN` commands of a joined structure.

AS joinname

Is an optional name of up to eight characters that you may assign to the join structure. You must assign a unique name to a join structure if:

- You want to ensure that a subsequent `JOIN` command does not overwrite it.
- You want to clear it selectively later.
- The structure is recursive. See [Types of Joins](#).

i Note: If you do not assign a name to the join structure with the `AS` phrase, the name is assumed to be blank. A join without a name overwrites an existing join without a name.

END

Required when the JOIN command is longer than one line. It terminates the command. It must be on a line by itself.

Creating a Simple Unique Joined Structure

An example of a simple unique join is shown below:

```
JOIN JOBCODE IN EMPLOYEE TO JOBCODE IN JOBFILE AS JJOIN
```

Creating an Inner Join

The following procedure creates three FOCUS data sources:

- EMPINFO, which contains the fields EMP_ID, LAST_NAME, FIRST_NAME, and CURR_JOBCODE from the EMPINFO segment of the EMPLOYEE data source.
- JOBINFO, which contains the JOBCODE and JOB_DESC fields from the JOBFILE data source.
- EDINFO, which contains the EMP_ID, COURSE_CODE, and COURSE_NAME fields from the EDUCFILE data source.

The procedure then adds an employee to EMPINFO named Fred Newman who has no matching record in the JOBINFO or EDINFO data sources.

```
TABLE FILE EMPLOYEE
SUM LAST_NAME FIRST_NAME CURR_JOBCODE
BY EMP_ID
ON TABLE HOLD AS EMPINFO FORMAT FOCUS INDEX EMP_ID CURR_JOBCODE
END
-RUN

TABLE FILE JOBFILE
SUM JOB_DESC
BY JOBCODE
ON TABLE HOLD AS JOBINFO FORMAT FOCUS INDEX JOBCODE
END
-RUN
```

```

TABLE FILE EDUCFILE
SUM  COURSE_CODE  COURSE_NAME
BY  EMP_ID
ON  TABLE HOLD AS EDINFO FORMAT FOCUS INDEX EMP_ID
END
-RUN

MODIFY FILE EMPINFO
FREEFORM EMP_ID LAST_NAME FIRST_NAME CURR_JOBCODE
MATCH EMP_ID
ON NOMATCH INCLUDE
ON MATCH REJECT
DATA
111111111, NEWMAN, FRED, C07,$
END

```

The following request prints the contents of EMPINFO. Note that Fred Newman has been added to the data source:

```

TABLE FILE EMPINFO
PRINT *
END

```

The output is:

EMP_ID	LAST_NAME	FIRST_NAME	CURR_JOBCODE
-----	-----	-----	-----
071382660	STEVENS	ALFRED	A07
112847612	SMITH	MARY	B14
117593129	JONES	DIANE	B03
119265415	SMITH	RICHARD	A01
119329144	BANNING	JOHN	A17
123764317	IRVING	JOAN	A15
126724188	ROMANS	ANTHONY	B04
219984371	MCCOY	JOHN	B02
326179357	BLACKWOOD	ROSEMARIE	B04
451123478	MCKNIGHT	ROGER	B02
543729165	GREENSPAN	MARY	A07
818692173	CROSS	BARBARA	A17
111111111	NEWMAN	FRED	C07

The following JOIN command creates an inner join between the EMPINFO data source and the JOBINFO data source.

```
JOIN CLEAR *
JOIN INNER CURR_JOBCODE IN EMPINFO TO MULTIPLE JOBCODE IN JOBINFO AS J0
```

Note that the JOIN command specifies a multiple join. In a unique join, the cross-referenced segment is never considered missing, and all records from the host file display on the report output. Default values (blank for alphanumeric fields and zero for numeric fields) display if no actual data exists.

The following request displays fields from the joined structure:

```
TABLE FILE EMPINFO
PRINT LAST_NAME FIRST_NAME JOB_DESC
END
```

Fred Newman is omitted from the report output because his job code does not have a match in the JOBINFO data source:

LAST_NAME	FIRST_NAME	JOB_DESC
-----	-----	-----
STEVENS	ALFRED	SECRETARY
SMITH	MARY	FILE QUALITY
JONES	DIANE	PROGRAMMER ANALYST
SMITH	RICHARD	PRODUCTION CLERK
BANNING	JOHN	DEPARTMENT MANAGER
IRVING	JOAN	ASSIST.MANAGER
ROMANS	ANTHONY	SYSTEMS ANALYST
MCCOY	JOHN	PROGRAMMER
BLACKWOOD	ROSEMARIE	SYSTEMS ANALYST
MCKNIGHT	ROGER	PROGRAMMER
GREENSPAN	MARY	SECRETARY
CROSS	BARBARA	DEPARTMENT MANAGER

Creating a Left Outer Join

The following JOIN command creates a left outer join between the EMPINFO data source and the EDINFO data source:

```
JOIN CLEAR *
JOIN LEFT_OUTER EMP_ID IN EMPINFO TO MULTIPLE EMP_ID IN EDINFO AS J1
```

The following request displays fields from the joined structure:

```
TABLE FILE EMPINFO
PRINT LAST_NAME FIRST_NAME COURSE_NAME
END
```

All employee records display on the report output. The records for those employees with no matching records in the EDINFO data source display the missing data character (.) in the COURSE_NAME column. If the join were unique, blanks would display instead of the missing data character.

LAST_NAME	FIRST_NAME	COURSE_NAME
STEVENS	ALFRED	FILE DESCRPT & MAINT
SMITH	MARY	BASIC REPORT PREP FOR PROG
JONES	DIANE	FOCUS INTERNALS
SMITH	RICHARD	BASIC RPT NON-DP MGRS
BANNING	JOHN	.
IRVING	JOAN	.
ROMANS	ANTHONY	.
MCCOY	JOHN	.
BLACKWOOD	ROSEMARIE	DECISION SUPPORT WORKSHOP
MCKNIGHT	ROGER	FILE DESCRPT & MAINT
GREENSPAN	MARY	.
CROSS	BARBARA	HOST LANGUAGE INTERFACE
NEWMAN	FRED	.

Creating a Right Outer Join

The following requests generate two Db2 tables to join, and then issues a request against the join.

The following request generates the WF_SALES table. The field ID_PRODUCT will be used in the right outer join command.

```
TABLE FILE WFLITE
SUM GROSS_PROFIT_US PRODUCT_CATEGORY PRODUCT_SUBCATEG
BY ID_PRODUCT
WHERE ID_PRODUCT FROM 2150 TO 4000
ON TABLE HOLD AS WF_SALES FORMAT DB2
END
```

The following request generates the WF_PROD table. The field ID_PRODUCT will be used in the right outer join command.

```
TABLE FILE WFLITE
SUM PRICE_DOLLARS PRODUCT_CATEGORY PRODUCT_SUBCATEG PRODUCT_NAME
BY ID_PRODUCT
WHERE ID_PRODUCT FROM 3000 TO 5000
ON TABLE HOLD AS WF_PROD FORMAT DB2
END
```

The following request issues the SET SHORTPATH=SQL and JOIN commands and displays values from the joined tables:

```
SET SHORTPATH = SQL
JOIN RIGHT OUTER ID_PRODUCT IN WF_PROD TAG T1 TO ALL ID_PRODUCT IN
WF_SALES TAG T2
END
TABLE FILE WF_PROD
PRINT T1.ID_PRODUCT AS 'Product ID'
PRICE_DOLLARS AS Price
T2.ID_PRODUCT AS 'Sales ID'
GROSS_PROFIT_US
BY T1.ID_PRODUCT NOPRINT
ON TABLE SET PAGE NOPAGE
ON TABLE SET STYLE *
GRID=OFF,$
ENDSTYLE
END
```

You can generate a trace that shows the resulting SQL by adding the following commands.

```
SET TRACEUSER=ON
SET TRACESTAMP=OFF
SET TRACEOFF=ALL
SET TRACEON = STMTRACE//CLIENT
```

The trace shows that the request was optimized as a right outer join to the RDBMS.

```
SELECT
T1."ID_PRODUCT",
T1."PRICE_DOLLARS",
T2."ID_PRODUCT",
T2."GROSS_PROFIT_US"
FROM
( WF_PROD T1
RIGHT OUTER JOIN
WF_SALES T2
```

```
ON T2."ID_PRODUCT" = T1."ID_PRODUCT" )
ORDER BY
T1."ID_PRODUCT";
```

The output, shown in the following image, has a row for each ID_PRODUCT value that is in the WF_PRODUCT table. The columns from WF_SALES rows that do not have a matching ID_PRODUCT value display the NODATA symbol.

<u>Product ID</u>	<u>Price</u>	<u>Sales ID</u>	<u>Gross Profit</u>
.	.	2151	\$7,172.24
.	.	2152	\$6,766.45
.	.	2153	\$7,291.10
.	.	2154	\$19,913.65
.	.	2155	\$12,472.93
.	.	2156	\$14,484.75
.	.	2157	\$6,223.34
.	.	2158	\$11,267.75
.	.	2159	\$9,015.75
.	.	2160	\$7,194.15
.	.	2161	\$8,683.00
.	.	2162	\$9,197.81
.	.	2163	\$21,347.98
.	.	2164	\$5,615.33
.	.	2165	\$8,540.53
.	.	2166	\$12,469.45
.	.	2167	\$6,771.26
3001	47,988.00	3001	\$12,786.30
3002	34,990.00	3002	\$5,586.10
3003	30,591.00	3003	\$12,399.15
3004	44,187.00	3004	\$8,434.95
3005	30,057.00	3005	\$8,987.80
3006	25,348.05	3006	\$6,422.59
3007	23,607.00	3007	\$8,354.60
3008	42,898.57	3008	\$18,469.01
3009	48,139.00	3009	\$22,542.75
3010	44,850.00	3010	\$16,722.15
3011	28,078.44	3011	\$18,204.82
3012	31,146.00	3012	\$19,739.45
3013	27,208.00	3013	\$17,983.00
3014	23,968.59	3014	\$19,996.09
3015	29,061.45	3015	\$17,420.72

Creating Two Inner Joins With a Multipath Structure

The following JOIN commands create an inner join between the EMPINFO and JOBINFO data sources and an inner join between the EMPINFO and EDINFO data sources:

```
JOIN CLEAR *
JOIN INNER CURR_JOBCODE IN EMPINFO TO MULTIPLE JOBCODE IN JOBINFO AS J0
JOIN INNER EMP_ID IN EMPINFO TO MULTIPLE EMP_ID IN EDINFO AS J1
```

The structure created by the two joins has two independent paths:

```

          SEG01
01      S1
*****
*EMP_ID      **I
*CURRE_JOBCODE**I
*LAST_NAME   **
*FIRST_NAME  **
*            **
*****
          I
          +-----+
          I           I
02      I SEG01      03      I SEG01
          I KM           I KM
.....
:EMP_ID      ::K  :JOBCODE      ::K
:COURSE_CODE ::  :JOB_DESC      ::
:COURSE_NAME ::  :              ::
:            ::  :              ::
:            ::  :              ::
:.....:      :.....:
.....:      :.....:
JOINED EDINFO  JOINED JOBINFO

```

The following request displays fields from the joined structure:

```

SET MULTIPATH=SIMPLE
TABLE FILE EMPINFO
PRINT LAST_NAME FIRST_NAME IN 12 COURSE_NAME JOB_DESC
END

```

With MULTIPATH=SIMPLE, the independent paths create independent joins. All employee records accepted by either join display on the report output. Only Fred Newman (who has no matching record in either of the cross-referenced files) is omitted:

LAST_NAME	FIRST_NAME	COURSE_NAME	JOB_DESC
STEVENS	ALFRED	FILE DESCRIPT & MAINT	SECRETARY
SMITH	MARY	BASIC REPORT PREP FOR PROG	FILE QUALITY
JONES	DIANE	FOCUS INTERNALS	PROGRAMMER
ANALYST			
SMITH	RICHARD	BASIC RPT NON-DP MGRS	PRODUCTION CLERK

BANNING MANAGER	JOHN	.	DEPARTMENT
IRVING	JOAN	.	ASSIST.MANAGER
ROMANS	ANTHONY	.	SYSTEMS ANALYST
MCCOY	JOHN	.	PROGRAMMER
BLACKWOOD	ROSEMARIE	DECISION SUPPORT WORKSHOP	SYSTEMS ANALYST
MCKNIGHT	ROGER	FILE DESCRPT & MAINT	PROGRAMMER
GREENSPAN	MARY	.	SECRETARY
CROSS MANAGER	BARBARA	HOST LANGUAGE INTERFACE	DEPARTMENT

With MULTIPATH=COMPOUND, only employees with matching records in both of the cross-referenced files display on the report output:

LAST_NAME	FIRST_NAME	COURSE_NAME	JOB_DESC
-----	-----	-----	-----
STEVENS	ALFRED	FILE DESCRPT & MAINT	SECRETARY
SMITH	MARY	BASIC REPORT PREP FOR PROG	FILE QUALITY
JONES ANALYST	DIANE	FOCUS INTERNALS	PROGRAMMER
SMITH	RICHARD	BASIC RPT NON-DP MGRS	PRODUCTION CLERK
BLACKWOOD	ROSEMARIE	DECISION SUPPORT WORKSHOP	SYSTEMS ANALYST
MCKNIGHT	ROGER	FILE DESCRPT & MAINT	PROGRAMMER
CROSS MANAGER	BARBARA	HOST LANGUAGE INTERFACE	DEPARTMENT

Requirements for Cross-Referenced Fields in an Equijoin

The cross-referenced fields used in a JOIN must have the following characteristics in specific data sources:

- In relational data sources and in a CA-DATACOM/DB data source, the cross-referenced field can be any field.
- In FOCUS and XFOCUS data sources, the cross-referenced field must be indexed. Indexed fields have the attribute FIELDTYPE=I or INDEX=I or INDEX=ON in the Master File. If the cross-referenced field does not have this attribute, append the attribute to the field declaration in the Master File and rebuild the file using the REBUILD utility with the INDEX option. This adds an index to your FOCUS or XFOCUS data source.

i Note: The indexed fields can be external. See the *ibi™ FOCUS® Describing Data* manual for more information about indexed fields and the Rebuild tool.

- In IMS data sources, the cross-referenced field must be a key field in the root segment. It can be a primary or secondary index.
- In fixed format or delimited sequential files, any field can be a cross-referenced field. However, both the host and cross-referenced file must be retrieved in ascending order on the named (key) fields, if the command `ENGINE INT CACHE SET OFF` is in effect. In this situation, if the data is not in the same sort order, errors are displayed and a many-to-many join is not supported. However, if `ENGINE INT CACHE SET ON` is in effect, the files do not have to be in ascending order and a many-to-many join is supported. `ON` is the default value. A delimited file used as the cross-referenced file in the join must consist of only one segment. If the join is based on multiple fields, a fixed-format sequential file must consist of a single segment. If the cross-referenced fixed-format sequential file contains only one segment, the host file must have a segment declaration.

Restrictions on Group Fields

When group fields are used in a joined structure, the group in the host file and the group in the cross-referenced file must have the same number of elements:

- In ISAM data sources, the field must be the full primary key if you issue a unique join, or an initial subset of the primary key if you issue a non-unique join. In the Master File, the primary key is described by a key `GROUP`; the initial subset is the first field in that group.
- In VSAM KSDS data sources, the field must be the full primary or alternate key if you issue a unique join, or an initial subset of the primary or alternate key if you issue a non-unique join. In the Master File, the primary key is described by a key `GROUP`. The initial subset is the first field in that group.

In VSAM ESDS data sources, the field can be any field, as long as the file is already sorted on that field.

- In Model 204 data sources, the field must be a key field. In the Access File, the types of key fields are alphanumeric (`KEY`), ordered character (`ORA`), ordered numeric

(ORN), numeric range (RNG), invisible (IVK), and invisible range (IVR).

- In ADABAS data sources, the field must be a descriptor field, a superdescriptor defined with the .SPR or .NOP field name suffix, or a subdescriptor defined with the .NOP field name suffix. The field description in the Master File must contain the attribute FIELDTYPE=I.

In the Access File, the cross-referenced segment must specify ACCESS=ADBS and either CALLTYPE=FINN or CALLTYPE=RL. If CALLTYPE=RL, the host field can be joined to the high-order portion of a descriptor, superdescriptor, or subdescriptor, if the high-order portion is longer than the host field.

- In CA-IDMS/DB data sources, the field must be an indexed field on a network record identified by the attribute FIELDTYPE=I in the Master File, a CA-IDMS/DB CALC field on a network record identified by the CLCFLD phrase in the Access File, or any field on an LRF or ASF record.
- For a partial key join using fixed format or delimited sequential files, the setting ENGINE INT CACHE SET OFF must be in effect.

Usage Notes for Inner and Outer JOIN

Command Syntax

- The SET ALL and SET CARTESIAN commands are ignored by the syntax.
- The ALL. parameter is not supported. If the ALL. parameter is used, the following message displays:

```
(FOC32452) Use of ALL. with LEFT_OUTER/INNER not allowed
```

- If you define multiple joins, the resulting structure can be a single-path or multi-path data source.
 - If the setting MULTIPATH=SIMPLE is in effect and the report is based on multiple paths, each of the individual joins is constructed separately without regard to the other joins, and the matching records from each of the separate paths displays on the report output. Therefore, the output can contain records that would have been omitted if only one of the joins was in effect.
 - If the setting MULTIPATH=COMPOUND is in effect with a multi-path report, or if

the report displays data only from a single path, the report output displays only those records that satisfy all of the joins.

Joining From a Virtual Field to a Real Field Using an Equijoin

You can use DEFINE-based JOIN syntax to create a virtual host field that you can join to a real cross-referenced field. The DEFINE expression that creates the virtual host field may contain only fields in the host file and constants. (It may not contain fields in the cross-referenced file.) You can do more than one join from a virtual field.

You can create the virtual host field in a separate DEFINE command or in a Master File. For information on Master Files, see the *ibi™ FOCUS® Describing Data* manual.

The same report request can use JOIN-based virtual fields, and virtual fields unrelated to the join.

Note that if you are creating a virtual field in a DEFINE command, you must issue the DEFINE after the JOIN command, but before the TABLE request since a JOIN command clears all fields created by DEFINE commands for the host file and the joined structure. Virtual fields defined in Master Files are not cleared.

✔ **Tip:** If a DEFINE command precedes the JOIN command, you can set KEEPDEFINES to ON or ALL to reinstate virtual fields during the parsing of a subsequent JOIN command. For more information, see [Preserving Virtual Fields During Join Parsing](#).

Join From a Virtual Field to a Real Field

The DEFINE-based JOIN command enables you to join a virtual field in the host file to a real field in the cross-referenced file. The syntax is:

```
JOIN [LEFT_OUTER|RIGHT_OUTER|INNER] deffld WITH host_field ...  
  IN hostfile [TAG tag1]  
  TO [UNIQUE|MULTIPLE]
```

```
cr_field IN crfile [TAG tag2] [AS joinname]  
END
```

where:

JOIN deffld

Is the name of a virtual field for the host file (the host field). The virtual field can be defined in the Master File or with a DEFINE command. For related information, see [Notes on Using Virtual Fields With Joined Data Sources](#).

WITH host_field

Is the name of any real field in the host segment with which you want to associate the virtual field. This association is required to locate the virtual field.

i Note: The WITH field referenced in the JOIN command must be in the same segment as the WITH field referenced in the DEFINE that creates the virtual field or no output will be produced.

The WITH phrase is required unless the KEEPDEFINES parameter is set to ON or ALL and *defld* was defined prior to issuing the JOIN command.

To determine which segment contains the virtual field, use the ? DEFINE query after issuing the DEFINE command. See the *ibi™ FOCUS® Developing Applications* manual for details about Query commands.

INNER

Specifies an inner join. If you do not specify the type of join in the JOIN command, the ALL parameter setting determines the type of join to perform.

LEFT_OUTER

Specifies a left outer join. If you do not specify the type of join in the JOIN command, the ALL parameter setting determines the type of join to perform.

RIGHT_OUTER

Specifies a right outer join. This option is available for relational data sources that support this type of join. The SET SHORTPATH = SQL command must be in effect in order to issue a right outer join.

IN hostfile

Is the name of the host file.

TAG tag1

Is a tag name of up to 66 characters (usually the name of the Master File), which is used as a unique qualifier for fields and aliases in host files.

The tag name for the host file must be the same in all JOIN commands of a joined structure.

TO [UNIQUE|MULTIPLE] crfld1

Is the name of a real field in the cross-referenced data source whose values match those of the virtual field. This must be a real field declared in the Master File.

i Note: UNIQUE returns only one instance and, if there is no matching instance in the cross-referenced file, it supplies default values (blank for alphanumeric fields and zero for numeric fields).

Use the MULTIPLE parameter when *crfld1* may have multiple instances in common with one value in *hfld1*. Note that ALL is a synonym for MULTIPLE, and omitting this parameter entirely is a synonym for UNIQUE. See [Unique and Non-Unique Joined Structures](#) for more information.

IN crfile

Is the name of the cross-referenced file.

TAG tag2

Is a tag name of up to 66 characters (usually the name of the Master File), which is used as a unique qualifier for fields and aliases in cross-referenced files. In a recursive joined structure, if no tag name is provided, all field names and aliases are prefixed with the first four characters of the join name. For related information, see [Unique and Non-Unique Joined Structures](#).

The tag name for the host file must be the same in all JOIN commands of a joined structure.

AS joinname

Is an optional name of up to eight characters that you may assign to the joined structure. You must assign a unique name to a join structure if:

- You want to ensure that a subsequent JOIN command does not overwrite it.
- You want to clear it selectively later.
- The structure is recursive, and you do not specify tag names. See [Types of Joins](#).

If you do not assign a name to the joined structure with the AS phrase, the name is assumed to be blank. A join without a name overwrites an existing join without a name.

END

Required when the JOIN command is longer than one line. It terminates the command. It must be on a line by itself.

Notes on Using Virtual Fields With Joined Data Sources

Requests reading joined data sources can contain virtual fields that are defined either:

- In the Master File of the host data source.
- In a DEFINE command, in which the syntax

```
DEFINE FILE hostfile
```

identifies the host data source in the joined structure.



Note: The expression defining the host field for the join can use only host fields and constants.

All other virtual fields can contain real fields from the host file and the cross-referenced file.

- ✔ **Tip:** Since issuing the JOIN command clears all DEFINE commands for the host file and the joined structure, you must issue the DEFINE command after the JOIN or turn KEEPDEFINES to ON or ALL to preserve the virtual fields. For more information, see [Preserving Virtual Fields During Join Parsing](#).

Creating a Virtual Host Field for a Joined Structure

Suppose that a retail chain sends four store managers to attend classes. Each person, identified by an ID number, manages a store in a different city. The stores and the cities in which they are located are contained in the SALES data source. The manager IDs, the classes, and dates the managers attended are contained in the EDUCFILE data source.

The following procedure lists the courses that the managers attended, identifying the managers by the cities in which they work. Note the three elements in the procedure:

- The JOIN command joins the SALES data source to the EDUCFILE data source, based on the values common to the ID_NUM field (which contains manager IDs) in SALES and the EMP_ID field in EDUCFILE. Note that the ID_NUM field does not exist yet and will be created by the DEFINE command.
- The DEFINE command creates the ID_NUM field, assigning to it the IDs of the managers working in the four cities.
- The TABLE command produces the report.

The procedure is:

```
JOIN ID_NUM WITH CITY IN SALES TO ALL EMP_ID IN EDUCFILE AS SALEDUC
```

```
DEFINE FILE SALES
ID_NUM/A9 = DECODE CITY ('NEW YORK' 451123478 'NEWARK' 119265415
                        'STAMFORD' 818692173 'UNIONDALE' 112847612);
END
```

```
TABLE FILE SALES
PRINT DATE_ATTEND BY CITY BY COURSE_NAME
END
```

The output is:

CITY ----	COURSE_NAME -----	DATE_ATTEND -----
NEW YORK	FILE DESCRPT & MAINT	81/11/15
NEWARK	BASIC RPT NON-DP MGRS	82/08/24
STAMFORD	BASIC REPORT PREP DP MGRS	82/08/02
	HOST LANGUAGE INTERFACE	82/10/21
UNIONDALE	BASIC REPORT PREP FOR PROG	81/11/16
	FILE DESCRPT & MAINT	81/11/15

Join Modes in an Equijoin

The JOIN_LENGTH_MODE (JOINLM) parameter controls processing of equality joined field pairs for record-based non-SQL Adapters, such as DFIX, VSAM, and FIX. This setting controls processing when two alphanumeric fields of different lengths or two numeric fields of different data types and precisions are joined.

For SQL data sources, joins are normally either optimized (sent to the SQL engine for processing) or managed to comply with SQL processing rules.

There are two supported modes of handling compatible, but not identical, joined fields:

- **SQL compliance mode.** The JOIN command processor assures strict value equality of joined fields. Detected truncation of significant characters during host to cross-referenced conversion generates *atarget not found* condition, in which case the join is not done. If a shorter host field is joined to a longer cross-referenced file, the shorter host field value is extended to the length of the cross-referenced field with non-significant characters, according to the data type, and the join is processed.
- **FOCUS reporting mode.** The JOIN command processor assures partial value equality of joined fields.
 - When joining a shorter to a longer field, a search range is created to find all cross-referenced values that are prefixed with the host value.
 - When joining a longer to a shorter field, the host value is unconditionally truncated to the cross-referenced field length. If the truncation removes non-blank characters, the match will not be done and the comparison will fail, rejecting the records.

Control the Join Mode for Record-Based Data Sources

```
SET JOIN_LENGTH_MODE | JOINLM} = {SQL | RANGE}
```

where:

SQL

Sets SQL compliant mode, which assures strict equality between host and cross-referenced field values. This is the default value.

RANGE

Sets FOCUS reporting mode, which supports partial key joins.

Data Formats of Shared Fields

Generally, the fields containing the shared values in the host and cross-referenced files must have the same data formats.

If you specify multiple host file fields, the JOIN command treats the fields as one concatenated field. Add the field format lengths to obtain the length of the concatenated field. You must observe the following rules:

- If the host field is alphanumeric, the cross-referenced field must also be alphanumeric and have the same length.

The formats may have different edit options.

Note that a text field cannot be used to join data sources.

- If the host field is a numeric field, the host field format, as specified by the USAGE (or FORMAT) attribute in the Master File, must agree in type (I, P, F, or D) with the format of the cross-referenced field as specified by the USAGE (or FORMAT) attribute. For details, see [Joining Fields With Different Numeric Data Types](#).

The edit options may differ. The length may also differ, but with the following effect:

- If the format of the host field (as specified by the USAGE attribute) is packed decimal (P) or integer (I) and is longer than the cross-referenced field format

(specified by the USAGE attribute for FOCUS data sources or the ACTUAL attribute for other data sources), only the length of the cross-referenced field format is compared, using only the right-most digits of the shorter field. For example, if a five-digit packed decimal format field is joined to a three-digit packed decimal format field, when a host record with a five-digit number is retrieved, all cross-referenced records with the last three digits of that number are also retrieved.

- If the format of the host field is double precision (D), the left-most eight bytes of each field are compared.
- If the host field is a date field, the cross-referenced field must also be a date field. Date and date-time fields must have the same components, not necessarily in the same order.
- The host and cross-referenced fields can be described as groups in the Master File if they contain the same number of component fields. The corresponding component fields in each group (for example, the first field in the host group and the first field in the cross-referenced group) must obey the above rules. For related information, see [Creating an Equijoin](#).

If the host field is not a group field, the cross-referenced field can still be a group. If the host field is a group, the cross-referenced field must also be a group.

Joining Fields With Different Numeric Data Types

You can join two or more data sources containing different numeric data types. For example, you can join a field with a short packed decimal format to a field with a long packed decimal format, or a field with an integer format to a field with a packed decimal format. This provides enormous flexibility for creating reports from joined data sources.

- When joining a shorter field to a longer field, the cross-referenced value is padded to the length of the host field, adding spaces (for alpha fields) or hexadecimal zeros (for numeric fields). This new value is used for searches in the cross-referenced file.
- When joining a longer field to a shorter field, the FROM value is truncated. If part of your value is truncated due to the length of the USAGE in the cross-referenced file, only records matching the truncated value will be found in the cross-referenced file.

i Note:

- For comparison on packed decimal fields to be accomplished properly, all signs for positive values are converted to hex C and all signs for negative values are converted to hex D.
- The JOINOPT parameter also corrects for lagging values in a unique join. For information, see [Correct for Lagging Values With a Unique Join](#).

Enable Joins With Data Type Conversion

To enable joins with data type conversion, issue the command

```
SET JOINOPT = [GNTINT|OLD]
```

where:

GNTINT

Enables joins with data type conversion.

OLD

Disables joins with data type conversion. This value is the default.

Issuing Joins With Data Type Conversion

Since you can join a field with a short packed decimal format to a field with a long packed decimal format, a join can be defined in the following Master Files:

```
FILE=PACKED,SUFFIX=FIX,$
  SEGNAME=ONE,SEGTYPE=S0
  FIELD=FIRST,,P8,P4,INDEX=I,$
```

```
FILE=PACKED2,SUFFIX=FIX,$
  SEGNAME=ONE,SEGTYPE=S0
  FIELD=PFIRST,,P31,P16,INDEX=I,$
```

The JOIN command might look like this:

```
JOIN FIRST IN PACKED TO ALL PFIRST IN PACKED2 AS J1
```

When joining packed fields, the preferred sign format of X'C' for positive values and X'D' for negative values is still required. All other non-preferred signs are converted to either X'C' or X'D'.

Using a Conditional Join

Using conditional JOIN syntax, you can establish joins based on conditions other than equality between fields. In addition, the host and cross-referenced join fields do not have to contain matching formats, and the cross-referenced field does not have to be indexed.

The conditional join is supported for FOCUS and for VSAM, ADABAS, IMS, IDMS, and all relational data sources. Because each data source differs in its ability to handle complex WHERE criteria, the optimization of the conditional JOIN syntax differs depending on the specific data sources involved in the join and the complexity of the WHERE criteria.

The standard ? JOIN command lists every join currently in effect, and indicates any that are based on WHERE criteria.

Create a Conditional JOIN

The syntax of the conditional (WHERE-based) JOIN command is

```
JOIN [LEFT_OUTER|RIGHT_OUTER|INNER] FILE hostfile AT hfld1      [WITH
hfld2] [TAG tag1]
      TO {UNIQUE|MULTIPLE}
      FILE crfile AT crfld [TAG tag2] [AS joinname]
      [WHERE expression1;
      [WHERE expression2;
      ...]
END
```

where:

INNER

Specifies an inner join. If you do not specify the type of join in the JOIN command, the ALL parameter setting determines the type of join to perform.

LEFT_OUTER

Specifies a left outer join. If you do not specify the type of join in the JOIN command, the ALL parameter setting determines the type of join to perform.

RIGHT_OUTER

Specifies a right outer join. The command SET SHORTPATH = SQL must be in effect.

hostfile

Is the host Master File.

AT

Links the correct parent segment or host to the correct child or cross-referenced segment. The field values used as the AT parameter are not used to cause the link. They are simply used as segment references.

hfld1

Is a field name in the host Master File whose segment will be joined to the cross-referenced data source. The field name must be at the lowest level segment in its data source that is referenced.

tag1

Is the optional tag name of up to 66 characters that is used as a unique qualifier for fields and aliases in the host data source.

hfld2

Is a data source field with which to associate a DEFINE-based conditional JOIN. For a DEFINE-based conditional join, the KEEPDEFINES setting must be ON or ALL, and you must create the virtual fields before issuing the JOIN command.

MULTIPLE

Specifies a one-to-many relationship between *hostfile* and *crfile*. Note that ALL is a synonym for MULTIPLE.

UNIQUE

Specifies a one-to-one relationship between *hostfile* and *crfile*. Note that ONE is a synonym for UNIQUE.

i Note: Regardless of the character of the JOIN—INNER or LEFT_OUTER—the join to UNIQUE will return only one instance of the cross-referenced file, and if this instance does not match based on the evaluation of the WHERE expression, default values (spaces for alphanumeric fields and 0 for numerical fields) are returned. There are never short paths or missing values in the cross-referenced file.

crfile

Is the cross-referenced Master File.

crfld

Is a field name in the cross-referenced Master File. It can be any field in the segment.

tag2

Is the optional tag name of up to 66 characters that is used as a unique qualifier for fields and aliases in the cross-referenced data source.

joinname

Is the name associated with the joined structure.

expression1, expression2

Are any expressions that are acceptable in a DEFINE FILE command. All fields used in the expressions must lie on a single path.

You must include the connection between the tables in the WHERE conditions. The AT references do not actually perform a JOIN between the fields as with a standard JOIN.

If you do not include any WHERE conditions in the join, a cartesian product is generated.

END

The END command is required to terminate the command and must be on a line by itself.

i Note: Single line JOIN syntax is not supported.

Using a Conditional Join

The following example joins the VIDEOTRK and MOVIES data sources on the conditions that:

- The transaction date (in VIDEOTRK) is more than ten years after the release date (in MOVIES).
- The movie codes match in both data sources.

The join is performed at the segment that contains MOVIECODE in the VIDEOTRK data source, because the join must occur at the lowest segment referenced.

The following request displays the title, most recent transaction date, and release date for each movie in the join, and computes the number of years between this transaction date and the release date:

```
JOIN FILE VIDEOTRK AT MOVIECODE TAG V1 TO ALL
      FILE MOVIES   AT RELDATE   TAG M1 AS JW1
      WHERE DATEDIF(RELDATE, TRANSDATE, 'Y') GT 10;
      WHERE V1.MOVIECODE EQ M1.MOVIECODE;
END
TABLE FILE VIDEOTRK
  SUM TITLE/A25 AS 'Title'
      TRANSDATE AS 'Last,Transaction'
      RELDATE AS 'Release,Date'
  COMPUTE YEARS/I5 = (TRANSDATE - RELDATE)/365; AS 'Years,Difference'
  BY TITLE NOPRINT
  BY HIGHEST 1 TRANSDATE NOPRINT
END
```

The output is:

Title	Last Transaction	Release Date	Years Difference
-----	-----	-----	-----
ALICE IN WONDERLAND	91/06/22	51/07/21	39
ALIEN	91/06/18	80/04/04	11
ALL THAT JAZZ	91/06/25	80/05/11	11
ANNIE HALL	91/06/24	78/04/16	13

BAMBI	91/06/22	42/07/03	49
BIRDS, THE	91/06/23	63/09/27	27
CABARET	91/06/25	73/07/14	17
CASABLANCA	91/06/27	42/03/28	49
CITIZEN KANE	91/06/22	41/08/11	49
CYRANO DE BERGERAC	91/06/20	50/11/09	40
DEATH IN VENICE	91/06/26	73/07/27	17
DOG DAY AFTERNOON	91/06/23	76/04/04	15
EAST OF EDEN	91/06/20	55/01/12	36
GONE WITH THE WIND	91/06/24	39/06/04	52
JAWS	91/06/27	78/05/13	13
MALTESE FALCON, THE	91/06/19	41/11/14	49
MARTY	91/06/19	55/10/26	35
NORTH BY NORTHWEST	91/06/21	59/02/09	32
ON THE WATERFRONT	91/06/24	54/07/06	36
PHILADELPHIA STORY, THE	91/06/21	40/05/06	51
PSYCHO	91/06/17	60/05/16	31
REAR WINDOW	91/06/17	54/12/15	36
SHAGGY DOG, THE	91/06/25	59/01/09	32
SLEEPING BEAUTY	91/06/24	75/08/30	15
TIN DRUM, THE	91/06/17	80/03/01	11
VERTIGO	91/06/27	58/11/25	32

Full Outer Joins

The FOCUS join command and conditional join command have a FULL OUTER join option.

A full outer join returns all rows from the source data source and all rows from the target data source. Where values do not exist for the rows in either data source, null values are returned. FOCUS substitutes default values on the report output (blanks for alphanumeric columns, the NODATA symbol for numeric columns).

Full outer joins and right outer joins are supported whether or not the underlying data source supports them. When the underlying data source has support for these joins, the join processing is passed to the database engine. When it does not support them, all necessary data is returned and the join processing is handled by FOCUS.



Note: The command SET SHORTPATH = SQL must be in effect in order to issue a full outer join.

Specify a Full Outer Join

The following syntax generates a full outer equijoin based on real fields:

```
JOIN FULL_OUTER hfld1 [AND hfld2 ...] IN table1 [TAG tag1] TO  
{UNIQUE|MULTIPLE} crfld [AND crfld2 ...] IN table2 [TAG tag2] [AS  
joinname]  
END
```

where:

hfld1

Is the name of a field in the host table containing values shared with a field in the cross-referenced table. This field is called the host field.

AND hfld2...

Can be an additional field in the host table. The phrase beginning with AND is required when specifying multiple fields.

- For relational adapters that support multi-field and concatenated joins, you can specify up to 20 fields. See your adapter documentation for specific information about supported join features.

IN table1

Is the name of the host table.

TAG tag1

Is a tag name of up to 66 characters (usually the name of the Master File), which is used as a unique qualifier for fields and aliases in the host table.

The tag name for the host table must be the same in all the JOIN commands of a joined structure.

TO [UNIQUE|MULTIPLE] crfld1

Is the name of a field in the cross-referenced table containing values that match those of *hfld1* (or of concatenated host fields). This field is called the cross-referenced field.



Note: UNIQUE returns only one instance and, if there is no matching instance in the cross-referenced table, it returns null values.

Use the `MULTIPLE` parameter when *crfld1* may have multiple instances in common with one value in *hfld1*. Note that `ALL` is a synonym for `MULTIPLE`, and omitting this parameter entirely is a synonym for `UNIQUE`.

AND crfld2...

Is the name of a field in the cross-referenced table with values in common with *hfld2*.

i Note: *crfld2* may be qualified. This field is only available for adapters that support multi-field joins.

IN crfile

Is the name of the cross-referenced table.

TAG tag2

Is a tag name of up to 66 characters (usually the name of the Master File), which is used as a unique qualifier for fields and aliases in cross-referenced tables. In a recursive join structure, if no tag name is provided, all field names and aliases are prefixed with the first four characters of the join name.

The tag name for the host table must be the same in all the `JOIN` commands of a joined structure.

AS joinname

Is an optional name of up to eight characters that you may assign to the join structure. You must assign a unique name to a join structure if:

- You want to ensure that a subsequent `JOIN` command does not overwrite it.
- You want to clear it selectively later.
- The structure is recursive.

i Note: If you do not assign a name to the join structure with the `AS` phrase, the name is assumed to be blank. A join without a name overwrites an existing join without a name.

END

Required when the JOIN command is longer than one line. It terminates the command and must be on a line by itself.

The following syntax generates a DEFINE-based full outer join:

```
JOIN FULL OUTER deffld WITH host_field ...
    IN table1 [TAG tag1]
    TO [UNIQUE|MULTIPLE]
    cr_field IN table2 [TAG tag2] [AS joinname]
END
```

where:

deffld

Is the name of a virtual field for the host file (the host field). The virtual field can be defined in the Master File or with a DEFINE command.

WITH host_field

Is the name of any real field in the host segment with which you want to associate the virtual field. This association is required to locate the virtual field.

The WITH phrase is required unless the KEEPDEFINES parameter is set to ON or ALL and *deffld* was defined prior to issuing the JOIN command.

To determine which segment contains the virtual field, use the ? DEFINE query after issuing the DEFINE command.

IN table1

Is the name of the host table.

TAG tag1

Is a tag name of up to 66 characters (usually the name of the Master File), which is used as a unique qualifier for fields and aliases in host tables.

The tag name for the host table must be the same in all JOIN commands of a joined structure.

TO [UNIQUE|MULTIPLE] crfld1

Is the name of a real field in the cross-referenced table whose values match those of the virtual field. This must be a real field declared in the Master File.

i Note: UNIQUE returns only one instance and, if there is no matching instance in the cross-referenced table, it returns null values.

Use the MULTIPLE parameter when *crfld1* may have multiple instances in common with one value in *hfld1*. Note that ALL is a synonym for MULTIPLE, and omitting this parameter entirely is a synonym for UNIQUE.

IN crfile

Is the name of the cross-referenced table.

TAG tag2

Is a tag name of up to 66 characters (usually the name of the Master File), which is used as a unique qualifier for fields and aliases in cross-referenced tables. In a recursive joined structure, if no tag name is provided, all field names and aliases are prefixed with the first four characters of the join name.

The tag name for the host file must be the same in all JOIN commands of a joined structure.

AS joinname

Is an optional name of up to eight characters that you may assign to the joined structure. You must assign a unique name to a join structure if:

- You want to ensure that a subsequent JOIN command does not overwrite it.
- You want to clear it selectively later.
- The structure is recursive, and you do not specify tag names.

If you do not assign a name to the joined structure with the AS phrase, the name is assumed to be blank. A join without a name overwrites an existing join without a name.

END

Required when the JOIN command is longer than one line. It terminates the command and must be on a line by itself.

The following syntax generates a full outer conditional join:

```

JOIN FULL_OUTER FILE table1 AT hfld1 [WITH hfld2] [TAG tag1]
  TO {UNIQUE|MULTIPLE}
  FILE table2 AT crfld [TAG tag2] [AS joinname]
  [WHERE expression1;
  [WHERE expression2;
  ...]
END

```

where:

table1

Is the host Master File.

AT

Links the correct parent segment or host to the correct child or cross-referenced segment. The field values used as the AT parameter are not used to cause the link. They are used as segment references.

hfld1

Is the field name in the host Master File whose segment will be joined to the cross-referenced table. The field name must be at the lowest level segment in its data source that is referenced.

tag1

Is the optional tag name that is used as a unique qualifier for fields and aliases in the host table.

hfld2

Is a table column with which to associate a DEFINE-based conditional JOIN. For a DEFINE-based conditional join, the KEEPDEFINES setting must be ON or ALL, and you must create the virtual fields before issuing the JOIN command.

MULTIPLE

Specifies a one-to-many relationship between *table1* and *table2*. Note that ALL is a synonym for MULTIPLE.

UNIQUE

Specifies a one-to-one relationship between *table1* and *table2*. Note that ONE is a synonym for UNIQUE.

i Note: The join to UNIQUE will return only one instance of the cross-referenced table, and if this instance does not match based on the evaluation of the WHERE expression, null values are returned.

crfile

Is the cross-referenced Master File.

crfld

Is the join field name in the cross-referenced Master File. It can be any field in the segment.

tag2

Is the optional tag name that is used as a unique qualifier for fields and aliases in the cross-referenced table.

joinname

Is the name associated with the joined structure.

expression1, expression2

Are any expressions that are acceptable in a DEFINE FILE command. All fields used in the expressions must lie on a single path.

END

The END command is required to terminate the command and must be on a line by itself.

Optimizing a Full Outer Join of Db2 Tables

The following requests generate two Db2 tables to join, and then issues a request against the join.

The following request generates the WF_SALES table. The field ID_PRODUCT will be used in the full outer join command. The generated table will contain ID_PRODUCT values from 2150 to 4000:

```
TABLE FILE WFLITE
SUM GROSS_PROFIT_US PRODUCT_CATEGORY PRODUCT_SUBCATEG
```

```

BY ID_PRODUCT
WHERE ID_PRODUCT FROM 2150 TO 4000
ON TABLE HOLD AS WF_SALES FORMAT DB2
END

```

The following request generates the WF_PROD table. The field ID_PRODUCT will be used in the full outer join command. The generated table will contain ID_PRODUCT values from 3000 to 5000:

```

TABLE FILE WFLITE
SUM PRICE_DOLLARS PRODUCT_CATEGORY PRODUCT_SUBCATEG PRODUCT_NAME
BY ID_PRODUCT
WHERE ID_PRODUCT FROM 3000 TO 5000
ON TABLE HOLD AS WF_PROD FORMAT DB2
END

```

The following request issues the SET SHORTPATH = SQL and JOIN commands and displays values from the joined tables:

```

SET SHORTPATH = SQL
SET TRACEUSER=ON
SET TRACESTAMP=OFF
SET TRACEOFF=ALL
SET TRACEON = STMTRACE//CLIENT
JOIN FULL OUTER ID_PRODUCT IN WF_PROD TAG T1
  TO ALL ID_PRODUCT IN WF_SALES TAG T2
END
TABLE FILE WF_PROD
PRINT T1.ID_PRODUCT AS 'Product ID'
PRICE_DOLLARS AS Price
T2.ID_PRODUCT AS 'Sales ID'
GROSS_PROFIT_US
BY T1.ID_PRODUCT NOPRINT
ON TABLE SET PAGE NOPAGE
ON TABLE SET STYLE *
GRID=OFF,$
ENDSTYLE
END

```

The trace shows that the full outer join was optimized (translated to SQL) so that SQL Server could process the join:

```

SELECT
T1."ID_PRODUCT",
T1."PRICE_DOLLARS",
T2."ID_PRODUCT",
T2."GROSS_PROFIT_US"
FROM
( WF_PROD T1
FULL OUTER JOIN
WF_SALES T2
ON T2."ID_PRODUCT" = T1."ID_PRODUCT" )
ORDER BY
T1."ID_PRODUCT";

```

The output has a row for each ID_PRODUCT value that is in either table. Rows with ID_PRODUCT values from 2150 to 2167 are only in the WF_SALES table, so the columns from WF_PROD display the NODATA symbol. Rows with ID_PRODUCT values above 4000 are only in the WF_PROD table, so the columns from WF_SALES display the NODATA symbol. Rows with ID_PRODUCT values from 2000 to 4000 are in both tables, so all columns have values, as shown in the following image.

Product ID	Price	Sales ID	Gross Profit
.	.	2151	\$7,172.24
.	.	2152	\$6,766.45
.	.	2153	\$7,291.10
.	.	2154	\$19,913.65
.	.	2155	\$12,472.93
.	.	2156	\$14,484.75
.	.	2157	\$6,223.34
.	.	2158	\$11,267.75
.	.	2159	\$9,015.75
.	.	2160	\$7,194.15
.	.	2161	\$8,683.00
.	.	2162	\$9,197.81
.	.	2163	\$21,347.98
.	.	2164	\$5,615.33
.	.	2165	\$8,540.53
.	.	2166	\$12,469.45
.	.	2167	\$6,771.26
3001	47,988.00	3001	\$12,786.30
3002	34,990.00	3002	\$5,586.10
3003	30,591.00	3003	\$12,399.15
3004	44,187.00	3004	\$8,434.95
3005	30,057.00	3005	\$8,987.80
3006	25,348.05	3006	\$6,422.59
3007	23,607.00	3007	\$8,354.60
3008	42,898.57	3008	\$18,469.01
3009	48,139.00	3009	\$22,542.75
3010	44,850.00	3010	\$16,722.15
3011	28,078.44	3011	\$18,204.82
3012	31,146.00	3012	\$19,739.45
3013	27,208.00	3013	\$17,983.00
3014	23,968.59	3014	\$19,996.09
3015	29,061.45	3015	\$17,420.72
4012	43,998.35	.	.
4013	24,749.89	.	.
4014	33,966.00	.	.
4015	20,998.95	.	.
4016	32,899.06	.	.

Reporting Against a Multi-Fact Cluster Synonym

A cluster synonym is a synonym in which each segment is added to the cluster by reference using a CRFILE attribute that points to the base synonym. Child segments are joined to their parents using a JOIN WHERE attribute. A cluster Master File can have multiple root segments. In this case, the root segments are usually fact tables and the child segments are usually dimension tables, as found in a star schema. This type of structure is called a multi-fact cluster.

A dimension table can be a child of multiple fact tables (called a shared dimension) or be a child of a single fact table (called a non-shared dimension). In most cases, the fact tables are used for aggregation and the dimension tables are used for sorting.

The following image shows a simple multi-fact structure.

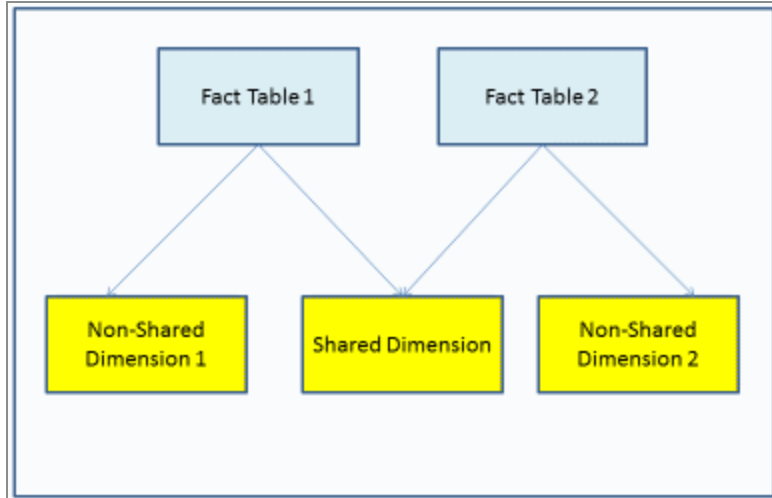

For information about creating a multi-fact cluster Master File, see the *ibi™ FOCUS® Describing Data* manual.

The following list shows the rules for creating a report request against a multi-fact cluster Master File.

- You can report against only the fact tables, as long as you aggregate (SUM) at least one fact from each fact table and have at most one sort phrase.
- The first sort field in the request must be from a shared dimension.
- Any number of shared dimensions can be referenced in the request.
- Multiple non-shared dimensions can be included in the request, as long as they have the same parent. More than one non-shared dimension from different parents cannot

be referenced in a request.

- The MATCH FILE command is not supported for reporting against a multi-fact synonym.
- The MODIFY command is not supported against a multi-fact synonym.

Reporting Against a Multi-Fact Cluster Synonym

The following request against the WFLITE multi-fact cluster synonym sums the COGS_US measure from the WF_RETAIL_SALES segment and the DAYSDELAYED measure from the WF_RETAIL_SHIPMENTS segment. The first BY field, BRAND, is in the shared dimension WF_RETAIL_PRODUCT. The second BY field, TIME_QTR, is from the non-shared dimension WF_RETAIL_TIME_DELIVERED.

```
TABLE FILE WFLITE
SUM COGS_US DAYSDELAYED
BY BRAND
BY WF_RETAIL_TIME_DELIVERED.TIME_QTR
WHERE BRAND EQ 'Denon' OR 'Grado'
WHERE DAYSDELAYED GT 1
ON TABLE SET PAGE NOLEAD
ON TABLE SET STYLE *
INCLUDE=IBFS:/FILE/IBI_HTML_DIR/ibi_themes/Warm.sty,$
END
```

The output is shown in the following image. The sum of DAYSDELAYED is totaled for each value of the shared dimension and, within each value of the shared dimension, for each value of the non-shared dimension.

Brand	Cost of Goods	Quarter	Days Delayed
Denon	\$25,970.00		12
		1	3
		2	4
		3	5
Grado	\$21,930.00		5
		2	5

Adding a New Fact To Multi-Fact Synonyms: JOIN AS_ROOT

The JOIN AS_ROOT command adds a new fact table as an additional root to an existing fact-based cluster (star schema). The source Master File has a parent fact segment and at least one child dimension segment. The JOIN AS_ROOT command supports a unique join from a child dimension segment (at any level) to an additional fact parent.

Add an Additional Parent Segment

```
JOIN AS_ROOT sfld1 [AND sfld2 ...] IN [app1/]sfile TO UNIQUE tfld1 [AND  
tfld2 ...] IN [app2/]tfile AS jname  
END
```

where:

sfld1 [AND sfld2 ...]

Are fields in the child (dimension) segment of the source file that match values of fields in the target file.

[app1/]sfile

Is the source file.

TO UNIQUE tfld1 [AND tfld2 ...]

Are fields in the target file that match values of fields in the child segment of the source file. The join must be unique.

[app2/]tfile

Is the target file.

jname

Is the join name.

END

Is required to end the JOIN command.

Joining AS_ROOT From the WebFOCUS Retail Data Source to a Db2 Table

The following request joins the product category and product subcategory fields in the WebFOCUS Retail data source to a Db2 table named PROJECTD.

Create Tutorial Framework

Tutorial	WebFOCUS - Retail Demo
Select DBMS:	MS SQL Server
Select Connection:	wf_retail
Prefix for SQL Tables	wrd wrd or mylib/wrd or xxx.wrd
Data Security (DBA)	None
<input checked="" type="checkbox"/> Limit Tutorial Data (from 285M to 9M)	
Application	wfretail

Create

The Master File for the Db2 table is:

	A	B	C	D
	Product	Product		Projected
1	Category	Subcategory	Projected COG	Sale Units
2	Accessories	Charger	\$2,068,508.00	75,279
3	Accessories	Headphones	\$52,061,301.00	163,152
4	Accessories	Universal Remote Controls	\$36,297,267.00	127,286
5	Camcorder	Handheld	\$20,733,053.00	178,704
6	Camcorder	Professional	\$35,440,708.00	9,095
7	Camcorder	Standard	\$49,442,067.00	137,489
8	Computers	Smartphone	\$44,420,201.00	146,858
9	Computers	Tablet	\$26,047,885.00	105,053
10	Media Player	Blu Ray	\$182,459,862.00	485,131
11	Media Player	DVD Players	\$3,756,254.00	13,346
12	Media Player	DVD Players - Portable	\$306,576.00	3,981
13	Media Player	Streaming	\$5,108,342.00	48,630
14	Stereo Systems	Boom Box	\$840,373.00	6,687
15	Stereo Systems	Home Theater Systems	\$56,829,817.00	285,041
16	Stereo Systems	Receivers	\$40,620,030.00	107,537
17	Stereo Systems	Speaker Kits	\$81,962,756.00	174,036
18	Stereo Systems	iPod Docking Station	\$26,310,783.00	221,723
19	Televisions	CRT TV	\$1,928,416.00	3,268
20	Televisions	Flat Panel TV	\$59,540,624.00	66,119
21	Televisions	Portable TV	\$545,348.00	5,696
22	Video Production	Video Editing	\$40,380,803.00	142,594

The Master File for the PROJECTD table is:

```

FILENAME=PROJDB2 , SUFFIX=DB2 , $
SEGMENT=SEG01, SEGTYPE=S0, $
FIELDNAME=PRODUCT_CATEGORY, ALIAS='Product Category', USAGE=A16,
ACTUAL=A16, MISSING=ON, TITLE='Product Category',
WITHIN='*PRODUCT', $
FIELDNAME=PRODUCT_SUBCATEGORY, ALIAS='Product
Subcategory', USAGE=A25,
ACTUAL=A25, MISSING=ON, TITLE='Product Subcategory',
WITHIN=PRODUCT_CATEGORY, $
FIELDNAME=PROJECTED_COG, ALIAS=' Projected COG', USAGE=D12,
ACTUAL=D8, MISSING=ON,
TITLE=' Projected COG', MEASURE_GROUP=PROJECTED,
PROPERTY=MEASURE, $
FIELDNAME=PROJECTED_SALE_UNITS, ALIAS=' Projected Sale.Units',
USAGE=I9, ACTUAL=I4, MISSING=ON,
TITLE=' Projected Sale Units', MEASURE_GROUP=PROJECTED,
PROPERTY=MEASURE, $
DIMENSION=PRODUCT, CAPTION='Product', $

```

```
HIERARCHY=PRODUCT, CAPTION='Product', HRY_DIMENSION=PRODUCT, $
MEASUREGROUP=PROJECTED, $
```

The following image shows the data in the PROJECTD table.

Product Category	Product Subcategory	Projected COG	Projected Sale_
Units			
-----	-----	-----	-----
-			
Accessories 75279	Charger	2,068,508	
Accessories 163152	Headphones	52,061,301	
Accessories 127286	Universal Remote Controls	36,297,267	
Camcorder 178704	Handheld	20,733,053	
Camcorder 9095	Professional	35,440,708	
Camcorder 137489	Standard	49,442,067	
Computers 146858	Smartphone	44,420,201	
Computers 105053	Tablet	26,047,885	
Media Player 485131	Blu Ray	182,459,862	
Media Player 13346	DVD Players	3,756,254	
Media Player 3981	DVD Players - Portable	306,576	
Media Player 48630	Streaming	5,108,342	
Stereo Systems 221723	iPod Docking Station	26,310,783	
Stereo Systems 6687	Boom Box	840,373	
Stereo Systems 285041	Home Theater Systems	56,829,817	
Stereo Systems 107537	Receivers	40,620,030	
Stereo Systems 174036	Speaker Kits	81,962,756	
Televisions 3268	CRT TV	1,928,416	

Televisions 66119	Flat Panel TV	59,540,624
Televisions 5696	Portable TV	545,348
Video Production 142594	Video Editing	40,380,803

The following request joins from the wf_retail_product segment of the WFLITE data source to the Db2 table as a new root and reports from both parent segments:

```
JOIN AS_ROOT PRODUCT_CATEGORY AND PRODUCT_SUBCATEG IN WFLITE
  TO UNIQUE PRODUCT_CATEGORY AND PRODUCT_SUBCATEGORY IN PROJECTD
  AS J1
END
TABLE FILE WFLITE
SUM PROJECTED_SALE_UNITS REVENUE_US
BY PRODUCT_CATEGORY
ON TABLE SET PAGE NOPAGE
END
```

The output is:

Product Category	Projected Sale Units	Revenue
Accessories	365717	\$41,817.34
Camcorder	325288	\$49,768.33
Computers	251911	\$18,298.75
Media Player	551088	\$118,615.17
Stereo Systems	795024	\$111,768.71
Televisions	75083	\$27,209.29
Video Production	142594	\$25,837.37

Product Category	Projected Sale Units	Revenue
-----	-----	-----
Accessories	365717	\$499,551.40
Camcorder	325288	\$667,254.48
Computers	251911	\$179,761.46
Media Player	551088	\$1,009,790.56

Stereo Systems	795024	\$1,216,393.89
Televisions	75083	\$286,160.68
Video Production	142594	\$259,179.84

Generating Outer Joins of Cluster Synonym Contexts

Reporting against multiple root segments and a shared dimension generates multiple contexts in a cluster synonym. For example, in the following image Sales and Products form one context, while Shipments and Products form a second context.

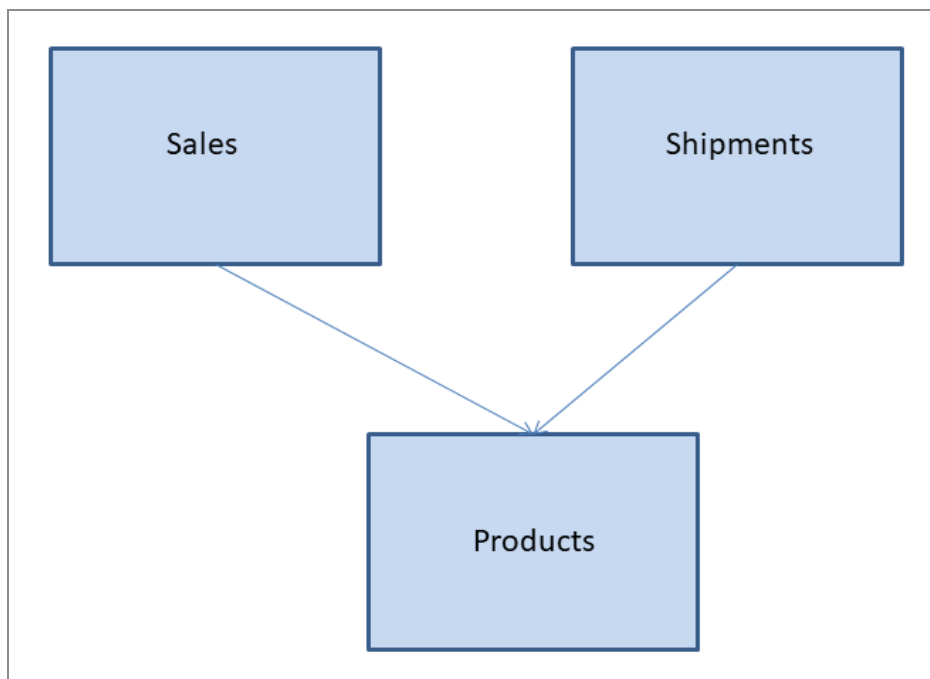

When a request contains fields from both contexts, by default, an inner join is passed to the SQL engine. This retrieves only matching values of the shared dimension fields from both contexts.

You can use the `BLEND-MODE` parameter to generate a full outer join instead of an inner join and retrieve all values from both contexts.

Control Join Processing of Cluster Synonym Contexts

The screenshot shows a configuration window with two main sections:

- Customize data type mappings:**
 - DECOMPOSE-DATE: On (Decompose Date fields into components)
 - DATEFMT: Adapter specific default (Date Order)
 - GEORoles-AUTO: On (Activate GEOGRAPHIC_ROLE assignment)
 - CONV_NUM_FLOAT: On (Set data type DOUBLE for numeric decimal columns)
 - CONV_CHAR_VAR: On (Set data type AnV for character columns)
- Request transformation settings:**
 - GEO_UNIFIED_ROLE: On (Compatibility with the previously shipped releases)
 - GEO_MAP_PROVIDER: Esri and WFRS MBR (Map providers (Requires GEO_UNIFIED_ROLE set to ON))
 - GEO_ALIASING: On (Enables aliasing to map administrative entities)
 - GEO_ALIASING_APP: DEFAULT (Application for user added csv files with aliases. Default: DEFAULT)
 - GEO_ALIASING_FIPS: On (Enables FIPS aliasing to map administrative entities)
 - GEO_COUNTRY: United States (Default value for automatically added country virtual field. Default: United States)
 - GEOROLE_2_MBRLEVEL: Enable customized per country mapping (Enable customized per country mapping of geo roles to MB adminis)
 - FCA: Disables the multiplicative effect analysis (Activate Foctransform Context Analysis)
 - BLEND-MODE: Select all values (Mode for processing blended structures)
 - FCA-HOLD: Select only common values (Best to output SQL Script) (Mode for producing different HOLD formats)
 - MFACT-OUTPUT: Select all values (Information Output Type)

A 'Save' button is located at the bottom left of the configuration area.

You can use the following syntax to set the blend mode parameter.

```
ENGINE INT SET BLEND-MODE {COMMON-VALUES|ALL-VALUES}
```

where:

COMMON-VALUES

Generates an inner join of cluster synonym contexts and returns only matching values of the shared dimension fields. This is the default value.

ALL-VALUES

Generates a full outer join of cluster synonym contexts and returns all values of the shared dimension fields. Missing values are returned for fields from contexts that do not have a matching value of the shared dimension fields.

Joining From a Multi-Fact Synonym

Multi-parent synonyms are now supported as the source for a join to a single segment in a target synonym.

A join from a multi-parent synonym is subject to the following conditions:

- Conditional joins are not supported (JOIN WHERE).
- The join must be unique. That is, the TO ALL or TO MULTIPLE phrase is not supported.
- The target of the join cannot be a multi-parent synonym.
- The target of the JOIN must be a single segment, either in a single segment synonym or one segment in a single parent, multi-segment synonym.
- All fields in the JOIN must be FROM/TO a single segment. Any single segment in the source synonym can be used in the join.

Joining From a Multi-Fact Synonym

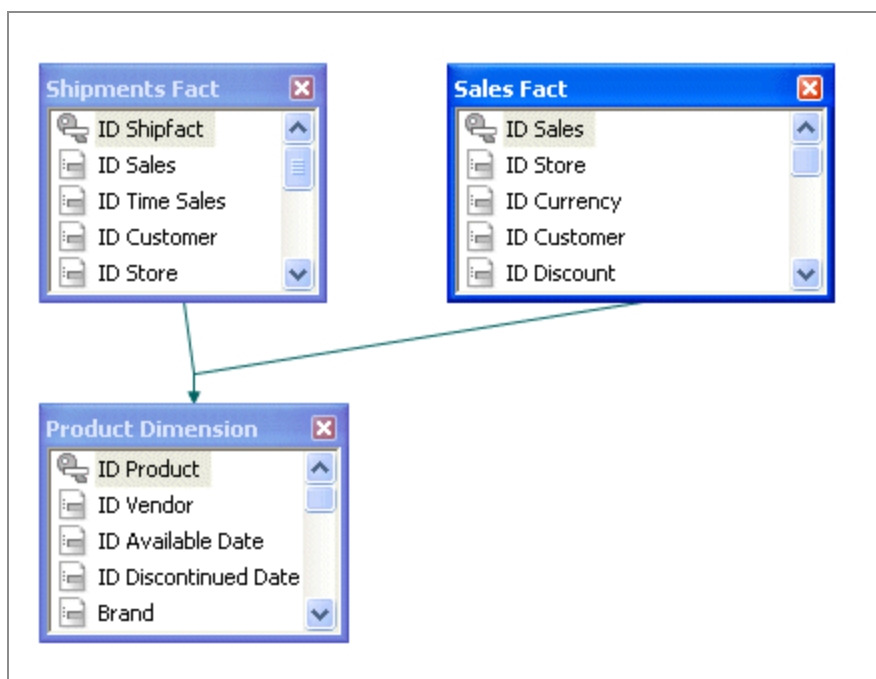

Product Category	Vendor Name	Cost of Goods	Days Delayed
Accessories	Audio Technica	\$38,000.00	28
	Denon	\$25,970.00	17
	Grado	\$21,930.00	15
	Logitech	\$61,432.00	114
	Niles Audio	\$73,547.00	150
	Pioneer	\$16,720.00	71
	Samsung	\$5,405.00	83
	Sennheiser	\$78,113.00	128
	Sony	\$21,760.00	157
Camcorder	Canon	\$110,219.00	97
	JVC	\$72,292.00	75
	Panasonic	\$22,356.00	91
	Sanyo	\$31,590.00	179
	Sony	\$216,748.00	333
Computers	Samsung	\$33,129.00	156
	Sony	\$76,152.00	186
Media Player	JVC	\$87,057.00	267
	LG	\$3,830.00	13
	Panasonic	\$143,600.00	171
	Pioneer	\$169,810.00	206
	Roku	\$10,248.00	85
	Samsung	\$151,620.00	191
	Sharp	\$66,024.00	157
	Sony	\$142,190.00	121
	Toshiba	\$5,214.00	7

The following Master File describes a multi-parent structure. The two fact tables sales and wf_retail_shipments are parents of the dimension table product.

```

FILENAME=WFMULTI, $
  SEGMENT=WF_RETAIL_SHIPMENTS, CRFILE=SHIPMENT, CRINCLUDE=ALL,
    DESCRIPTION='Shipments Fact', $
  SEGMENT=WF_RETAIL_SALES, PARENT=., CRFILE=SALES, CRINCLUDE=ALL,
    DESCRIPTION='Sales Fact', $
  SEGMENT=WF_RETAIL_PRODUCT, CRFILE=PRODUCT, CRINCLUDE=ALL,

```

```

DESCRIPTION='Product Dimension', $
PARENT=WF_RETAIL_SHIPMENTS, SEGTYPE=KU,
JOIN_WHERE=WF_RETAIL_SHIPMENTS.ID_PRODUCT EQ WF_RETAIL_PRODUCT.ID_
PRODUCT;; $
PARENT=WF_RETAIL_SALES, SEGTYPE=KU,
JOIN_WHERE=WF_RETAIL_SALES.ID_PRODUCT EQ WF_RETAIL_PRODUCT.ID_
PRODUCT;; $

```

The following request joins the product segment to the dimension table vendor based on the vendor ID and issues a request against the joined structure:

```

JOIN ID_VENDOR IN WFMULTI TO ID_VENDOR IN VENDOR AS J1
TABLE FILE WFMULTI
SUM COGS_US DAYSDELAYED
BY PRODUCT_CATEGORY
BY VENDOR_NAME
WHERE PRODUCT_CATEGORY LT 'S'
ON TABLE SET PAGE NOPAGE
END

```

The output is:

Product Category	Vendor Name	Cost of Goods	Days Delayed
Accessories	Audio Tech	\$38,000.00	28
	Denon	\$25,970.00	17
	Grado	\$21,930.00	15
	Logitech	\$61,432.00	114
	Niles Audi	\$73,547.00	150
	Pioneer	\$16,720.00	71
	Samsung	\$5,405.00	83
	Sennheiser	\$78,113.00	128
	Sony	\$21,760.00	157
Camcorder	Canon	\$110,219.00	97
	JVC	\$72,292.00	75
	Panasonic	\$22,356.00	91
	Sanyo	\$31,590.00	179
	Sony	\$216,748.00	333
Computers	Samsung	\$33,129.00	156
	Sony	\$76,152.00	186
Media Player	JVC	\$87,057.00	267
	LG	\$3,830.00	13
	Panasonic	\$143,600.00	171
	Pioneer	\$169,810.00	206

Roku	\$10,248.00	85
Samsung	\$151,620.00	191
Sharp	\$66,024.00	157
Sony	\$142,190.00	121
Toshiba	\$5,214.00	7

Invoking Context Analysis for a Star Schema With a Fan Trap

When a star schema contains a segment with aggregated facts and a lower-level segment with the related detail-level facts, a request that performs aggregation on both levels and returns them sorted by the higher level can experience the multiplicative effect. This means that the fact values that are already aggregated may be re-aggregated and, therefore, return multiplied values.

When the adapter detects the multiplicative effect, it turns optimization off in order to handle the request processing and circumvent the multiplicative effect. However, performance is degraded when a request is not optimized.

A new context analysis process has been introduced in this release that detects the multiplicative effect and generates SQL script commands that retrieve the correct values for each segment context. These scripts are then passed to the RDBMS as subqueries in an optimized SQL statement.

Change Settings for Common Adapter

Save settings in Profile Select edasprof

Customize data type mappings

? DECOMPOSE-DATE No Decompose Date fields into components

? DATEFMT Adapter specific default Format for Date fields

Miscellaneous settings

? FCA Yes Activate Foctransform Context Analysis

? BLEND-MODE Select only common values Mode for processing blended structures

? LITE-MODE No Simplified mode driven by configuration parameters

? ETL-TRG-DBMS Default ETL Target DBMS

Save Cancel

To activate the context analysis feature, issue the following command:

```
ENGINE INT SET FCA = ON
```

Navigating Joins Between Cluster Synonyms

By default, when joining cluster synonyms, a hierarchy of segments is constructed from all of the joined files, and the resulting hierarchy is navigated in top-to-bottom, left-to-right order.

Therefore, if a left outer join is specified from a host synonym to a cluster that has an inner join, the inner join will be performed last and may remove rows from the host file, counteracting the purpose of the left outer join. Using the SET FOCTRANSFORM = NESTED_CLUSTERS/ON command, you can force the joins in the target cluster to be performed prior to the join between the host and target synonyms. When you use this setting, SQL scripts are used to join the tables in the target cluster prior to implementing the join to the host file. The left outer join will be performed last and will retain all rows in the host synonym.

i Note: This feature is only supported in FOCUS for Distributed Systems.

The syntax is:

```
SET FOCTRANSFORM = {NESTED_CLUSTERS/OFF|NESTED_CLUSTERS/ON}
```

where:

NESTED_CLUSTERS/OFF

Maintains the left-to-right, top-to-bottom order of segment navigation. This is the default value.

NESTED_CLUSTERS/ON

Performs the joins in the target cluster synonym prior to joining the host synonym to the result.

Usage Notes for Joins to Cluster Synonyms

- Using the SET FOCTRANSFORM = NESTED_CLUSTERS feature requires that the joins be optimized. The command SET SHORTPATH = SQL must be in effect for combinations of inner and outer joins with the setting FOCTRANSFORM = NESTED_CLUSTERS/OFF, in order for the request to be optimized. The SHORTPATH = SQL setting has no effect on optimization with the setting FOCTRANSFORM = NESTED_CLUSTERS/ON.
- You cannot join to a non-root segment of a cluster synonym. If you issue a join to a non-root segment, the following message displays and the request terminates:

```
(FOC906) JOIN TO NON-ROOT SEGMENT segname IS NOT ALLOWED FOR  
NESTED_CLUSTERS
```

Navigating Joins Between Cluster Synonyms

This example uses SQL Server data sources generated from a file of citibike trips uploaded from <https://www.citibikenyc.com/system-data>, and from a file of zip codes for the stations used for the trips (you can download this file from https://techsupport.informationbuilders.com/public/station_zip.csv).

A cluster synonym named `station_trip_cls` joins the station zip data source to a data source containing partial trip data (with only a few rows). The following shows the inner join defined in the cluster synonym:

```
FILENAME=STATION_TRIP_CLS, $
  SEGMENT=STATION_ZIP_OLEDB, CRFILE=CITIBIKE/STATION_ZIP_OLEDB,
CRINCLUDE=ALL, $
  SEGMENT=CITIBIKE_PARTIAL_OLEDB, SEGTYPE=KU, PARENT=STATION_ZIP_OLEDB,
  CRFILE=CITIBIKE/CITIBIKE_PARTIAL_OLEDB, CRINCLUDE=ALL,
CRJOINTYPE=INNER,
  JOIN_WHERE=STATION_ID EQ START_STATION_ID;; $
```

The following request issues a left outer join from a larger version of the trip data file to the cluster:

```
SET FOCTRANSFORM = NESTED_CLUSTERS/&VALUE
SET SHORTPATH = SQL
JOIN LEFT_OUTER START_STATION_ID IN CITIBIKE_TRIPDATA TAG T1 TO ALL
STATION_ID IN STATION_TRIP_CLS TAG T2 AS J1
TABLE FILE CITIBIKE_TRIPDATA
" NESTED_CLUSTERS/&VALUE"
" "
SUM CNT.T1.START_STATION_ID AS T1,Station CNT.ZIP_CODE CNT.T2.START_
STATION_ID AS T2,Station
ON TABLE SET PAGE NOLEAD
ON TABLE SET STYLE *
GRID=OFF,$
ENDSTYLE
END
```

Running the request with `&VALUE` set to `OFF` generates the following trace:

```
SELECT
  COUNT(T1."START_STATION_ID"),
  COUNT(T2."ZIP_CODE"),
  COUNT(T3."START_STATION_ID")
FROM
  ( ( citibike_tripdata_mssqloledb T1
    LEFT OUTER JOIN
    station_zip_oledb T2
    ON T2."STATION_ID" = T1."START_STATION_ID" )
  INNER JOIN
  citibike_partial_msoledb T3
  ON (T3."START_STATION_ID" = T2."STATION_ID") );
```

The output is shown in the following image. The inner join was done last, reducing the number of stations in the host file to the same number as in the cluster.

NESTED_CLUSTERS/OFF		
T1	ZIP_CODE	T2
<u>Station</u>	<u>COUNT</u>	<u>Station</u>
165	158	165

Running the request with &VALUE set to ON generates the following trace. Two SQL scripts are generated, one for the host file and one for the join in the cluster. Then, the left outer join is performed against the result of the inner join:

```
SELECT
  T1."START_STATION_ID" AS "SK001_START_STATION_ID",
  COUNT(T1."START_STATION_ID") AS "VB001_CNT_START_STATION_ID"
  FROM
  citibike_tripdata_mssqloledb T1
  GROUP BY
  T1."START_STATION_ID";
(FOC2546) SQL SCRIPT __CITIBIKE_TRIPDATA_OLEDB_CITIBIKE_TRIPDATA_
OLEDB.SQL CREATED SUCCESSFULLY (BUT NOT EXECUTED)
_EDATEMP/__/citibike_tripdata_oledb_citibike_tripdata_oledb HELD AS
SQL_SCRIPT
SELECT
  T1."STATION_ID" AS "SK001_STATION_ID",
  COUNT(T1."ZIP_CODE") AS "VB001_CNT_ZIP_CODE",
  COUNT(T2."START_STATION_ID") AS "VB002_CNT_START_STATION_ID"
  FROM
  station_zip_oledb T1,
  citibike_partial_msoledb T2
  WHERE
  (T2."START_STATION_ID" = T1."STATION_ID")
  GROUP BY
  T1."STATION_ID";
(FOC2546) SQL SCRIPT __CITIBIKE_TRIPDATA_OLEDB_STATION_PARTIAL_OLEDB_
CLS.SQL CREATED SUCCESSFULLY (BUT NOT EXECUTED)
_EDATEMP/__/citibike_tripdata_oledb_station_partial_oledb_cls HELD AS
SQL_SCRIPT
```

```
SELECT
  SUM(T1."VB001_CNT_START_STATION_ID"),
  SUM(T2."VB001_CNT_ZIP_CODE"),
  SUM(T2."VB002_CNT_START_STATION_ID")
```

```

FROM
(
  ( /* vvv */
    SELECT
      T1."START_STATION_ID" AS "SK001_START_STATION_ID",
      COUNT(T1."START_STATION_ID") AS
      "VB001_CNT_START_STATION_ID"
    FROM
      citibike_tripdata_mssqloledb T1
    GROUP BY
      T1."START_STATION_ID"
  ) /* ^^^ */ T1
LEFT OUTER JOIN
( /* vvv */
  SELECT
    T1."STATION_ID" AS "SK001_STATION_ID",
    COUNT(T1."ZIP_CODE") AS "VB001_CNT_ZIP_CODE",
    COUNT(T2."START_STATION_ID") AS
    "VB002_CNT_START_STATION_ID"
  FROM
    station_zip_oledb T1,
    citibike_partial_msoledb T2
  WHERE
    (T2."START_STATION_ID" = T1."STATION_ID")
  GROUP BY
    T1."STATION_ID"
  ) /* ^^^ */ T2
ON T2."SK001_STATION_ID" = T1."SK001_START_STATION_ID" );

```

The output is shown in the following image. The left outer join was done last, maintaining the original number of stations in the host file.

NESTED_CLUSTERS/ON		
T1	ZIP_CODE	T2
<u>Station</u>	<u>COUNT</u>	<u>Station</u>
6680	8	9

Adding DBA Restrictions to the Join Condition: SET DBAJJOIN

When DBA restrictions are applied to a request on a multi-segment structure, by default, the restrictions are added as WHERE conditions in the report request. When the DBAJJOIN parameter is set ON, DBA restrictions are treated as internal to the file or segment for which they are specified, and are added to the join syntax.

i Note: DBA restrictions with DBAJJOIN OFF apply to the entire record instance that is being retrieved. Therefore, the entire record instance is suppressed when any part of that instance is restricted. DBAJJOIN ON applies the DBA only to the segment where the data value appears, allowing the rest of the record instance to be displayed, if applicable.

This difference is important when the file or segment being restricted has a parent in the structure and the join is an outer or unique join.

When restrictions are treated as report filters, lower-level segment instances that do not satisfy them are omitted from the report output, along with their host segments. Since host segments are omitted, the output does not reflect a true outer or unique join.

When the restrictions are treated as join conditions, lower-level values from segment instances that do not satisfy them are displayed as missing values, and the report output displays all host rows.

Add DBA Restrictions to the Join Condition

```
SET DBAJJOIN = {OFF|ON}
```

where:

OFF

Treats DBA restrictions as WHERE filters in the report request. OFF is the default value.

ON

Treats DBA restrictions as join conditions.

Using the DBAJOIN Setting With Relational Tables

The following request creates two tables, EMPINFOSQL and EDINFOSQL:

```
TABLE FILE EMPLOYEE
SUM LAST_NAME FIRST_NAME CURR_JOBCODE
BY EMP_ID
ON TABLE HOLD AS EMPINFOSQL FORMAT SQLMSS
END
-RUN
TABLE FILE EDUCFILE
SUM COURSE_CODE COURSE_NAME
BY EMP_ID
ON TABLE HOLD AS EDINFOSQL FORMAT SQLMSS
END
```

Add the following DBA attributes to the end of the generated EMPINFOSQL Master File. With the restrictions listed, USER2 cannot retrieve course codes of 300 or above:

```
END
DBA=USER1,$
USER=USER2, ACCESS = R, $
FILENAME=EDINFOSQL,$
USER=USER2, ACCESS = R, RESTRICT = VALUE, NAME=SYSTEM, VALUE=COURSE_CODE
LT 300;,$
```

Add the following DBA attributes to the end of the generated EDINFOSQL Master File:

```
END
DBA=USER1,DBAFILE=EMPINFOSQL,$
```

Issue the following request:

```
SET USER=USER2
SET DBAJOIN=OFF
JOIN LEFT_OUTER EMP_ID IN EMPINFOSQL TO MULTIPLE EMP_ID IN EDINFOSQL AS
J1
TABLE FILE EMPINFOSQL
PRINT LAST_NAME FIRST_NAME COURSE_CODE COURSE_NAME
ON TABLE SET PAGE NOPAGE
ON TABLE SET STYLE *
```

```
GRID=OFF,$
END
```

On the report output, all host and child rows with course codes 300 or above have been omitted, as shown in the following image:

<u>LAST_NAME</u>	<u>FIRST_NAME</u>	<u>COURSE_CODE</u>	<u>COURSE_NAME</u>
STEVENS	ALFRED	101	FILE DESCRPT & MAINT
SMITH	MARY	103	BASIC REPORT PREP FOR PROG
JONES	DIANE	203	FOCUS INTERNALS
SMITH	RICHARD	108	BASIC RPT NON-DP MGRS
MCKNIGHT	ROGER	101	FILE DESCRPT & MAINT

In the generated SQL the DBA restriction has been added to the WHERE predicate in the SELECT statement:

```
SELECT
  T1."EID",
  T1."LN",
  T1."FN",
  T2."CC",
  T2."CD"
  FROM
  EMPINFOSQL T1,
  EDINFOSQL T2
  WHERE
  (T2."EID" = T1."EID") AND
  (T2."CC" < '300;');
```

Rerun the request with SET DBAJJOIN=ON. The output now displays all host rows, with missing values substituted for lower-level segment instances that did not satisfy the DBA restriction, as shown on the following image:

<u>LAST_NAME</u>	<u>FIRST_NAME</u>	<u>COURSE_CODE</u>	<u>COURSE_NAME</u>
STEVENS	ALFRED	101	FILE DESCRPT & MAINT
SMITH	MARY	103	BASIC REPORT PREP FOR PROG
JONES	DIANE	203	FOCUS INTERNALS
SMITH	RICHARD	108	BASIC RPT NON-DP MGRS
BANNING	JOHN	.	.
IRVING	JOAN	.	.
ROMANS	ANTHONY	.	.
MCCOY	JOHN	.	.
BLACKWOOD	ROSEMARIE	.	.
MCKNIGHT	ROGER	101	FILE DESCRPT & MAINT
GREENSPAN	MARY	.	.
CROSS	BARBARA	.	.

In the generated SQL, the DBA restriction has been added to the join, and there is no WHERE predicate:

```
SELECT
  T1."EID",
  T1."LN",
  T1."FN",
  T2."EID",
  T2."CC",
  T2."CD"
  FROM
  ( EMPINFOSQL T1
  LEFT OUTER JOIN EDINFOSQL T2
  ON T2."EID" = T1."EID" AND
    (T2."CC" < '300;') );
```

Preserving Virtual Fields During Join Parsing

There are two ways to preserve virtual fields during join parsing. One way is to use KEEPDEFINES, and the second is to use DEFINE FILE SAVE and DEFINE FILE RETURN.

Preserving Virtual Fields Using KEEPDEFINES

The KEEPDEFINES parameter determines if a virtual field created by the DEFINE command for a host or joined structure is retained or cleared after the JOIN command is run. It

applies when the DEFINE command precedes the JOIN command.

The prior virtual fields constitute what is called a context. Each new context creates a new layer or command environment. When you first enter the new environment, all virtual fields defined in the previous layer are available in the new layer. Overwriting or clearing a virtual field definition affects only the current layer. When you return to the previous layer, its virtual field definitions are intact.

New DEFINE fields issued after the JOIN command constitute another context, and by so doing generate a stack of contexts. In each context, all virtual fields of all prior contexts are accessible.

- By default the KEEPDEFINES setting is OFF. With this setting, a JOIN command removes prior virtual fields.
- After KEEPDEFINES is set to ON, subsequent virtual fields are reinstated during the parsing of a JOIN command.
- When KEEPDEFINES is set to ALL, all subsequent virtual fields, as well as any prior virtual fields, are reinstated during the parsing of JOIN commands.

A JOIN CLEAR *as_name* command removes all the contexts that were created after the JOIN *as_name* was issued.

For DEFINE-based conditional joins, the KEEPDEFINES setting must be ON. You then must create all virtual fields before issuing the DEFINE-based conditional JOIN command. This differs from traditional DEFINE-based joins in which the virtual field is created after the JOIN command. In addition, a virtual field may be part of the JOIN syntax or WHERE syntax.

DEFINE commands issued after the JOIN command do not replace or clear the virtual fields created before the join, since a new file context is created.

Use KEEPDEFINES

```
SET KEEPDEFINES = {ON|OFF|ALL}
```

where:

ON

Retains subsequent virtual fields after a JOIN command is run.

OFF

Clears the virtual field after a JOIN command is run. OFF is the default value.

ALL

Retains all prior and subsequent virtual fields in the request after a JOIN command is run.

Usage Notes for KEEPDEFINES

- Virtual fields defined prior to setting KEEPDEFINES ON are not preserved after a JOIN command. Set KEEPDEFINES to ALL to preserve any previously defined virtual fields.
- If you are using the KEEPDEFINES command with virtual fields and nested JOINS, make sure you assign a unique name to each join structure. Adding a unique AS name to each JOIN ensures that the subsequent JOIN will not overwrite the previous JOIN or DEFINE statements.

Preserving Virtual Fields During Join Parsing With KEEPDEFINES

The first virtual field, DAYSKEPT, is defined prior to issuing any joins, but after setting KEEPDEFINES to ON. DAYSKEPT is the number of days between the return date and rental date for a videotape:

```
SET KEEPDEFINES = ON
DEFINE FILE VIDEOTRK
DAYSKEPT/I5 = RETURNDATE - TRANSDATE;
END
```

The ? DEFINE query command shows that this is the only virtual field defined at this point:

```
? DEFINE
```

FILE	FIELD NAME	FORMAT	SEGMENT	VIEW	TYPE
VIDEOTRK	DAYSKEPT	I5	4		

The following request prints all transactions in which the number of days kept is two:

```
TABLE FILE VIDEOTRK
PRINT MOVIECODE TRANSDATE RETURNDATE DAYSKEPT
COMPUTE ACTUAL_DAYS/I2 = RETURNDATE-TRANSDATE;
WHERE DAYSKEPT EQ 2
END
```

The first few lines of output show that each return date is two days after the transaction date:

MOVIECODE	TRANSDATE	RETURNDATE	DAYSKEPT	ACTUAL_DAYS
001MCA	91/06/27	91/06/29	2	2
692PAR	91/06/27	91/06/29	2	2
259MGM	91/06/19	91/06/21	2	2

Now, the VIDEOTRK data source is joined to the MOVIES data source. The ? DEFINE query shows that the join did not clear the DAYSKEPT virtual field:

```
JOIN MOVIECODE IN VIDEOTRK TO ALL MOVIECODE IN MOVIES AS J1
? DEFINE
```

FILE	FIELD NAME	FORMAT	SEGMENT	VIEW	TYPE
VIDEOTRK	DAYSKEPT	I5	4		

Next a new virtual field, YEARS, is defined for the join between VIDEOTRK and MOVIES:

```
DEFINE FILE VIDEOTRK
YEARS/I5 = (TRANSDATE - RELDATE)/365;
END
```

The ? DEFINE query shows that the virtual field created prior to the join was not cleared by this new virtual field because it was in a separate context:

```
? DEFINE
```

FILE	FIELD NAME	FORMAT	SEGMENT	VIEW	TYPE
VIDEOTRK	DAYSKEPT	I5	4		
VIDEOTRK	YEARS	I5	5		

Next, the field DAYSKEPT is re-defined so that it is the number of actual days plus one:

```
DEFINE FILE VIDEOTRK
DAYSKEPT/I5 = RETURNDATE - TRANSDATE + 1;
END
```

The ? DEFINE query shows that there are two versions of the DAYSKEPT virtual field. However, YEARS was cleared because it was in the same context (after the join) as the new version of DAYSKEPT, and the DEFINE command did not specify the ADD option:

```
? DEFINE
```

FILE	FIELD NAME	FORMAT	SEGMENT	VIEW	TYPE
VIDEOTRK	DAYSKEPT	I5	4		
VIDEOTRK	DAYSKEPT	I5	4		

The same request now uses the new definition for DAYSKEPT. Note that the number of days between the return date and transaction date is actually one day, not two because of the change in the definition of DAYSKEPT:

MOVIECODE	TRANSDATE	RETURNDATE	DAYSKEPT	ACTUAL_DAYS
040ORI	91/06/20	91/06/21	2	1
505MGM	91/06/21	91/06/22	2	1
710VES	91/06/26	91/06/27	2	1

Now, J1 is cleared. The redefinition for DAYSKEPT is also cleared:

```
JOIN CLEAR J1
? DEFINE
```

FILE	FIELD NAME	FORMAT	SEGMENT	VIEW
VIDEOTRK	DAYSKEPT	I5	4	

The report output shows that the original definition for DAYSKEPT is now in effect:

MOVIECODE	TRANSDATE	RETURNDATE	DAYSKEPT	ACTUAL_DAYS
001MCA	91/06/27	91/06/29	2	2
692PAR	91/06/27	91/06/29	2	2
259MGM	91/06/19	91/06/21	2	2

Preserving Virtual Fields Using DEFINE FILE SAVE and RETURN

The DEFINE FILE SAVE command forms a new context for virtual fields, which can then be removed with DEFINE FILE RETURN. For details, see [Creating Temporary Fields](#).

Preserving Virtual Fields With DEFINE FILE SAVE and RETURN

The following command enables you to preserve virtual fields within a file context:

```
SET KEEPDEFINES=ON
```

The following command defines the virtual field A for the VIDEOTRK data source and places it in the current context:

```
DEFINE FILE VIDEOTRK
  A/A5='JAWS';
END
```

The following command creates a new context and saves the virtual field B in this context:

```
DEFINE FILE VIDEOTRK SAVE
  B/A5='ROCKY';
END
? DEFINE
```

The output of the ? DEFINE query lists virtual fields A and B:

FILE	FIELD NAME	FORMAT	SEGMENT	VIEW	TYPE
VIDEOTRK	A	A5			
VIDEOTRK	B	A5			

The following DEFINE command creates a virtual field C. All previously defined virtual fields are cleared because the ADD option was not used in the DEFINE command:

```
DEFINE FILE VIDEOTRK
  C/A10='AIRPLANE';
END
? DEFINE
```

The output of the ? DEFINE query shows that C is the only virtual field defined:

FILE	FIELD NAME	FORMAT	SEGMENT	VIEW	TYPE
VIDEOTRK	C	A10			

The following JOIN command creates a new context. Because KEEPDEFINES is set to ON, virtual field C is not cleared by the JOIN command:

```
JOIN MOVIECODE IN VIDEOTRK TAG V1 TO MOVIECODE IN MOVIES TAG M1 AS J1
? DEFINE
```

The output of the ? DEFINE query shows that field C is still defined:

FILE	FIELD NAME	FORMAT	SEGMENT	VIEW	TYPE
VIDEOTRK	C	A10			

The next DEFINE command creates a virtual field D in the new context created by the JOIN command:

```
DEFINE FILE VIDEOTRK SAVE
  D/A10='TOY STORY';
END
? DEFINE
```

The output of the ? DEFINE query shows that the virtual fields C and D are defined:

FILE	FIELD NAME	FORMAT	SEGMENT	VIEW	TYPE
VIDEOTRK	C	A10			
VIDEOTRK	D	A10			

The DEFINE FILE RETURN command clears the virtual field D created in the current context (after the JOIN):

```
DEFINE FILE VIDEOTRK RETURN
END
? DEFINE
```

The output of the ? DEFINE query shows that virtual field D was cleared, but C is still defined:

FILE	FIELD NAME	FORMAT	SEGMENT	VIEW	TYPE
VIDEOTRK	C	A10			

The following DEFINE FILE RETURN command does not clear virtual field C because field C was not created using a DEFINE FILE SAVE command:

```
DEFINE FILE VIDEOTRK RETURN
END
? DEFINE
```

The output of the ? DEFINE query shows that the virtual field C is still defined:

FILE	FIELD NAME	FORMAT	SEGMENT	VIEW	TYPE
VIDEOTRK	C	A10			



Note: DEFINE FILE RETURN is only activated when a DEFINE FILE SAVE is in effect.

Screening Segments With Conditional JOIN Expressions

The conditional JOIN command can reference any and all fields in the joined segment and any and all fields in the parent segment, or higher on the parent's path.

When active, these join expressions screen the segment on which they reside (the child or joined segment). That is, if no child segment passes the test defined by the expression, the join follows the rules of SET ALL=OFF, or SET ALL=ON when no child segment exists. Unlike WHERE phrases in TABLE commands, JOIN_WHERE screening does not automatically screen the parent segment when SET ALL=ON.

Parsing WHERE Criteria in a Join

WHERE criteria take effect in a join only when a TABLE request reference is made to a cross-referenced segment or its children. If no such reference is made, the WHERE has no effect.

The AT attribute is used to link the correct parent segment or host to the correct child or cross-referenced segment. The field values used as the AT parameter are not used to cause the link. They are used simply as segment references.



Note: If no WHERE criteria are in effect, you receive a Cartesian product.

Displaying Joined Structures

When you join two data sources together, they are subsequently treated as one logical structure. This structure results from appending the structure of the cross-referenced file to the structure of the host file. The segment in the cross-referenced file containing the shared value field becomes the child of the segment in the host file with the shared value field.

Display a Joined Structure

To display the joined structure, issue the following command:

```
CHECK FILE hostfile PICTURE
```

where:

hostfile

Is the name of the host file.

Displaying a Joined Structure

Notice that the segments belonging to the host file appear as regular segments outlined by asterisks. The segments belonging to the cross-referenced file appear as virtual segments outlined by dots. The segments of the cross-referenced file are also labeled with the cross-referenced file name below each segment.

```
JOIN PIN IN EMPDATA TO PIN IN SALHIST
CHECK FILE EMPDATA PICTURE
0 NUMBER OF ERRORS=      0
  NUMBER OF SEGMENTS=   2 ( REAL=   1  VIRTUAL=   1 )
  NUMBER OF FIELDS=    14  INDEXES=   1  FILES=    2
  NUMBER OF DEFINES=    1
  TOTAL LENGTH OF ALL FIELDS= 132
1SECTION 01.01
                STRUCTURE OF FOCUS      FILE EMPDATA  ON 03/05/01 AT
12.22.49
```

```

                EMPDATA
01          S1
*****
*PIN          **I
*LASTNAME    **
*FIRSTNAME   **
*MIDINITIAL  **
*            **
*****
*****
                I
```

```

      I
      I
      I SLHISTORY
02    I KU
.....
:PIN          :K
:EFFECTDATE  :
:OLDSALARY   :
:            :
:            :
:.....      :
JOINED  SALHIST

```

The top segment of the cross-referenced file structure is the one containing the shared-value field. If this segment is not the root segment, the cross-referenced file structure is inverted, as in an alternate file view.

The cross-referenced file segment types in the joined structure are the following:

- In unique join structures, the top cross-referenced file segment has the segment type KU. Its unique child segments have segment type KLU. Non-unique child segments have segment type KL.
- In non-unique join structures, the top cross-referenced file segment has the segment type KM. Its unique child segments have segment type KLU. Non-unique child segments have segment type KL.

The host file structure remains unchanged. The cross-referenced file may still be used independently.

List Joined Structures

To display a list of joined data sources, issue the following command:

```
? JOIN
```

This displays every JOIN command currently in effect. For example:

```

JOINS CURRENTLY ACTIVE
HOST                      CROSSREFERENCE

```

FIELD	FILE	TAG	FIELD	FILE	TAG	AS	ALL	WH
-----	----	---	-----	----	---	--	---	--
JOBCODE	EMPLOYEE		JOBCODE	JOBFILE			N	N

If the joined structure has no join name, the AS phrase is omitted. If two data sources are joined by multiple JOIN commands, only the first command you issued is displayed. The N in the WH column indicates that the join is not conditional. A Y indicates that the join is conditional.

Clearing Joined Structures

You can clear specific join structures, or all existing structures. Clearing deactivates the designated joins. If you clear a conditional join, all joins issued subsequently to that join using the same host file are also cleared.

 **Tip:** If you wish to list the current joins before clearing or see details about all active joined structures, issue the query command ? JOIN. For details and illustrations, see [Displaying Joined Structures](#).

Clear a Join

To clear a joined structure, issue this command:

```
JOIN CLEAR {joinname|*}
```

where:

joinname

Is the AS name of the joined structure you want to clear.

Clears all joined structures.

Clearing a Conditional Join

You can clear a join by issuing the JOIN CLEAR command. The effect of the JOIN CLEAR command depends on whether any conditional join exists.

- If conditional joins are found and were issued after the join you wish to clear, or if the join you wish to clear is a conditional join, then the JOIN CLEAR *as_name* command removes all joins issued after the specified join.
- If no conditional joins were issued after the join you wish to clear, only the join you specify is cleared. Any virtual fields saved in the context of a join that is cleared are also cleared. Normal joins may or may not be cleared, depending on the position of the conditional join. The JOIN CLEAR * command clears every join issued, along with its associated virtual fields. However, all virtual fields in the null context remain untouched.

i Note: The null context is the context of the data source prior to any joins being issued.

Clearing Joins

The following request creates three joins using VIDEOTRK as the host data source. The first two are conditional (JW1, JW2), and the third join is unconditional (J1):

```
JOIN FILE VIDEOTRK AT PRODCODE TO ALL
      FILE GGSales AT PCD AS JW1
WHERE PRODCODE NE PCD;
END
JOIN FILE VIDEOTRK AT TRANSDATE TO ALL
      FILE MOVIES AT REldATE AS JW2
WHERE (TRANSDATE - REldATE)/365 GT 10;
END
JOIN MOVIECODE IN VIDEOTRK TO MOVIECODE IN MOVIES AS J1
```

The next request creates a conditional join (JW3) using MOVIES as the host data source:

```
JOIN FILE MOVIES AT MOVIECODE TO ONE
      FILE VIDEOTRK AT TRANSDATE AS JW3
```

```
WHERE (TRANSDATE - RELDATE)/365 LT 2;
END
```

The last request creates a third conditional join (JW4) that uses VIDEOTRK as the host data source:

```
JOIN FILE VIDEOTRK AT LASTNAME TO ALL
      FILE EMPLOYEE AT LAST_NAME AS JW4
WHERE LASTNAME GE LAST_NAME;
END
```

Following is the output of the ? JOIN query after executing these joins:

```
? JOIN
JOINS CURRENTLY ACTIVE
```

HOST			CROSSREFERENCE					
FIELD	FILE	TAG	FIELD	FILE	TAG	AS	ALL	WH
-----	----	---	-----	----	---	--	---	--
PRODCODE	VIDEOTRK		PCD	GGSales		JW1	Y	Y
TRANSDATE	VIDEOTRK		RELDATE	MOVIES		JW2	Y	Y
MOVIECODE	VIDEOTRK		MOVIECODE	MOVIES		J1	N	N
MOVIECODE	MOVIES		TRANSDATE	VIDEOTRK		JW3	N	Y
LASTNAME	VIDEOTRK		LAST_NAME	EMPLOYEE		JW4	Y	Y

Clearing JW2 clears all joins that were issued after JW2 and that use the same host data source. JW1 remains because it was issued prior to JW2, and JW3 remains because it uses a different host data source:

```
JOIN CLEAR JW2
? JOIN
JOINS CURRENTLY ACTIVE
```

HOST			CROSSREFERENCE					
FIELD	FILE	TAG	FIELD	FILE	TAG	AS	ALL	WH
-----	----	---	-----	----	---	--	---	--
PRODCODE	VIDEOTRK		PCD	GGSales		JW1	Y	Y
MOVIECODE	MOVIES		TRANSDATE	VIDEOTRK		JW3	N	Y

Merging Data Sources

You can gather data for your reports by merging the contents of data structures with the MATCH command, or concatenating data sources with the MORE phrase, and reporting from the combined data.

Merging Data

You can merge two or more data sources, and specify which records to merge and which to sort out, using the MATCH command. The command creates a new data source (a HOLD file), into which it merges fields from the selected records. You can report from the new data source and use it as you would use any other HOLD file.

You select the records to be merged into the new data source by specifying sort fields in the MATCH command. You specify one set of sort fields (using the BY phrase), for the first data source, and a second set of sort fields for the second data source. The MATCH command compares all sort fields that have been specified in common for both data sources, and then merges all records from the first data source whose sort values match those in the second data source into the new HOLD file. You can specify up to 128 sort sets. This includes the number of common sort fields.

In addition to merging data source records that share values, you can merge records based on other relationships. For example, you can merge all records in each data source whose sort values are not matched in the other data source. Yet another type of merge combines all records from the first data source with any matching records from the second data source.

You can merge up to 16 sets of data in one Match request. For example, you can merge different data sources, or data from the same data source.



Note: The limit of 16 applies to the most complex request. Simpler requests may be able to merge more data sources.

Merge Data Sources

The syntax of the MATCH command is similar to that of the TABLE command:

```
MATCH FILE file1
.
.
.
RUN
FILE file2
.
.
.
[AFTER MATCH merge_phrase]
RUN
FILE file3
.
.
.
[AFTER MATCH merge_phrase]
END
```

where:

file1

Is the first data source from which MATCH retrieves requested records.

merge_phrase

Specifies how the retrieved records from the files are to be compared. For details, see [Merge Phrases](#).

file2/file3

Are additional data sources from which MATCH retrieves requested records.

Note that a RUN command must follow each AFTER MATCH command (except for the last one). The END command must follow the final AFTER MATCH command.

MATCH generates a HOLD file. You can print the contents of the HOLD file using the PRINT command with the wildcard character (*).

Types of MATCH Processing

There are two types of MATCH processing, grouped and ungrouped. Grouped processing is the newer type of MATCH processing, and is the processing used by default. Ungrouped processing is the legacy MATCH processing. If you need to invoke legacy processing, you can use the `SET MATCHCOLUMNORDER = UNGROUPED` command.

In all MATCH requests:

- The two sides of the merge, the OLD and the NEW, are matched together based on their common high-order BY fields. In order for actual matching to take place between the OLD and NEW files, the high-order BY fields have to be the same. If there are no common high-order BY fields, the records are concatenated on a record-by-record basis.
- The output selected from the OLD and NEW sides is based on the AFTER MATCH command.

The output stage of the MATCH differs for grouped and ungrouped processing.

- With grouped processing, the output file has each common sort key (BY field) followed its display fields in the order specified in the request. As a result, ungrouped processing is limited to flat file output.
- In contrast, with grouped processing, fields in the request are grouped with their highest common sort fields in the output file. This enables you to generate multi-segment hierarchical output files in FOCUS or XFOCUS format by using multiple display commands on each side of the merge. In fact, you can create the output file using any format that has a corresponding Master File.

For standard MATCH requests that use the same sort keys on both sides of the MATCH (OLD and NEW), grouped and ungrouped processing produce the same output.

However, in requests that use multiple display commands or differing sort fields on each side of the merge, the grouping of fields with their sort keys can produce output files in which the field order is different from the legacy processing. In any case where the new behavior generates output that is different from previous results and not desirable, the `SET MATCHCOLUMNORDER` command is available to return the legacy results.

For example, if you use MATCH to create output that includes a list of products with columns of aggregations based on differing sorts, `MATCHCOLUMNORDER=UNGROUPED` will ensure that the sequence of the column output will remain what it was in the past.

The way MATCH merges data depends on the order in which you name data sources in the request, the BY fields, display commands, the type of processing, and the merge phrases you use. In general, however, processing is as follows:

1. MATCH retrieves requested records from the first data source you name, and writes them to a temporary work area.
2. MATCH retrieves requested records from the second data source you name, and writes them to a temporary work area.
3. It compares the common high-order sort fields from the retrieved records as specified in the merge phrase (for example, OLD-OR-NEW). For more information, see [Merge Phrases](#).
4. If the default-grouped processing is in effect, it may re-order the fields to group them under their common sort fields.
5. It writes the merged results of the comparison to a temporary data source (if there are more MATCH operations). It cycles through all data sources named until END is encountered.
6. It writes final records to the HOLD file.

Controlling MATCH Processing

```
SET MATCHCOLUMNORDER = {GROUPED|UNGROUPED}
```

where:

GROUPED

Groups fields in the output file under their common high-order sort fields. This is the default value.

UNGROUPED

Does not group fields in the output file with their common high-order sort fields, but lays them out as specified in the MATCH request.

Usage Notes for Match Requests

- With ungrouped processing, you cannot specify a format for the HOLD file generated by MATCH. It will be created as a single-segment BINARY or ALPHA HOLD file, depending on the value of the HOLDFORMAT parameter. The merge process does not change the original data sources.
- Alias names are assigned sequentially (E01, E02, ...) in the HOLD Master File that results from the MATCH request. When the same field name is used multiple times in the MATCH, users distinguish between them in requests against the HOLD file by referencing these alias names instead of the field names.

With grouped processing, fields are rearranged in the Master File, and this causes the alias names to represent different fields from the same alias names assigned with ungrouped processing. This can produce different results if you switch from one type of processing to the other.

To avoid using alias names, use the AS phrase in your MATCH request to create distinct field names (except for the common high-order BY fields, which have to be the same), and use those field names in requests against the HOLD file.

- The ACROSS, BY HIGHEST/LOWEST n , IN-GROUPS-OF, WHERE TOTAL, and IF TOTAL phrases, and the COMPUTE command, are not permitted in a MATCH request. You can, however, use the DEFINE command.
- Up to 128 BY phrases and the maximum number of display fields can be used in each MATCH request. The count of sort sets includes the number of common sort fields. The maximum number of display fields is determined by a combination of factors. For details, see [Displaying Report Data](#).
- You must specify at least one BY field for each file used in the MATCH request.
- When used with MATCH, the SET HOLDLIST parameter behaves as if HOLDLIST were set to ALL.
- The following prefix operators are not supported in MATCH requests: DST., DST.CNT., RNK., ST., and CT.

Merging Data Sources

In the following request, the high-order sort field is the same for both files, so the result is the same using grouped and ungrouped processing.

```

MATCH FILE EDUCFILE
SUM COURSE_CODE
BY EMP_ID
RUN
FILE EMPLOYEE
SUM LAST_NAME AND FIRST_NAME
BY EMP_ID BY CURR_SAL
AFTER MATCH HOLD OLD-OR-NEW
END
-*****
-* PRINT CONTENTS OF HOLD FILE
-*****
TABLE FILE HOLD
PRINT *
END

```

The merge phrase used in this example was OLD-OR-NEW. This means that records from both the first (old) data source plus the records from the second (new) data source appear in the HOLD file.

Note that if you are working in an interactive environment, you will receive FOCUS response messages following the END statement as part of execution. A message indicates how many records were retrieved from each file.

The output is:

EMP_ID	COURSE_CODE	CURR_SAL	LAST_NAME	FIRST_NAME
071382660	101	\$11,000.00	STEVENS	ALFRED
112847612	103	\$13,200.00	SMITH	MARY
117593129	203	\$18,480.00	JONES	DIANE
119265415	108	\$9,500.00	SMITH	RICHARD
119329144		\$29,700.00	BANNING	JOHN
123764317		\$26,862.00	IRVING	JOAN
126724188		\$21,120.00	ROMANS	ANTHONY
212289111	103	\$.00		
219984371		\$18,480.00	MCCOY	JOHN
315548712	108	\$.00		
326179357	301	\$21,780.00	BLACKWOOD	ROSEMARIE
451123478	101	\$16,100.00	MCKNIGHT	ROGER
543729165		\$9,000.00	GREENSPAN	MARY
818692173	302	\$27,062.00	CROSS	BARBARA

Comparing Grouped and Ungrouped Processing

The following MATCH request has two SUM commands and one PRINT command for each file, with all sort fields common to both files. The SET MATCHCOLUMNORDER = UNGROUPED command is issued to invoke legacy processing.

```

SET MATCHCOLUMNORDER = UNGROUPED
MATCH FILE GGSales
SUM DOLLARS
BY ST
SUM BUDDOLLARS BY ST BY CITY
PRINT UNITS BY ST BY CITY BY CATEGORY
RUN
FILE GGSales
SUM DOLLARS
BY ST
SUM BUDDOLLARS BY ST BY CITY
PRINT BUDUNITS BY ST BY CITY BY CATEGORY
AFTER MATCH HOLD OLD-OR-NEW
END
TABLE FILE HOLD
PRINT *
ON TABLE SET PAGE NOLEAD
ON TABLE SET STYLE *
TYPE=REPORT, GRID=OFF, SIZE=9,$
ENDSTYLE
END

```

The HOLD Master File follows. Since the sort fields are common to both files, the two files were merged based on those fields. However, note that the order of fields in the Master File follows the order in the request, the highest-level sort field followed by its display field, then the next sort field followed by its display fields, and so on.

```

FILENAME=HOLD, SUFFIX=FIX      , IOTYPE=BINARY, $
SEGMENT=HOLD, SEGTYPE=S1, $
  FIELDNAME=ST, ALIAS=E01, USAGE=A02, ACTUAL=A04, $
  FIELDNAME=DOLLARS, ALIAS=E02, USAGE=I08, ACTUAL=I04, $
  FIELDNAME=CITY, ALIAS=E03, USAGE=A20, ACTUAL=A20, $
  FIELDNAME=BUDDOLLARS, ALIAS=E04, USAGE=I08, ACTUAL=I04, $
  FIELDNAME=CATEGORY, ALIAS=E05, USAGE=A11, ACTUAL=A12, $
  FIELDNAME=UNITS, ALIAS=E06, USAGE=I08, ACTUAL=I04, $
  FIELDNAME=DOLLARS, ALIAS=E07, USAGE=I08, ACTUAL=I04, $

```

```
FIELDNAME=BUDDOLLARS, ALIAS=E08, USAGE=I08, ACTUAL=I04, $
FIELDNAME=BUDUNITS, ALIAS=E09, USAGE=I08, ACTUAL=I04, $
```

The partial output is shown in the following image.

ST	DOLLARS	CITY	BUDDOLLARS	CATEGORY	UNITS	DOLLARS	BUDDOLLARS	BUDUNITS
CA	7642261	Los Angeles	3669484	Coffee	1667	7642261	3669484	1464
CA	7642261	Los Angeles	3669484	Coffee	1663	7642261	3669484	1464
CA	7642261	Los Angeles	3669484	Coffee	1519	7642261	3669484	1464
CA	7642261	Los Angeles	3669484	Coffee	1452	7642261	3669484	1520
CA	7642261	Los Angeles	3669484	Coffee	1663	7642261	3669484	1463
CA	7642261	Los Angeles	3669484	Coffee	1508	7642261	3669484	1539
CA	7642261	Los Angeles	3669484	Coffee	1615	7642261	3669484	1759
CA	7642261	Los Angeles	3669484	Coffee	1449	7642261	3669484	1494
CA	7642261	Los Angeles	3669484	Coffee	1208	7642261	3669484	1038
CA	7642261	Los Angeles	3669484	Coffee	1272	7642261	3669484	1512

Changing the UNGROUPED setting to GROUPED produces the following Master File. The fields that have the same common sort fields from both files are moved to be under those sort fields in the Master File.

```
FILENAME=HOLD, SUFFIX=FIX      , IOTYPE=BINARY, $
SEGMENT=HOLD, SEGTYPE=S1, $
  FIELDNAME=ST, ALIAS=E01, USAGE=A02, ACTUAL=A04, $
  FIELDNAME=DOLLARS, ALIAS=E02, USAGE=I08, ACTUAL=I04, $
  FIELDNAME=DOLLARS, ALIAS=E03, USAGE=I08, ACTUAL=I04, $
  FIELDNAME=CITY, ALIAS=E04, USAGE=A20, ACTUAL=A20, $
  FIELDNAME=BUDDOLLARS, ALIAS=E05, USAGE=I08, ACTUAL=I04, $
  FIELDNAME=BUDDOLLARS, ALIAS=E06, USAGE=I08, ACTUAL=I04, $
  FIELDNAME=CATEGORY, ALIAS=E07, USAGE=A11, ACTUAL=A12, $
  FIELDNAME=UNITS, ALIAS=E08, USAGE=I08, ACTUAL=I04, $
  FIELDNAME=BUDUNITS, ALIAS=E09, USAGE=I08, ACTUAL=I04, $
```

The partial output is shown in the following image.

ST	DOLLARS	DOLLARS	CITY	BUDDOLLARS	BUDDOLLARS	CATEGORY	UNITS	BUDUNITS
CA	7642261	7642261	Los Angeles	3669484	3669484	Coffee	1667	1464
CA	7642261	7642261	Los Angeles	3669484	3669484	Coffee	1663	1464
CA	7642261	7642261	Los Angeles	3669484	3669484	Coffee	1519	1464
CA	7642261	7642261	Los Angeles	3669484	3669484	Coffee	1452	1520
CA	7642261	7642261	Los Angeles	3669484	3669484	Coffee	1663	1463
CA	7642261	7642261	Los Angeles	3669484	3669484	Coffee	1508	1539
CA	7642261	7642261	Los Angeles	3669484	3669484	Coffee	1615	1759
CA	7642261	7642261	Los Angeles	3669484	3669484	Coffee	1449	1494
CA	7642261	7642261	Los Angeles	3669484	3669484	Coffee	1208	1038
CA	7642261	7642261	Los Angeles	3669484	3669484	Coffee	1272	1512

For the request that uses the GROUPED value for MATCHCOLUMNORDER, you can change the HOLD command to produce a FORMAT FOCUS output file, as follows.

```
AFTER MATCH HOLD FORMAT FOCUS OLD-OR-NEW
```

The following hierarchical multi-segment Master File is generated.

```
FILENAME=HOLD      , SUFFIX=FOC      , $
  SEGMENT=SEG01, SEGTYPE=S1, $
    FIELDNAME=ST, ALIAS=E01, USAGE=A02,
      TITLE='State', DESCRIPTION='State', $
    FIELDNAME=DOLLARS, ALIAS=E02, USAGE=I08,
      TITLE='Dollar Sales', DESCRIPTION='Total dollar amount of reported
sales', $
    FIELDNAME=DOLLARS, ALIAS=E03, USAGE=I08,
      TITLE='Dollar Sales', DESCRIPTION='Total dollar amount of reported
sales', $
  SEGMENT=SEG02, SEGTYPE=S1, PARENT=SEG01, $
    FIELDNAME=CITY, ALIAS=E04, USAGE=A20,
      TITLE='City', DESCRIPTION='City', $
    FIELDNAME=BUDDOLLARS, ALIAS=E05, USAGE=I08,
      TITLE='Budget Dollars', DESCRIPTION='Total sales quota in
dollars', $
    FIELDNAME=BUDDOLLARS, ALIAS=E06, USAGE=I08,
      TITLE='Budget Dollars', DESCRIPTION='Total sales quota in
dollars', $
  SEGMENT=SEG03, SEGTYPE=S2, PARENT=SEG02, $
    FIELDNAME=CATEGORY, ALIAS=E07, USAGE=A11,
      TITLE='Category', DESCRIPTION='Product category', $
    FIELDNAME=FOCLIST, ALIAS=E08, USAGE=I5, $
    FIELDNAME=UNITS, ALIAS=E09, USAGE=I08,
      TITLE='Unit Sales', DESCRIPTION='Number of units sold', $
  SEGMENT=SEG04, SEGTYPE=S1, PARENT=SEG03, $
    FIELDNAME=FOCLIST, ALIAS=E10, USAGE=I5, $
    FIELDNAME=BUDUNITS, ALIAS=E11, USAGE=I08,
      TITLE='Budget Units', DESCRIPTION='Number of units budgeted', $
```

Merge Phrases

MATCH logic depends on the concept of old and new data sources. Old refers to the first data source named in the request, and new refers to the second data source. The result of each merge creates a HOLD file until the END command is encountered.

The following diagram illustrates the general merge process:

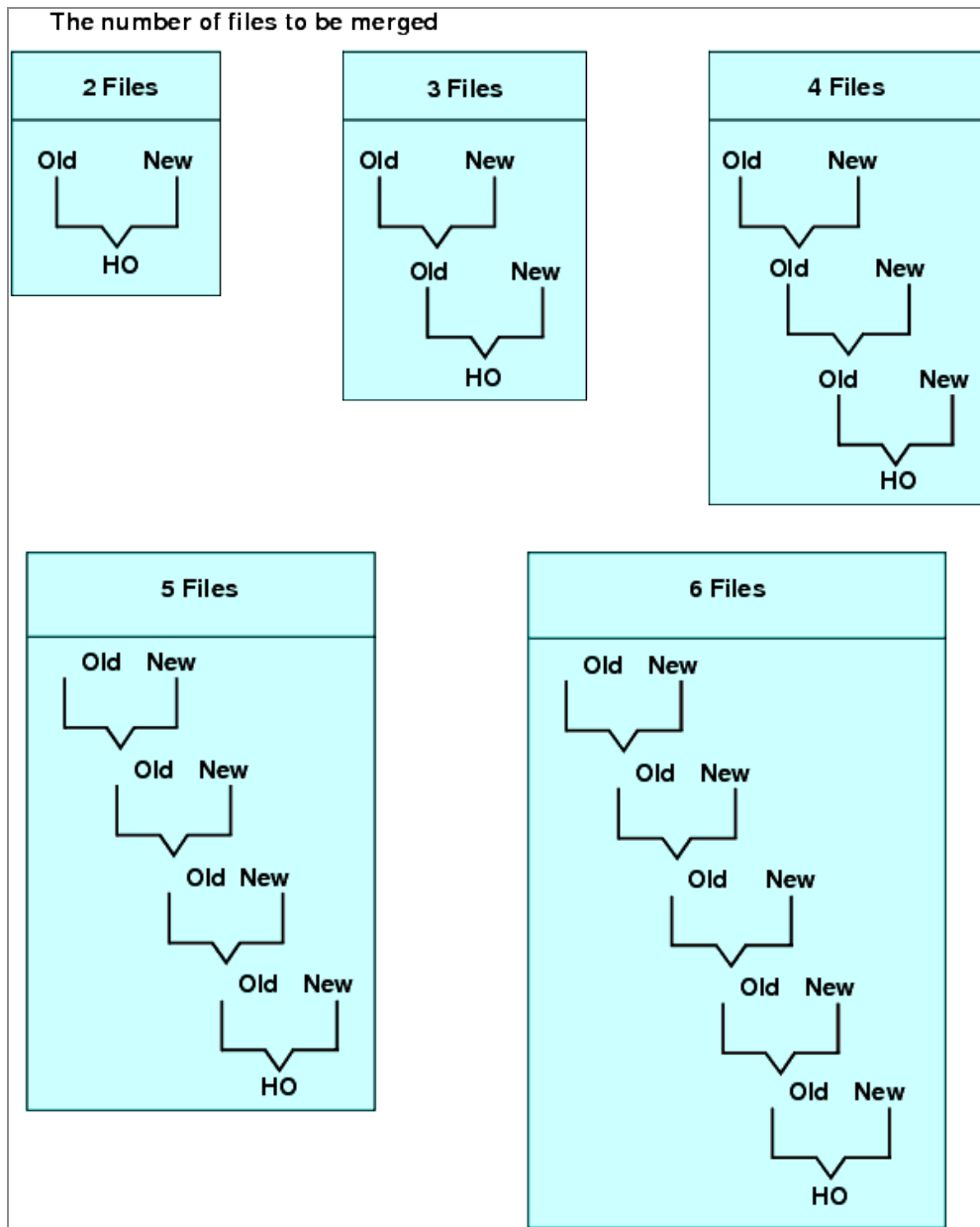

Specify Merge Phrases

```
AFTER MATCH HOLD [AS 'name'] mergetype
```

where:

AS 'name'

Specifies the name of the extract data source created by the MATCH command. The default is HOLD.

mergetype

Specifies how the retrieved records from the files are to be compared.

The results of each phrase are graphically represented using Venn diagrams. In the diagrams, the left circle represents the old data source, the right circle represents the new data source, and the shaded areas represent the data that is written to the HOLD file.

OLD-OR-NEW specifies that all records from both the old data source and the new data source appear in the HOLD file. This is the default if the AFTER MATCH line is omitted.

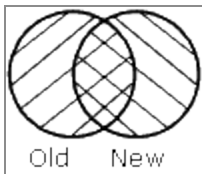

OLD-AND-NEW specifies that records that appear in both the old and new data sources appear in the HOLD file. (The intersection of the sets.)

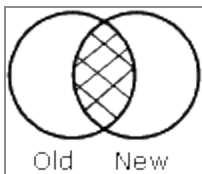

OLD-NOT-NEW specifies that records that appear only in the old data source appear in the HOLD file.

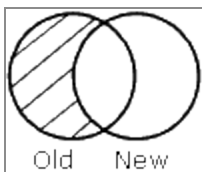

NEW-NOT-OLD specifies that records that appear only in the new data source appear in the HOLD file.

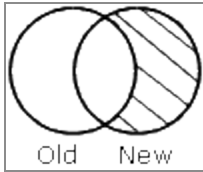

OLD-NOR-NEW specifies that only records that are in the old data source but not in the new data source, or in the new data source but not in the old, appear in the HOLD file (the complete set of non-matching records from both data sources).

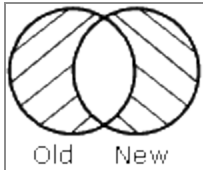

OLD specifies that all records from the old data source, and any matching records from the new data source, are merged into the HOLD file.

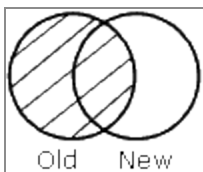

NEW specifies that all records from the new data source, and any matching records from the old data source, are merged into the HOLD file.

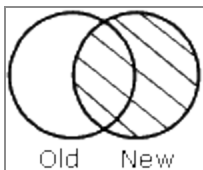

MATCH Processing With Common High-Order Sort Fields

When you construct your MATCH so that the first sort (BY) field (called the common high-order sort field) used for both data sources is the same, the match compares the values of the common high-order sort fields. If the entire sequence of sort fields is common to both files, all are compared.

At least one pair of sort fields is required. Field formats must be the same. In some cases, you can redefine a field format using the DEFINE command. If the field names differ, use the AS phrase to rename the second sort field to match the first. When the AS phrase is used in a MATCH request, the specified field is automatically renamed in the resulting HOLD file.

When you are merging files with common sort fields, the following assumptions are made:

- If one of the sort fields is a subset of the other, a one-to-many relationship is assumed.
- If neither of the sort fields is a subset of the other, a one-to-one relationship is assumed. At most, one matching record is retrieved.

MATCH Processing With Common High-Order Sort Fields

To understand common high-order sort fields more clearly, consider some of the data from the following data sources

EMPLOYEE Data Source		EDUCFILE Data Source	
EMP_ID	LAST_NAME	EMP_ID	COURSE_CODE
071382660	STEVENS	071382660	101
119329144	BANNING	212289111	103
112847612	SMITH	112847612	103

and this MATCH request:

```
MATCH FILE EMPLOYEE
SUM LAST_NAME BY EMP_ID
RUN
FILE EDUCFILE
SUM COURSE_CODE BY EMP_ID
AFTER MATCH HOLD OLD-OR-NEW
END
```

MATCH processing occurs as follows:

- Since there is a common high-order sort field (EMP_ID), the MATCH logic begins by matching the EMP_ID values in records from the EMPLOYEE and EDUCFILE files.
- There are records from both files with an EMP_ID value of 071382660. Since there is a match, this record is written to the HOLD file:

```
Record n: 071382660 STEVENS 101
```

- There are records from both files with an EMP_ID value of 112847612. Since there is a match, this record is written to the HOLD file:

```
Record n: 112847612 SMITH 103
```

- The records do not match where a record from the EMPLOYEE file has an EMP_ID value of 119329144 and a record from the EDUCFILE file has an EMP_ID value of 212289111. The record with the lower value is written to the HOLD file and a space is inserted for the missing value:

```
Record n: 119329144 BANNING
```

- Similarly, the 212289111 record exists only in the EDUCFILE file, and is written as:

```
Record n: 212289111 103
```

The following code produces a report of the records in the HOLD file:

```
TABLE FILE HOLD
PRINT *
END
```

The output is:

EMP_ID	LAST_NAME	COURSE_CODE
-----	-----	-----
071382660	STEVENS	101
112847612	SMITH	103
117593129	JONES	203
119265415	SMITH	108
119329144	BANNING	

123764317	IRVING	
126724188	ROMANS	
212289111		103
219984371	MCCOY	
315548712		108
326179357	BLACKWOOD	301
451123478	MCKNIGHT	101
543729165	GREENSPAN	
818692173	CROSS	302

Merging With a Common High-Order Sort Field

This request combines data from the JOBFILE and PROD data sources. The sort fields are JOBCODE and PROD_CODE, renamed as JOBCODE:

```
MATCH FILE JOBFILE
PRINT JOB_DESC
BY JOBCODE
RUN
FILE PROD
PRINT PROD_NAME
BY PROD_CODE AS 'JOBCODE'
AFTER MATCH HOLD OLD-OR-NEW
END
```

Merging Without a Common High-Order Sort Field

If there are no common high-order sort fields, a match is performed on a record-by-record basis. The following request matches the data and produces the HOLD file:

```
MATCH FILE EMPLOYEE
PRINT LAST_NAME AND FIRST_NAME
BY EMP_ID
RUN
FILE EMPLOYEE
PRINT EMP_ID
BY LAST_NAME BY FIRST_NAME
AFTER MATCH HOLD OLD-OR-NEW
END
```

```
TABLE FILE HOLD
PRINT *
END
```

The retrieved records from the two data sources are written to the HOLD file; no values are compared. The output is:

EMP_ID	LAST_NAME	FIRST_NAME	LAST_NAME	FIRST_NAME	EMP_ID
071382660	STEVENS	ALFRED	BANNING	JOHN	
119329144					
112847612	SMITH	MARY	BLACKWOOD	ROSEMARIE	
326179357					
117593129	JONES	DIANE	CROSS	BARBARA	
818692173					
119265415	SMITH	RICHARD	GREENSPAN	MARY	
543729165					
119329144	BANNING	JOHN	IRVING	JOAN	
123764317					
123764317	IRVING	JOAN	JONES	DIANE	
117593129					
126724188	ROMANS	ANTHONY	MCCOY	JOHN	
219984371					
219984371	MCCOY	JOHN	MCKNIGHT	ROGER	
451123478					
326179357	BLACKWOOD	ROSEMARIE	ROMANS	ANTHONY	
126724188					
451123478	MCKNIGHT	ROGER	SMITH	MARY	
112847612					
543729165	GREENSPAN	MARY	SMITH	RICHARD	
119265415					
818692173	CROSS	BARBARA	STEVENS	ALFRED	
071382660					

Fine-Tuning MATCH Processing

You can fine-tune the MATCH process using the PRINT and SUM commands. To understand their difference, you should have an understanding of the one-to-many relationship: SUM generates one record from many, while PRINT displays each individual record. Through proper choices of BY fields, it is possible to use only the SUM command and get the same result that PRINT would produce.

Using Display Commands in MATCH Processing

To illustrate the effects of PRINT and SUM on the MATCH process, consider data sources A and B and the series of requests that follow:

A			B		
F1	F2	F3	F1	F4	F5
1	x	100	1	a	10
2	y	200	1	b	20
			2	c	30
			2	d	40

Request 1: This request sums the fields F2 and F3 from file A, sums the fields F4 and F5 from file B, and uses F1 as the common high-order sort field.

```
MATCH FILE A
SUM F2 AND F3 BY F1
RUN
FILE B
SUM F4 AND F5 BY F1
AFTER MATCH HOLD OLD-OR-NEW
END
```

The HOLD file contains the following data:

F1	F2	F3	F4	F5
1	x	100	b	30
2	y	200	d	70

Note that the resulting file contains only 1 record for each common high-order sort field.

Request 2: This request sums fields F2 and F3 from file A, prints fields F4 and F5 from file B, and uses F1 as the common high-order sort field.

```
MATCH FILE A
SUM F2 AND F3 BY F1
RUN
FILE B PRINT F4 AND F5 BY F1
```

```
AFTER MATCH HOLD OLD-OR-NEW
END
```

The HOLD file contains:

F1	F2	F3	F4	F5
1	x	100	a	10
1	x	100	b	20
2	y	200	c	30
2	y	200	d	40

Note that the records from file A are duplicated for each record from file B.

Request 3: This request prints fields F2 and F3 from file A, sums fields F4 and F5 from file B, and uses F1 as the common high-order sort field.

```
MATCH FILE A
PRINT F2 AND F3 BY F1
RUN
FILE B
SUM F4 AND F5 BY F1
AFTER MATCH HOLD OLD-OR-NEW
END
```

The HOLD file contains:

F1	F2	F3	F4	F5
1	x	100	b	30
2	y	200	d	70

Note that each record from file A is included, but only the last record from file B for each common high-order sort field is included.

Request 4: This request prints fields F2 and F3 from file A, prints fields F4 and F5 from file B, and uses F1 as the common high-order sort field.

```
MATCH FILE A
PRINT F2 AND F3 BY F1
RUN
FILE B PRINT F4 AND F5 BY F1
```

```
AFTER MATCH HOLD OLD-OR-NEW
END
```

The HOLD file contains:

F1	F2	F3	F4	F5
1	x	100	a	10
1		0	b	20
2	y	200	c	30
2		0	d	40

Note the blank value for F2 and the 0 for F3.

Request 5: This request sums the fields F2 and F3 from file A, sums the field F5 from file B and sorts it by field F1, the common high-order sort field, and by F4.

```
MATCH FILE A
SUM F2 AND F3 BY F1
RUN
FILE B
SUM F5 BY F1 BY F4
AFTER MATCH HOLD OLD-OR-NEW
END
```

The HOLD file contains:

F1	F2	F3	F4	F5
1	x	100	a	10
1	x	100	b	20
2	y	200	c	30
2	y	200	d	40

Note that the records for file A are printed for every occurrence of the record in file B.

Universal Concatenation

With universal concatenation, you can retrieve data from unlike data sources in a single request; all data, regardless of source, appears to come from a single file. The MORE phrase can concatenate all types of data sources (such as, FOCUS, DB2, IMS, and VSAM), provided

they share corresponding fields with the same format. You can use WHERE and IF selection tests in conjunction with MORE. For related information, see [Selecting Records for Your Report](#).

To use MORE, you must divide your request into:

- One main request that retrieves the first data source and defines the data fields, sorting criteria, and output format for all data.
- Subrequests that define the data sources and fields to be concatenated to the data of the main request. The fields printed and sorted by the main request must exist in each concatenated data source. If they do not, you must create them as virtual fields.

During retrieval, data is gathered from each data source in turn, then all data is sorted and the output formatted as specified in the main request.

Concatenate Data Sources

The MORE phrase, which is accessible within the TABLE and MATCH commands, specifies how to concatenate data from sources with dissimilar Master Files.

```
{TABLE|MATCH} FILE file1main request
MORE
FILE file2
  subrequest
MORE
FILE file3
  subrequest
MORE
.
.
.
{END|RUN}
```

where:

TABLE|MATCH

Begins the request that concatenates the data sources.

file1

Is the name of the first data source.

main request

Is a request, without END or RUN, that retrieves the first data source and defines the data fields, sorting criteria, and output format for all data. WHERE and IF criteria in the main request apply only to *file1*.

When concatenating files within the TABLE command, you can also define calculated values for the first data source.

MORE

Begins a subrequest. There is no limit to the number of subrequests, other than available memory.

FILE file2

Defines *file2* as the second data source for concatenation.

subrequest

Is a subrequest. Subrequests can only include WHERE and IF phrases.

END|RUN

Ends the request.

Concatenating Data Sources

Both the EMPLOYEE and the EXPERSON data sources contain employee information. You can concatenate their common data into a single file:

- EMPLOYEE contains the field values EMP_ID=123456789 and CURR_SAL=50.00.
- EXPERSON contains the field values SSN=987654321 and WAGE=100.00.

The following annotated request concatenates the two data sources:

```
DEFINE FILE EXPERSON
1. EMP_ID/A9 = SSN;
   CURR_SAL/D12.2 = WAGE;
   END
2. TABLE FILE EMPLOYEE
   PRINT CURR_SAL
   BY EMP_ID
3. MORE
```



```
FILE EMPERSON
END
```

1. The request must re-map the field names and formats in the EMPERSON data source to match those used in the main request.
2. The main request names the first data source in the concatenation, EMPLOYEE. It also defines the print and sort fields for both data sources.
3. The MORE phrase starts the subrequest that concatenates the next data source, EMPERSON. No display commands are allowed in the subrequest. IF and WHERE criteria are the only report components permitted in a subrequest.

Field Name and Format Matching

All fields referenced in the main request must either exist with the same names and formats in all the concatenated files, or be remapped to those names and formats using virtual fields. Referenced fields include those used in COMPUTE commands, headings, aggregation phrases, sort phrases, and the PRINT, LIST, SUM, COUNT, WRITE, or ADD commands.

A successful format match means that:

Usage Format Type	Correspondence
A	Format type and length must be equal.
I, F, D	Format type must be the same.
P	Format type and scale must be equal.
DATE (new)	Format information (type, length, components, and order) must always correspond.
DATE (old)	Edit options must be the same.
DATE -TIME	Format information (type, length, components, and order) must always correspond.

Text (TX) fields and CLOB fields (if supported) cannot be concatenated.

Matching Field Names and Formats

The following annotated example concatenates data from the EMPDATA and PAYHIST data sources. [Master Files and Diagrams](#), contains the Master Files referenced in the request.

 **Tip:** PAYHIST is a fixed-format file. You need to issue a FILEDEF or ALLOCATE command in order to use it. See the *Overview and Operations* manual for more information.

```

DEFINE FILE EMPDATA
1. NEWID/A11 = EDIT (ID, '999-99-9999');
   END
   DEFINE FILE PAYHIST
1. NEWID/A11 = EDIT (SSN, '999-99-9999');
   CSAL/D12.2M = NEW_SAL;
   END
2. TABLE FILE EMPDATA
   HEADING
   "EMPLOYEE SALARIES"
   " "
3. PRINT CSAL
3. BY NEWID AS 'EMPLOYEE ID'
4. WHERE CSAL GT 65000
5. MORE
   FILE PAYHIST
6. WHERE NEW_SAL GT 500
   END

```

In the resulting report, the EMPLOYEE ID values that start with 000 are from EMPDATA, and the values that start with 100 are from PAYHIST:

```

EMPLOYEE SALARIES
EMPLOYEE ID          SALARY
-----
000-00-0030          $70,000.00
000-00-0070          $83,000.00
000-00-0200          $115,000.00
000-00-0230          $80,500.00
000-00-0300          $79,000.00
100-10-1689          $842.90

```

	\$982.90
100-11-9950	\$508.75
100-14-2166	\$876.45
100-15-5843	\$508.75
100-16-2791	\$567.89
100-16-4984	\$1,236.78
100-17-5025	\$734.56
100-18-9299	\$567.89

Merging Concatenated Data Sources

You can use the MORE phrase in a MATCH request to merge up to 16 sets of concatenated data sources.

You must meet all MATCH requirements in the main request. All data sources to be merged must be sorted by at least one field with a common format.

The MATCH request results in a HOLD file containing the merged data. You can specify how you want each successive file merged using an AFTER MATCH command. For example, you can retain:

- All records from both files (OLD-OR-NEW). This is the default.
- Only records common to both files (OLD-AND-NEW).
- Records from the first file with no match in the second file (OLD-NOT-NEW).
- Records from the second file with no match in the first file (NEW-NOT-OLD).
- All non-matching records from both files; that is, records that were in either one of the files but not in both (OLD-NOR-NEW).
- All records from the first file with all matching records from the second file (OLD).
- All records from the second file with all matching records from the first file (NEW).

Merge Concatenated Data Sources

1. MATCH FILE file1main request
MORE

```
2. FILE file2subrequest
   MORE
3. FILE file3subrequest
   RUN
4. FILE file4main request
5. [AFTER MATCH merge_phrase]
   MORE
6. FILE file5subrequest
   MORE
7. FILE file6subrequest
   RUN
8. FILE file7main request
9. [AFTER MATCH merge_phrase]
   MORE
10. FILE file8subrequest
    MORE
11. FILE file9subrequest
    END
```

1. Starts the first answer set in the MATCH. File1 is the first data source in the first answer set.
2. Concatenates file2 to file1 in the first MATCH answer set.
3. Concatenates file3 to file1 and file2 in the first MATCH answer set.
4. Starts the second answer set in the MATCH. File4 is the first data source in the second answer set.
5. All data concatenated in the first answer set is merged with the data concatenated in the second answer set using the AFTER MATCH merge_phrase in the second answer set.
6. Concatenates file5 to file4 in the second MATCH answer set.
7. Concatenates file6 to file4 and file5 in the second MATCH answer set.
8. Starts the third answer set in the MATCH. File7 is the first data source in the third answer set.
9. All merged data from the first and second answer sets, now a HOLD file, is merged with the data concatenated in the third answer set using the AFTER MATCH merge_phrase in the third answer set. This final set of merged data is stored in a HOLD file.
10. Concatenates file8 to file7 in the third MATCH answer set.

11. Concatenates file9 to file7 and file8 in the third MATCH answer set.

Using Sort Fields in MATCH Requests

If the data sources in the MATCH share common high-order sort fields with identical names and formats, the MATCH process merges records with matching sort field values from each of the files. If the two data sources in the MATCH have the same sort field with different names, you can change one of the names with an AS phrase.

If the files in the MATCH do not share a high-order sort field, the fields are not compared. Instead, the fields from the first record in each data source are merged to create the first record in the HOLD file, and so on for all remaining records.

Merging Concatenated Data Sources With Common High-Order Sort Fields

The following annotated sample-stored procedure illustrates MATCH with MORE, using a common sort field:

```
1. DEFINE FILE EMPDATA
   CURR_SAL/D12.2M = CSAL;
   FIRST_NAME/A10 = FN;
   EID/A9 = PIN;
   END

   -*Start MATCH.

2. MATCH FILE EMPLOYEE
   SUM CURR_SAL AS 'CURRENT'
   FIRST_NAME AS 'FIRST'
   BY EID AS 'SSN'
   -*Concatenate file EMPDATA to EMPLOYEE to form first MATCH answer
   set.

3. MORE
   FILE EMPDATA
   RUN
   -*Second MATCH answer set:

4. FILE TRAINING
   PRINT EXPENSES
```

```

5.    BY PIN AS 'SSN'
6.    AFTER MATCH HOLD OLD-OR-NEW
      END

      -*Print merged file:

7. TABLE FILE HOLD
      PRINT *
      END

```

1. Defines the EMPDATA fields needed for concatenating it to EMPLOYEE.
2. Starts the MATCH and the main request in the concatenation. The main request defines all printing and sorting for the concatenated files. The sort field is called SSN in the resulting file.
3. Concatenates file EMPDATA to EMPLOYEE. This concatenated file becomes the OLD file in the MATCH.
4. Creates the NEW file in the MATCH.
5. Uses an AS phrase to change the name of the sort field in the NEW file to the same name as the sort field in the OLD file.
6. Defines the merge procedure. All records from the NEW file, the OLD file, and both files are included in the final HOLD file.
7. Prints the values from the merged file.

The first page of output is:

SSN	CURRENT	FIRST	EXPENSES
---	-----	-----	-----
000000010	\$55,500.00	DANIEL	2,300.00
000000020	\$62,500.00	MICHAEL	.
000000030	\$70,000.00	LOIS	2,600.00
000000030	\$70,000.00	LOIS	2,300.00
000000040	\$62,500.00	RUTH	3,400.00
000000050	\$54,100.00	PETER	3,300.00
000000060	\$55,500.00	DORINA	.
000000070	\$83,000.00	EVELYN	.
000000080	\$43,400.00	PAMELA	3,200.00
000000080	\$43,400.00	PAMELA	3,350.00
000000090	\$33,000.00	MARIANNE	.
000000100	\$32,400.00	TIM	3,100.00
000000110	\$19,300.00	ANTHONY	1,800.00

000000110	\$19,300.00	ANTHONY	2,500.00
000000110	\$19,300.00	ANTHONY	2,400.00
000000120	\$49,500.00	KATE	2,200.00
000000130	\$62,500.00	MARCUS	.

Merging Concatenated Data Sources Without a Common Sort Field

In this example, the merged data sources do not share a sort field:

```

DEFINE FILE EMPDATA
CURR_SAL/D12.2M = CSAL;
FIRST_NAME/A10 = FN;
EID/A9 = PIN;
END

-*Start MATCH

MATCH FILE EMPLOYEE
SUM CURR_SAL AS 'CURRENT'
    FIRST_NAME AS 'FIRST'
BY EID AS 'SSN'

-*Concatenate EMPDATA to EMPLOYEE to form the first MATCH answer set

MORE
FILE EMPDATA
RUN

-*Second MATCH answer set:

FILE TRAINING
PRINT EXPENSES
BY PIN AS 'EID'
AFTER MATCH HOLD OLD-OR-NEW
END

-*Print merged file:

TABLE FILE HOLD
PRINT *
END

```

The AS phrase changes the answer set. Since the sort fields no longer have the same names, the fields are merged with no regard to matching records.

The first page of output is:

SSN	CURRENT	FIRST	EID	EXPENSES
---	-----	-----	---	-----
000000010	\$55,500.00	DANIEL	000000010	2,300.00
000000020	\$62,500.00	MICHAEL	000000030	2,600.00
000000030	\$70,000.00	LOIS	000000030	2,300.00
000000040	\$62,500.00	RUTH	000000040	3,400.00
000000050	\$54,100.00	PETER	000000050	3,300.00
000000060	\$55,500.00	DORINA	000000080	3,200.00
000000070	\$83,000.00	EVELYN	000000080	3,350.00
000000080	\$43,400.00	PAMELA	000000100	3,100.00
000000090	\$33,000.00	MARIANNE	000000110	1,800.00
000000100	\$32,400.00	TIM	000000110	2,500.00
000000110	\$19,300.00	ANTHONY	000000110	2,400.00
000000120	\$49,500.00	KATE	000000120	2,200.00
000000130	\$62,500.00	MARCUS	000000140	3,600.00
000000140	\$62,500.00	VERONICA	000000150	3,400.00
000000150	\$40,900.00	KARL	000000160	1,000.00
000000160	\$62,500.00	ROSE	000000180	1,250.00
000000170	\$30,800.00	WILLIAM	000000190	3,150.00

Cartesian Product

Cartesian product enables you to generate a report containing all combinations of non-related records or data instances in a multi-path request. This means that if a parent segment has three child instances on one path and two child instances on another path, when CARTESIAN is ON a request that references the parent segment and both children generates 16 records. When CARTESIAN is OFF, the same request generates only three records.

For related information about controlling how selection tests are applied to child segments on independent paths, see [Selecting Records for Your Report](#).

Enable/Disable Cartesian Product

```
SET CARTESIAN = {OFF|ON}
```

where:

OFF

Disables Cartesian product. OFF is the default setting.

ON

Enables Cartesian product and generates all possible combinations of non-related records.

SET CARTESIAN may also be issued within a request.

Usage Notes for Cartesian Product

- Cartesian product is performed on the lowest segment common to all paths, whether or not a field in that segment is referenced.
- Short paths do not display in requests with Cartesian product.
- The SET CARTESIAN parameter is disabled when ACROSS is specified, and a warning message is issued.
- The SUM display command and the TOT. prefix operator have no effect on Cartesian product.
- SUM, COMPUTE, and WITHIN in combination with the PRINT display command are performed on the Cartesian product.
- ON TABLE COLUMN-TOTAL is automatically generated on the Cartesian product.
- NOSPLIT is disabled if specified in combination with the SET CARTESIAN parameter, and no warning message is issued.
- MATCH is not supported with the SET CARTESIAN parameter. A warning message is not issued if MATCH is requested, and the request is processed as if CARTESIAN is set to OFF.

- TABLEF is not supported with the SET CARTESIAN parameter.

Reporting With Cartesian Product

When CARTESIAN is set to ON, the following multi-path request produces a report containing all possible combinations of models and standards for each car:

```
SET CARTESIAN=ON
TABLE FILE CAR
PRINT MODEL STANDARD
BY CAR
IF CAR EQ 'JAGUAR'
END
```

The output in an EBCDIC environment is:

CAR	MODEL	STANDARD
---	-----	-----
JAGUAR	V12XKE AUTO	POWER STEERING
	V12XKE AUTO	RECLINING BUCKET SEATS
	V12XKE AUTO	WHITEWALL RADIAL PLY TIRES
	V12XKE AUTO	WRAP AROUND BUMPERS
	V12XKE AUTO	4 WHEEL DISC BRAKES
	XJ12L AUTO	POWER STEERING
	XJ12L AUTO	RECLINING BUCKET SEATS
	XJ12L AUTO	WHITEWALL RADIAL PLY TIRES
	XJ12L AUTO	WRAP AROUND BUMPERS
	XJ12L AUTO	4 WHEEL DISC BRAKES

When CARTESIAN is set to OFF (the default), the same request results in a report from the CAR data source containing a list of models and standards without logical relationships.

The output in an EBCDIC environment is:

CAR	MODEL	STANDARD
---	-----	-----
JAGUAR	V12XKE AUTO	POWER STEERING
	XJ12L AUTO	RECLINING BUCKET SEATS
	.	WHITEWALL RADIAL PLY TIRES
	.	WRAP AROUND BUMPERS
	.	4 WHEEL DISC BRAKES

Improving Report Processing

The following high-performance methods optimize data retrieval and report processing:

- Temporary rotation of network and hierarchical data sources to create an alternate view of the data.
- Automatic alternate file views with the AUTOPATH feature.
- Automatic indexed retrieval (AUTOINDEX).
- Retrieval of pre-sorted data using the TABLEF command.
- Preserving the internal matrix of a report using the SAVEMATRIX parameter.
- Compiling expressions into machine code to provide faster processing.

i Note: These techniques may not be available for all data sources. See your data adapter documentation to determine if a technique is valid for your data source.

Rotating a Data Structure for Enhanced Retrieval

If you are using certain network or hierarchical data sources such as IMS, CA-IDMS/DB, or FOCUS, you can rotate the data source, creating an alternate view which changes some of the segment relationships and enables you to access the segments in a different order. By reporting from an alternate view, you can do the following:

- Change the access path. For example, you can access data in a lower segment more quickly by promoting that segment to a higher level.
- Change the path structure of a data source. This option is especially helpful if you wish to create a report using several sort fields that are on different paths in the file. By changing the view of the file hierarchy, all the desired sort fields can be on the same path.

It should be noted that retrieval is controlled by the minimum referenced subtree. For more information, see *Understanding the Efficiency of the Minimum Referenced Subtree* in the *Describing a Group of Fields* chapter in the *ibi™ FOCUS® Describing Data* manual.

For example, consider the regular and alternate views below:

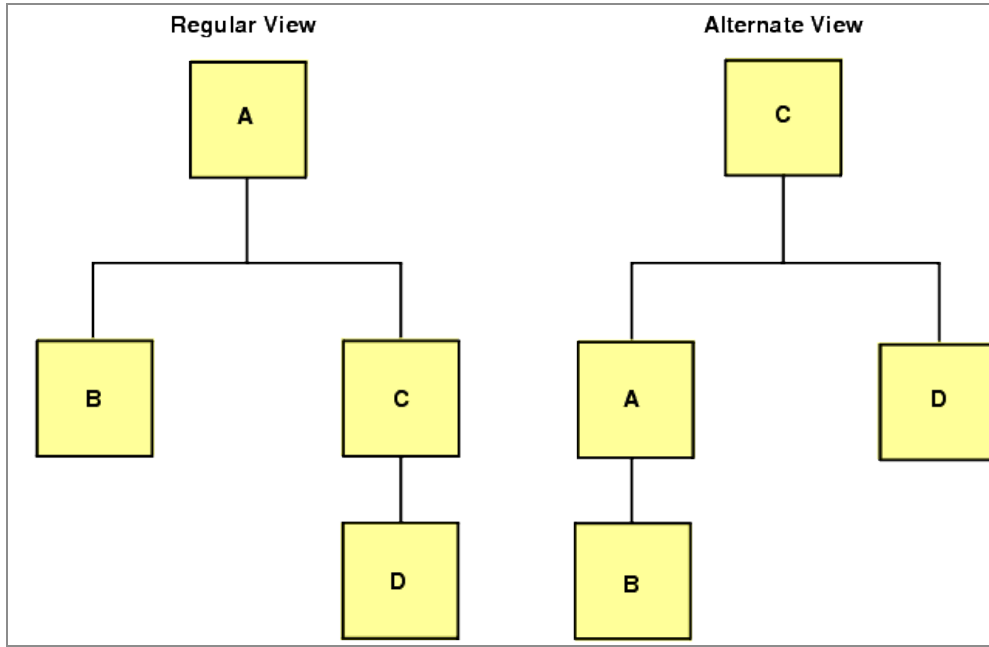

Since C is the root segment in the alternate view, particular instances of C can be selected faster.

Request an Alternate View

To request an alternate view, add the name of a field found in the alternate root segment to the file name in the TABLE command, separated by a period (.):

```
TABLE FILE filename.fieldname
```

Usage Notes for Restructuring Data

- If you use a non-indexed field, each segment instance is retrieved until the specified

record is found. Therefore, this process is less efficient than using an indexed field.

- When you use the alternate view feature on a particular child segment, the data retrieved from that segment is retrieved in physical order, not logical order. This is because the child becomes a root segment for the report request, and there are no logical pointers between the child segments of different parents.
- Alternate view on an indexed field is a special case that uses the index for retrieval. When you perform an alternate view on an indexed field, you enhance the speed of retrieval. However, you must include an equality test on the indexed field, for example `WHERE (MONTH EQ 1) OR (MONTH EQ 2)`, in order to benefit from the performance improvement.
- A field name specified in an alternate file view may not be qualified or exceed 12 characters.
- Automatic Indexed Retrieval (AUTOINDEX) is never invoked in a TABLE request against an alternate file view.

Restructuring Data

Consider the following data structure, in which `PROD_CODE` is an indexed field:

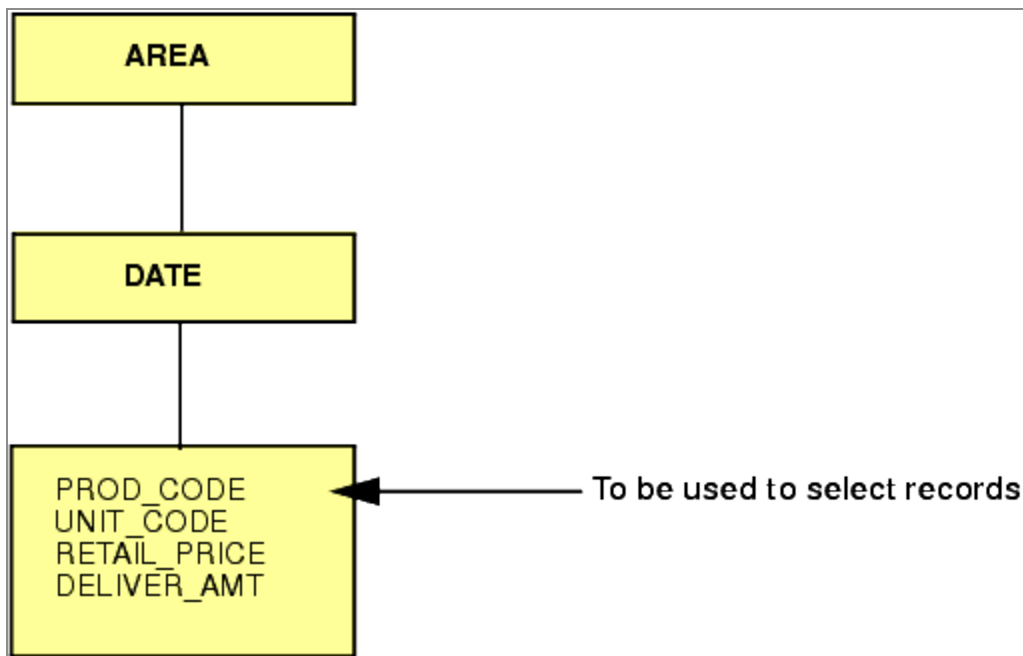

You could issue the following request to promote the segment containing PROD_CODE to the top of the hierarchy, thereby enabling quicker access to the data in that segment.

```
TABLE FILE SALES.PROD_CODE
"SALES OF B10 DISTRIBUTED BY AREA"
SUM UNIT_SOLD AND RETAIL_PRICE
BY AREA
WHERE PROD_CODE EQ 'B10'
ON TABLE COLUMN-TOTAL
END
```

Optimizing Retrieval Speed for ibi FOCUS Data Sources

When the AUTOPATH parameter is set ON, an optimized retrieval path—that is, one in which the lowest retrieved segment is the entry point—is selected dynamically. It is equivalent to the alternate view syntax

```
TABLE FILE filename.fieldname
```

where:

fieldname

Is not indexed. Retrieval starts at the segment in which *fieldname* resides.

The system determines whether optimized retrieval is appropriate by analyzing the fields referenced in a request and the data source structure. For more information on the AUTOPATH parameter, see the *ibi™ WebFOCUS® Developing Reporting Applications* manual.



Tip: Another way to optimize data retrieval is by using intelligent partitioning in requests that do not require retrieval from every partition. For information on efficiency considerations for FOCUS data sources, including intelligent partitioning, see the *ibi™ FOCUS® Describing Data* manual.

Automatic Indexed Retrieval

Automatic indexed retrieval (AUTOINDEX) optimizes the speed of data retrieval in FOCUS data sources. To take advantage of automatic indexed retrieval, a TABLE request must contain an equality or range test on an indexed field in the highest segment referenced in the request.

This method is not supported if a:

- Range test applies to a packed data value.
- Request specifies an alternate view (that is, TABLE FILE *filename.fieldname*).
- Request contains the code BY HIGHEST or BY LOWEST.

For related information on AUTOINDEX, see the *Developing Applications* manual.

Use Indexed Retrieval

```
SET AUTOINDEX = {ON|OFF}
```

where:

ON

Uses indexed data retrieval for optimized speed when possible. The request must contain an equality or range test on an indexed field in the highest segment referenced in the request. ON is the default value.

OFF

Uses sequential data retrieval unless a request specifies an indexed view (TABLE FILE *filename.indexed_fieldname*) and contains an equality test on *indexed_fieldname*. In that case, indexed data retrieval is automatically performed.

Usage Notes for Indexed Retrieval

- AUTOINDEX is never invoked when the TABLE request contains an alternate file view

(that is, TABLE FILE *filename.fieldname*).

- Even if AUTOINDEX is ON, indexed retrieval is not performed when the TABLE request contains BY HIGHEST or BY LOWEST phrases.
- When a request specifies an indexed view (as in TABLE FILE *filename.indexed_fieldname*), indexed retrieval is implemented under the following circumstances:
 - AUTOINDEX is OFF and the request contains an equality test on the indexed field.
 - AUTOINDEX is ON and the request contains either an equality or a range (FROM ... TO) test against the indexed field.

Using Indexed Retrieval

The following Master File is referenced in the examples that follow:

```
FILENAME=SALES, SUFFIX=FOC,
  SEGNAME=STOR_SEG, SEGTYPE=S1,
    FIELDNAME=AREA, ALIAS=LOC, FORMAT=A1, $
  SEGNAME=DATE_SEG, PARENT=STOR_SEG, SEGTYPE=SH1,
    FIELDNAME=DATE, ALIAS=DTE, FORMAT=A4MD, $
  SEGNAME=DEPT, PARENT=DATE_SEG, SEGTYPE=S1,
    FIELDNAME=DEPARTMENT, ALIAS=DEPT, FORMAT=A5, FIELDTYPE=I, $
    FIELDNAME=DEPT_CODE, ALIAS=DCODE, FORMAT=A3, FIELDTYPE=I, $
    FIELDNAME=PROD_TYPE, ALIAS=PTYPE, FORMAT=A10, FIELDTYPE=I, $
  SEGNAME=INVENTORY, PARENT=DEPT, SEGTYPE=S1, $
    FIELDNAME=PROD_CODE, ALIAS=PCODE, FORMAT=A3, FIELDTYPE=I, $
    FIELDNAME=UNIT_SOLD, ALIAS=SOLD, FORMAT=I5, $
    FIELDNAME=RETAIL_PRICE, ALIAS=RP, FORMAT=D5.2M, $
    FIELDNAME=DELIVER_AMT, ALIAS=SHIP, FORMAT=I5, $
```

The following procedure contains an equality test on DEPT_CODE and PROD_CODE. DEPT_CODE is used for indexed retrieval since it is in the higher of the referenced segments.

```
SET AUTOINDEX=ON
TABLE FILE SALES
SUM UNIT_SOLD RETAIL_PRICE
IF DEPT_CODE EQ 'H01'
IF PROD_CODE EQ 'B10'
END
```

If your TABLE request contains an equality or range test against more than one indexed field in the same segment, AUTOINDEX uses the first index referenced in that segment for retrieval. The following stored procedure contains an equality test against two indexed fields. Since DEPT_CODE appears before PROD_TYPE in the Master File, AUTOINDEX uses DEPT_CODE for retrieval.

```
SET AUTOINDEX=ON
TABLE FILE SALES
SUM UNIT_SOLD AND RETAIL_PRICE
IF PROD_TYPE EQ 'STEREO'
IF DEPT_CODE EQ 'H01'
END
```

Indexed retrieval is not invoked if the equality or range test is run against an indexed field that does not reside in the highest referenced segment. In the following example, indexed retrieval is not performed, because the request contains a reference to AREA, a field in the STOR_SEG segment:

```
SET AUTOINDEX=ON
TABLE FILE SALES
SUM UNIT_SOLD AND RETAIL_PRICE
BY AREA
IF PROD_CODE EQ 'B10'
IF PROD_TYPE EQ 'STEREO'
END
```

Data Retrieval Using TABLEF

TABLEF is a variation of the TABLE command that provides a fast method of retrieving data that is already stored in the order required for printing and requires no additional sorting.

Using TABLEF, records are retrieved in the logical sequence from the data source. The standard report request syntax applies, subject to the following rules:

- Any BY phrases must be compatible with the logical sequence of the data source. BY phrases are used only to establish control breaks, not to change the order of the records.
- ACROSS phrases are not permitted.
- Multiple display commands are not permitted. Only one display command may be

used.

- After the report is executed, RETYPE, HOLD, and SAVE are not available. However, you can produce an extract file if you include ON TABLE HOLD or ON TABLE SAVE as part of the request.
- NOSPLIT is not compatible with the TABLEF command, and produces a FOC037 error message.
- TABLEF can be used with HOLD files and other non-FOCUS data sources when the natural sort sequence of both the request and the data are the same.
- The DST. prefix operator is not permitted.
- BORDER styling is not supported with TABLEF.
- TABLEF is not supported with SQUEEZE.

Printing Using Fast Table Retrieval

If you previously created a HOLD file from the EMPLOYEE data source, sorted by the CURR_SAL, LAST_NAME, and FIRST_NAME fields, you can issue the following TABLEF request:

```
TABLEF FILE HOLD
PRINT CURR_SAL AND LAST_NAME AND FIRST_NAME
END
```

Preserving the Internal Matrix of Your Last Report

An internal matrix is generated with each TABLE, FML, GRAPH, and MATCH request. These requests are available for the duration of your session, or until you generate a new report or graph that overwrites it.

While a report (or graph) request is available, you can:

- Extract and save data from it using the HOLD, SAVE, and SAVB commands.
- Redisplay it using the RETYPE or REPLOT commands.

If you wish to save the matrix from your last request to protect it from being overwritten when using Dialogue Manager commands, you can activate the SET SAVEMATRIX feature.

i Note: SET SAVEMATRIX is not available with the TABLEF command.

Save an Internal Matrix

```
SET SAVEMATRIX = {ON|OFF}
```

where:

ON

Saves the internal matrix from the last report request, preventing it from being overwritten.

OFF

Overwrites the internal matrix for each request. OFF is the default value.

Saving the Internal Matrix of a Report

The following request creates a report, then executes a procedure that contains a Dialogue Manager command (which would otherwise overwrite the internal matrix), and recalls the report using the RETYPE command:

```
SET SAVEMATRIX = ON
TABLE FILE EMPLOYEE
.
.
.
END
EX DMFEX
RETYPE
```

Compiling Expressions

Compiling expressions into machine code provides faster processing.

Compiling Expressions Using the DEFINES Parameter

The SET DEFINES, SET COMPUTE, and SET MODCOMPUTE commands have been deprecated. Expressions are compiled unless environmental conditions prevent compilation.

Among the benefits of the compiling expressions are:

- Compilation of only those expressions that are actually used in the TABLE request.
- Much faster execution of expressions containing complex calculations on long packed fields.
- Compilation of date expressions.

Usage Notes for Compiled Expressions

- Any expression that cannot be compiled runs without compilation. This does not affect the compilation of other expressions. The following elements in an expression disable compilation:
 - Functions. However, expressions that use the following functions can be compiled: YMD, DMY, INT, and DECODE.
 - CONTAINS, OMITS, LAST.

If compilation is not possible because of environmental conditions, the processing is handled without compilation. No message is generated indicating that compilation did not take place. To determine whether it did take place, issue the ? COMPILE command.

Creating Financial Reports With Financial Modeling Language (FML)

The Financial Modeling Language (FML) is designed for the special needs associated with creating, calculating, and presenting financially oriented data, such as balance sheets, consolidations, or budgets. These reports are distinguished from other reports because calculations are inter-row, as well as inter-column, and each row or line represents a unique entry or series of entries that can be aggregated directly from the input data or calculated as a function of the data.

Reporting With FML

FML is an integrated extension of the TABLE command. By adding the FOR phrase and the RECAP command, you can handle an expanded range of applications.

i Note: MORE is not supported in FML requests.

In conjunction with Dialogue Manager, FML can evaluate "what if" scenarios and develop complete decision support systems. These systems can take advantage of business intelligence features, such as statistical analysis and graphics, in addition to standard financial statements.

Procedures using FML are not hard-wired to the data. As in any other report request, they can easily be changed. FML includes the following facilities:

- **Row and column formatting.** You can specify results in a row-by-row, column-by-column fashion. For more information, see [Performing Inter-Row Calculations](#).
- **Intermediate results.** You can post FML results to an external file and pick them up at a later time for analysis. This is useful when intermediate results are developed and a final procedure consolidates the results later. For more information, see [Saving and Retrieving Intermediate Report Results](#).
- **Inline data entry.** FML enables you to specify constants from within the procedure,

in addition to the data values retrieved from your data source. For more information, see [Supplying Data Directly in a Request](#).

- **Recursive reporting.** You can produce reports where the results from the end of one-time period or column become the starting balance in the next. For example, you can use recursive reports to produce a cash flow projection. For more information, see [Creating a Recursive Model](#).
- **Dynamic reporting from a chart of accounts or a similar hierarchy of information.** You can create a report that changes as the organization of information changes, ensuring that you automatically retrieve information that reflects the latest structure and its values. There is no need to alter either the Master File or the report request. For more information, see [Reporting Dynamically From a Hierarchy](#).

Sample FML Request

This example produces a simple asset sheet, contrasting the results of two years. It illustrates many key features of the Financial Modeling Language (FML). Numbers to the left of the procedure lines correspond to explanations that follow the request.

```

TABLE FILE FINANCE
HEADING CENTER
"COMPARATIVE ASSET SHEET </2"
SUM AMOUNT ACROSS HIGHEST YEAR
WHERE YEAR EQ '1983' OR '1982'
1. FOR ACCOUNT
2. 1000          AS 'UTILITY PLANT'          LABEL    UTP
OVER
2. 1010 TO 1050 AS 'LESS ACCUMULATED DEPRECIATION' LABEL    UTPAD
OVER
3. BAR
OVER
4. RECAP UTPNET = UTP-UTPAD; AS 'TOTAL PLANT-NET'
OVER
   BAR
OVER
   2000 TO 3999 AS 'INVESTMENTS'          LABEL    INV
OVER
5. "CURRENT ASSETS"
OVER
   4000          AS 'CASH'                LABEL    CASH
OVER

```

```

    5000 TO 5999 AS 'ACCOUNTS RECEIVABLE-NET'      LABEL  ACR
OVER
    6000          AS 'INTEREST RECEIVABLE'        LABEL  ACI
OVER
    6500          AS 'FUEL INVENTORY'            LABEL  FUEL
OVER
    6600          AS 'MATERIALS AND SUPPLIES'     LABEL  MAT
OVER
    6900          AS 'OTHER'                     LABEL  MISC
OVER
    BAR
OVER
    RECAP TOTCAS=CASH+ACR+ACI+FUEL+MAT+MISC;AS 'TOTAL CURRENT ASSETS'
OVER
    BAR
OVER
    7000          AS 'DEFERRED DEBITS'           LABEL  DEFDB
OVER

```

```

    BAR
OVER
6. RECAP TOTAL = UTPNET+INV+TOTCAS+DEFDB; AS 'TOTAL ASSETS'
OVER
    BAR AS '='
    FOOTING
    "</2 *** PRELIMINARY ASSET SHEET BASED ON UNAUDITED FIGURES ***"
    END

```

1. FOR and OVER are FML phrases that enable you to structure the report on a row-by-row basis.
2. LABEL assigns a variable name to a row item for use in a RECAP calculation.
1000 and 1010 TO 1050 are tags that identify the data values of the FOR field, ACCOUNT in the FINANCE data source. A report row can be associated with a tag that represents a single data value (like 1000), multiple data values, or a range of values (like 1010 TO 1050).
3. BAR enables you to underline a column of numbers before performing a RECAP calculation.
4. The RECAP command creates a new value based on values already identified in the report with LABEL. In this case, the value UTPNET is derived from UTP and UTPAD and is renamed TOTAL PLANT-NET with an AS phrase to provide it with greater

meaning in the report.

5. Free text can be incorporated at any point in an FML report, similar to underlines.
6. Notice that this RECAP command derives a total (TOTAL ASSETS) from values retrieved directly from the data source, and from values derived from previous RECAP computations (UTPNET and TOTCAS).

The output is shown as follows.

PAGE	1	COMPARATIVE ASSET SHEET	
		YEAR	
		1983	1982

UTILITY PLANT		1,430,903	1,294,611
LESS ACCUMULATED DEPRECIATION		249,504	213,225
		-----	-----
TOTAL PLANT-NET		1,181,399	1,081,386
		-----	-----
INVESTMENTS		818	5,639
CURRENT ASSETS			
CASH		4,938	4,200
ACCOUNTS RECEIVABLE-NET		28,052	23,758
INTEREST RECEIVABLE		15,945	10,206
FUEL INVENTORY		35,158	45,643
MATERIALS AND SUPPLIES		16,099	12,909
*** PRELIMINARY ASSET SHEET BASED ON UNAUDITED FIGURES ***			

PAGE	2	COMPARATIVE ASSET SHEET	
		YEAR	
		1983	1982

OTHER		1,264	1,743
		-----	-----
TOTAL CURRENT ASSETS		101,456	98,459
		-----	-----
DEFERRED DEBITS		30,294	17,459
		-----	-----
TOTAL ASSETS		1,313,967	1,202,943
		=====	=====
*** PRELIMINARY ASSET SHEET BASED ON UNAUDITED FIGURES ***			

COMPARATIVE ASSET SHEET		
	YEAR	
	1983	1982
UTILITY PLANT	1,430,903	1,294,611
LESS ACCUMULATED DEPRECIATION	249,504	213,225
TOTAL PLANT-NET	1,181,399	1,081,386
INVESTMENTS	818	5,639
CURRENT ASSETS		
CASH	4,938	4,200
ACCOUNTS RECEIVABLE-NET	28,052	23,758
INTEREST RECEIVABLE	15,945	10,206
FUEL INVENTORY	35,158	45,643
MATERIALS AND SUPPLIES	16,099	12,909
OTHER	1,264	1,743
TOTAL CURRENT ASSETS	101,456	98,459
DEFERRED DEBITS	30,294	17,459
TOTAL ASSETS	1,313,967	1,202,943
*** PRELIMINARY ASSET SHEET BASED ON UNAUDITED FIGURES ***		

Creating Rows From Data

A normal TABLE request sorts rows of a report according to the BY phrase you use. The data retrieved is sorted from either low-to-high or high-to-low, as requested. The rows may be limited by a screening phrase to a specific subset, but:

- They appear in a sort order.
- Rows appear only for values that are retrieved from the file.
- You can only insert free text between rows when a sort field changes value, such as:

```
ON DIVISION SUBFOOT
```

- You can only insert calculations between rows when a sort field changes value, such as:

```
ON DIVISION RECAP
```

In contrast, the FML FOR phrase creates a matrix in which you can structure your report row-by-row. This organization gives you greater control over the data that is incorporated into a report, and its presentation. You can:

- Report on specific data values for a field in a data source and combine particular data values under a common label, for use in calculations.
- Type data directly into the request to supplement data retrieved from the data source.
- Include text, underlines, and calculations at points in the report that are not related to sort breaks.
- Perform recursive processing, in which the result of an interim calculation is saved and then used as the starting point for a subsequent calculation.
- Suppress the display of rows for which no data is retrieved.
- Identify rows by labels and columns by numbers, addresses, and values so that you can point to the individual cells formed at each intersection (as on a spreadsheet).

Retrieve FOR Field Values From a Data Source

The syntax for specifying rows is:

```
FOR fieldname [AS 'coltitle'] value [OR value OR...] [AS 'text']
[LABEL label] OVER
.
.
.
[value [OR value ...]] [AS 'text'] [LABEL label]
END
```

where:

fieldname

Is the FOR field for the FML report.

coltitle

Is the column title for the FOR field on the report output.

value

Is the value (also known as a tag value) describing the data that is retrieved for this row of the report.

AS 'text'

Enables you to assign a name to a tag value, which replaces the tag value in the output. Enclose the text in single quotation marks.

label

Assigns a label to the row for reference in a RECAP expression. The label can be up to 66 characters and cannot have blanks or special characters. Each explicit label you assign must be unique.

Even if you assign an explicit label, the positional label (R1, R2, and so on) is retained internally.

By default, a tag value for a FOR field (like 1010) may be added only once to the FML matrix. However, if you wish to add the same value of a FOR field to the matrix more than once, you can turn on the FORMULTIPLE parameter (the default setting is OFF). For more information, see [Use the Same FOR Field Value in Multiple Rows](#).

For more information about the FMLFOR, FMLLIST, and FMLINFO functions that return the tag values used in an FML request, see the *ibi™ WebFOCUS® Using Functions* manual.

Creating Rows From Values in a Data Source

Assume you have a simple data source with financial data for each corporate account, as follows:

CHART OF ACCOUNTS	
ACCOUNT	DESCRIPTION

```

1010      CASH ON HAND
1020      DEMAND DEPOSITS
1030      TIME DEPOSITS
1100      ACCOUNTS RECEIVABLE
1200      INVENTORY
.
.
.

```

Using the FOR phrase in FML, you can issue the following TABLE request in which each value of ACCOUNT is represented by a tag (1010, 1020, and so on), and displays as a separate row:

```

TABLE FILE LEDGER
SUM AMOUNT
FOR ACCOUNT
1010 OVER
1020 OVER
1030 OVER
1100 OVER
1200
END

```

The output is shown as follows.

```

          AMOUNT
          -----
1010      8,784
1020      4,494
1030      7,961
1100     18,829
1200     27,307

```

Creating Rows From Multiple Records

There are different ways to combine multiple values from your data sources into an FML report row. You can use:

- The OR phrase to sum the values of two or more tags in a single expression. For more information, see [Sum Values in Rows With the OR Phrase](#).

- The TO phrase to identify a range of tag values on which to report. For more information, see [Identify a Range of Values With the TO Phrase](#).
- A mask to specify a group of tag values without having to name each one. For more information, see [Use Masking Characters to Retrieve Tag Values](#).

By default, a FOR field value can only be included in a single row of an FML matrix. However, by turning on the FORMULTIPLE parameter, you can include the same data value in multiple rows in the FML matrix. For example, the same value can exist as a solitary value in one row, be part of a range in another row, and be used in a calculation in a third row. For more information, see [Use the Same FOR Field Value in Multiple Rows](#).

In addition to these methods, you can extract multiple tags for a row from an external file.

Sum Values in Rows With the OR Phrase

To sum the values of two or more tags in a single report row, use the OR phrase in the FOR phrase. The syntax is:

```
FOR fieldname
value1 OR value2 [OR valuen...] [AS 'text'] [LABEL label] [OVER]
.
.
.
```

where:

fieldname

Is a field name in the data source.

value1, value2, valuen

Are the tag values to be retrieved and summed.

AS 'text'

Assigns a title to the combined tag values. Enclose the text in single quotation marks (').

label

Assigns a label to the row for reference in a RECAP expression. The label can be up to 66 characters and cannot have blanks or special characters. Each explicit label you assign

must be unique.

Even if you assign an explicit label, the positional label (R1, R2, and so on) is retained internally.

Summing Values in Rows

The following model sums the values of three tags (1010, 1020, 1030) as CASH.

```
TABLE FILE LEDGER
SUM AMOUNT FOR ACCOUNT
1010 OR 1020 OR 1030 AS 'CASH' OVER
1100 AS 'ACCOUNTS RECEIVABLE' OVER
1200 AS 'INVENTORY'
END
```

The output is shown as follows.

	AMOUNT

CASH	21,239
ACCOUNTS RECEIVABLE	18,829
INVENTORY	27,307

Identify a Range of Values With the TO Phrase

To sum the values of a range of tags in a single report row, use the TO phrase in the FOR phrase. The syntax is:

```
FOR fieldname
value1 TO value2 [AS 'text'] [LABEL label] [OVER]
```

where:

fieldname

Is a field name in the data source.

value1

Is the tag value at the lower limit of the range.

TO

Is the required phrase.

value2

Is the tag value at the upper limit of the range.

AS 'text'

Assigns a title to the combined tag values. Enclose the text in single quotation marks (').

label

Assigns a label to the row for reference in a RECAP expression. The label can be up to 66 characters and cannot have blanks or special characters. Each explicit label you assign must be unique.

Even if you assign an explicit label, the positional label (R1, R2, and so on) is retained internally.

Identifying a Range of Values

Since CASH accounts in the LEDGER system are identified by the tags 1010, 1020, and 1030, you can specify the range 1010 to 1030:

```
TABLE FILE LEDGER
SUM AMOUNT FOR ACCOUNT
1010 TO 1030 AS 'CASH'
END
```

Use Masking Characters to Retrieve Tag Values

If the tag field has a character (alphanumeric) format, you can perform a masked match. Use the dollar sign character (\$) as the mask. For instance,

```
A$D
```

matches any four-character value beginning with A and ending with D. The two middle places can be any character. This is useful for specifying a whole group of tag values without having to name each one.

Using Masking Characters to Match a Group of Tags

In this example, the amounts associated with all four-character accounts that begin with 10, expressed with a mask as 10\$\$, are used to produce the CASH row of the report.

```
TABLE FILE LEDGER
SUM AMOUNT FOR ACCOUNT
10$$ AS 'CASH'          OVER
1100 AS 'ACCOUNTS RECEIVABLE' OVER
1200 AS 'INVENTORY'
END
```

The output is shown as follows.

	AMOUNT

CASH	21,239
ACCOUNTS RECEIVABLE	18,829
INVENTORY	27,307

Use the Same FOR Field Value in Multiple Rows

You can use the same value of a FOR field in many separate rows (whether alone, as part of a range, or in a calculation) by including the following syntax before or within an FML request.

```
SET FORMULTIPLE={ON|OFF}
```

or

```
ON TABLE SET FORMULTIPLE {ON|OFF}
```

where:

ON

Enables you to reference the same value of a FOR field in more than one row in an FML request.

With FORMULTIPLE set to ON, a value retrieved from the data source is included on every line in the report output for which it matches the tag references.

OFF

Does not enable you to include the same value in multiple rows. OFF is the default value.

With FORMULTIPLE set to OFF, multiple tags referenced in any of these ways (OR, TO, *) are evaluated first for an exact reference or for the end points of a range, then for a mask, and finally within a range. For example, if a value is specified as an exact reference and then as part of a range, the exact reference is displayed. Note that the result is unpredictable if a value fits into more than one row whose tags have the same priority (for example, an exact reference and the end point of a range).

For more information, see [Reporting Dynamically From a Hierarchy](#).

Referencing the Same Value in More Than One Row

This request retrieves the tag values for accounts 1010, 1020, and 1030, and lists the corresponding values individually. It then aggregates the same values and displays the sum as TOTAL CASH. Similarly, the tag values for accounts 1100 and 1200 displays as detail items, and then summarized as TOTAL NON-CASH ASSETS.

```

SET FORMULTIPLE=ON
TABLE FILE LEDGER
SUM AMOUNT
FOR ACCOUNT
1010 AS 'CASH ON HAND'           OVER
1020 AS 'DEMAND DEPOSITS'       OVER
1030 AS 'TIME DEPOSITS'         OVER
BAR                               OVER
1010 OR 1020 OR 1030 AS 'TOTAL CASH' OVER
" "                               OVER
1100 AS 'ACCOUNTS RECEIVABLE'   OVER
1200 AS 'INVENTORY'             OVER
BAR                               OVER

```

```
1100 TO 1200 AS 'TOTAL NON-CASH ASSETS'
END
```

The output is shown as follows.

	AMOUNT

CASH ON HAND	8,784
DEMAND DEPOSITS	4,494
TIME DEPOSITS	7,961

TOTAL CASH	21,239
ACCOUNTS RECEIVABLE	18,829
INVENTORY	27,307

TOTAL NON-CASH ASSETS	46,136

Using Tags From External Files

In this example, the values for a row of the FML report come from an external file called CASHSTUF, which contains the following tags.

```
1010
1020
1030
```

The following TABLE request uses the tag values from the external file, summing the amounts in accounts 1010, 1020, and 1030 into the CASH row of the FML report.

```
TABLE FILE LEDGER
SUM AMOUNT FOR ACCOUNT
(CASHSTUF) AS 'CASH' OVER
1100 AS 'ACCOUNTS RECEIVABLE'
END
```

Notice that the file name must be enclosed in parentheses.

Using the BY Phrase in FML Requests

Only one FOR phrase is permitted in a TABLE request. It substitutes in part for a BY phrase, which controls the sort sequence. However, the request can also include up to 32 BY phrases. In general, BY phrases specify the major (outer) sort fields in FML reports, and the FOR phrase specifies the minor (inner) sort field. Note that the BY ROWS OVER phrase is not supported in a request that uses the FOR phrase.

Combining BY and FOR Phrases in an FML Request

In this example, the report results for ACCOUNT (the inner sort field) are sorted by REGION (the outer sort field).

```

DEFINE FILE REGION
CUR_YR=E_ACTUAL;
LAST_YR=.831*CUR_YR;
REGION/A4=IF E_ACTUAL NE 0 OR E_BUDGET NE 0 THEN 'EAST' ELSE 'WEST';
END

TABLE FILE REGION
HEADING CENTER
"CURRENT ASSETS FOR REGION <REGION>"
" "
SUM CUR_YR LAST_YR
BY REGION NOPRINT
FOR ACCOUNT
10$$ AS 'CASH'                                OVER
1100 AS 'ACCOUNTS RECEIVABLE'                 OVER
1200 AS 'INVENTORY'                           OVER
BAR                                             OVER
RECAP CUR_ASSET/I5C = R1 + R2 + R3;
END

```

The output is shown as follows.

```

CURRENT ASSETS FOR REGION EAST
                                CUR_YR      LAST_YR
                                -----      -

```

CASH	9,511.00	7,903.64
ACCOUNTS RECEIVABLE	.	.
INVENTORY	.	.
	-----	-----
CUR_ASSET	9,511	7,903

A sort field value can be used in a RECAP command to allow the model to take different actions within each major sort break. For instance, the following calculation computes a non-zero value only for the EAST region.

```
RECAP X=IF REGION EQ 'EAST' THEN .25*CASH ELSE 0;
AS 'AVAILABLE FOR DIVIDENDS'
```

For more information, see [Performing Inter-Row Calculations](#).

Supplying Data Directly in a Request

In certain cases, you may need to include additional constants (such as exchange rates or inflation rates) in your model. Not all data values for the model have to be retrieved from the data source. Using FML, you can supply data directly in the request.

Supply Data Directly in a Request

```
DATA value,[..., value],$ [AS 'text'] [LABEL label] OVER
```

where:

value

Specifies the values that you are supplying. Values in a list must be separated by commas. The list must end with a comma and a dollar sign (,\$).

AS 'text'

Enables you to assign a title to the data row. Enclose the text in single quotation marks.

Without this entry, the row title is blank on the report.

label

Assigns a name to the data row for use in RECAP calculations. The label can be up to 66 characters and cannot have blanks or special characters. Each explicit label you assign must be unique.

Supplying Data Directly in a Request

In this example, two values (.87 and 1.67) are provided for the exchange rates of euros and pounds, respectively.

```

DEFINE FILE LEDGER
EUROS/I5C=AMOUNT;
POUNDS/I5C=3.2*AMOUNT;
END

TABLE FILE LEDGER
SUM EUROS AS 'EUROPE,DIVISION'
POUNDS AS 'ENGLISH,DIVISION'
FOR ACCOUNT
1010 AS 'CASH--LOCAL CURRENCY' LABEL CASH          OVER
DATA .87, 1.67 , $ AS 'EXCHANGE RATE' LABEL EXCH    OVER
RECAP US_DOLLARS/I5C = CASH * EXCH;
END

```

The values supplied are taken one column at a time for as many columns as the report originally specified.

The output is shown in the following image.

	EUROPE DIVISION -----	ENGLISH DIVISION -----
CASH--LOCAL CURRENCY	8,784	28,106
EXCHANGE RATE	.87	1.67
US_DOLLARS	7,642	46,937

	EUROPE <u>DIVISION</u>	ENGLISH <u>DIVISION</u>
CASH--LOCAL CURRENCY	8,784	28,108
EXCHANGE RATE	.87	1.67
US_DOLLARS	7,642	46,940

Performing Inter-Row Calculations

The RECAP command enables you to perform calculations on data in the rows of the report to produce new rows. You must supply the name and format of the value that results from the calculation, and an expression that defines the calculation you wish to perform. Since RECAP calculations are performed among rows, each row in the calculation must be uniquely identified. FML supplies default row labels for this purpose (R1, R2, and so on). However, you may assign more meaningful labels. For more information, see [Referring to Rows in Calculations](#).

Define Inter-Row Calculations

```
RECAP calcname[/format]=expression; [AS 'text']
```

where:

RECAP

Is the required command name. It should begin on a line by itself.

calcname

Is the name you assign to the calculated value. The name can be up to 66 characters long, and must start with an alphabetic character. This name also serves as an explicit label. For more information, see [Referring to Rows in Calculations](#).

format

Is the USAGE format of the calculated value. It cannot exceed the column width. The default is the format of the column in which the calculated value is displayed.

expression

Can be any calculation available with the DEFINE command (including IF ... THEN ... ELSE syntax, functions, like DECODE and EDIT, and fields in date format). The expression may extend to as many lines as it requires. A semicolon is required at the end of the expression. For more information, see [Using Functions in RECAP Calculations](#) and the *ibi™ WebFOCUS® Using Functions* manual.

The expression can include references to specific rows using the default FML positional labels (R1, R2, and so on), or it can refer to rows, columns, and cells using a variety of

flexible notation techniques. Note that **Rn** references can only be used for rows previously evaluated within the model. For more information, see [Referring to Rows in Calculations](#), [Referring to Columns in Calculations](#), and [Referring to Cells in Calculations](#).

AS 'text'

Changes the default title of the row. By default, the name of the RECAP value is displayed as the row title in output. The AS phrase replaces the default. Enclose the text in single quotation marks.

Usage Notes for RECAP

- RECAP expressions refer to other rows in the model by their labels (either explicit or default). Labels referred to in a RECAP expression must also be specified in the report request.
- The format specified for the RECAP result overrides the format of the column. In the following example,

```
RECAP TOTVAL/D6.2S=IF R1 GT R4 THEN R4 ELSE R1;
AS 'REDUCED VALUE'
```

TOTVAL/D6.2S displays the result as six positions with two decimal places (and displays blanks if the value was zero) in each column of the report, regardless of the format of the data in the column. This feature can be used to display percentages in a column of whole numbers.

- Subtotals are not supported in FML.
- In environments that support the RETYPE command, note that RETYPE does not recognize labels in FML with field format redefinition.
- **Rn** references (default positional row labels) can only be used for rows previously evaluated within the model.

Referring to Rows in Calculations

FML assigns a default positional label to each TAG, DATA, RECAP, and PICKUP row. These positional labels are automatically prefixed with the letter R, so that the first such row in

the model is R1, the second is R2, and so on. You can use these labels to refer to rows in RECAP expressions.

i Note: Default labels are not assigned to rows that contain underlines, blank lines, or free text, since these row types need not be referenced in expressions.

When you refer to rows in a RECAP expression, you can:

- Use the positional row label assigned by FML.
- Create an explicit row label of your own.

i Note: You should not create an explicit label with a name of the form **Rn**, as that type of name is used for default positional row labels assigned by FML and may cause problems with subsequent RECAPs.

- Mix positional and explicit row labels.

If you assign an explicit label, the positional label (R1, R2, and so on) is retained internally.

Note that an explicit label is not needed for a RECAP row, because the name of the calculated value on the left of the equal sign can be used as a label.

In addition to their role in RECAP calculations, you can use labels to format rows in an FML report. For more information, see [Formatting an FML Report](#).

Assign an Explicit Row Label

```
rowtype [AS 'text'] LABEL label [OVER]
```

where:

rowtype

Can be a TAG, DATA, or PICKUP row.

AS 'text'

Assigns a different name to the row for the report. Enclose the text in single quotation marks (').

label

Assigns a label to a row for reference in a RECAP expression or a StyleSheet declaration. The label can be up to 66 characters and cannot have blanks or special characters. Each explicit label you assign must be unique.

i Note: You should not create an explicit label with a name of the form R_n , as that type of name is used for the default positional row labels assigned by FML and may cause problems with subsequent RECAPs.

Even if you assign an explicit label, the positional label (R1, R2, and so on) is retained internally.

Referring to Default Row Labels in RECAP Expressions

In this example, FML assigns account 1010 the implicit label R1, account 1020, the implicit label R2, and account 1030, the implicit label R3. Since no label is assigned to a BAR row, the RECAP row is assigned the implicit label R4.

```
TABLE FILE LEDGER
SUM AMOUNT FOR ACCOUNT
1010 AS 'CASH ON HAND'      OVER
1020 AS 'DEMAND DEPOSITS'  OVER
1030 AS 'TIME DEPOSITS'    OVER
BAR                          OVER
RECAP TOTCASH = R1 + R2 + R3; AS 'TOTAL CASH'
END
```

The output is shown as follows.

	AMOUNT

CASH ON HAND	8,784
DEMAND DEPOSITS	4,494
TIME DEPOSITS	7,961

TOTAL CASH	21,239

Referring to Explicit Row Labels in RECAP Expressions

The following request assigns the labels CA, AR, and INV to three tag rows, which are referenced in the RECAP expression.

```
TABLE FILE LEDGER
SUM AMOUNT FOR ACCOUNT
10$$$ AS 'CASH'                LABEL CA    OVER
1100 AS 'ACCOUNTS RECEIVABLE' LABEL AR    OVER
1200 AS 'INVENTORY'           LABEL INV   OVER
BAR                             OVER
RECAP CURASST/I5C = CA + AR + INV;
END
```

The output is shown as follows.

	AMOUNT

CASH	21,239
ACCOUNTS RECEIVABLE	18,829
INVENTORY	27,307

CURASST	67,375

Note that the RECAP value could subsequently be referred to by the name CURASST, which functions as an explicit label.

Using Labels to Repeat Rows

In certain cases, you may wish to repeat an entire row later in your report. For example, the CASH account can appear in the Asset statement and Cash Flow statement of a financial analysis, as shown below.

```
TABLE FILE LEDGER
SUM AMOUNT FOR ACCOUNT
"ASSETS"                OVER
10$$$ AS 'CASH' LABEL TOTCASH  OVER
.
.
"CASH FLOW"            OVER
RECAP SAMECASH/I5C = TOTCASH; AS 'CASH'
END
```

When you refer to the CASH row the second time, you can use a RECAP calculation (with a new name) and refer to the label, either explicitly (TOTCASH) or implicitly (R1), in the row where CASH was first used.

- ✔ **Tip:** If you set the FORMULTIPLE parameter ON, you can repeat the row without giving it another name. For more information, see [Creating Rows From Multiple Records](#).

Referring to Columns in Calculations

An FML report can refer to explicit columns, as well as explicit rows. You can refer to columns using:

- Column numbers.
- Contiguous column notation in RECAP expressions. For example, (2,5) represents columns 2 through 5.
- Column addressing.
- A factor to represent every other column, or every third column, and so on.
- Column notation to control the creation of column reference numbers.
- Column values.

Referring to Column Numbers in Calculations

You can perform a calculation for one column or for a specific set of columns. To identify the columns, place the column number in parentheses after the label name.

Referring to Column Numbers in a RECAP Expression

```
DEFINE FILE LEDGER
CUR_YR/I5C=AMOUNT;
LAST_YR/I5C=.87*CUR_YR - 142;
END
```

```
TABLE FILE LEDGER
```

```

SUM CUR_YR AS 'CURRENT, YEAR'
LAST_YR AS 'LAST, YEAR'
FOR ACCOUNT
1010 AS 'CASH ON HAND'                                OVER
1020 AS 'DEMAND DEPOSITS'                             OVER
1030 AS 'TIME DEPOSITS'                               OVER
BAR                                                    OVER
RECAP TOTCASH/I5C = R1 + R2 + R3; AS 'TOTAL CASH'     OVER
" "                                                    OVER
RECAP GROCASH(2)/F5.2 = 100*TOTCASH(1)/TOTCASH(2) - 100;
AS 'CASH GROWTH(%)'
END

```

In the second RECAP expression, note that:

- TOTCASH(1) refers to total cash in column 1.
- TOTCASH(2) refers to total cash in column 2.
- The resulting calculation is displayed in column 2 of the row labeled CASH GROWTH (%).

The RECAP value is only calculated for the column specified.

The output is shown in the following image.

	CURRENT YEAR	LAST YEAR
	-----	----
CASH ON HAND	8,784	7,214
DEMAND DEPOSITS	4,494	3,482
TIME DEPOSITS	7,961	6,499
	-----	-----
TOTAL CASH	21,239	17,195
CASH GROWTH(%)		23.52

After data retrieval is completed, a single column is calculated all at once, and multiple columns one by one.

Referring to Contiguous Columns in Calculations

When a set of contiguous columns is needed within a RECAP, you can separate the first and last column numbers with commas. For example, DIFFERENCE (2,5) indicates that you want to compute the results for columns 2 through 5.

Recapping Over Contiguous Columns

In this example, the RECAP calculation for ATOT occurs only for columns 2 and 3, as specified in the request. No calculation is performed for column 1.

```

DEFINE FILE LEDGER
CUR_YR/I5C=AMOUNT;
LAST_YR/I5C=.87*CUR_YR - 142;
NEXT_YR/I5C=1.13*CUR_YR + 222;
END

TABLE FILE LEDGER
SUM NEXT_YR CUR_YR LAST_YR
FOR ACCOUNT
10$$ AS 'CASH'                                OVER
1100 AS 'ACCOUNTS RECEIVABLE'                OVER
1200 AS 'INVENTORY'                          OVER
BAR                                           OVER
RECAP ATOT(2,3)/I5C = R1 + R2 + R3;
AS 'ASSETS--ACTUAL'
END

```

The output is shown in the following image.

	<u>NEXT_YR</u>	<u>CUR_YR</u>	<u>LAST_YR</u>
CASH	25,992	21,239	17,198
ACCOUNTS RECEIVABLE	21,941	18,829	15,954
INVENTORY	31,522	27,307	23,329
ASSETS--ACTUAL	-----	67,375	56,481

	<u>NEXT_YR</u>	<u>CUR_YR</u>	<u>LAST_YR</u>
CASH	-----	-----	-----
CASH	25,991	21,239	17,195
ACCOUNTS RECEIVABLE	21,941	18,829	15,954

INVENTORY	31,522	27,307	23,329
	-----	-----	-----
ASSETS--ACTUAL		67,375	56,478

Referring to Column Addresses in Calculations

When you need a calculation for every other or every third column instead of every column, you can supply a factor, or column address, to do this. Column addressing is useful when several data fields are displayed within each value of a column sort.

Use Column Addressing in a RECAP Expression

The left-hand side of the expression has the form:

```
value(s,e,i)[/format]=
```

where:

value

Is the name you assign to the result of the RECAP calculation.

s

Is the starting column.

e

Is the ending column (it may be * to denote all columns).

i

Is the increment factor.

format

Is the USAGE format of the calculated value. The default value is the format of the original column.

Applying Column Addressing in a RECAP Expression

In the following statement, there are two columns for each month:

```
SUM ACTUAL AND FORECAST ACROSS MONTH
```

If you want to perform a calculation only for the ACTUAL data, control the placement of the results with a RECAP in the form:

```
RECAP calcname(1,*,2)=expression;
```

The asterisk means to continue the RECAP for all odd-numbered columns (beginning in column 1, with an increment of 2, for all columns).

Referring to Relative Column Addresses in Calculations

A calculation can use a specific column as a base, and refer to all other columns by their displacement from that column. The column to the left of the base column has a displacement of -1 relative to the base column. The column to the right has a displacement of +1. For example,

```
COMP=FIX(*)-FIX(*-1);
```

can refer to the change in fixed assets from one period to the next. The reference to COMP=FIX(*) is equivalent to COMP=FIX.

When referring to a prior column, the column must already have been retrieved, or its value is zero.

Applying Relative Column Addressing in a RECAP Expression

This example computes the change in cash (CHGCASH) for columns 1 and 2.

```

DEFINE FILE LEDGER
CUR_YR/I5C=AMOUNT;
LAST_YR/I5C=.87*CUR_YR - 142;
NEXT_YR/I5C=1.13*CUR_YR + 222;
END

TABLE FILE LEDGER
SUM NEXT_YR CUR_YR LAST_YR
FOR ACCOUNT
10$$ AS 'TOTAL CASH' LABEL TOTCASH          OVER
" " " " " " OVER
RECAP CHGCASH(1,2)/I5SC = TOTCASH(*) - TOTCASH(*+1); AS 'CHANGE IN CASH'
END

```

The output is shown in the following image.

	NEXT_YR	CUR_YR	LAST_YR
	-----	-----	-----
TOTAL CASH	25,991	21,239	17,195
CHANGE IN CASH	4,752	4,044	

Controlling the Creation of Column Reference Numbers

Column notation assigns a sequential column number to each column in the internal matrix created for a report request. If you want to control the creation of column reference numbers for the columns that are used in your report, use the CNOTATION column notation command.

Because column numbers refer to columns in the internal matrix, they are assigned after retrieval and aggregation of data are completed. Columns created and displayed in a report are stored in the internal matrix, and columns that are not displayed in a report may also be generated and stored in the internal matrix. Columns stored in the internal matrix include calculated values, reformatted field values, BY fields, fields with the NOPRINT option, and certain RECAP calculations such as FORECAST and REGRESS. Every other column in the internal matrix is assigned a column number by default, which means you have to account for all internally generated columns, if you want to refer to the appropriate column value in your request.

You can change the default assignment of column reference numbers by using the SET CNOTATION=PRINTONLY command which assigns column numbers only to columns that display in the report output. You can use column notation in COMPUTE and RECAP commands to refer to these columns in your request.

Control the Creation of Column Reference Numbers

```
SET CNOTATION={ALL|PRINTONLY|EXPLICIT}
```

where:

ALL

Assigns column reference numbers to every column in the internal matrix. ALL is the default value.

PRINTONLY

Assigns column reference numbers only to columns that display in the report output.

EXPLICIT

Assigns column reference numbers to all fields referenced in the request, whether displayed or not.



Note: CNOTATION is not supported in an ON TABLE phrase.

Referring to Column Values in Calculations

When a report is sorted using the ACROSS phrase, all of the retrieved values are aligned under their appropriate columns. Each column has a title consisting of one value of the ACROSS field. The entire column of data can be addressed by this value in a RECAP calculation.

Referring to a Column by Its Value in a RECAP Expression

The following request uses a factor that depends on the value of the ACROSS field (YEAR) to calculate the inventory cost for each year. It then calculates the profit by summing the assets and subtracting the inventory cost for each year.

```
TABLE FILE LEDGER
SUM AMOUNT ACROSS YEAR
FOR ACCOUNT
10$$ AS 'CASH' LABEL CASH OVER
1100 AS 'ACCOUNTS RECEIVABLE' LABEL RECEIVE OVER
BAR OVER
1200 AS 'INVENTORY VALUE' LABEL INVENT OVER
RECAP INVENTORY_FACTOR/F5.2 = IF YEAR LT '1986'
THEN 1.1 ELSE 1.25; AS 'INVENTORY COST FACTOR' OVER
RECAP INVENTORY_COST = INVENTORY_FACTOR * INVENT;
AS 'INVENTORY COST' OVER
BAR OVER
RECAP PROFIT = CASH + RECEIVE - INVENTORY_COST;
END
```

The output is shown in the following image.

	YEAR		
	1985	1986	1987
-----	-----	-----	-----
CASH	5,663	7,001	8,575
ACCOUNTS RECEIVABLE	5,295	6,250	7,284
-----	-----	-----	-----
INVENTORY VALUE	7,754	9,076	10,477
INVENTORY COST FACTOR	1.10	1.25	1.25
INVENTORY COST	8,529	11,345	13,096
-----	-----	-----	-----
PROFIT	2,429	1,906	2,763

	YEAR		
	1985	1986	1987
CASH	5,663	7,001	8,575
ACCOUNTS RECEIVABLE	5,295	6,250	7,284
INVENTORY VALUE	7,754	9,076	10,477
INVENTORY COST FACTOR	1.10	1.25	1.25
INVENTORY COST	8,529	11,345	13,096
PROFIT	2,429	1,906	2,763

Referring to Rows and Columns in Calculations

You can style multiple RECAP commands in a matrix when the RECAP statements are placed after the last ACROSS value.

Styling Multiple RECAP Statements in a Matrix

```
TABLE FILE GGSALES
SUM UNITS
BY PRODUCT
ACROSS REGION
RECAP
TTL1/I8 = C1+C2+C3+C4;
TTL2/D12.2 = TTL1*1.25;
ON TABLE HOLD FORMAT HTML
ON TABLE SET STYLE *
TYPE=DATA, COLUMN=TTL1 (*), COLOR=BLUE, BACKCOLOR=SILVER, STYLE=BOLD, $
TYPE=DATA, COLUMN=TTL2 (*), COLOR=RED, BACKCOLOR=AQUA, STYLE=BOLD, $
ENDSTYLE
END
```

The output is shown in the following image.

Product	Region				TTL1	TTL2
	Midwest	Northeast	Southeast	West		
Biscotti	86105	145242	119594	70436	421377	526,721.25
Capuccino	.	44785	73264	71168	189217	236,521.25
Coffee Grinder	50393	40977	47083	48081	186534	233,167.50
Coffee Pot	47156	46185	49922	47432	190695	238,368.75
Croissant	139182	137394	156456	197022	630054	787,567.50
Espresso	101154	68127	68030	71675	308986	386,232.50
Latte	231623	222866	209654	213920	878063	1,097,578.75
Mug	86718	91497	88474	93881	360570	450,712.50
Scone	116127	70732	73779	72776	333414	416,767.50
Thermos	46587	48870	48976	45648	190081	237,601.25

Referring to Cells in Calculations

You can refer to columns and rows using a form of cell notation that identifies the intersection of a row and a column as (r, c).

Use Cell Notation for Rows and Columns in a RECAP Expression

A row and column can be addressed in an expression by the notation:

$$E(r,c)$$

where:

E

Is a required constant.

r

Is the row number.

c

Is the column number. Use an asterisk (*) to indicate the current column.

Referring to Columns Using Cell Notation in a RECAP Expression

In this request, two RECAP expressions derive VARIANCES (EVAR and WVAR) by subtracting values in four columns (1, 2, 3, 4) in row three (PROFIT). These values are identified using cell notation (r,c).

```
TABLE FILE REGION
SUM E_ACTUAL E_BUDGET W_ACTUAL W_BUDGET
FOR ACCOUNT
3000 AS 'SALES' OVER
3100 AS 'COST' OVER
BAR OVER
RECAP PROFIT/I5C = R1 - R2; OVER
" " OVER
RECAP EVAR(1)/I5C = E(3,1) - E(3,2); OVER
AS 'EAST--VARIANCE' OVER
RECAP WVAR(3)/I5C = E(3,3) - E(3,4);
AS 'WEST--VARIANCE'
END
```

The output is shown as follows.

	E_ACTUAL	E_BUDGET	W_ACTUAL	W_BUDGET
	-----	-----	-----	-----
SALES	6,000	4,934	7,222	7,056
COST	4,650	3,760	5,697	5,410
	-----	-----	-----	-----
PROFIT	1,350	1,174	1,525	1,646
EAST--VARIANCE	176			
WEST--VARIANCE			-121	

i Note: In addition to illustrating cell notation, this example demonstrates the use of column numbering. Notice that the display of the EAST and WEST VARIANCES in columns 1 and 3, respectively, are controlled by the numbers in parentheses in the request: EVAR (1) and WVAR (3).

Using Functions in RECAP Calculations

You may provide your own calculation routines in RECAP rows to perform special-purpose calculations, a useful feature when these calculations are mathematically complex or require extensive look-up tables.

User-written functions are coded as subroutines in any language that supports a call process, such as FORTRAN, COBOL, PL/1, and BAL. For information about creating your own functions, see the *ibi™ WebFOCUS® Using Functions* manual.

Call a Function in a RECAP Command

```
RECAP calcname[(s,e,i)][/format]=function
(input1,...,inputn,'format2');
```

where:

calcname

Is the name you assign to the calculated value.

(s,e,i)

Specify a start (s), end (e), and increment (i) value for the column where you want the value displayed. If omitted, the value appears in all columns.

format

The format for the calculation is optional. The default is the format of the column. If the calculation consists of only the subroutine, make sure that the format of the subroutine output value (*format2*) agrees with the calculation format. If the calculation format is larger than the column width, the value displays in that column as asterisks (*).

function

Is the name of the function, up to eight characters long. It must be different from any row label and cannot contain any of the following special characters:

```
= - , / ( )
```

input1, inputn

Are the input arguments for the call to the function. They may include numeric constants, alphanumeric literals, row and column references notation, E notation, or labels, or names of other RECAP calculations.

Make sure that the values being passed to the function agree in number and type with the arguments as coded in the function.

format2

Is the format of the return value, which must be enclosed in single quotation marks.

Calling a Function in a RECAP Command

Suppose you have a function named INVEST in your private collection of functions (INVEST is not available in the supplied library), and it calculates an amount on the basis of cash on hand, total assets, and the current date. In order to create a report that prints an account of company assets and calculates how much money the company has available to invest, you must create a report request that invokes the INVEST function.

The current date is obtained from the &YMD system variable. The NOPRINT option beside it prevents the date from appearing in the report. The date is solely used as an input for the next RECAP statement.

The request is:

```
TABLE FILE LEDGER
HEADING CENTER
"ASSETS AND MONEY AVAILABLE FOR INVESTMENT </2"
SUM AMOUNT ACROSS HIGHEST YEAR
IF YEAR EQ 1985 OR 1986
FOR ACCOUNT
1010 AS 'CASH' LABEL CASH OVER
1020 AS 'ACCOUNTS RECEIVABLE' LABEL ACR OVER
1030 AS 'INTEREST RECEIVABLE' LABEL ACI OVER
```

```

1100 AS 'FUEL INVENTORY'                LABEL FUEL    OVER
1200 AS 'MATERIALS AND SUPPLIES'        LABEL MAT     OVER
BAR                                       OVER
RECAP TOTCAS = CASH+ACR+ACI+FUEL+MAT; AS 'TOTAL ASSETS' OVER
BAR                                       OVER
RECAP THISDATE/A8 = &YMD; NOPRINT        OVER
RECAP INVAIL = INVEST(CASH,TOTCAS,THISDATE,'D12.2'); AS OVER
      'AVAIL. FOR INVESTMENT'
BAR AS '='
END

```

The output is shown in the following image.

```

ASSETS AND MONEY AVAILABLE FOR INVESTMENT
      YEAR
      1986    1985
-----
CASH                2,100    1,684
ACCOUNTS RECEIVABLE    875     619
INTEREST RECEIVABLE   4,026   3,360
FUEL INVENTORY        6,250   5,295
MATERIALS AND SUPPLIES 9,076   7,754
-----
TOTAL ASSETS         22,327  18,712
-----
AVAIL. FOR INVESTMENT  3,481   2,994
=====

```

ASSETS AND MONEY AVAILABLE FOR INVESTMENT			
	YEAR		
	1986	1985	
CASH	2,100	1,684	
ACCOUNTS RECEIVABLE	875	619	
INTEREST RECEIVABLE	4,026	3,360	
FUEL INVENTORY	6,250	5,295	
MATERIALS AND SUPPLIES	9,076	7,754	
TOTAL ASSETS	<u>22,327</u>	<u>18,712</u>	
AVAIL. FOR INVESTMENT	<u>3,481</u>	<u>2,994</u>	

Inserting Rows of Free Text

Insert text anywhere in your FML report by typing it on a line by itself and enclosing it within double quotation marks. You can also add blank lines, designated as text, to

improve the appearance of the report.

In addition, you can include data developed in your FML report in a row of free text by including the label for the data variable in the text row.

Inserting Free Text

In this example, three rows of free text are inserted, one blank and two text rows.

```
TABLE FILE LEDGER
SUM AMOUNT FOR ACCOUNT
" --- CASH ACCOUNTS ---"           OVER
1010 AS 'CASH ON HAND'             OVER
1020 AS 'DEMAND DEPOSITS'          OVER
1030 AS 'TIME DEPOSITS'            OVER
" "                                  OVER
" --- OTHER CURRENT ASSETS ---"    OVER
1100 AS 'ACCOUNTS RECEIVABLE'      OVER
1200 AS 'INVENTORY'
END
```

The output is shown as follows.

```

                AMOUNT
                -----
    --- CASH ACCOUNTS ---
CASH ON HAND      8,784
DEMAND DEPOSITS  4,494
TIME DEPOSITS    7,961

    --- OTHER CURRENT ASSETS ---
ACCOUNTS RECEIVABLE 18,829
INVENTORY           27,307
```

Notice that the blank row was created by enclosing a blank within double quotation marks on a separate line of the report request.

Insert Data Variables in Text Rows

```
"text <label[(c)] [>]"
```

where:

<

Is a required left caret to bracket the label.

label

Is the explicit or implicit row label. (In a RECAP, the calculated value functions as the label.)

c

Is an optional cell identifier that indicates the column number of the cell. However, this identifier is required whenever there is more than one column in the report. If you use it, enclose it in parentheses.

>

Is an optional right caret that can be used to make the positioning clearer.

Inserting a Data Variable in a Text Row

In this example, the RECAP value CURASST is suppressed by the NOPRINT command, and inserted instead as a data variable in the text row.

```
SET PAGE-NUM=OFF
TABLE FILE LEDGER
SUM AMOUNT FOR ACCOUNT
10$$ AS 'Cash'                LABEL CA    OVER
1100 AS 'Accounts Receivable' LABEL AR    OVER
1200 AS 'Inventory'          LABEL INV   OVER
RECAP CURASST/I5C = CA + AR + INV; NOPRINT OVER
"Current Assets: <CURASST"
END
```

The output is shown in the following image.

```

                AMOUNT
                -----
Cash                21,239
Accounts Receivable 18,829
Inventory           27,307
Current Assets: 67,375
```

Adding a Column to an FML Report

The request controls the number of columns in any report. For instance, if a request contains the display command `SUM AMOUNT AND FORECAST`, the report contains two columns: `AMOUNT` and `FORECAST`.

Add columns in an FML request, just as in a `TABLE` request, using the `COMPUTE` command to calculate a value or simply to allocate the space, column title, and format for a column.

Adding a Column to an FML Report

This example uses a `COMPUTE` command to generate the calculated value `CHANGE` and display it as a new column in the FML report. The following request generates an FML matrix with four rows and three columns of data.

```

DEFINE FILE LEDGER
CUR_YR/I5C=AMOUNT;
LAST_YR/I5C=.87*CUR_YR - 142;
END

TABLE FILE LEDGER
SUM CUR_YR AS 'CURRENT, YEAR'
   LAST_YR AS 'LAST, YEAR'
COMPUTE CHANGE/I5C = CUR_YR - LAST_YR;
FOR ACCOUNT
1010 AS 'CASH ON HAND'           OVER
1020 AS 'DEMAND DEPOSITS'       OVER
1030 AS 'TIME DEPOSITS'         OVER
BAR                               OVER
RECAP TOTCASH/I5C = R1 + R2 + R3; AS 'TOTAL CASH'
END

```

	CURRENT	LAST	
	<u>YEAR</u>	<u>YEAR</u>	<u>CHANGE</u>
CASH ON HAND	8,784	7,216	1,568
DEMAND DEPOSITS	4,494	3,483	1,011
TIME DEPOSITS	7,961	6,499	1,462
TOTAL CASH	21,239	17,198	4,041

```

CURRENT    LAST
YEAR       YEAR  CHANGE

```

CASH ON HAND	8,784	7,214	1,570
DEMAND DEPOSITS	4,494	3,482	1,012
TIME DEPOSITS	7,961	6,499	1,462
TOTAL CASH	21,239	17,195	4,044

Note: The designated calculation is performed on each tag or RECAP row of the report. The RECAP rows, however, may change the calculation.

Adding a New Time Period as a Column

The following request adds a future time period to a report.

```

DEFINE FILE LEDGER
CUR_YR/P5C=AMOUNT;
LAST_YR/P5C=.87*AMOUNT - 142;
END

TABLE FILE LEDGER
SUM AMOUNT
ACROSS YEAR AND COMPUTE 1999/P5C = 2.5*AMOUNT;
FOR ACCOUNT
1010 AS 'CASH ON HAND' OVER
1020 AS 'DEMAND DEPOSITS' OVER
1030 AS 'TIME DEPOSITS' OVER
BAR OVER
RECAP TOTCASH/P5C = R1 + R2 + R3; AS 'TOTAL CASH' OVER
RECAP CHANGE(2,*) = TOTCASH(*) - TOTCASH(*-1);
END

```

The output is shown as follows.

	YEAR			
	1985	1986	1987	1999
CASH ON HAND	1,684	2,100	5,000	4,210
DEMAND DEPOSITS	619	875	3,000	1,548
TIME DEPOSITS	3,360	4,026	575	8,400
TOTAL CASH	5,663	7,001	8,575	14,158
CHANGE		1,338	1,574	5,583

	YEAR			
	1985	1986	1987	1989
CASH ON HAND	1,684	2,100	5,000	4,210
DEMAND DEPOSITS	619	875	3,000	1,548
TIME DEPOSITS	3,360	4,026	575	8,400
TOTAL CASH	5,663	7,001	8,575	14,158
CHANGE		1,338	1,574	5,583

Creating a Recursive Model

Models involving different time periods often require using the ending value of one-time period as the starting value for the next. The calculations describing these situations have two characteristics:

- The labels on one or more RECAP rows are duplicates of other rows. They are used repeatedly to recompute certain values.
- A calculation may refer to a label not yet described, but provided later in the model. If, at the end of the model, a label that is needed is missing, a message is displayed.

Recursive models require that the columns are produced in sequential order, one by one. In nonrecursive models, all of the columns can be produced simultaneously. Schematically, these patterns are shown as follows.

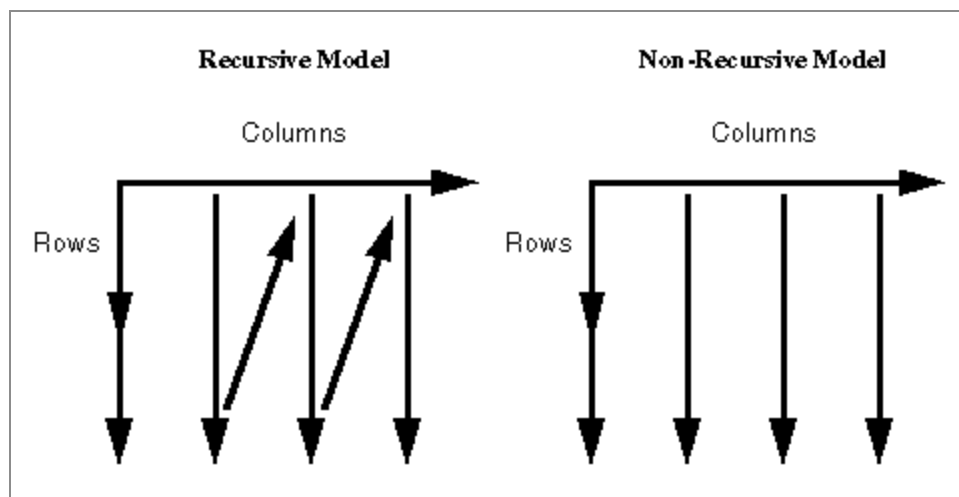

FML automatically switches to sequential order as soon as either of the two modeling conditions requiring the switch is recognized (either reuse of labels by different rows, or forward reference to a label in a calculation).

Creating a Recursive Model

The following example illustrates recursive models. Note that one year of ENDCASH becomes the next year of STARTING CASH.

```

DEFINE FILE REGION
CUR_YR=E_ACTUAL;
LAST_YR=.831*CUR_YR;
NEXT_YR=1.2297*CUR_YR;
END

TABLE FILE REGION
SUM LAST_YR CUR_YR NEXT_YR
FOR ACCOUNT
10$$ AS 'STARTING CASH' LABEL STCASH          OVER
RECAP STCASH(2,*) = ENDCASH(*-1);           OVER
" "                                          OVER
3000 AS 'SALES' LABEL SLS                   OVER
3100 AS 'COST' LABEL COST                   OVER
BAR                                          OVER
RECAP PROFIT/I5C = SLS - COST;              OVER
" "                                          OVER
RECAP ENDCASH/I5C = STCASH + PROFIT;
END

```

The output is shown as follows.

	LAST_YR	CUR_YR	NEXT_YR
	-----	-----	-----
STARTING CASH	7,903.64	9,024.00	10,374.00
SALES	4,986.00	6,000.00	7,378.20
COST	3,864.15	4,650.00	5,718.10
	-----	-----	-----
PROFIT	1,121	1,350	1,660
ENDCASH	9,024	10,374	12,034

	<u>LAST_YR</u>	<u>CUR_YR</u>	<u>NEXT_YR</u>
STARTING CASH	7,903.64	9,024.00	10,374.00
SALES	4,986.00	6,000.00	7,378.20
COST	3,864.15	4,650.00	5,718.11
PROFIT	1,121	1,350	1,660
ENDCASH	9,024	10,374	12,034

Reporting Dynamically From a Hierarchy

Hierarchical relationships between fields can be defined in a Master File, and automatically displayed using the Financial Modeling Language (FML). The parent and child fields must share data values, and their relationship should be hierarchical. The formats of the parent and child fields must both be either numeric or alphanumeric.

For example, suppose that:

- Employee and manager IDs are contained within an employee data source.
- or
- A general ledger data source contains both an account number field and an account parent field.

By examining these fields, it is possible to construct the entire organization chart or chart of accounts structure. However, to print the chart in a traditional FML report, you need to list the employee IDs or account numbers in the request syntax in the order in which they should appear on the report. If an employee or account is added, removed, or transferred, you have to change the report request to reflect this change in organizational structure.

For example:

```
TABLE FILE EMPLOYEE
PRINT DEPARTMENT CURR_JOBCODE
FOR EMP_ID
999999999 OVER
222222222 OVER
.
.
.
```

In contrast, with FML hierarchies you can define the hierarchical relationship between two fields in the Master File and load this information into memory. The FML request can then dynamically construct the rows that represent this relationship and display them in the

report, starting at any point in the hierarchy. In the example shown, EMP_ID is called the hierarchy field.

Requirements for FML Hierarchies

1. In the Master File, use the PROPERTY=PARENT_OF and REFERENCE=hierarchyfld attributes to define the hierarchical relationship between two fields. For more information, see the *ibi™ FOCUS® Describing Data* manual.

The hierarchy must be loaded into memory. This loaded hierarchy is called a chart. If the hierarchy is defined in the Master File and referenced by the FML request, it is loaded automatically. If you want to use a hierarchy defined in a Master File that is not either referenced in the FML request or joined to the Master File referenced in the FML request, issue the LOAD CHART command before issuing the FML request.

The number of charts that can be loaded is 16. Charts are automatically unloaded when the session ends.

2. In the FOR phrase of the FML request. Use the GET/WITH CHILDREN or ADD phrase to retrieve the hierarchical data starting at a specific point in the hierarchy.

To use FML hierarchies, the FOR field must either be:

- The hierarchy field.
- or
- Used as the join field to a unique segment that has the hierarchy field. In this case, the hierarchy field must be the join field. Note that the condition that the join are unique only applies if the hierarchy is defined in the cross-referenced segment.

In other words, the FOR field must be in a parent-child hierarchy, or linked to one. The latter case allows transaction data that contains the hierarchy field to be joined to a separate data source that contains the hierarchy definition.

As with any FML request, a tagged row is displayed even if no data is found in the file for the tag values, with a period (.) representing the missing data. You can override this convention by adding the phrase WHEN EXISTS to the definition of a tagged row. This makes displaying a row dependent upon the existence of data for the tag.



Note: In order for the hierarchical indentations to be retained in HTML output, the setting SHOWBLANKS=ON must be in effect.

Defining a Hierarchy in a Master File

The CENTGL Master File contains a charts of accounts hierarchy. The field GL_ACCOUNT_PARENT is the parent field in the hierarchy. The field GL_ACCOUNT is the hierarchy field. The field GL_ACCOUNT_CAPTION can be used as the descriptive caption for the hierarchy field.

```
FILE=CENTGL      ,SUFFIX=FOC
SEGNAME=ACCOUNTS,SEGTYPE=S01
FIELDNAME=GL_ACCOUNT,      ALIAS=GLACCT,  FORMAT=A7,
      TITLE='Ledger,Account', FIELDTYPE=I, $
FIELDNAME=GL_ACCOUNT_PARENT, ALIAS=GLPAR,  FORMAT=A7,
      TITLE=Parent,
      PROPERTY=PARENT_OF, REFERENCE=GL_ACCOUNT, $
FIELDNAME=GL_ACCOUNT_TYPE,  ALIAS=GLTYPE,  FORMAT=A1,
      TITLE=Type,$
FIELDNAME=GL_ROLLUP_OP,     ALIAS=GLROLL,  FORMAT=A1,
      TITLE=Op, $
FIELDNAME=GL_ACCOUNT_LEVEL, ALIAS=GLLEVEL, FORMAT=I3,
      TITLE=Lev, $
FIELDNAME=GL_ACCOUNT_CAPTION, ALIAS=GLCAP,  FORMAT=A30,
      TITLE=Caption,
      PROPERTY=CAPTION, REFERENCE=GL_ACCOUNT, $
FIELDNAME=SYS_ACCOUNT,     ALIAS=ALINE,  FORMAT=A6,
      TITLE='System,Account,Line', MISSING=ON, $
```

The CENTSYSF data source contains detail-level financial data. This is unconsolidated financial data for a fictional corporation, CenturyCorp. It is designed to be separate from the CENTGL database as if it came from an external accounting system. It uses a different account line system (SYS_ACCOUNT) which can be joined to the SYS_ACCOUNT field in CENTGL. Data uses *natural* signs (expenses are positive, revenue negative).

```
FILE=CENTSYSF    ,SUFFIX=FOC
SEGNAME=RAWDATA  ,SEGTYPE=S2
FIELDNAME=SYS_ACCOUNT,  ,A6      , FIELDTYPE=I,
      TITLE='System,Account,Line', $
FIELDNAME=PERIOD      ,  ,YYM    , FIELDTYPE=I, $
FIELDNAME=NAT_AMOUNT  ,  ,D10.0  , TITLE='Month,Actual', $
FIELDNAME=NAT_BUDGET  ,  ,D10.0  , TITLE='Month,Budget', $
FIELDNAME=NAT_YTDAMT  ,  ,D12.0  , TITLE='YTD,Actual', $
```

Displaying an FML Hierarchy

The GET CHILDREN and WITH CHILDREN commands dynamically retrieve and display hierarchical data on the FML report. GET CHILDREN displays only the children, not the parent value referenced in the command. WITH CHILDREN displays the parent and then the children.

Display an FML Hierarchy

```
TABLE FILE filename{PRINT|SUM} ...
FOR hierarchyfld
parentvalue {GET|WITH} CHILD[REN] [n|ALL]
  [AS CAPTION|'text'] [LABEL label]
.
.
.
END
```

where:

filename

Is the name of the file to be used in the FML request. If the hierarchy for this request cannot be loaded automatically, it must have been loaded previously by issuing the LOAD CHART command.

hierarchyfld

Is the hierarchy field name. If the request references a joined structure, the name must be the field name from the host file. The alias name is not supported.

parentvalue

Is the parent value for which the children are to be retrieved.

GET CHILDREN

Displays the hierarchy starting from the first child of the specified *parentvalue*. It does not include the parent in the display. (This corresponds to the FML syntax CHILD1 OVER CHILD2 OVER ...)

WITH CHILDREN

Displays the hierarchy starting from the specified *parentvalue*. It includes the parent in the display. (This corresponds to the FML syntax *parentvalue* OVER CHILD1 OVER CHILD2 OVER ...).

n|ALL

Is a positive integer from 1 to 99, specifying the number of levels of the hierarchy to display. If a number greater than 99 is specified, a warning message is displayed and *n* is set to 99. The default value is 1. Therefore, if *n* is omitted, only direct children are displayed. GET or WITH CHILDREN 2 displays direct children and grandchildren. GET or WITH CHILDREN 99 displays children to 99 levels. ALL is a synonym for 99. Each child instance is printed over the one that follows. Successive levels of the hierarchy field are indented two spaces from the previous level.

CAPTION

Indicates that the caption values to display should be taken from the field defined as the CAPTION in the Master File.

Note that the AS CAPTION phrase is supported for tagged rows, including those that do not use the GET/WITH CHILDREN or ADD syntax. However, the hierarchy must be defined (by specifying the PARENT_OF attribute) in order to load and display the caption values. If the hierarchy is not defined, the AS CAPTION phrase is ignored.

'text'

Is a text string to use as the row title for the hierarchy field values. The CAPTION field defined in the Master File is not used as the caption on the report output.

label

Is an explicit row label. Each generated row is labeled with the specified label text.



Note: The hierarchy is displayed sorted by the parent field and, within the parent, sorted by the hierarchy field.

For information about the FMLFOR, FMLLIST, FMLCAP, and FMLINFO functions that return the tag values and captions used in an FML request, see the *Describing Data With ibi™ WebFOCUS®* manual.

Displaying an FML Hierarchy

The following request displays two levels of account numbers, starting from account 3000:

```
SET SHOWBLANKS=ON
TABLE FILE CENTGL
PRINT GL_ACCOUNT_PARENT
FOR GL_ACCOUNT
3000 WITH CHILDREN 2
END
```

The output is shown as follows.

	Parent

3000	1000
3100	3000
3110	3100
3120	3100
3130	3100
3140	3100
3200	3000
3300	3200
3400	3200
3500	3200
3600	3200
3700	3200
3800	3200
3900	3200

i Note:

- If the request specifies GET CHILDREN instead of WITH CHILDREN, the line for the parent value (3000) does not display on the report output.
- In order to retain the indentations in HTML output, the SET SHOWBLANKS=ON command must be in effect.

Displaying an FML Hierarchy With Captions

The following request displays two levels of a chart of the accounts hierarchy, starting with account 1000 (the top of the hierarchy), and displays the caption field values instead of the account numbers.

```
TABLE FILE CENTGL
PRINT  GL_ACCOUNT_PARENT
FOR    GL_ACCOUNT
1000 WITH CHILDREN 2 AS CAPTION
END
```

The output is shown as follows.

	Parent -----
Profit Before Tax	
Gross Margin	1000
Sales Revenue	2000
Cost Of Goods Sold	2000
Total Operating Expenses	1000
Selling Expenses	3000
General + Admin Expenses	3000
Total R+D Costs	1000
Salaries	5000
Misc. Equipment	5000

i Note: If the request specifies GET CHILDREN instead of WITH CHILDREN, the line for the parent value (1000, Profit Before Tax) does not display on the report output.

Consolidating an FML Hierarchy

The ADD command consolidates multiple levels of the hierarchy on one line of the FML report output. You can use ADD alone or in conjunction with GET CHILDREN or WITH CHILDREN. Note that ADD is designed to work with requests that use the SUM command. It is also designed to be used with detail-level data, not data that is consolidated.

When used alone, ADD aggregates the parent and children on one line of the report output, summing the numeric data values included on the line. This corresponds to the FML syntax *parentvalue* or CHILD1 OR CHILD2 OR ...

When used in conjunction with GET CHILDREN, ADD displays one line for each child of the specified parent value. Each line is a summation of that child and all of its children. You can specify the number of levels of children to display (which determines the number of

lines generated on the report output) and the depth of summation under each child. By default, only direct children have a line in the report output, and the summary for each child includes all of its children.

When used in conjunction with WITH CHILDREN, ADD first displays a line in the report output that consists of the summation of the parent value and all of its children. Then it displays additional lines identical to those displayed by GET CHILDREN ADD.

In order to use a data record in more than one line of an FML report (for example, to display both detail and summary lines or to consolidate detail data at multiple levels), the following setting is required:

```
SET FORMULTIPLE=ON
```

Create One Summary Row for an FML Hierarchy

```
TABLE FILE filenameSUM ...
FOR hierarchyfld
parentvalue ADD [n|ALL]
  [AS CAPTION|'text'] [LABEL label]
.
.
.
END
```

where:

filename

Is the name of the file to be used in the FML request. If the hierarchy for this request cannot be loaded automatically, it must have been loaded previously by issuing the LOAD CHART command.

hierarchyfld

Is the hierarchy field name. If the request references a joined structure, the name must be the field name from the host file. The alias name is not supported.

parentvalue

Is the parent value that determines the starting point in the hierarchy for the aggregation.

ADD

Displays the parent and n levels of its children on one row, summing the numeric data values displayed on the other row. This corresponds to the FML syntax *parentvalue* or CHILD1 OR CHILD2 OR CHILD3 and more, if applicable.

To display the sum of just the children, you must display the parent row, display the summary row, and use a RECAP to subtract the parent row from the sum. For example:

```
FOR ...
parentvalue                OVER
parentvalue ADD 1          OVER
RECAP CHILDSUM = R2-R1;
```

n|ALL

Is a positive integer from 1 to 99, specifying the number of levels of the hierarchy to aggregate. ALL is the default value. Therefore, if n is omitted, all children are included in the sum. If n is 1, only direct children are included. If n is 2, direct children and grandchildren are included. ADD 99 includes up to 99 levels of children. ALL is a synonym for 99.

CAPTION

Indicates that the caption of the parent value displays for the total row.

Note that the AS CAPTION phrase is supported for tagged rows, including those that do not use the GET CHILDREN or ADD syntax. However, the hierarchy must be defined (by specifying the PARENT_OF attribute) in order to load and display the caption values. If the hierarchy is not defined, the AS CAPTION phrase is ignored.

'text'

Is a text string to use as the row title for the aggregate row. The CAPTION field defined in the Master File is not used as the caption on the report output.

label

Is an explicit row label. Each generated row is labeled with the specified label text.

Displaying One Summary Line for an FML Hierarchy

The CENTSYSF data source contains detail-level financial data. To use the account hierarchy in the CENTGL data source with this financial data, the two data sources are joined. The data in CENTSYSF is stored with natural signs, which means, in financial terms, that revenues and liabilities are stored as negative numbers. The portion of the hierarchy used in this request contains only positive data.

Note that the join is not required to be unique, because the hierarchy is defined in the host segment.

First the WITH CHILDREN command displays the lines of the hierarchy starting with account Selling Expenses (3100). Note that only accounts with no children are populated in this detail-level data source. The ADD command then creates one line that is the sum of account 3100 and all of its children.

```

SET FORMULTIPLE=ON
JOIN SYS_ACCOUNT IN CENTGL TO ALL SYS_ACCOUNT IN CENTSYSF
TABLE FILE CENTGL
SUM NAT_AMOUNT/D10.0 NAT_YTDAMT/D10.0
FOR GL_ACCOUNT
3100 WITH CHILDREN ALL AS CAPTION OVER
BAR                                OVER
3100 ADD AS CAPTION
IF PERIOD EQ '2002/03'
END

```

The output is shown as follows.

	Month Actual -----	YTD Actual -----
Selling Expenses	.	.
Advertising	.	.
TV/Radio	1,049,146.	2,954,342.
Print Media	244,589.	721,448.
Internet Advertising	9,542.	29,578.
Promotional Expenses	53,719.	151,732.
Joint Marketing	97,135.	289,799.
Bonuses/Commissions	100,188.	304,199.

Selling Expenses

1,554,319.

4,451,098.

	Month	YTD
	<u>Actual</u>	<u>Actual</u>
Selling Expenses	.	.
Advertising	.	.
TV/Radio	1,049,146.	2,954,342.
Print Media	244,589.	721,448.
Internet Advertising	9,542.	29,578.
Promotional Expenses	53,719.	151,732.
Joint Marketing	97,135.	289,799.
Bonuses/Commissions	100,188.	304,199.
Selling Expenses	1,554,319.	4,451,098.

Consolidate FML Hierarchy Data to Any Level and Depth

```
TABLE FILE filename
SUM ...
FOR hierarchyfld
parentvalue {GET|WITH} CHILD[REN] [n|ALL] ADD [m|ALL]
  [AS CAPTION 'text'] [LABEL label]
.
.
.
END
```

where:

filename

Is the name of the file used in the FML request. If the hierarchy for this request cannot load automatically, it previously loaded by issuing the LOAD CHART command.

hierarchyfld

Is the hierarchy field name. If the request references a joined structure, the name must be the field name from the host file. The alias name is not supported.

parentvalue

Is the parent value that determines the starting point in the hierarchy for the aggregation.

GET|WITH

GET specifies that the first line generated on the report is the consolidated line for the first child of the parent value. WITH specifies that the first line generated on the report is the consolidated line for the parent value, followed by the consolidated lines for each of its children, to the level specified by n .

n|ALL

Is a positive integer from 1 to 99, specifying the number of levels of children to display. The line of output for each child has the sum of that child and its children to the depth specified for the ADD option. The default value is 1. Therefore, if n is omitted, each direct child has a line on the report. If n is 2, direct children and grandchildren each have a line on the report output. ALL is a synonym for 99.

ADD

Sums the hierarchy to the depth specified by m for each line generated by the GET or WITH CHILDREN command.

m|ALL

Is a positive integer from 1 to 99, specifying the number of levels of children to consolidate on each line of the report output. If a number greater than 99 is specified, a warning message is displayed and m is set to 99. The default value is ALL. Therefore, if m is omitted, the consolidated line sums all children. If m is 2, only direct children and grandchildren are consolidated for each line on the report output. ADD 99 aggregates children to 99 levels. ALL is a synonym for 99.

CAPTION

Indicates that the caption of the parent value displays for the total row.

Note that the AS CAPTION phrase is supported for tagged rows, including those that do not use the GET CHILDREN or ADD syntax. However, the hierarchy must be defined (by

specifying the PARENT_OF attribute) in order to load and display the caption values. If the hierarchy is not defined, the AS CAPTION phrase is ignored.

'text'

Is a text string to use as the row title for the aggregate row. The CAPTION field defined in the Master File is not used as the caption on the report output.

label

Is an explicit row label. Each generated row is labeled with the specified label text.

Consolidating FML Hierarchy Data

In the following request, the first WITH CHILD command displays the detail data for the hierarchy starting with account 3100. The next WITH CHILD command creates a consolidated line for the parent account (3100) and each direct child.

```

SET FORMULTIPLE=ON
JOIN SYS_ACCOUNT IN CENTGL TO ALL SYS_ACCOUNT IN CENTSYSF
TABLE FILE CENTGL
SUM NAT_AMOUNT/D10.0 NAT_YTDAMT/D10.0
FOR GL_ACCOUNT
3100 WITH CHILDREN ALL AS CAPTION      OVER
" "                                     OVER
BAR AS =                                OVER
" "                                     OVER
3100 WITH CHILDREN ADD AS CAPTION
IF PERIOD EQ '2002/03'
END

```

Note that the join is not required to be unique, because the hierarchy is defined in the host segment.

In the following output, the top portion shows the detail-level data. The bottom portion shows the consolidated data. In the consolidated portion of the report:

- There is one line for the parent that is the sum of itself plus all of its children to all levels.
- There is one line for each direct child of account Selling Expenses (3100): Advertising, Promotional Expenses, Joint Marketing, and Bonuses/Commissions.

- The line for Advertising is the sum of itself plus all of its children. If it has multiple levels of children, they are all added into the sum. The other direct children of 3100 do not themselves have children, so the sum on each of those lines consists of only the parent value.

	Month Actual -----	YTD Actual -----
Selling Expenses	.	.
Advertising	.	.
TV/Radio	1,049,146.	2,954,342.
Print Media	244,589.	721,448.
Internet Advertising	9,542.	29,578.
Promotional Expenses	53,719.	151,732.
Joint Marketing	97,135.	289,799.
Bonuses/Commissions	100,188.	304,199.
	=====	=====
Selling Expenses	1,554,319.	4,451,098.
Advertising	1,303,277.	3,705,368.
Promotional Expenses	53,719.	151,732.
Joint Marketing	97,135.	289,799.
Bonuses/Commissions	100,188.	304,199.

	Month <u>Actual</u>	YTD <u>Actual</u>
Selling Expenses	.	.
Advertising	.	.
TV/Radio	1,049,146.	2,954,342.
Print Media	244,589.	721,448.
Internet Advertising	9,542.	29,578.
Promotional Expenses	53,719.	151,732.
Joint Marketing	97,135.	289,799.
Bonuses/Commissions	100,188.	304,199.
	-----	-----
Selling Expenses	1,554,319.	4,451,098.
Advertising	1,303,277.	3,705,368.
Promotional Expenses	53,719.	151,732.
Joint Marketing	97,135.	289,799.
Bonuses/Commissions	100,188.	304,199.

Using GET CHILDREN instead of WITH CHILDREN eliminates the top line from each portion of the output. The remaining lines are the same.

	Month Actual -----	YTD Actual -----
Advertising	.	.
TV/Radio	1,049,146.	2,954,342.
Print Media	244,589.	721,448.
Internet Advertising	9,542.	29,578.
Promotional Expenses	53,719.	151,732.
Joint Marketing	97,135.	289,799.
Bonuses/Commissions	100,188.	304,199.
	=====	=====
Advertising	1,303,277.	3,705,368.
Promotional Expenses	53,719.	151,732.
Joint Marketing	97,135.	289,799.
Bonuses/Commissions	100,188.	304,199.

	Month <u>Actual</u>	YTD <u>Actual</u>
Advertising	.	.
TV/Radio	1,049,146.	2,954,342.
Print Media	244,589.	721,448.
Internet Advertising	9,542.	29,578.
Promotional Expenses	53,719.	151,732.
Joint Marketing	97,135.	289,799.
Bonuses/Commissions	100,188.	304,199.
	-----	-----
Advertising	1,303,277.	3,705,368.
Promotional Expenses	53,719.	151,732.
Joint Marketing	97,135.	289,799.
Bonuses/Commissions	100,188.	304,199.

The following request displays a consolidated line for account 2000 and each of its direct children and grandchildren.

```

SET SHOWBLANKS=ON
SET FORMULTIPLE=ON
JOIN SYS_ACCOUNT IN CENTGL TO ALL SYS_ACCOUNT IN CENTSYSF
TABLE FILE CENTGL
SUM NAT_AMOUNT/D10.0 NAT_YTDAMT/D10.0
    
```

```
FOR GL_ACCOUNT
2000 WITH CHILDREN 2 ADD AS CAPTION
IF PERIOD EQ '2002/03'
END
```

The output is shown as follows.

	Month Actual -----	YTD Actual -----
Gross Margin	-4,513,659.	-13,080,549.
Sales Revenue	-10,398,305.	-30,877,546.
Retail Sales	-8,237,253.	-24,539,197.
Mail Order Sales	-1,138,414.	-3,403,387.
Internet Sales	-1,022,638.	-2,934,962.
Cost Of Goods Sold	5,884,646.	17,796,997.
Variable Material Costs	4,415,560.	13,410,629.
Direct Labor	961,143.	2,920,449.
Fixed Costs	507,943.	1,465,919.

	Month <u>Actual</u>	YTD <u>Actual</u>
Gross Margin	-4,513,659.	-13,080,549.
Sales Revenue	-10,398,305.	-30,877,546.
Retail Sales	-8,237,253.	-24,539,197.
Mail Order Sales	-1,138,414.	-3,403,387.
Internet Sales	-1,022,638.	-2,934,962.
Cost Of Goods Sold	5,884,646.	17,796,997.
Variable Material Costs	4,415,560.	13,410,629.
Direct Labor	961,143.	2,920,449.
Fixed Costs	507,943.	1,465,919.

Loading a Hierarchy Manually

In most cases, a hierarchy loads automatically as a result of the request syntax. However, if you need to use a hierarchy defined in one Master File against a data source that is not joined to the hierarchy file (but that contains the same hierarchy field), you can manually load the hierarchy data using the LOAD CHART command.

The number of charts that can load is limited by available memory. Charts automatically unload when the session ends.

The chart loads by running a TABLE request that produces a list of parent values and their associated children.

```
TABLE FILE chartfile
BY parentfield BY hierarchyfield
[SUM captionfield]
END
```

The resulting chart contains the following information. It may also contain the associated captions, depending on whether the AS CAPTION phrase was used in the request.

parentfield	hierarchyfield
-----	-----
parentvalue1	child1
parentvalue1	child2
parentvalue2	child3
.	
.	
.	

Load a Hierarchy From One Master File for Use With a Separate Master File

You can manually load the hierarchy data, if you need to use a hierarchy defined in one Master File, against a data source that is not joined to the hierarchy file but that contains the same hierarchy field.

Available memory dictates the number of charts that can load. Charts automatically unload when FOCUS terminates.

```
LOAD CHART chartfile[.sega].hierarchyfld
[FOR requestfile[.segb].fieldb]]
```

where:

chartfile

Is the name of the Master File that contains the hierarchy information.

sega

Is the name of the segment that contains the hierarchy field. The segment name is only required if a field in another segment in the structure has the same field name as the hierarchy field.

hierarchyfld

Is the hierarchy field. It is required because a Master File can define multiple hierarchies.

FOR

Loads a hierarchy defined in a Master File that is not used in the FML report request. For example, if Master File B contains the hierarchy information but Master File A is used in the request (without a join between Master Files A and B), issue the following LOAD CHART command prior to the FML request:

```
LOAD CHART B.FLDB FOR A.FLDA  
TABLE FILE A ...
```

requestfile

Is the name of the Master File used in the FML request.

segb

Is the name of the segment that contains the hierarchy field values in the Master File used in the FML request. It is not required if it has the same name as *sega*.

fieldb

Is the field in the Master File specified in the FML request that contains the values of the hierarchy field. It is not required if it has the same name as the hierarchy field.

 Note:

- If you issue the LOAD CHART command multiple times for the same hierarchy, the new hierarchy overlays the previous version in memory.
- If you issue the LOAD CHART command for a data source that is dynamically joined to the hierarchy file, you must issue the JOIN command prior to issuing the LOAD CHART command.

Usage Notes for FML Hierarchies

- PROPERTY and REFERENCE are propagated to HOLD Master Files when HOLDATTR is set to ON.
- The following setting is required in order to use a data record in more than one row of an FML request (for example, both a detail and summary row):

```
SET FORMULTIPLE=ON
```

- When reporting against a rolled-up data source such as ESSBASE, the data values stored for the parent instance are an aggregate of all of its children. Do not use the ADD feature on consolidated data.
- When reporting against a data source with shared members (such as ESSBASE), in which the same data can be defined multiple times with different hierarchy field values, data shared by two different parents is counted twice in an aggregation operation. To avoid this double aggregation, use the FST operator in the SUM command for the shared fields.
- When the report output is in HTML format, the setting SHOWBLANKS=ON must be in effect in order to retain the hierarchical indentations.

Customizing a Row Title

You can customize a row title in an FML report for accurate data identification. Using the AS phrase, you can provide new titles for TAG, DATA, RECAP, and PICKUP rows.

Customize a Row Title in FML

For a TAG row, use the syntax:

```
value AS {'title'|CAPTION}
```

For a DATA or PICKUP row, use the syntax:

```
value AS 'title'
```

For a RECAP row, use the syntax:

```
RECAP calcname[/format]=expression; AS 'title'
```

where:

value

Is the value on which you are reporting, whether retrieved from a data source or external file (represented by a tag), supplied directly by a user in the request, or picked up from a work file.

title

Is the customized row title, enclosed in single quotation marks if it contains embedded blanks.

In a TAG, DATA, or PICKUP row, the default row title is *value*.

In a RECAP row, the default title is *calcname*.

CAPTION

In the Master File of a hierarchical data source, CAPTION identifies a TAG row using a caption field. Note that the hierarchy in the Master File defines the PARENT-OF the FOR field.

calcname

Is the value that is derived by the RECAP calculation.

Changing the Titles of Tag Rows

In the following example, the row titles CASH ON HAND and DEMAND DEPOSITS provide meaningful identifications for the corresponding tags.

```
TABLE FILE LEDGER
SUM AMOUNT FOR ACCOUNT
1010 AS 'CASH ON HAND' OVER
```

```
1020 AS 'DEMAND DEPOSITS'
END
```

Note that single quotation marks are necessary since the row title being assigned has embedded blanks.

The output is shown as follows.

	AMOUNT

CASH ON HAND	8,784
DEMAND DEPOSITS	4,494

If no AS phrase is included, the tag values are displayed in the report.

Customizing a Row Title for a RECAP Value

This request creates the title TOTAL CASH for the RECAP value TOTCASH.

```
TABLE FILE LEDGER
SUM AMOUNT FOR ACCOUNT
1010 AS 'CASH ON HAND'      OVER
1020 AS 'DEMAND DEPOSITS'  OVER
1030 AS 'TIME DEPOSITS'    OVER
RECAP TOTCASH = R1 + R2 + R3; AS 'TOTAL CASH'
END
```

The output is shown as follows.

	AMOUNT

CASH ON HAND	8,784
DEMAND DEPOSITS	4,494
TIME DEPOSITS	7,961
TOTAL CASH	21,239

If no AS phrases are included, the name of the RECAP value (TOTCASH) displays in the report.

Formatting an FML Report

Improve the readability and presentation of your FML report by:

- **Underlining numeric columns.** Reports with columns of numbers frequently need to display underlines before some RECAP calculations. You can specify an underline character, introduced by the word BAR, in place of the tag value.
- **Adding page breaks.** You can request a new page at any point in a report by placing the word PAGE-BREAK in place of the tag value.
- **Indenting text or numbers.** You can indent a tag value, label text, or caption text a specified number of spaces for an FML tag row, hierarchy, or RECAP row. If you apply the indent to rows in an FML hierarchy, the parent line of the hierarchy is indented by the number of spaces specified as the indent.

i Note: For an HTML, PDF, or PostScript report, you can use the BLANKINDENT setting to specify an indentation between levels of an FML hierarchy. See [Indenting Row Titles in an FML Hierarchy](#).

i Note: You can also format an FML report using StyleSheet attributes if you are creating an output format that supports StyleSheets.

Add an Underline Character for Columns

```
BAR [AS 'character'] OVER
```

where:

character

Is either the hyphen character (-) or the equal character (=). Enclose the character in single quotation marks. The default character is the hyphen (-).

Underlining Columns

This example uses the default underscore character (_).

```
TABLE FILE LEDGER
SUM AMOUNT FOR ACCOUNT
```

```

1010 AS 'CASH ON HAND'          OVER
1020 AS 'DEMAND DEPOSITS'      OVER
1030 AS 'TIME DEPOSITS'        OVER
BAR                            OVER
RECAP TOTCASH = R1 + R2 + R3;
END

```

The output is shown as follows.

	AMOUNT

CASH ON HAND	8,784
DEMAND DEPOSITS	4,494
TIME DEPOSITS	7,961

TOTCASH	21,239

Notice that the BAR ... OVER phrase underlines only the column containing the display field.

Specify a Page Break in an FML Report

Include the following syntax in the FML request in place of a tag value.

```
PAGE-BREAK OVER
```

Specifying a Page Break in an FML Report

In this example, a page break is inserted after the first two RECAP commands to highlight each calculation.

```

TABLE FILE LEDGER
SUM AMOUNT FOR ACCOUNT
1010 AS 'CASH ON HAND'          OVER
1020 AS 'DEMAND DEPOSITS'      OVER
1030 AS 'TIME DEPOSITS'        OVER
BAR                            OVER

```

```

RECAP TOTCASH = R1 + R2 + R3; AS 'TOTAL CASH'          OVER
PAGE-BREAK                                          OVER
1100 AS 'ACCOUNTS RECEIVABLE' LABEL RECEIVE          OVER
1200 AS 'INVENTORY' LABEL INVENT                    OVER
BAR                                                    OVER
RECAP TOTASSET = RECEIVE + INVENT; AS 'TOTAL ASSETS' OVER
PAGE-BREAK                                          OVER
RECAP TOTAL = TOTCASH + TOTASSET;
END

```

The output is shown as follows.

```

PAGE      1
          AMOUNT
          -----
CASH ON HAND      8,784
DEMAND DEPOSITS  4,494
TIME DEPOSITS    7,961
          -----
TOTAL CASH      21,239
PAGE      2
          AMOUNT
          -----
ACCOUNTS RECEIVABLE 18,829
INVENTORY           27,307
          -----
TOTAL ASSETS      46,136
PAGE      3
          AMOUNT
          -----
TOTAL             67,375

```

PAGE 1	
	<u>AMOUNT</u>
CASH ON HAND	8,784
DEMAND DEPOSITS	4,494
TIME DEPOSITS	7,961

TOTAL CASH	21,239
PAGE 2	
	<u>AMOUNT</u>
ACCOUNTS RECEIVABLE	18,829
INVENTORY	27,307

TOTAL ASSETS	46,136
PAGE 3	
	<u>AMOUNT</u>
TOTAL	67,375

Format a Row, Column, or Cell in an FML Report

```
TYPE=type, [COLUMN=column] [LABEL={Rn|label}], format_def, $
```

where:

type

Identifies the component you wish to format. Valid values are:

REPORT denotes a row with the specified label.

DATA denotes a row with the specified label, which contains user-supplied data values.

FREETEXT denotes a free text or a blank row with the specified label.

UNDERLINE denotes underlines generated by BAR. Formatting of an underline is supported for PDF and PS, but not for HTML reports.

column

Identifies a specific column. You can identify the column by its name or position in a row.

LABEL

Is the controlling factor in identifying and formatting an FML row.

Note that the label is used to identify a row for calculation or formatting. The label for a TAG or DATA row never appears in the report output. It is used only to identify rows within the FML code. For a RECAP row, the name of the calculated value serves as a label. It appears in the report unless an alternate title is specified.

label is an explicit row label that you can assign to identify a row more clearly.

format_def

Is the formatting definition, such as FONT, SIZE, STYLE, and COLOR. See [Formatting an FML Report](#).



Note: To format a cell, identify the cell as the intersection of a column and a row using COLUMN= ... plus LABEL= ... in the same StyleSheet declaration.

Formatting Rows in an FML Report

The following illustrates how to identify and format an entire FML row, consisting of the row label and the row data. The LABEL attribute in the StyleSheet identifies the three TAG rows, which are styled here as italic.

```
SET PAGE-NUM=OFF
TABLE FILE LEDGER
SUM AMOUNT FOR ACCOUNT
1010 AS 'CASH ON HAND' LABEL COH OVER
1020 AS 'DEMAND DEPOSITS' LABEL DD OVER
1030 AS 'TIME DEPOSITS' LABEL TD OVER
BAR OVER
RECAP TOTCASH = R1 + R2 + R3; AS 'TOTAL CASH'
ON TABLE SET STYLESHEET *
```



```

TYPE = REPORT, GRID = OFF, $
TYPE = REPORT, LABEL = COH, STYLE = ITALIC, $
TYPE = REPORT, LABEL = DD, STYLE = ITALIC, $
TYPE = REPORT, LABEL = TD, STYLE = ITALIC, $
ENDSTYLE
END

```

The output is shown in the following image.

	<u>AMOUNT</u>
<i>CASH ON HAND</i>	<i>8,784</i>
<i>DEMAND DEPOSITS</i>	<i>4,494</i>
<i>TIME DEPOSITS</i>	<i>7,961</i>
TOTAL CASH	21,239

Applying Boldface to a TAG Row in an FML Report

This request applies boldface to the customized row title, CASH, and to the related data in the AMOUNT column. The StyleSheet uses the explicit label CA to identify the component to format.

```

SET PAGE-NUM=OFF
TABLE FILE LEDGER
SUM AMOUNT FOR ACCOUNT
10$$ AS 'CASH' LABEL CA OVER
1100 AS 'ACCOUNTS RECEIVABLE' LABEL AR OVER
1200 AS 'INVENTORY' LABEL INV OVER
RECAP CURASST/I5C = CA + AR + INV;
ON TABLE SET STYLESHEET *
TYPE = REPORT, GRID = OFF, $
TYPE = REPORT, LABEL = CA, STYLE = BOLD, $
ENDSTYLE
END

```

The output is shown in the following image.

	<u>AMOUNT</u>
CASH	21,239
ACCOUNTS RECEIVABLE	18,829
INVENTORY	27,307
CURASST	67,375

Applying Boldface to a Cell in an FML Matrix

This request generates a report in which the data value for AMOUNT is bold in the row titled CASH. However, the row title CASH is not bold. This is accomplished by pinpointing the cell in the StyleSheet declaration. In this case, the column (N2) within the row (CA).

```

SET PAGE-NUM=OFF
TABLE FILE LEDGER
SUM AMOUNT FOR ACCOUNT
10$$ AS 'CASH'                LABEL CA    OVER
1100 AS 'ACCOUNTS RECEIVABLE' LABEL AR    OVER
1200 AS 'INVENTORY'          LABEL INV   OVER
RECAP CURASST/I5C = CA + AR + INV;
ON TABLE SET STYLESHEET *
TYPE = REPORT, GRID = OFF, $
TYPE = REPORT, COLUMN = N2, LABEL = CA, STYLE = BOLD, $
ENDSTYLE
END

```

The output is shown in the following image.

	<u>AMOUNT</u>
CASH	21,239
ACCOUNTS RECEIVABLE	18,829
INVENTORY	27,307
CURASST	67,375

Applying Boldface to a Column in an FML Report

This request identifies the AMOUNT column by name and formats its title and data in bold. The same result is achieved if the column is identified as N2.

```

SET PAGE-NUM=OFF
TABLE FILE LEDGER
SUM AMOUNT FOR ACCOUNT
"---CASH ACCOUNTS---"                OVER
1010 AS 'CASH ON HAND'                OVER
1020 AS 'DEMAND DEPOSITS'            OVER
1030 AS 'TIME DEPOSITS'              OVER
" "                                    OVER
"---OTHER CURRENT ASSETS---"         OVER
1100 AS 'ACCOUNTS RECEIVABLE'        OVER
1200 AS 'INVENTORY'
ON TABLE SET STYLESHEET *
TYPE = REPORT, GRID = OFF, $
TYPE = REPORT, COLUMN = AMOUNT, STYLE = BOLD, $

```

```
ENDSTYLE
END
```

The output is shown in the following image.

	<u>AMOUNT</u>
---CASH ACCOUNTS---	
CASH ON HAND	8,784
DEMAND DEPOSITS	4,494
TIME DEPOSITS	7,961
---OTHER CURRENT ASSETS---	
ACCOUNTS RECEIVABLE	18,829
INVENTORY	27,307

Applying Boldface to a Free Text Row

This request styles the free text as bold. Since in this example the same styling applies to both free text rows, labels are not required to distinguish between them.

```
SET PAGE-NUM=OFF
TABLE FILE LEDGER
SUM AMOUNT FOR ACCOUNT
"---CASH ACCOUNTS---" LABEL CA OVER
1010 AS 'CASH ON HAND' OVER
1020 AS 'DEMAND DEPOSITS' OVER
1030 AS 'TIME DEPOSITS' OVER
" " OVER
"---OTHER CURRENT ASSETS---" LABEL OCA OVER
1100 AS 'ACCOUNTS RECEIVABLE' OVER
1200 AS 'INVENTORY'
ON TABLE SET STYLESHEET *
TYPE = REPORT, GRID = OFF, $
TYPE = FREETEXT, STYLE = BOLD, $
ENDSTYLE
END
```

The output is shown in the following image.

	<u>AMOUNT</u>
---CASH ACCOUNTS---	
CASH ON HAND	8,784
DEMAND DEPOSITS	4,494
TIME DEPOSITS	7,961
---OTHER CURRENT ASSETS---	
ACCOUNTS RECEIVABLE	18,829
INVENTORY	27,307

Formatting Free Text Rows Separately in an FML Report

This request uses the SIZE attribute to distinguish two lines of free text: CASH ACCOUNTS and OTHER CURRENT ASSETS. The labels CA and OCA are used to identify and format each row separately.

```

SET PAGE-NUM=OFF
TABLE FILE LEDGER
SUM AMOUNT FOR ACCOUNT
" --- CASH ACCOUNTS ---" LABEL CA           OVER
1010 AS 'CASH ON HAND'                       OVER
1020 AS 'DEMAND DEPOSITS'                     OVER
1030 AS 'TIME DEPOSITS'                       OVER
" "                                           OVER
" --- OTHER CURRENT ASSETS ---" LABEL OCA    OVER
1100 AS 'ACCOUNTS RECEIVABLE'                 OVER
1200 AS 'INVENTORY'
ON TABLE SET STYLESHEET *
TYPE = REPORT, GRID = OFF, $
TYPE = FREETEXT, LABEL = CA, STYLE = BOLD, SIZE = 12, $
TYPE = FREETEXT, LABEL = OCA, STYLE = BOLD, SIZE = 10, $
ENDSTYLE
END

```

The output is shown in the following image.

	<u>AMOUNT</u>
---CASH ACCOUNTS---	
CASH ON HAND	8,784
DEMAND DEPOSITS	4,494
TIME DEPOSITS	7,961
---OTHER CURRENT ASSETS---	
ACCOUNTS RECEIVABLE	18,829
INVENTORY	27,307

Styling Text and a Variable in a Free Text Row

In this example, the text and variable components of the free text row are styled separately. The text, Current Assets, is italic and the value derived from the RECAP calculation is bold.

```

SET PAGE-NUM=OFF
TABLE FILE LEDGER
SUM AMOUNT AS 'Amount' FOR ACCOUNT
10$$ AS 'Cash' LABEL CA OVER
1100 AS 'Accounts Receivable' LABEL AR OVER
1200 AS 'Inventory' LABEL INV OVER
RECAP CURASST/I5C = CA + AR + INV; NOPRINT OVER
"Current Assets: <CURASST"
ON TABLE SET STYLESHEET *
TYPE = REPORT, GRID=OFF, $
TYPE = FREETEXT, OBJECT = TEXT, ITEM = 1, SIZE = 12, STYLE = ITALIC, $
TYPE = FREETEXT, OBJECT = FIELD, ITEM = 1, STYLE = BOLD, $
ENDSTYLE
END

```

The output is shown in the following image.

	<u>AMOUNT</u>
<i>CASH ON HAND</i>	8,784
<i>DEMAND DEPOSITS</i>	4,494
<i>TIME DEPOSITS</i>	7,961

TOTAL CASH	21,239

Applying Boldface to an FML RECAP Row

This request applies boldface to the row title and calculated value in a RECAP row. Notice that the RECAP label in the StyleSheet is TOTCASH. In a RECAP, the name assigned to the calculated value serves as the explicit label.

```

SET PAGE-NUM=OFF
TABLE FILE LEDGER
SUM AMOUNT FOR ACCOUNT
1010 AS 'CASH ON HAND'      LABEL CASH      OVER
1020 AS 'DEMAND DEPOSITS' LABEL DD          OVER
1030 AS 'TIME DEPOSITS'   LABEL TD          OVER
RECAP TOTCASH = R1 + R2 + R3; AS 'TOTAL CASH'
ON TABLE SET STYLESHEET *
TYPE = REPORT, GRID = OFF, $
TYPE = REPORT, LABEL = TOTCASH, STYLE = BOLD, $
TYPE = REPORT, LABEL = CASH, COLUMN = N1, STYLE = ITALIC, $
TYPE = REPORT, LABEL = DD, COLUMN = N1, STYLE = ITALIC, $
TYPE = REPORT, LABEL = TD, COLUMN = N1, STYLE = ITALIC, $
ENDSTYLE
END

```

The output is shown in the following image.

	<u>AMOUNT</u>
<i>CASH ON HAND</i>	8,784
<i>DEMAND DEPOSITS</i>	4,494
<i>TIME DEPOSITS</i>	7,961
TOTAL CASH	21,239

Add and Format Row and Cell Borders

To request a uniform border around a row or cell, use this syntax:

```

TYPE=REPORT, LABEL=row_label, [COLUMN=column,] BORDER=option,
[BORDER-STYLE=line_style,] [BORDER-COLOR={color|RGB® g b}], $

```

To specify different characteristics for the top, bottom, left, and/or right borders, use this syntax:

```
TYPE=REPORT, LABEL=row_label, [COLUMN=column,] BORDER-position=option,
[BORDER-[position-]STYLE=line_style,]
[BORDER-[position-]COLOR={color|RGB(r g b)},] $
```

To specify different characteristics for the top, bottom, left, and/or right borders, use this syntax:

```
TYPE=REPORT, LABEL=row_label, [COLUMN=column,] BORDER-position=option,
[BORDER-[position-]STYLE=line_style,]
[BORDER-[position-]COLOR={color|RGB(r g b)},] $
```

where:

row_label

Is the row to which the specified border characteristics are applied.

column

Used in conjunction with row label. Designates a cell (at the point of intersection of the row and the column) to which the specified border characteristics are applied.

option

Can be one of the following values:

ON turns borders on for the entire heading or footing. ON generates the same line as MEDIUM.

OFF turns borders off for the entire heading or footing. OFF is the default.

LIGHT specifies a thin line. You can specify a light line for the entire heading or footing, or for one or more border positions.

MEDIUM identifies a medium line (ON sets the line as MEDIUM). You can specify a light line for the entire heading or footing, or for one or more border positions. Note that the medium line setting ensures consistency with lines created with GRID attributes.

HEAVY identifies a thick line. You can specify a heavy line for the entire heading or footing, or for one or more border positions.

width specifies the line width in points (where 72 pts=1 inch). You can specify a line width in points for the entire heading or footing or for one or more border positions. Line width specified in points is displayed differently in HTML and PDF output. For uniform appearance, regardless of display format, use LIGHT, MEDIUM, or HEAVY.

position

Specifies which border line to format. Valid values are TOP, BOTTOM, LEFT, RIGHT.

You can specify a position qualifier for any of the BORDER keywords. This enables you to format line width, line style, and line color individually, for any side of the border.

line_style

Sets the style of the border line. WebFOCUS StyleSheets support all of the standard Cascading Style Sheets line styles. Several 3-dimensional styles are only available in HTML, as noted by asterisks. Valid values are:

```
NONE  
SOLID  
DOTTED  
DASHED  
DOUBLE*  
GROOVE*  
RIDGE*  
INSET*  
OUTSET*
```

color

Is one of the preset color values. The default value is BLACK.

If the display or output device does not support colors, it substitutes shades of gray.

RGB

Specifies the font color using a mixture of red, green, and blue.

(r g b)

Is the desired intensity of red, green, and blue, respectively. The values are on a scale of 0 to 255, where 0 is the least intense and 255 is the most intense. Note that using the three color components in equal intensities results in shades of gray.



Note: For HTML reports, the BORDERS feature requires that cascading style sheets be turned ON. This code is not required for PDF and PS reports.

Emphasizing a Row Using Uniform Border Lines

This example places a dashed border of medium thickness around the RECAP row identified by the label TOTCASH. For HTML reports, the BORDERS feature requires that cascading style sheets be turned ON.

```

SET PAGE-NUM=OFF
TABLE FILE LEDGER
SUM AMOUNT FOR ACCOUNT
1010 AS 'CASH ON HAND'      LABEL CASH      OVER
1020 AS 'DEMAND DEPOSITS'  LABEL DD        OVER
1030 AS 'TIME DEPOSITS'    LABEL TD        OVER
RECAP TOTCASH = R1 + R2 + R3; AS 'TOTAL CASH'
ON TABLE SET ONLINE-FMT HTML
ON TABLE SET HTMLCSS ON
ON TABLE SET STYLESHEET *
TYPE = REPORT, GRID = OFF, $
TYPE = REPORT, LABEL = TOTCASH, BORDER = MEDIUM,
      BORDER-STYLE = DASHED, $
ENDSTYLE
END

```

The output is shown in the following image.

	AMOUNT
CASH ON HAND	8,784
DEMAND DEPOSITS	4,494
TIME DEPOSITS	7,961
TOTAL CASH	21,239

Emphasizing a Row Using Different Top/Bottom and Left/Right Borders

This example places a heavy black border line above and below the RECAP row identified by the label TOTCASH, and a thin silver dotted line to the left and right of each column in the row.

For HTML reports, the BORDERS feature requires that cascading style sheets be turned ON.

```

SET PAGE-NUM=OFF
TABLE FILE LEDGER
SUM AMOUNT FOR ACCOUNT
1010 AS 'CASH ON HAND'      LABEL CASH      OVER
1020 AS 'DEMAND DEPOSITS'  LABEL DD        OVER
1030 AS 'TIME DEPOSITS'    LABEL TD        OVER
RECAP TOTCASH = R1 + R2 + R3; AS 'TOTAL CASH'
ON TABLE SET ONLINE-FMT HTML
ON TABLE SET HTMLCSS ON
ON TABLE SET STYLESHEET *
TYPE = REPORT, GRID = OFF,$
TYPE = REPORT, LABEL = TOTCASH,
BORDER-TOP = HEAVY,
BORDER-BOTTOM = HEAVY,
BORDER-LEFT = LIGHT,
BORDER-RIGHT = LIGHT,
BORDER-TOP-STYLE = SOLID,
BORDER-BOTTOM-STYLE = SOLID,
BORDER-LEFT-STYLE = DOTTED,
BORDER-RIGHT-STYLE = DOTTED,
BORDER-LEFT-COLOR = 'SILVER',
BORDER-RIGHT-COLOR = 'SILVER', $
ENDSTYLE
END

```

The output is shown in the following image.

	<u>AMOUNT</u>
CASH ON HAND	8,784
DEMAND DEPOSITS	4,494
TIME DEPOSITS	7,961
TOTAL CASH	21,239

Adding Uniform Border Lines Around a Cell

This example places a border of medium thickness around the cell in the second column of the row identified by the label TOTCASH. The combined LABEL and COLUMN specifications are identified in the cell. The BORDERS feature requires that cascading style sheets be turned ON.

```

SET PAGE-NUM=OFF
TABLE FILE LEDGER
SUM AMOUNT FOR ACCOUNT
1010 AS 'CASH ON HAND'      LABEL CASH      OVER
1020 AS 'DEMAND DEPOSITS'  LABEL DD        OVER
1030 AS 'TIME DEPOSITS'    LABEL TD        OVER
RECAP TOTCASH = R1 + R2 + R3; AS 'TOTAL CASH'
ON TABLE SET ONLINE-FMT HTML
ON TABLE SET HTMLCSS ON
ON TABLE SET STYLESHEET *
TYPE = REPORT, GRID = OFF,$
TYPE = REPORT, LABEL = TOTCASH, COLUMN = N2, BORDER = MEDIUM, $
ENDSTYLE
END

```

The output is shown in the following image.

	<u>AMOUNT</u>
CASH ON HAND	8,784
DEMAND DEPOSITS	4,494
TIME DEPOSITS	7,961
TOTAL CASH	21,239

Specify an Indent for an FML Label, Tag, or Caption

```

FOR forfield [IN k]
tag [[GET CHILDREN|WITH CHILDREN] n] INDENT m [AS ['text'|CAPTION]]
[OVER]

```

or

```

RECAP fieldname[/format]=expression; INDENT m [AS 'text']

```

where:

forfield

Is a field in the data source whose values are included in the report.

k

Is the starting column for the FOR value in an FML report.

tag

Is a value of *forfield* to be displayed on a row of the FML report.

n

Is the number of levels of an FML hierarchy to display on the FML report.

m

Is a positive integer (zero is not supported) specifying the number of spaces to indent the tag value, label, or caption of an FML row or hierarchy. The indentation starts from column one if there is no IN phrase specified in the FOR command. If there is an IN phrase, indentation starts from the column specified in the IN phrase. The maximum indentation is the same as the maximum length of an AS name.

If you indent an FML hierarchy, the parent line of the hierarchy is indented the number of spaces specified as the indent. The hierarchy levels are indented two spaces from each other. If the GET CHILDREN phrase is used, the first line of the hierarchy is indented an additional two spaces because the hierarchy output begins with the first child rather than the parent. For more information about the use of GET CHILDREN, see [Reporting Dynamically From a Hierarchy](#).

'text'

Is a label to be displayed on a row of the FML report.

CAPTION

Indicates that a caption field has been defined in the Master File.

OVER

Indicates that this row is not the last row to be displayed.

fieldname

Is a name you assign to the value calculated by the RECAP command.

format

Is the USAGE format for RECAP field. It cannot exceed the column width. The default is the format of the column in which the calculated value is displayed.

expression

Is the expression that describes how to calculate the field value for RECAP.

Indenting a Tag Row in an FML Hierarchy

In the following request, the label of the second row for tag value 3000 is indented five spaces. Because the GET CHILDREN phrase is used, the first line of the FML hierarchy, in the third row for tag value 3000, is indented seven spaces (five + two).

```
SET FORMULTIPLE=ON
TABLE FILE CENTGL
PRINT GL_ACCOUNT_PARENT
FOR GL_ACCOUNT
3000 AS 'Not Indented' OVER
3000 INDENT 5 AS 'Indented 5' OVER
3000 GET CHILDREN 2 INDENT 5 AS 'Hierarchy Indented 5'
END
```

The output is shown as follows.

	Parent

Not Indented	3000
Indented 5	3000
Hierarchy Indented 5	3000
Hierarchy Indented 5	3100
Hierarchy Indented 5	3100
Hierarchy Indented 5	3100
Hierarchy Indented 5	3100
Hierarchy Indented 5	3000
Hierarchy Indented 5	3200
Hierarchy Indented 5	3200
Hierarchy Indented 5	3200
Hierarchy Indented 5	3200
Hierarchy Indented 5	3200
Hierarchy Indented 5	3200
Hierarchy Indented 5	3200
Hierarchy Indented 5	3200

Indenting FML RECAP Rows

The following request sums price, cost, and quantity in stock for digital and analog product types. The first RECAP command calculates the total for each column, and indents the label five spaces. The second RECAP command calculates the profit, and indents the label 10 spaces.

```
SET FORMULTIPLE=ON
TABLE FILE CENTINV
SUM PRICE COST QTY_IN_STOCK
FOR PRODTYPE
Digital                                OVER
Analog                                OVER
BAR                                    OVER
RECAP TOTAL = R1 + R2; INDENT 5  AS 'Total:'  OVER
BAR                                    OVER
RECAP PROFIT(2) = TOTAL(1) - TOTAL(2); AS 'Profit:' INDENT 10
END
```

The output is shown as follows.

	Price:	Our Cost:	Quantity In Stock:
	-----	-----	-----
Digital	4,080.00	3,052.00	119143
Analog	1,883.00	1,371.00	139345
	-----	-----	-----
Total:	5,963.00	4,423.00	258488
	-----	-----	-----
Profit:		1,540.00	

Indenting Row Titles in an FML Hierarchy

To clarify relationships within an FML hierarchy, the captions (titles) of values are indented at each level. Use the BLANKINDENT parameter in an HTML, PDF, or PostScript report to specify the indentation between each level in the hierarchy. You can use the default indentation for each hierarchy level or choose your own indentation value. To print indented captions in an HTML report, you must set the BLANKINDENT parameter to ON or to a number.

SET BLANKINDENT does not redefine the width of the indented column, if it is not wide enough to accommodate the indented fields. Columns in table-based formats will

automatically size themselves as needed, while columns in position-based formats, such as PDF, PostScript, or PPTX, shift out of alignment. You can use StyleSheet syntax to make the column wide enough for the indented values, and move the columns that follow it. Change the width of a column using the StyleSheet SQUEEZE = n attribute to supply the required space.

A related feature enables you to change the number of blank spaces before the parent line of a hierarchy or before any FML tag or RECAP row in any FML request. For more information, see [Formatting an FML Report](#).

Indent FML Hierarchy Captions in an HTML Report

```
SET BLANKINDENT={ON|OFF|n}  
ON TABLE SET BLANKINDENT {ON|OFF|n}
```

where:

ON

Indents FML hierarchy captions 0.125 units for each space that normally displays before the caption. For child levels in an FML hierarchy, it indents 0.125 units for each space that normally displays between this line and the line above it.

OFF

Turns off indentations for FML hierarchy captions in an HTML report. OFF is the default value. For other formats, uses the default indentation of two spaces.

n

Is an explicit measurement in the unit of measurement defined by the UNITS parameter. This measurement is multiplied by the number of spaces that normally displays before the caption. For child levels in an FML hierarchy, it indents n units for each space that normally displays between this line and the line above it. The default number of spaces is two. Zero (0) produces the same report output as OFF. Negative values for n are not supported.

Using the Default Indentation for FML Hierarchy Captions

The following request creates an HTML report with the default indentation:

```

SET PAGE-NUM=NOPAGE
SET BLANKINDENT=ON
SET FORMULTIPLE=ON
TABLE FILE CENTGL
PRINT GL_ACCOUNT_PARENT
FOR GL_ACCOUNT
3000          AS CAPTION          OVER
3000 GET CHILDREN 2 AS CAPTION
ON TABLE HOLD FORMAT HTML
ON TABLE SET HTMLCSS ON
ON TABLE SET STYLE *
TYPE = REPORT, GRID = OFF, $
ENDSTYLE
END

```

The output is shown in the following image.

	<u>Parent</u>
Total Operating Expenses	1000
Selling Expenses	3000
Advertising	3100
Promotional Expenses	3100
Joint Marketing	3100
Bonuses/Commisions	3100
General + Admin Expenses	3000
Salaries-Corporate	3200
Company Benefits	3200
Depreciation Expenses	3200
Gain/(Loss) Sale of Equipment	3200
Leasehold Expenses	3200
Interest Expenses	3200
Utilities	3200

Specifying an Indentation Value for FML Hierarchy Captions

The following request specifies an indentation of .25 for each level of an FML hierarchy. This number is expressed in the default unit of measurement, which is inches:

```

SET PAGE-NUM=NOPAGE
SET BLANKINDENT=.25
SET FORMMULTIPLE=ON
TABLE FILE CENTGL
PRINT GL_ACCOUNT_PARENT
FOR GL_ACCOUNT
3000          AS CAPTION          OVER
3000 GET  CHILDREN 2 AS CAPTION
ON TABLE HOLD FORMAT HTML
ON TABLE SET STYLE *
TYPE = REPORT, GRID = OFF, $
ENDSTYLE
END

```

The output is shown in the following image.

	<u>Parent</u>
Total Operating Expenses	1000
Selling Expenses	3000
Advertising	3100
Promotional Expenses	3100
Joint Marketing	3100
Bonuses/Commisions	3100
General + Admin Expenses	3000
Salaries-Corporate	3200
Company Benefits	3200
Depreciation Expenses	3200
Gain/(Loss) Sale of Equipment	3200
Leasehold Expenses	3200
Interest Expenses	3200
Utilities	3200

Suppressing the Display of Rows

You may sometimes wish to retrieve data in a TAG row solely for use in a calculation, without displaying the row in a report. To suppress the display of a tag row, add the word NOPRINT to the row declaration, as in a TABLE request.

You may also wish to suppress the display of a TAG row if no data is found for the values. For more information, see [Suppressing Rows With No Data](#).

In addition, you can suppress the display of RECAP rows by adding the word NOPRINT to the RECAP command, following the semicolon. This technique is useful to suppress the display of an intermediate RECAP value, which is intended for use as input to other calculations.

Suppressing the Display of a TAG Row

This example uses the value of COST in its computation, but does not display COST as a row in the report.

```

DEFINE FILE REGION
AMOUNT/I5C=E_ACTUAL;
END

TABLE FILE REGION
SUM AMOUNT FOR ACCOUNT
3000 AS 'SALES' LABEL SLS           OVER
3100 AS 'COST' LABEL COST NOPRINT OVER
RECAP PROFIT/I5C = SLS - COST;     OVER
" "                                OVER
RECAP ROS/F6.2 = 100*PROFIT/SLS;
AS 'RETURN ON SALES'
END

```

The output is shown in the following image.

	AMOUNT

SALES	6,000
PROFIT	1,350
RETURN ON SALES	22.50

	<u>AMOUNT</u>
SALES	6,000
PROFIT	1,350
RETURN ON SALES	22.50

Suppressing Rows With No Data

The text for a tag row is displayed even if no data is found in the file for the tag values, with a period (.) representing the missing data. You can override this convention by adding the phrase WHEN EXISTS to the definition of a TAG row. This makes displaying a row dependent upon the existence of data for the tag. This feature is useful, for example, when the same model is applied to different divisions in a company.

Suppressing Rows With No Data

The CENTSYSF data source has detail-level financial data. Accounts with no children are populated, but those with children are not. The following request suppresses the display of accounts that are not populated:

```
SET FORMULTIPLE=ON
JOIN SYS_ACCOUNT IN CENTGL TO ALL SYS_ACCOUNT IN CENTSYSF
TABLE FILE CENTGL
SUM NAT_AMOUNT/D10.0 NAT_YTDAMT/D10.0
FOR GL_ACCOUNT
3100 WITH CHILDREN ALL AS CAPTION WHEN EXISTS
IF PERIOD EQ '2002/03'
END
```

The output is shown in the following example.

	Month Actual -----	YTD Actual -----
TV/Radio	1,049,146.	2,954,342.
Print Media	244,589.	721,448.
Internet Advertising	9,542.	29,578.
Promotional Expenses	53,719.	151,732.

Joint Marketing	97,135.	289,799.
Bonuses/Commissions	100,188.	304,199.

Saving and Retrieving Intermediate Report Results

Many reports require results developed in prior reports. This can be accomplished only if a place is provided for storing intermediate values. An example is the need to compute net profit in an Income Statement prior to calculating equity in a Balance Sheet. FML can save selected rows from one or more models by posting them to a work file. The posted rows can then be picked up from the work file and reused.

The default work file is FOCPOST. This is a comma-delimited file from which you can report directly if a FOCPOST Master File is available. In order to use the work file in a request, you must assign a physical name to the FOCPOST ddname before running the report that posts the data, and again before running the report that picks up the data.

You can assign the physical name to the file by issuing a FILEDEF command on Windows and UNIX, or a TSO ALLOCATE or DYNAM ALLOCATE command on z/OS, before the request is run. You may create a FILEDEF command by using the Allocation Wizard.

While you cannot prepare an FML report entirely from data that you supply directly in your request, you can prepare a report entirely from data that is stored in a comma-delimited work file.

Posting Data

You can save any TAG, RECAP, or DATA row by posting the output to a file. You can use these rows as though they were provided in a DATA row.

The row is processed in the usual manner in the report, depending on its other options, and then posted. The label of the row is written first, followed by the numeric values of the columns, each comma-separated, and ending with the terminator character (\$). For more information, see [Posting Rows to a Work File](#).

i Note: Only fields that are actually displayed on the report output are posted. Fields that are not printed (for example, fields specified with the NOPRINT option, extra fields that are created when you reformat fields in the request, or fields implied by use in a calculation) are not posted.

Post Data to a File

The syntax for saving any TAG, RECAP, or DATA row is:

```
POST [TO ddname]
```

where:

ddname

Is the logical name you assign to the work file in which you are posting data.

Add this syntax to any row you wish to post to the work file.

Posting Rows to a Work File

The following request creates an FML report, and posts two tag rows to the LEDGEOUT work file.

```
DEFINE FILE LEDGER
CUR_YR/I5C=AMOUNT;
LAST_YR/I5C=.87*CUR_YR - 142;
END
```

```
TABLE FILE LEDGER
SUM CUR_YR LAST_YR
FOR ACCOUNT
1100 LABEL AR POST TO LEDGEOUT OVER
1200 LABEL INV POST TO LEDGEOUT
END
```

The output is shown in the following image.

	CUR_YR	LAST_YR
	-----	-----
1100	18,829	15,954
1200	27,307	23,329

	<u>CUR_YR</u>	<u>LAST_YR</u>
1100	18,829	15,954
1200	27,307	23,329

Pick Up Data From a Work File

You can retrieve posted rows from any work file and use them as if they were provided in a DATA row by adding the following phrase to an FML request.

```
DATA PICKUP [FROM ddname] id1 [OR id2 ...] [LABEL label] [AS 'text']
```

where:

ddname

Is the logical name of the work file from which you are retrieving data.

id

Is the label that was assigned in the work file to the posted row of data that is now being picked up.

label

Is the label you wish to assign to the data you are picking up.

The label you assign to the picked data can, but is not required to, match the label (id) of the posted data.

You can include LABEL and AS phrases, but WHEN EXISTS is not supported.

i Note: The retrieved fields are mapped to all fields (printed or not) in the memory repository (internal matrix) of the report. If the matrix contains columns that do not correspond to the fields in the posted file, the retrieved values may be misaligned. For example, if you reformat a field in the PICKUP request, that field will be represented by two columns in the internal matrix. However, the posted file will have only one value representing that field, and the retrieved values will not be mapped properly to the associated columns in the matrix.

Picking Up Data From a Work File

In the following example, the data in the LEDGER data source and in the LEDGEOUT work file are used in the RECAP calculation. To see how this file was created, refer to [Posting Rows to a Work File](#).

✓ Tip: You must assign a logical name to the file by issuing a FILEDEF command on Windows and UNIX, or a DYNAM ALLOCATE command on z/OS, before the request is run. You may create a FILEDEF command by using the Allocation Wizard.

```
DEFINE FILE LEDGER
CUR_YR/I5C=AMOUNT;
LAST_YR/I5C=.87*CUR_YR - 142;
END
```

```
TABLE FILE LEDGER
SUM CUR_YR LAST_YR
FOR ACCOUNT
1010 TO 1030 AS 'CASH' LABEL CASH OVER
DATA PICKUP FROM LEDGEOUT AR AS 'ACCOUNTS RECEIVABLE' LABEL AR OVER
DATA PICKUP FROM LEDGEOUT INV AS 'INVENTORY' LABEL INV OVER
BAR OVER
RECAP CUR_ASSET/I5C = CASH + AR + INV;
END
```

The output is shown in the following image.

	<u>CUR_YR</u>	<u>LAST_YR</u>
CASH	21,239	17,198
ACCOUNTS RECEIVABLE	18,829	15,954
INVENTORY	27,307	23,329
CUR_ASSET	<u>67,375</u>	<u>56,481</u>

	CUR_YR	LAST_YR
	-----	-----
CASH	21,239	17,195
ACCOUNTS RECEIVABLE	18,829	15,954
INVENTORY	27,307	23,329
	-----	-----
CUR_ASSET	67,375	56,478

The following line can be used to pick up the sum of the two accounts from LEDGEOUT.

```
DATA PICKUP FROM LEDGEOUT AR OR INV
AS 'ACCTS REC AND INVENTORY'
```

i Note: Since the rows in a PICKUP file are stored in standard comma-delimited format, they can be provided either from a prior posting, or directly by a user.

Creating HOLD Files From FML Reports

A report created with FML can be extracted to a HOLD file in the same way as all other reports created with the TABLE language.

In this case, you identify the set of tag values specified for each row by the description field (the AS text supplied in the model). When no text is given for a row, the first tag value is used automatically. Therefore, in simple models with only one tag per row and no text, the lines in the HOLD file contain the single tag value. The rows derived from the RECAP calculation form part of the HOLD file. Pure text rows (including BAR rows) are omitted.

For HOLD to be supported with RECAP, the format of the RECAP field must be the same as the format of the original column.

This feature enables you to create new rows in the HOLD file that are the result of calculations. The augmented HOLD file may then be used in a variety of TABLE requests.

i Note: You cannot reformat RECAP rows when creating HOLD files.

Creating a Hold File From an FML Report

The following request creates a HOLD file that contains records for CASH, ACCOUNTS RECEIVABLE, INVENTORY, and the RECAP row CURRENT ASSETS.

```
TABLE FILE LEDGER
SUM AMOUNT FOR ACCOUNT
1010 TO 1030 AS 'CASH'                                OVER
1100 AS 'ACCOUNTS RECEIVABLE'                        OVER
1200 AS 'INVENTORY'                                  OVER
RECAP CA = R1 + R2 + R3; AS 'CURRENT ASSETS'
ON TABLE HOLD
END
```

Query the HOLD file:

```
>
? HOLD

DEFINITION OF HOLD FILE: HOLD

FIELDNAME          ALIAS          FORMAT

AMOUNT              E01             A 19
                    E02             I5C
```

The report from the HOLD file as:

```
TABLE FILE HOLD
PRINT E01 E02
END
```

The output is shown in the following image.

```

                    AMOUNT
                    -----
CASH                 21,239
ACCOUNTS RECEIVABLE 18,829
```

INVENTORY	27,307
CURRENT ASSETS	67,375

Creating a Free-Form Report

You can present data in an unrestricted or free-form format using a layout of your own design.

Whereas tabular and matrix reports present data in columns and rows for the purpose of comparison across records, and graphic reports present data visually using charts and graphs, free-form reports reflect your chosen positioning of data on a page. Free-form reporting meets your needs when your goal is to present a customized picture of a data source recorded on each page of a report.

i Note: You can create free-form reports with PDF, HTML, and styled formats. HTML output has all report pages on one HTML page. Page breaks are retained in PDF output.

Creating a Free-Form Report

You can create a free-form report from a TABLE request that omits the display commands that control columnar and matrix formatting (PRINT, LIST, SUM, and COUNT). Instead, the request includes the following report features:

Heading	Contains the body of the report. It displays the text characters, graphic characters, and data fields that make up the report.
Footing	Contains the footing of the report. This is the text that appears at the bottom of each page of the report. The footing may display the same characters and data fields as the heading.

Prefix operators	Indicates field calculations and manipulation.
Temporary fields	Derives new values from existing fields in a data source.
BY phrases	Specifies the report sort order, and determines how many records are included on each page.
WHERE criteria	Selects records for the report.

When creating a free-form report, you can:

- Design your report to include text, data fields, and graphic characters. See [Designing a Free-Form Report](#).
- Customize the layout of your report. See [Laying Out a Free-Form Report](#).
- Select the sort order and the records that are included in your report. See [Sorting and Selecting Records in a Free-Form Report](#).

Creating a Free-Form Report

Suppose that you are a Personnel Manager and it is your responsibility to administer your company education policies. This education policy states that the number of hours of outside education that an employee may take at the company expense is determined by the number of hours of in-house education completed by the employee.

To do your job efficiently, you want a report that shows the in-house education history of each employee. Each employee information should display on a separate page so that it can be placed in the employee personnel file and referenced when an employee requests approval to take outside courses.

To meet this requirement, you create the EMPLOYEE EDUCATION HOURS REPORT, which displays a separate page for each employee. Notice that pages 1 and 2 of the report provide information about employees in the MIS department, while page 6 provides information for an employee in the Production department.

The following diagram simulates the output you would see if you ran the procedure in the example named [Request for EMPLOYEE EDUCATION HOURS REPORT](#).

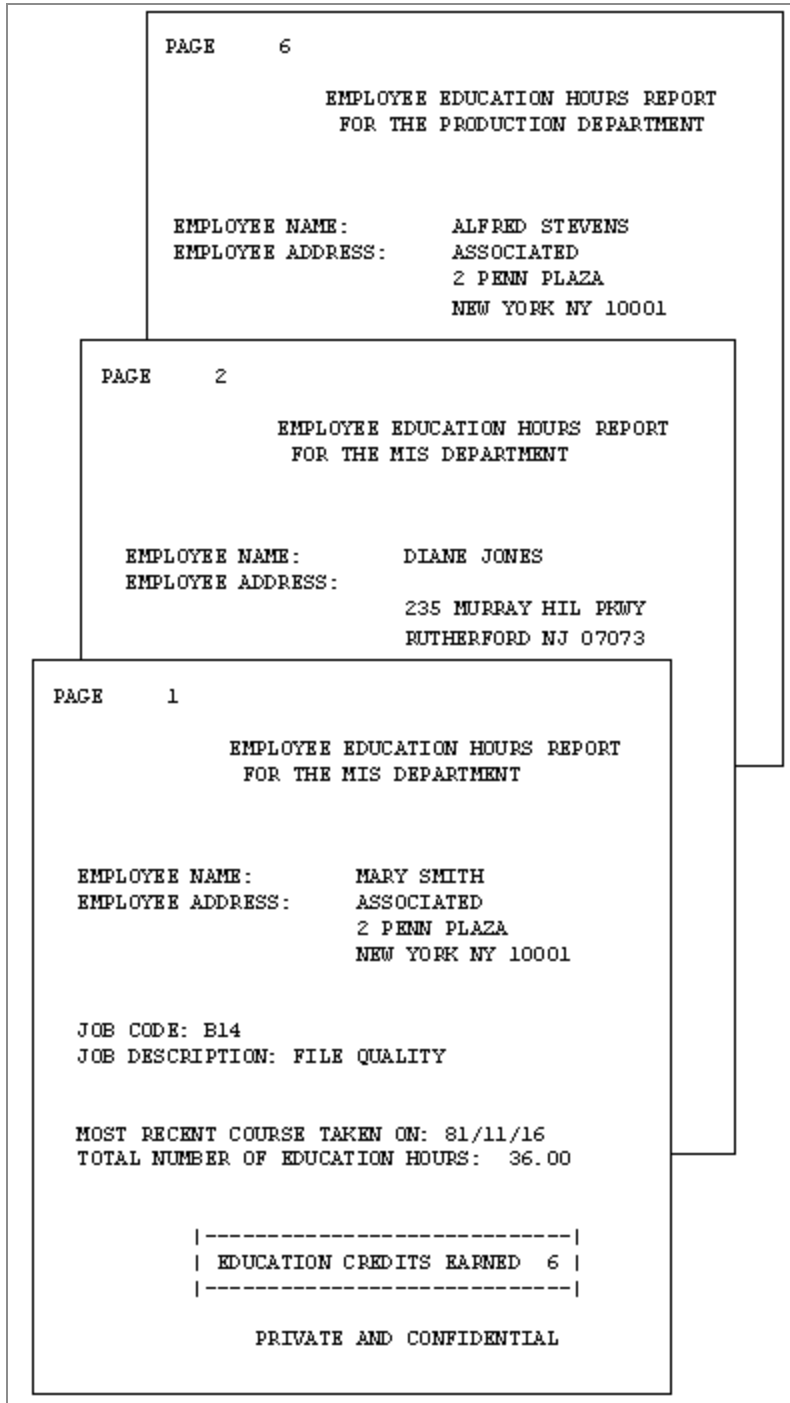

Request for EMPLOYEE EDUCATION HOURS REPORT

The following request produces the EMPLOYEE EDUCATION HOURS REPORT, which you can see in [Creating a Free-Form Report](#). Numbers to the left of the request correspond to numbers in the following annotations:

```

1. DEFINE FILE EMPLOYEE
    CR_EARNED/I2 = IF ED_HRS GE 50 THEN 9
                  ELSE IF ED_HRS GE 30 THEN 6
                  ELSE 3;
    END
2. TABLE FILE EMPLOYEE
3. HEADING
    "PAGE <TABPAGENO"
    " "
    "<13>EMPLOYEE EDUCATION HOURS REPORT"
4. "<14>FOR THE <DEPARTMENT DEPARTMENT"
5. "</2"
    "EMPLOYEE NAME:      <FIRST_NAME> <LAST_NAME>"
    "EMPLOYEE ADDRESS:   <ADDRESS_LN1>"
    "<23><ADDRESS_LN2>"
    "<23><ADDRESS_LN3>"
    "</1"
    "JOB CODE: <JOBCODE>"
    "JOB DESCRIPTION: <JOB_DESC>"
    "</1"
6. "MOST RECENT COURSE TAKEN ON: <MAX.DATE_ATTEND>"
    "TOTAL NUMBER OF EDUCATION HOURS: <ED_HRS>"
    "</1"
7. "<10>|-----|"
8. "<10>| EDUCATION CREDITS EARNED <CR_EARNED>|"
    "<10>|-----|"
9. FOOTING
    "<15>PRIVATE AND CONFIDENTIAL"
    BY DEPARTMENT NOPRINT
10. BY EMP_ID NOPRINT PAGE-BREAK
11. WHERE ED_HRS GT 0
    END

```

The list that follows explains the role of each line of the request in producing the sample report:

1. The DEFINE command creates a virtual field for the report. The calculation reflects the company's policy for earning outside education credits. The result is stored in CR_EARNED and appears later in the report.
2. A free-form report begins with a standard TABLE FILE command. The sample report uses the EMPLOYEE data source for its data.
3. The heading section, initiated by the HEADING command, defines the body of the report. Most of the text and data fields that appear in the report are specified in the heading section. In this request, the heading section continues until the FOOTING command is encountered.
4. This line illustrates the versatility of a heading. It shows the following:
 - The second line of the text in the report heading.
 - A data field embedded in the text: <DEPARTMENT.
 - The start position of the line, column 14: <14>.
5. Line-skipping commands enhance the readability of a report. The command </2, when coded on a line by itself, generates three blank lines, as seen between the report heading and the employee name.
6. This line illustrates how to perform a field calculation in a free-form report using a prefix operator. The request here is for the date on which the most recent course was taken, which is the maximum value for the DATE_ATTEND field.
7. The next three lines illustrate the use of special characters to create a graphic in the report. The box around EDUCATION CREDITS EARNED may need adjustment for output displayed in a proportional font.
8. The value of the field created by the DEFINE command displays in the box, highlighting the number of education credits an employee has earned. This line demonstrates that you can display a virtual field in the body of your report. This is the field that was created at the start of the request.
9. The FOOTING command signifies the beginning of the footing section, ending the heading section as well. Since this is a personnel report, the words PRIVATE AND CONFIDENTIAL must appear at the end of each page of the report. The footing can accomplish this.
10. This line illustrates sorting in a free-form report. The report specifications require that information for only one employee appears per page; that requirement is met through the BY and PAGE-BREAK commands.

11. You can specify record selection in a free-form report. As a result of the WHERE criterion, the report includes only employees who have accumulated in-house education credits.

Designing a Free-Form Report

To design the body of a free-form report, use the HEADING and FOOTING commands. They enable you to:

- Incorporate text, data fields, and graphic characters in your report.
- Lay out your report by positioning text and data in exact column locations and skipping lines for readability.

Use the HEADING command to define the body of a free-form report, and the FOOTING command to define what appears at the bottom of each page of a report. A footing is optional. You can define an entire report using just a heading.

Incorporating Text in a Free-Form Report

You can specify text anywhere in a free-form report, for a variety of purposes. In the sample request (see the example named [Request for EMPLOYEE EDUCATION HOURS REPORT](#)) the text is used:

- As a report title:

```
"<13>EMPLOYEE EDUCATION HOURS REPORT"
```

- As a label for data fields:

```
"EMPLOYEE NAME: <FIRST_NAME <LAST_NAME>"
```

- With a data field and graphic characters:

```
"<10>| EDUCATION CREDITS EARNED <CR_EARNED>|"
```

- As a page footing:

```
"<15>PRIVATE AND CONFIDENTIAL"
```

Incorporating Data Fields in a Free-Form Report

The crucial element in any report, free-form or otherwise, is the data. The data fields available in a request include data fields in the Master File, cross-referenced fields, and virtual fields created with the DEFINE command.

The sample request (see [Request for EMPLOYEE EDUCATION HOURS REPORT](#)) references all three types of data fields:

- ED_HRS is found in the EMPLOYEE Master File:

```
"TOTAL NUMBER OF EDUCATION HOURS: <ED_HRS>"
```

- DATE_ATTEND is found in the EDUCFILE Master File, which is cross-referenced in the EMPLOYEE Master File:

```
"MOST RECENT COURSE TAKEN ON: <MAX.DATE_ATTEND>"
```

- CR_EARNED is created with the DEFINE command before the TABLE FILE command, and is referenced as follows:

```
"<10>| EDUCATION CREDITS EARNED <CR_EARNED>|"
```

You can also apply a prefix operator to a data field to select a particular value (for example, the maximum value within a sort group) or to perform a calculation (for example, to compute the average value of a field). You can use any available prefix operator in a free-form report.

In the sample request, the MAX prefix operator selects the most recent completion date of an in-house course:

```
"MOST RECENT COURSE TAKEN ON: <MAX.DATE_ATTEND>"
```

As is true with all types of reports, you must understand the structure of the data source to use the prefix operators correctly.

Incorporating Graphic Characters in a Free-Form Report

Graphics in a report can be as creative as your imagination. The sample report (see [Creating a Free-Form Report](#)) uses special characters to enclose text and a virtual field in a box. Some other ideas include:

- Highlighting key data fields using asterisks or other special characters available directly from your keyboard, or using the HEXBYT function. See the *ibi™ WebFOCUS® Using Functions* manual for details on HEXBYT.
- Enclosing the entire report in a box to give it a form-like appearance.
- Using double lines to separate the body of the report from its page heading and page footing.

The use of special characters to create graphics is limited by what can be entered and viewed from your workstation and what can be printed on your printer. If you have difficulty producing the graphics that you want, be sure to check with someone in your organization who knows what is available.

Laying Out a Free-Form Report

To provide spacing in a report and position text and data fields, use the spot marker feature of the HEADING and FOOTING commands.

i **Note:** To take advantage of this feature in an HTML report, include the SET STYLEMODE=FIXED command in your request.

The sample request (see the example named [Request for EMPLOYEE EDUCATION HOURS REPORT](#)) illustrates this feature. The first two examples show how to position text and data fields on your report, while the third example shows how to skip lines:

- The spot marker <13> positions the specified text in column 13 of the report:

```
"<13>EMPLOYEE EDUCATION HOURS REPORT"
```

- The spot marker <23> positions the specified data field in column 23 of the report:

```
"<23><ADDRESS_LN2>"
```

- The spot marker </1 on a line by itself skips two lines after displaying the job description:

```
"JOB DESCRIPTION: <JOB_DESC>""</1""MOST RECENT COURSE TAKEN ON:
<MAX.DATE_ATTEND>"
```

When designing a free-form report, take advantage of sort field options, such as NOPRINT, PAGE-BREAK (PDF output only), and UNDER-LINE. The sample request uses PAGE-BREAK to place each employee information on a separate page:

```
BY EMP_ID NOPRINT PAGE-BREAK
```

Sorting and Selecting Records in a Free-Form Report

As with tabular and matrix reports, you can both sort a report and conditionally select records for it. Use the same commands as for tabular and matrix reports. For example, use the BY phrase to sort a report and define WHERE criteria to select records from the data source.

Creating Graphs: GRAPH

Graphs often convey meanings more clearly than data listed in tabular report format. The FOCUS GRAPH command acts in the same way as the TABLE command to retrieve data from a file, but presents the information—either on the screen or to a printer—in one of five standard graphic formats:

- A connected point or line plot.
- A histogram.
- A bar chart.
- A pie chart.
- A scatter diagram.

Introduction

The following topics explain how to generate each graph form and adjust the features on the graphs you produce.

The examples in this chapter are drawn on the SALES database that is included on your system tape. All of the examples assume that FOCUS default parameters, called SET parameters, are in effect.

The SALES database is used to illustrate the examples used in this chapter. The Master File and a schematic diagram of the file appear in Appendix A, *Master Files and Diagrams*. An additional temporary field named SALES has been defined, and is used in many of the examples:

```
DEFINE FILE SALES  
SALES/D8.2=RETAIL_PRICE * UNIT_SOLD;  
END
```

GRAPH vs. TABLE Requests

GRAPH request syntax is similar to TABLE request syntax. In fact, the output from many TABLE requests can be converted directly into a graph by typing the command REPLOT at the FOCUS command prompt immediately after the output of the request has been displayed. For example:

```
DEFINE FILE SALES
SALES/D8.2=RETAIL_PRICE * UNIT_SOLD;
END

TABLE FILE SALES
HEADING CENTER
"SAMPLE TABLE REPORT FOR REPLOTTING"
SUM SALES ACROSS CITY
END
```

produces the following:

SAMPLE TABLE REPORT FOR REPLOTTING			
CITY			
NEW YORK	NEWARK	STAMFORD	UNIONDALE
224.88	56.08	535.34	151.85

To convert the output into a graph, exit the report, and at the FOCUS command prompt, type:

```
REPLOT
```

and press Enter.

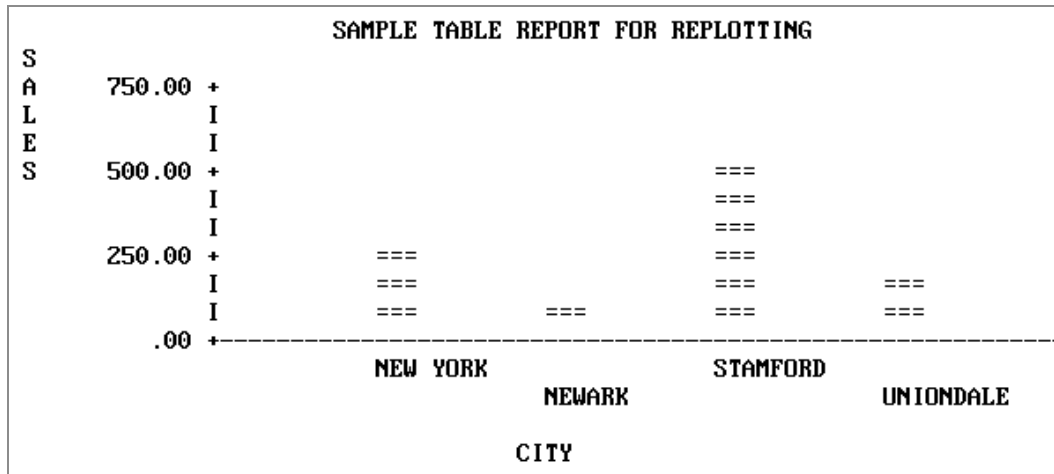

To produce the graph without creating a preliminary tabular report, substitute the command GRAPH for TABLE in the original request, as shown in the following:

```

DEFINE FILE SALES
SALES/D8.2=RETAIL_PRICE * UNIT_SOLD;
END

GRAPH FILE SALES
HEADING CENTER
"\"SAMPLE TABLE REPORT FOR REPLOTTING\""
SUM SALES ACROSS CITY
END
    
```

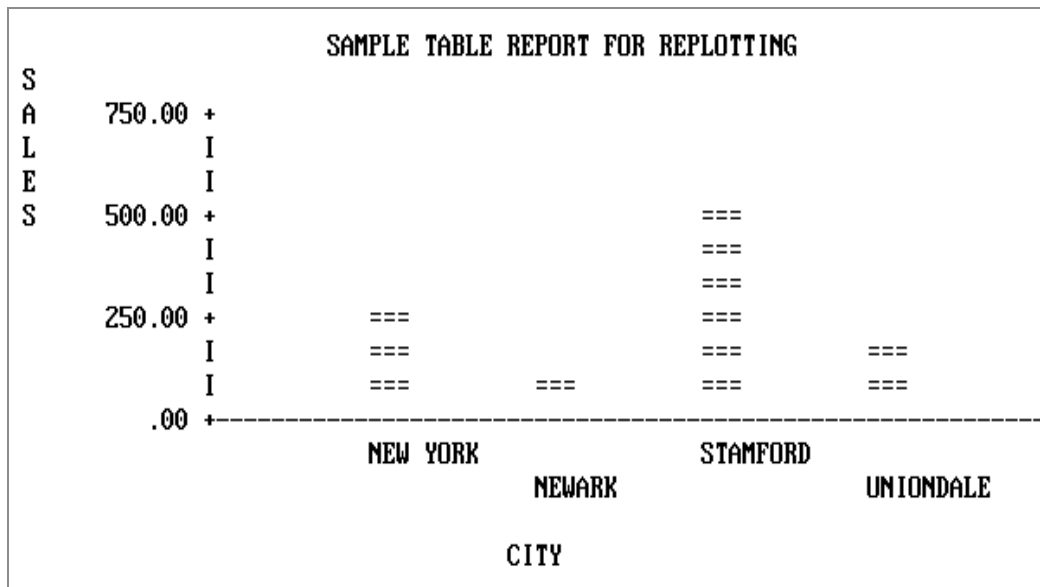

Thus, you can produce graphs by converting TABLE requests, but every TABLE facility does not have a GRAPH counterpart, and there are some practical limitations on the amount of

information that you can effectively display in a graph. [Command Syntax](#) describes the use of TABLE features in GRAPH requests.

The type of graph (graph form) produced by a GRAPH request depends on the verb used (such as SUM or PRINT), the sort phrase used (ACROSS or BY), and the data type of the sort field. Consider the five graphs that appear on the following pages, and the requests that produce them.

```
SET HISTOGRAM=OFF
DEFINE FILE SALES
SALES/D8.2=RETAIL_PRICE * UNIT_SOLD;
END

GRAPH FILE SALES
HEADING CENTER
"SAMPLE CONNECTED POINT PLOT"
SUM SALES ACROSS DATE
END
```

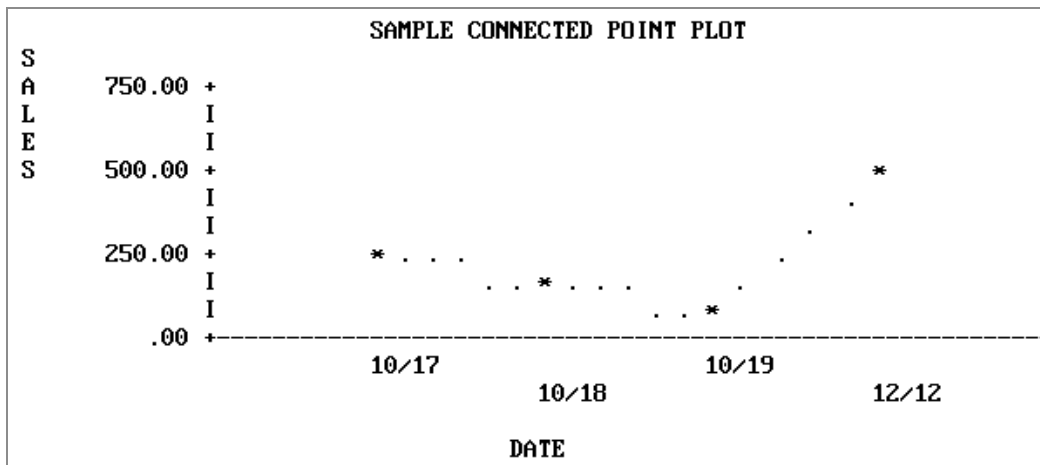

i **Note:** SET parameters remain in effect until you reset them or log off (see [Command and SET Parameter Summary](#)).

```
SET HISTOGRAM=ON
DEFINE FILE SALES
SALES/D8.2=RETAIL_PRICE * UNIT_SOLD;
END

GRAPH FILE SALES
HEADING CENTER
```

```
"SAMPLE HISTOGRAM"
SUM SALES ACROSS PROD_CODE
END
```

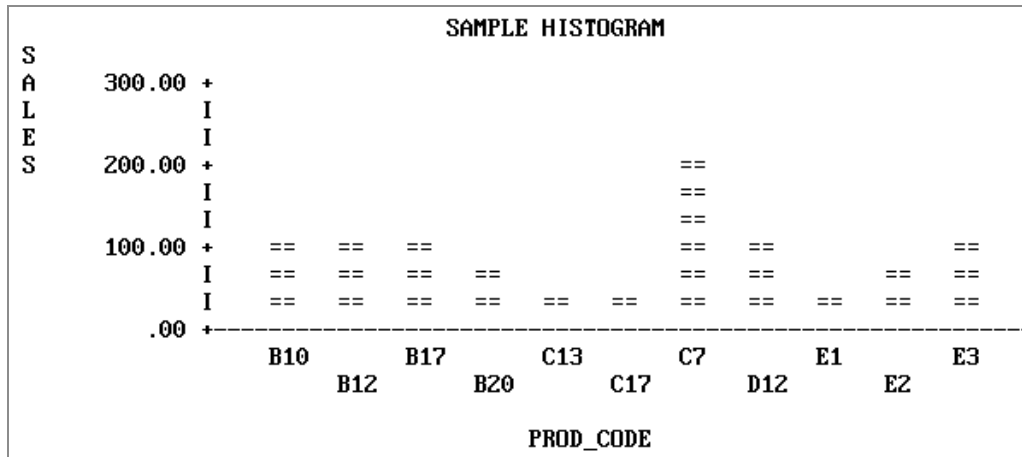

```
SET BARWIDTH=2, BARSPACE=2
DEFINE FILE SALES
SALES/D8.2=RETAIL_PRICE * UNIT_SOLD;
END
```

```
GRAPH FILE SALES
HEADING CENTER
"SAMPLE BAR CHART"
SUM SALES BY CITY
END
```

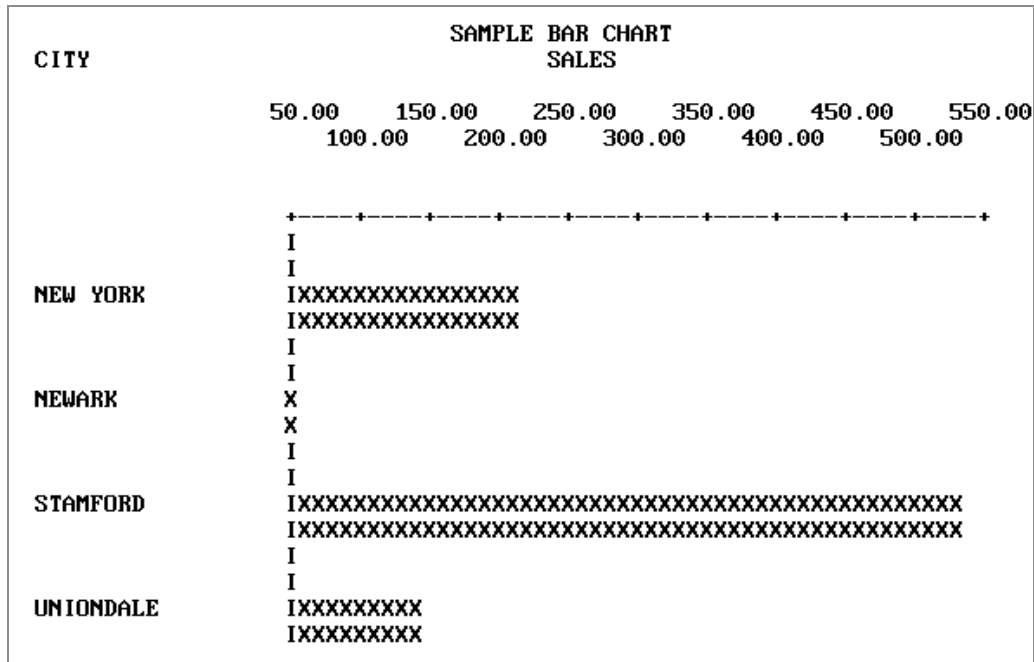



```

DEFINE FILE SALES
SALES/D8.2=RETAIL_PRICE * UNIT_SOLD;
END

SET PIE=ON, GCOLOR=OFF
SET VAXIS=50, HAXIS=100

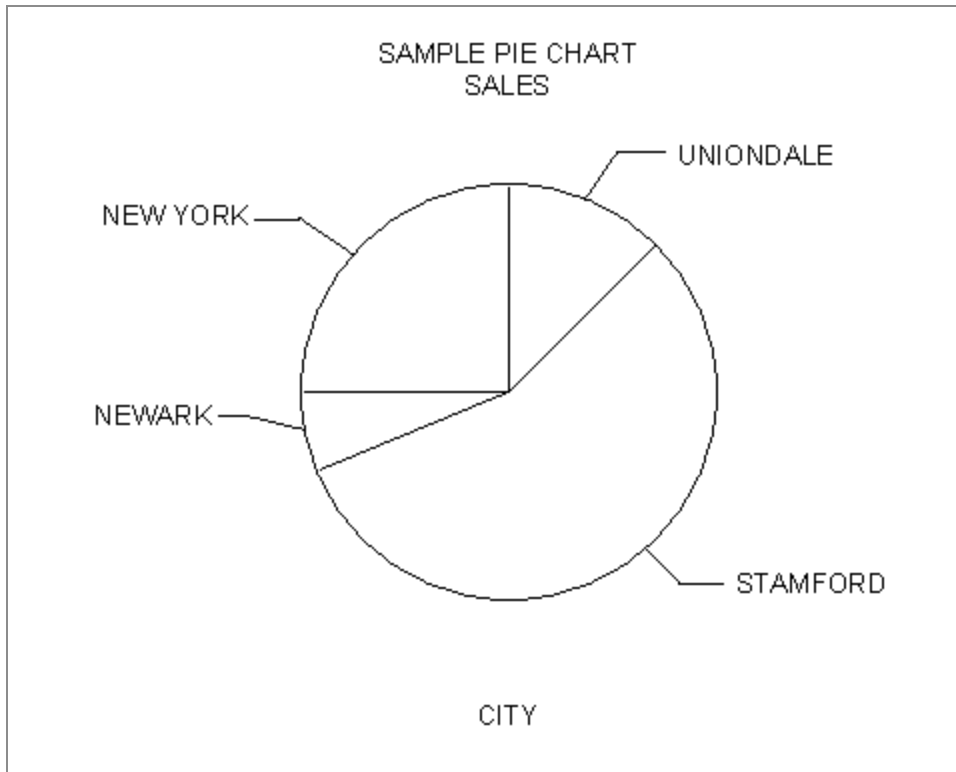
GRAPH FILE SALES
HEADING CENTER
"SAMPLE PIE CHART"
SUM SALES ACROSS CITY
END
    
```



```
SET HISTOGRAM=OFF
```

```
GRAPH FILE SALES  
HEADING CENTER  
"SAMPLE SCATTER DIAGRAM"  
PRINT UNIT_SOLD ACROSS PROD_CODE  
END
```

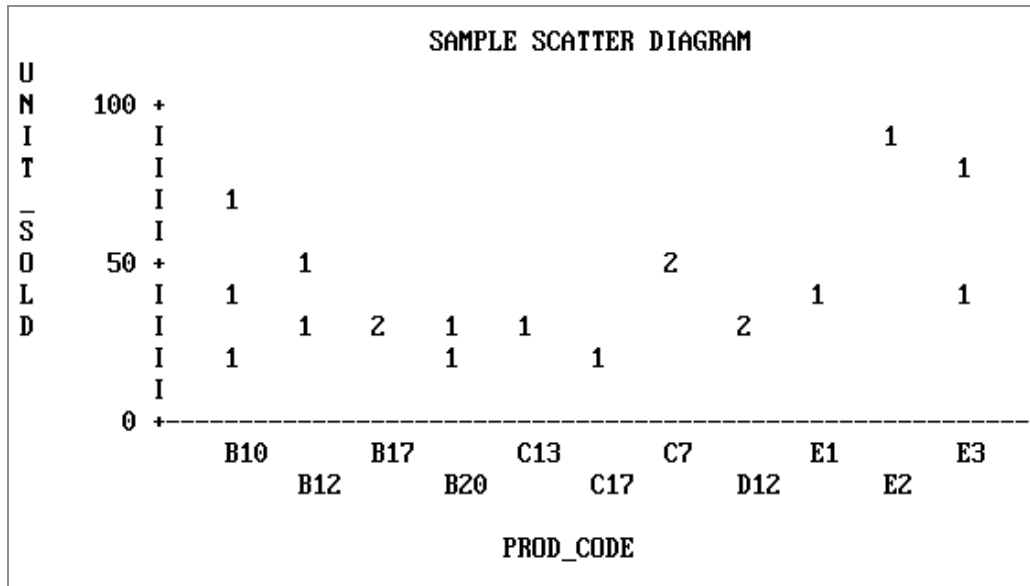

Running Graph Requests Offline

Certain options in a graph request may prevent the graph from displaying properly on the screen. In this case, you can run the graph request offline, and spool the output to a sequential file.

Run a Graph Request Offline

Procedure

1. Create a sequential file to contain the graph output and allocate it to DDNAME OFFLINE. For example:

```
DYNAM ALLOC DD OFFLINE DA USER1.OFFLINE.DATA SHR REU
```

Note that the LRECL for the sequential file should be 132.

2. Issue the following command to route graph output to this file:

```
OFFLINE
```

Result

If you want to run a request online after issuing the OFFLINE command, issue the ONLINE command:

```
ONLINE
```

You can then issue the OFFLINE command to run a request offline.

Each new graph request that is run offline appends its output to this file until you issue the following command:

```
OFFLINE CLOSE
```

Controlling the Format

In each of the previous graphs, FOCUS created a clear representation of the data using default values for the graph features (such as axis lengths, axis scales, or titles). You can issue your initial request and concentrate on selecting the data, while FOCUS controls all of the features on the graph.

When satisfied with the data portrayed in your graph, you can refine its appearance by adjusting the parameters that control the look of the graph. You can set the control parameters individually (for example, SET GRID=ON), or ask FOCUS to prompt you for all of their values when you execute the SET GPROMPT=ON command.

i Note: When entering several SET parameters on one line, separate them with commas.

The request below illustrates some of the parameters you can control when running the graph offline:

```
SET HISTOGRAM=OFF
SET HAXIS=75, VAXIS=32, GRID=ON
SET AUTOTICK=OFF, VCLASS=100, VTICK=20
DEFINE FILE SALES
SALES/D8.2=RETAIL_PRICE * UNIT_SOLD;
END
```

```

GRAPH FILE SALES
HEADING
"</1 <20 ILLUSTRATION OF"
"<23 GRAPH FEATURES AND CONTROLS"
SUM SALES AND UNIT_SOLD ACROSS PROD_CODE
FOOTING CENTER
"</1 <MIN.RETAIL = CHEAPEST ITEM"
END
    
```

The graph generated OFFLINE in response to the request appears below.

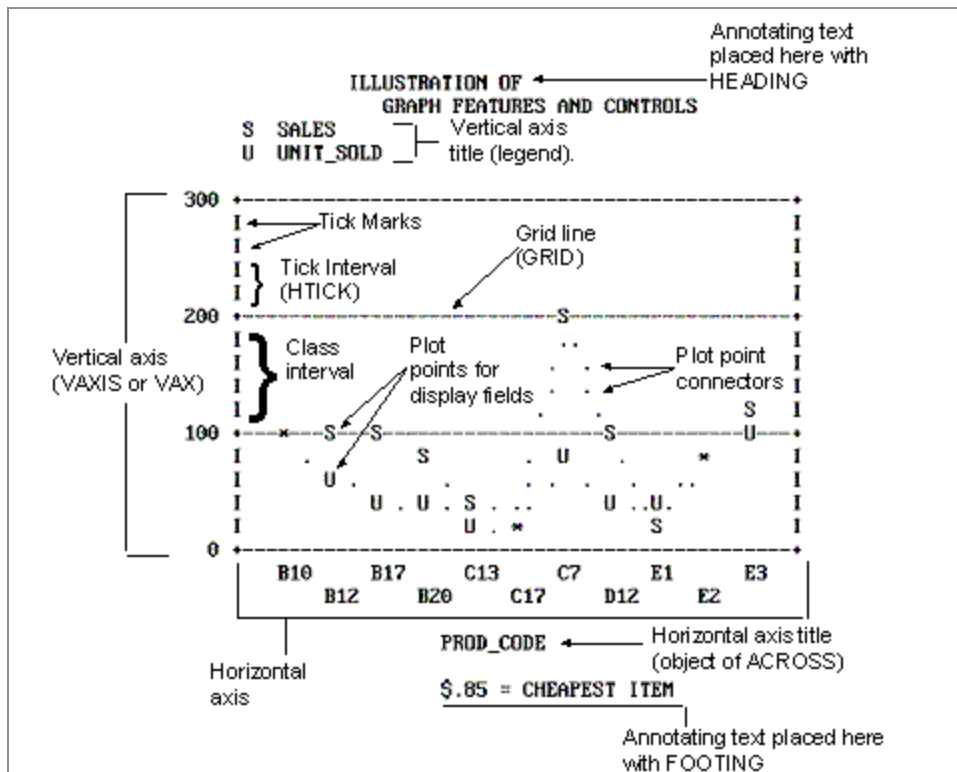

i Note:

- This graph is a connected point plot, with the plot points representing the sales (`retail_price * unit_sold`) and total units sold for each of the product codes listed across the horizontal axis.
- Annotating text has been added above and below the graph with the `HEADING` and `FOOTING` facilities. Note the use of spot markers to position text on the graph, and the embedded calculation with a direct operator.
- Only the vertical axis is scaled because the `ACROSS` phrase objects were not numeric values. The plus symbols (+) mark the class intervals on the axis scale, and vertical bars mark the tick intervals.
- Horizontal grid lines appear at the vertical class marks.

For graphs generated ONLINE, FOCUS automatically detects the height and width of a particular terminal and plots the graph accordingly. As a result, `VAXIS` and `HAXIS` settings are ignored.

You control the graphic elements shown in the previous figure, Illustration of Graph Features and Controls, in one of two ways: either by the syntax in the actual request, or with `SET` commands. [Command Syntax](#) describes the elements in `GRAPH` requests and their effects. [Adjusting Graph Elements](#) describes the adjustable parameters that control graph features.

There are some additional `SET` parameters that control non-graphic elements:

- Specifying an output device.
- Pausing between data retrieval and printing to permit the user to adjust paper in the printer or plotter.
- Using special black/white shading patterns to simulate different colors.
- Displaying the current settings of the `GRAPH` parameters on the screen.

After retrieving data from a file and displaying it either as a tabular report or a graph, you can use the `SET` command to adjust the format and then redisplay the graph by issuing the `REPLOTT` command (without resorting to further data retrieval).

A summary of all of the `SET` parameters appears in [Command and SET Parameter Summary](#).

Graphic Devices Supported

You may create graphs on any terminal or printer that can print FOCUS reports. If your terminal has no graphics capabilities, FOCUS uses the characters in the standard character set when producing graphs. As the default, FOCUS sends GRAPH output to the terminal (or system printer, if PRINT=OFFLINE). This produces low-resolution graphics. The examples in the chapter thus far (except the pie chart) illustrate the default. You cannot create continuous line plots or pie charts unless you have a high-resolution graphic device.

While FOCUS can accommodate devices with no inherent graphics capabilities, it can also take advantage of whatever graphics facilities are available. Some personal computers offer ranges of special characters that can be used to create more readable graphs. The following figure shows a graph on an IBM PC mono screen:

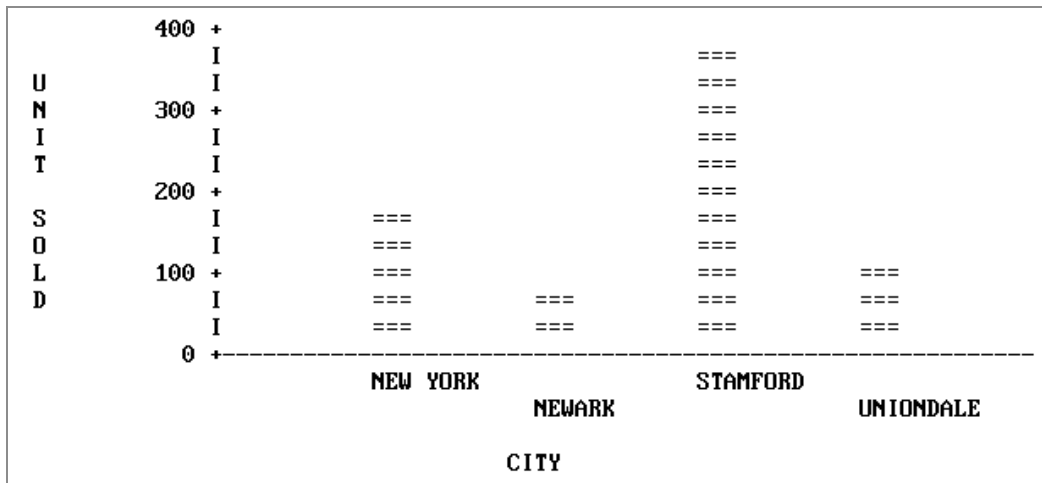

If color monitors or multiple-pen plotters are available, graph quality can be improved. The following figure shows a sample graph on a plotter. For more information, see [Special Graphics Devices](#).

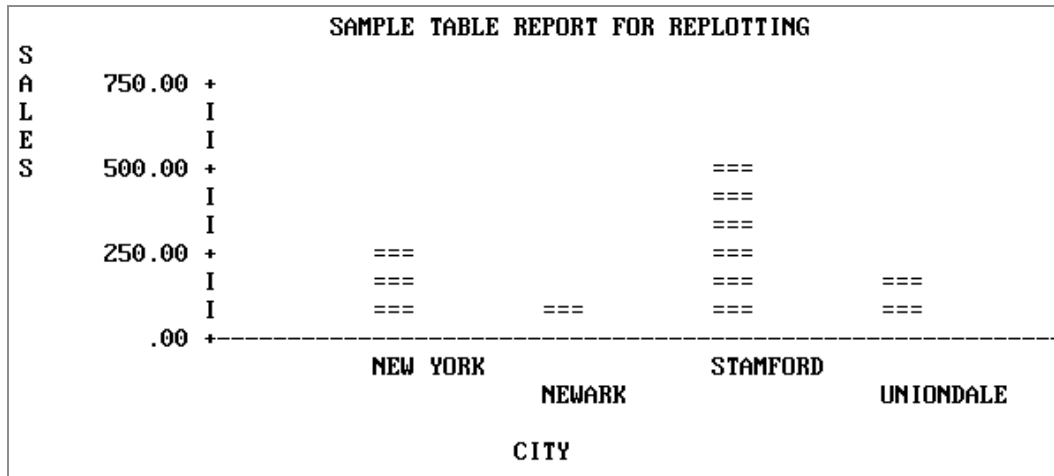

On IBM mainframes, FOCUS supports the use of high-resolution terminals such as the Model 3279 via the IBM Graphical Data Display Manager (GDDM), which is discussed in [IBM Devices Using GDDM](#). Other high-resolution terminals, printers, and plotters are also supported, and they are listed in this section. To select one, simply enter the appropriate form of the SET DEVICE command (see [High-Resolution Devices](#)). Note, in reviewing the device selections, that all have fixed graphic window dimensions (horizontal and vertical axes), which are fixed until a new device is selected.

Please note that this list includes only fully tested devices, although other devices may also work with FOCUS.

Medium-Resolution Devices

Anderson Jacobson Models: AJ830, and AJ832 (12 Pitch).

Diablo Models: 1620, and 1620 (12 Pitch).

Gencom Models: GENCOM, and GENCOM (12 Pitch).

Trendata Models: Trendata 4000A, and 4000A (12 Pitch).

High-Resolution Devices

IBM Graphic Devices (GDDM is required).

- Any IBM 3270 series device that supports GDDM graphics, such as 3279-S3G, 3179, or

3472. This includes PCs with fully compatible 3270 series hardware and software.

Hewlett-Packard Plotters:

- Four-pen plotters without paper advance: Models 7220A, 7221, and 7470A (requires Y cable #17455).
- Four-pen plotters with paper advance: Models 7220S and 7221S.
- Eight-pen plotters without paper advance: Models 7220C, 7221C, 7475A (requires Y cable #17455).
- Eight-pen plotters with paper advance: Models 7220T, 7221T.

Tektronix Graphic Devices (only monochrome display).

- Models 4010, 4012, 4013, 4014, 4014E, 4015, 4015E, 4025, 4027, 4050 series, 4662, and 4100 series.

Command Syntax

Most TABLE requests can be converted into GRAPH requests by replacing the TABLE command with the GRAPH command. The only limitations are those inherent in the graphic format. When a TABLE request is converted in this manner, the phrases that make up the request take on special meanings that determine the format and layout of the graph.

This section outlines the phrases that can appear in TABLE requests, and describes their effects in the context of GRAPH requests. It also describes any limitations that apply to their use.

GRAPH vs. TABLE Syntax

The syntax of the GRAPH command parallels that of the TABLE command. The main elements of GRAPH requests are the verb phrase (display command), one or more sort phrases, selection phrases, and headings and footings. All of the other phrases that appear in TABLE requests are ignored. This applies to all control conditions (ON...) and all IN phrases.

The basic GRAPH syntax is as follows:

```

GRAPH FILE filename
[HEADING]
[heading phrase]
verb phrase
sort phrase
[additional sort phrases]
[selection phrase(s)]
[FOOTING]
[footing phrase]
END

```

The GRAPH request elements generally follow the same rules as their TABLE counterparts:

- The word FILE and the file name must immediately follow the GRAPH command, unless they were previously specified in a SET command:

```
SET FILE=filename
```

The file named can be any file available to FOCUS, including joined or cross-referenced structures.

- You can concatenate unlike data sources in a GRAPH request with the MORE command. See [Concatenating Unlike Data Sources](#).
- The order of the phrases in the request does not affect the format of the graph. For example, the selection phrase may follow or precede the verb phrase and sort phrase (s). The order of the sort phrases does affect the format of the graph, however, just as the order of the sort phrases in TABLE requests affects the appearance of the reports (see [Selecting Forms: BY and ACROSS Phrases](#)).
- The word END must be typed on a line by itself to complete a GRAPH request.
- An incomplete GRAPH request can be terminated by typing the word QUIT on a line by itself, instead of END.
- All dates are displayed in MDY format unless they are changed to alphanumeric fields.

There are a few notable syntactical differences between TABLE and GRAPH. Specifically, the following restrictions apply:

- GRAPH requests must contain at least one sort phrase (BY phrase or ACROSS phrase) and a verb with at least one object in order to generate a meaningful graph.
- Several BY phrases can be used in a request, in which case multiple graphs are created (one for each BY object). A single ACROSS phrase is allowed in a GRAPH

request, and requests for certain graph forms can contain both ACROSS and BY phrases.

- The number of ACROSS values cannot exceed 64.
- In GRAPH requests, the verb object must always be a numeric field.
- No more than five verb objects are permitted in a GRAPH request. This limitation is necessary because standard graph formats generally do not permit more variables to be displayed without rendering the graph unreadable.
- The RUN option is not available as an alternative to END.

The following sections describe the functions performed by each of the phrases used in GRAPH requests.

Specifying Graph Forms and Contents

Each graph form is defined by a particular combination of verb and sort phrase. The combinations, which were illustrated earlier in [GRAPH vs. TABLE Requests](#), are summarized in the table below (A and B represent two field names).

```
Point plot:  SUM A ACROSS B (B is numeric)
Histogram:  SET HISTOGRAM=ON
            SUM A ACROSS B (B is alpha)
Bar chart:  SUM A BY B
Pie chart:  SET PIE=ON
            SUM A ACROSS B
Scatter diagram: PRINT A ACROSS B or PRINT A BY B
```

Naming Subjects: Verb Phrases

Each GRAPH request must include a verb and at least one object (up to five are allowed). Three verbs are permitted: COUNT, SUM, and PRINT. SUM is synonymous with either WRITE or ADD. Each verb object must be a computational field (not alphabetic). For example:

```
GRAPH FILE SALES
SUM SALES
```

.

```

.
.

```

If the verb SUM (or WRITE or ADD) is used, then a bar chart, histogram, line plot or pie chart is produced, depending on the sort phrase and sort field format used. If PRINT is used, the graph is a scatter diagram.

The verb objects, which are the subjects of the graph, may be real or defined fields, with or without direct operation prefixes (AVE., MIN., MAX., etc.). They may also be computed fields. (All of the COMPUTE facilities are available in GRAPH requests.)

When the request has a single verb object, the vertical title of the graph is either the field name of the verb object as it appears in the Master File, or a replacement name supplied in an AS phrase.

When a request contains multiple verb objects, each represents one variable in the graph, and a vertical legend is printed instead of the vertical title. The legend specifies the field names (and/or AS phrase substitutions) and provides a key to which line represents each variable.

In your requests, verb objects may be separated by spaces, or by AND or OVER. OVER has special significance in histogram and bar chart requests, where it controls the stacking of the bars. This is described in the sections on Histograms (see [Graph Forms](#)), and Bar Charts (see [Graph Forms](#)).

Verb objects used only for calculations need not appear in your graphs. Use the NOPRINT or SUP-PRINT facilities to suppress the display of such fields.

Selecting Forms: BY and ACROSS Phrases

At least one sort phrase is required in every GRAPH request. This may be either a BY phrase or an ACROSS phrase.

For example:

```

GRAPH FILE SALES
SUM SALES
ACROSS PROD_CODE
.
.
.

```

The ACROSS phrase, if there is one, determines the horizontal axis of the graph.

If there is no ACROSS phrase, the last BY phrase determines the vertical axis. When there are multiple BY phrases or when an ACROSS and BY phrase are included in the same request, FOCUS generates multiple graphs; one for each combination of values for the fields referenced in the request (see [The Vertical Axis: System Defaults](#) for information regarding control of the vertical axis).



Note: The FOCUS ICU Interface saves data for IBM's Interactive Chart Utility (ICU) in tied data format. If both an ACROSS and BY phrase are present in a GRAPH request, one common axis is established. This enables FOCUS graphs to be displayed as tower charts.

The FOCUS ICU Interface is discussed in further detail in [Using the FOCUS ICU Interface](#). You can also consult the *ICU Interface Users Manual* for additional information.

The sortfield name may be replaced with an AS phrase. This is useful if the sort phrase specifies one of the axes (it has no effect on any additional sort phrases).

Note that the values of fields mentioned in the additional sort phrases are not displayed automatically in the graph. If you wish to have them appear, you must embed them in a heading or a footing line (see [Adding Annotating Text: HEADING and FOOTING Lines](#)).

Selecting the Contents: Selection Phrases

Selection phrases are used in GRAPH requests to select records of interest. Two phrases are available: IF and WHERE. The examples in this chapter use the IF selection phrase. For a definition of the WHERE clause and the differences between IF and WHERE, see Chapter 5, *Selecting Records for Your Report*.

The syntax for an IF phrase or a WHERE clause in a GRAPH request is identical to that used in a TABLE request. For example:

```
GRAPH FILE SALES
SUM SALES
ACROSS PROD_CODE
IF PROD_CODE NE D12
```

A partial list of the relation tests appears below. See Chapter 5, *Selecting Records for Your Report*, for a complete list.

Relation	Meaning
EQ	Equal to
NE	Not equal to
GE	Greater than or equal to
GT	Greater than
LE	Less than or equal to
LT	Less than
CONTAINS	Contains
OMITS	Omits

Concatenating Unlike Data Sources

With the FOCUS command MORE, you can graph data from unlike data sources in a single request; all data, regardless of source, appears to come from a single file. You must divide your request into:

- One main request that retrieves the first file and defines the data fields, sorting criteria, and output format for all data.
- Subrequests that define the files and fields to be concatenated to the data of the main request. The fields printed and sorted by the main request must exist in each

concatenated file. If they do not, you must create them as DEFINE fields.

During retrieval, FOCUS gathers data from each database in turn. It then sorts all data, and formats the output as described in the main request. The syntax is:

```
GRAPH FILE file1
main request
MORE
FILE file2
subrequest
  MORE
  .
  .
  .
END
```

where:

file1

Is the name of the first file.

main request

Is a request, without END, that describes the sorting, formatting, aggregation, and COMPUTE field definitions for all data. IF and WHERE phrases in the main request apply only to *file1*.

MORE

Begins a subrequest. The number of subrequests is limited only by available memory.

FILE file2

Defines *file2* as the second file for concatenation.

subrequest

Is a subrequest. Subrequests can only include WHERE and IF phrases.

END

Ends the request.

See [Merging Data Sources](#), for complete information and for concatenation examples.

Adding Annotating Text: HEADING and FOOTING Lines

To insert annotating text above or below a graph, enter the keywords HEADING and/or FOOTING, followed by the desired contents, including any necessary control elements for skipping lines. The syntax is the same as that used for headings and footings in TABLE requests.

For example:

```
GRAPH FILE SALES
HEADING
"<7 THIS GRAPH SHOWS SALES BY PRODUCT CODE"
SUM SALES
BY PROD_CODE
IF PROD_CODE NE D12
FOOTING
"<7 FOR ALL PRODUCT CODES EXCEPT D12"
END
```



Note: When annotating text falls in the path of a plot point on a graph, the plot point is printed; however, connecting points are suppressed if they lie in the path of annotating text. This enables you to adjust the position of the annotated text when you see the contents of the graph. The first line of any heading appears above the first line of the legend.

Inserting Formatting Controls

The formatting controls used in TABLE requests can also be used in GRAPH requests for positioning text or field references in heading or footing lines, or in the body of your graph. The following example shows the use of spot markers, which are described in Chapter 9, *Customizing Tabular Reports*. Run the following request offline to generate the graph shown immediately following the request:

```
SET HISTOGRAM=OFF
SET AUTOTICK=OFF, VCLASS = 200, VTICK = 25
GRAPH FILE SALES
```



```

HEADING
"</4 <22 GRAPH SHOWING HOW TO EMBED"
"<22 ANNOTATING TEXT"
"</10 <15 ANYWHERE ON THE GRAPH"
SUM UNIT_SOLD AND OPENING_AMT AS 'INVENTORY'
ACROSS DATE AS '          PERIOD COVERED'
FOOTING CENTER
"AVERAGE STOCK ON HAND WAS <AVE.OPENING_AMT"
END

```

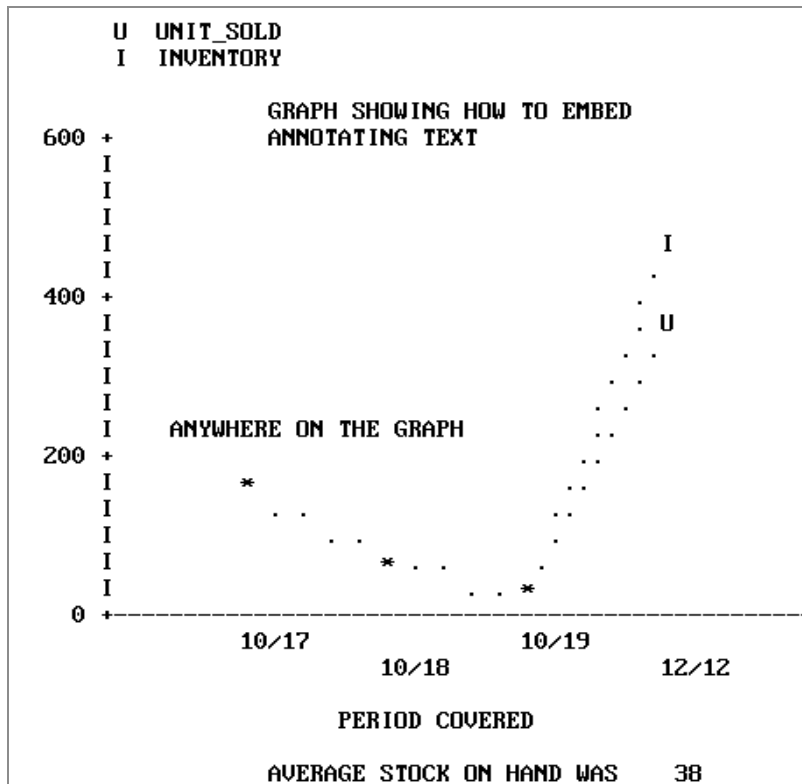

Inserting Field References

The following example shows how to embed field values in graph heading or footing lines, similar to the capability in TABLE requests. It is useful when annotating graphs created by requests containing multiple sort fields (where only the first named sort field appears as a title on the graph). Run the following as an offline request:

```

SET HISTOGRAM=OFF
SET AUTOTICK=OFF, VCLASS = 50 , VTICK = 8
DEFINE FILE SALES
SALES/D8.2=RETAIL_PRICE * UNIT_SOLD;
END
GRAPH FILE SALES
HEADING CENTER
"GRAPH WITH DEFINED AND COMPUTED FIELDS"
SUM SALES AND UNIT_SOLD AND OPENING_AMT
AS 'INVENTORY' AND
COMPUTE OVERHEAD/D8.2=.20 * SALES;
ACROSS DATE AS ' PERIOD COVERED'
BY PROD_CODE
IF PROD_CODE IS 'C7' OR 'B10' OR 'B12'
FOOTING CENTER
"REPORT FOR PRODUCT <PROD_CODE>"
END

```

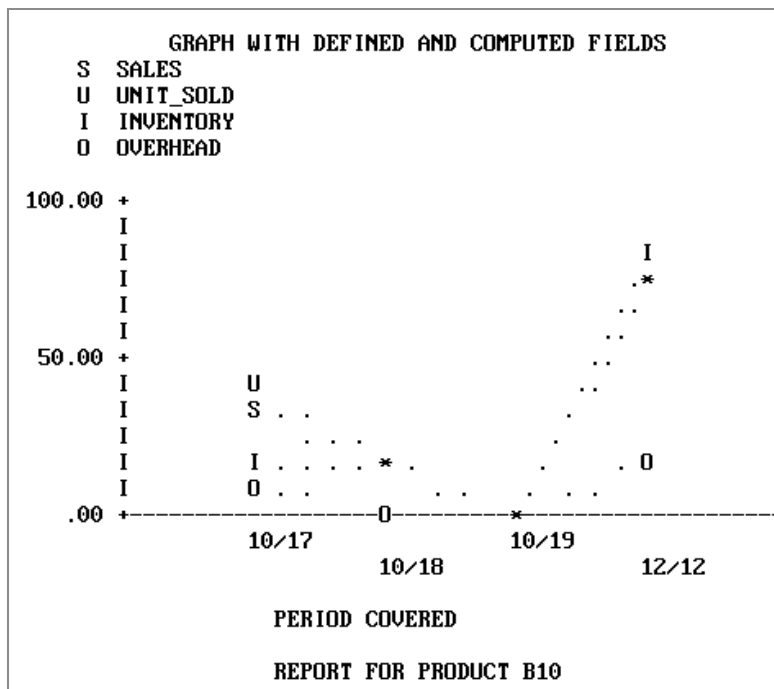

Graph Forms

This section describes the five graph forms produced by FOCUS, and their basic elements. Connected point plots are described first, followed by histograms, bar charts, pie charts,

and scatter diagrams. The adjustable graphic features are mentioned only briefly with the graph forms and fully described in [Adjusting Graph Elements](#).

As seen in the examples in [GRAPH vs. TABLE Requests](#), there are similarities between the requests for some of the forms. For example, a request for a connected point plot (with an alphanumeric ACROSS field) creates a histogram instead if the HISTOGRAM parameter is set on (the default). This feature enables you retrieve data once, then switch from one form to the other by changing the HISTOGRAM value and issuing REPLOT.

Histograms are often called vertical bar charts, but the physical similarities between these forms mislead users. Although the graphs look similar and have parameters that perform similar functions (HSTACK and BSTACK), the parameters used to control the widths and spacing of bars on bar charts have no effect on histogram bars.

Histograms and vertical scatter plots (those created with BY phrases) have variable-length vertical axes that are not subject to the VAXIS parameter setting.

Pie charts and bar charts are different geometrical representations of similar types of data, but pie charts are only possible if you have a high-resolution device capable of drawing respectable curves.

Connected Point Plots

Create a connected point plot (or a line plot on a high-resolution device), with a request that combines the verb SUM (or the synonyms WRITE or ADD) with an ACROSS phrase that specifies an alphanumeric or a numeric field. If the field specified in the ACROSS phrase is alphanumeric, the HISTOGRAM parameter must be set off in order to generate a connected point plot.

The values for the field named in the ACROSS phrase are plotted on the horizontal axis, and the values for the verb object(s) are plotted along the vertical axis.

The example below illustrates a point plot request.

```
SET HISTOGRAM=OFF

SET VAXIS=40,HAXIS=75
GRAPH FILE SALES
HEADING CENTER
"SAMPLE CONNECTED POINT PLOT"
SUM SALES ACROSS DATE
END
```

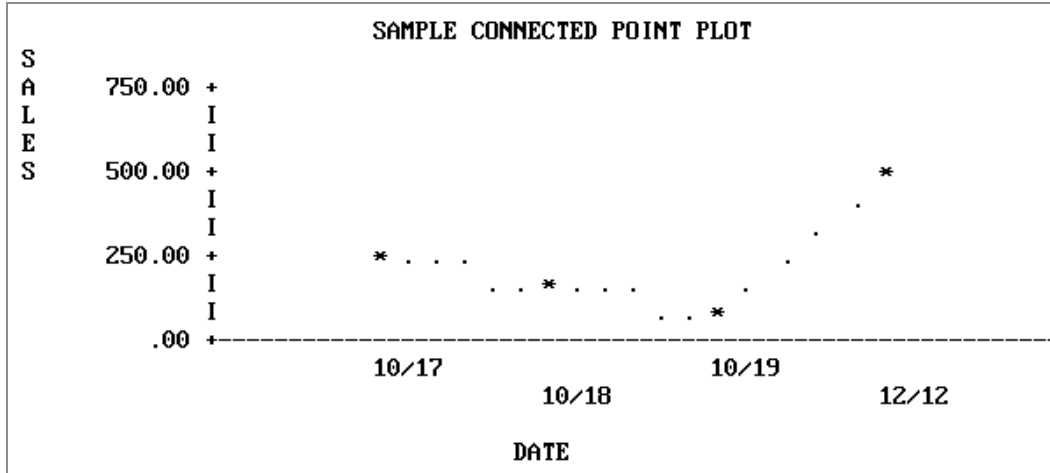

i Note: The SET statements in the previous example were added to limit the output graph to a convenient size for display on the page. Without them, FOCUS sets the default horizontal axis width at the capacity of the device selected, and a vertical height of 66 lines, the normal page length.

Point Plot Features

- **Scale Titles.** The values associated with the class markers are printed below the horizontal axis in the USAGE format of the variable being plotted (MM/DD in our example).
- **Plot Characters.** The graphics characters used to plot the variables on connected point plots depend on the type of display device:
 - On high-speed printers and non-graphics terminals, the data points are represented by asterisks (*) when only one variable is plotted. If several variables are plotted, the initial letters of the variable names are used (rename duplicates with AS phrases). The data points are connected by periods (.). You cannot create continuous line plots, as they are only available on high-resolution devices.
 - On high-resolution displays, printers, and plotters, the lines connecting plot points are drawn explicitly. When there are several variables, they are distinguished either by color or by the type of connecting line used (dotted, solid, or broken).

- **Axis Titles.** You can include vertical and horizontal axis titles for your graphs:
 - For requests with a single verb object, the vertical title is either its field name or a replacement name you have provided in an AS phrase.
 - When more than one variable is plotted, FOCUS prints a vertical legend instead of the vertical title. The legend specifies the field names or their replacements, and provides a key showing which line represents each variable. Titles are displayed staggered or folded on successive horizontal lines to permit more titles than a single horizontal line can contain.

The following example illustrates a point plot with several variables, run offline.

```

SET HISTOGRAM=OFF
SET AUTOTICK=OFF, VCLASS = 200, VTICK = 25
DEFINE FILE SALES
SALES/D8.2=RETAIL_PRICE * UNIT_SOLD;
END
GRAPH FILE SALES
HEADING
"POINT PLOT WITH SEVERAL VARIABLES"
SUM SALES AND UNIT_SOLD AND INV AS 'ON HAND'
ACROSS DATE
END
  
```

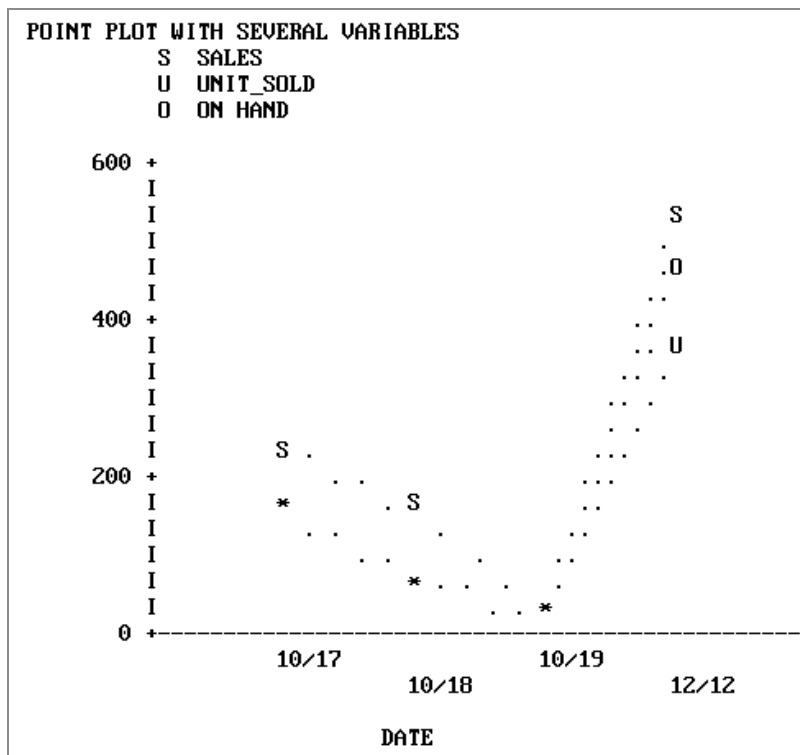

Up to five variables can be plotted on the same vertical axis. The scale on the vertical axis is determined based on the combined values of the vertical variables, and a separate point appears for each value of each variable.

When planning graphs with multiple variables or large numbers, adjust your variables so they are in the same order of magnitude. By redefining the variable plotted on the horizontal axis by a suitable power of 10, you can make the finished graph more legible. A method for doing this is shown in the example below. Run this as an offline request:

```

DEFINE FILE SALES
SALES/D8.2=(UNIT_SOLD * RETAIL_PRICE)/10;
END
SET HISTOGRAM=OFF
SET AUTOTICK=OFF, VCLASS = 5 , VTICK = 1
GRAPH FILE SALES
HEADING CENTER
"STAMFORD'S SALES/10 AND RETURNS"
SUM SALES AND RETURNS ACROSS PROD_CODE
BY STORE
IF CITY IS 'STAMFORD'
FOOTING CENTER
"SALES FOR STORE # <STORE_CODE"
END

```

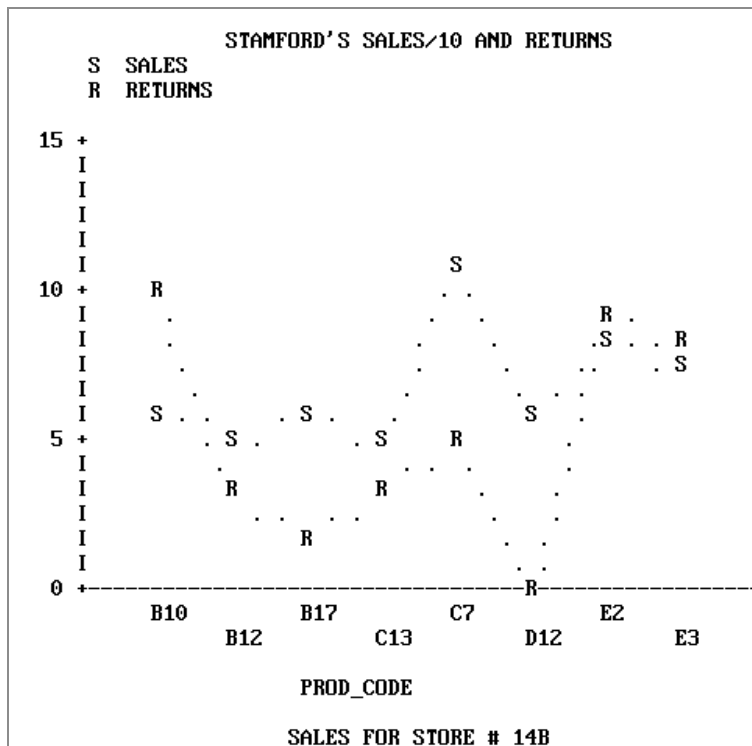

Histograms

Histograms are vertical bar charts, and are useful for portraying the component parts of aggregate values. They are an alternate graphic format for plotting requests that could also generate connected point plots. To switch from one format to the other, simply reset the parameter HIST and issue REPLOT.

Create histograms by typing requests containing the verb SUM (or the synonyms, WRITE or ADD) and an ACROSS phrase that specifies an alphanumeric field. One bar appears on the graph for each verb object. The example that follows illustrates a histogram with a single variable. Run it as an offline request:

```
SET HISTOGRAM=ON
SET AUTOTICK=OFF, VCLASS = 100, VTICK = 40
DEFINE FILE SALES
SALES/D8.2=(UNIT_SOLD * RETAIL_PRICE);
END

GRAPH FILE SALES
HEADING CENTER
"SAMPLE HISTOGRAM"
SUM SALES ACROSS PROD_CODE
END
```

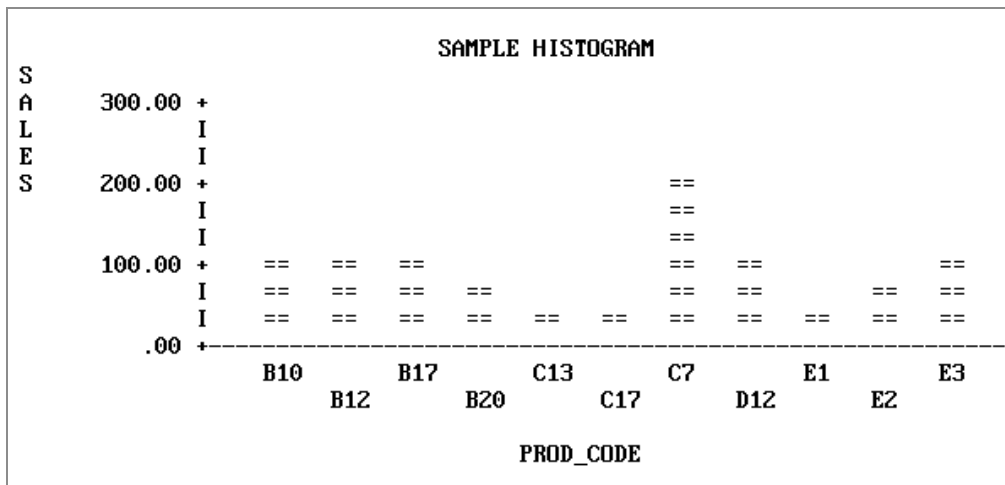

To draw the bars side by side, separate the verb objects with spaces or AND. To draw superimposed (stacked) bars, separate the verb objects with OVER. The example that follows illustrates a request using OVER. Run it as an offline request:

```

SET HISTOGRAM = ON
SET AUTOTICK=OFF, VCLASS = 200, VTICK = 20
DEFINE FILE SALES
SALES/D8.2=(UNIT_SOLD * RETAIL_PRICE) ;
END
GRAPH FILE SALES
HEADING
"SALES OVER INVENTORY AND RETURNS"
"ACROSS PRODUCT CODE"
SUM SALES OVER INV OVER RETURNS ACROSS PROD_CODE
END
    
```

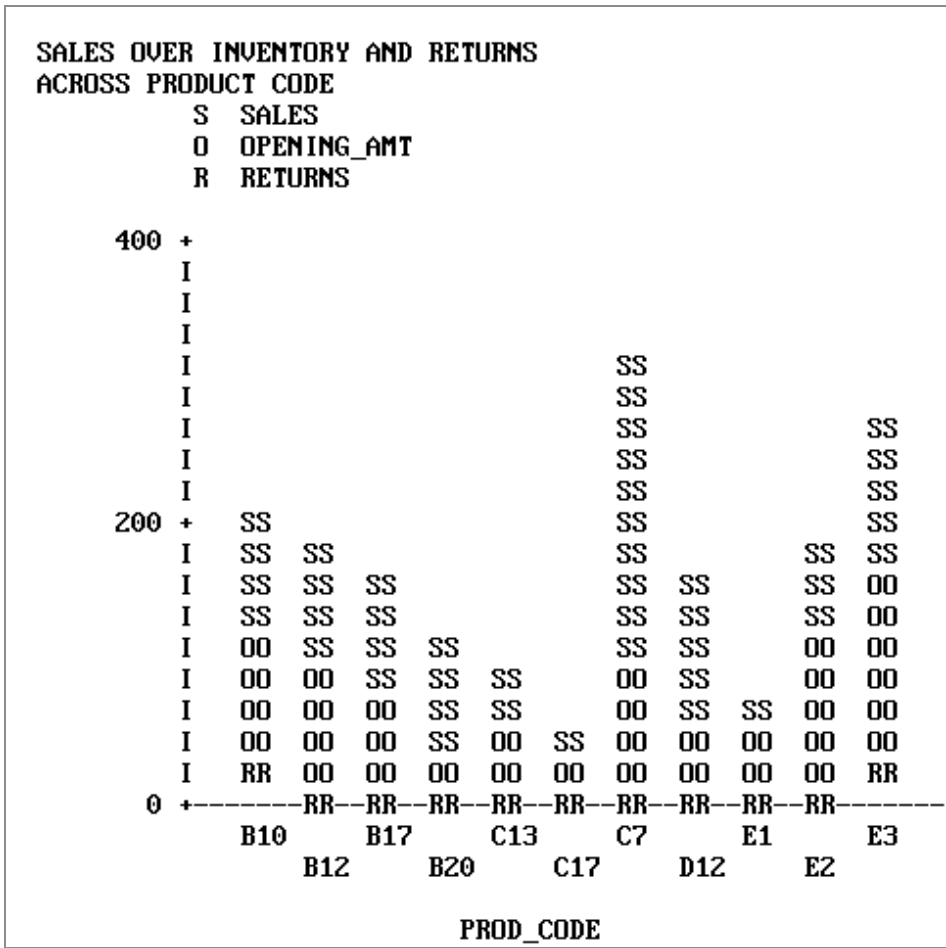

Note that the legend uses the full field names rather than the aliases for the verb objects (OPENING_AMT for INV).

When you name three or more verb objects in a request, you can have any combination of stacked and side-by-side bars.

Histogram Features

Each vertical bar or group of bars represents a value of the ACROSS sort field. The range of values for the verb objects determines the scale for the vertical axis.

All of the vertical axis features on histograms are adjustable:

- To reset the height of OFFLINE graphs, use the VAXIS parameter as described in [Adjusting Graph Elements](#). For online graphs, FOCUS automatically sets the height of your graph based on the terminal dimensions.
- Reset the upper and lower thresholds on the axis by setting the default scaling mechanism off (VAUTO) and setting new upper and lower limits (VMAX and VMIN). See [Set the Scale: Assigning Fixed Limits](#).
- Reset the class and tick intervals by overriding the default mechanism (AUTOTICK) and setting new intervals (VCLASS and VTICK). See [Set Class and Tick Intervals](#).

FOCUS automatically sets the width of the bars and the spacing between them to fit within the HAXIS parameter limit. These can be changed by resetting the HAXIS parameter (see [Adjusting Graph Elements](#)).

The values for the data points on the HAXIS are printed horizontally on a single line or staggered (folded) on two or more lines, depending on the available space.

To add a grid of parallel horizontal lines at the vertical class marks, issue the following SET command before issuing your request:

```
SET GRID=ON
```

Vertical grids are not available on histograms.

To specify stacking of all bars without using OVER in the request, you can set the parameter HSTACK (SET HSTACK=ON). Remember to set it off again before moving to other requests.

i Note: There is often confusion over histogram features because of the similarity with bar charts. The BARNUMB facility used to print summary numbers for the bars in bar charts does not work with histograms.

Bar Charts

Bar charts have horizontal bars arrayed vertically. To produce a bar chart, type a request containing the verb SUM and a BY phrase (but no ACROSS phrase). A separate group of bars is created for each value of the BY field, and each group contains one bar for each verb object in the request.

```
SET BARWIDTH=2, BARSPACE=1
```

```
GRAPH FILE SALES
HEADING
"BAR CHART"
SUM UNIT_SOLD BY CITY
IF PROD_CODE EQ B10
END
```

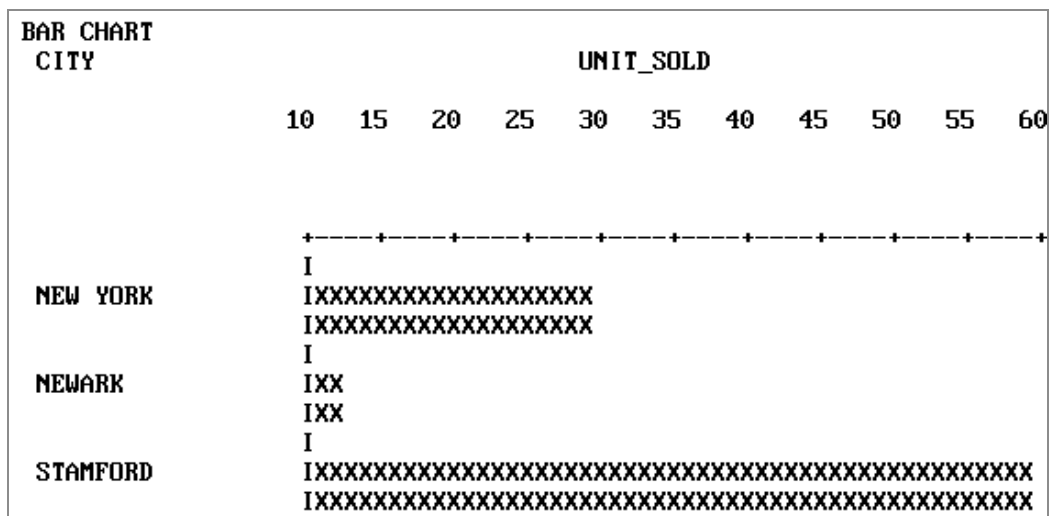

In the request above, the parameters BARSPACE and BARWIDTH were set to enhance the appearance of the graph and improve readability.

In requests with multiple verb objects, each bar appears beneath its predecessor by default. If verb objects are connected by OVER phrases, however, then the corresponding bars are stacked and appear end-to-end. The following example illustrates stacked bars.

```
SET BARSPACE=2, BARWIDTH=2
```

```
GRAPH FILE SALES
HEADING
```

```
"BAR CHART"
SUM DELIVER_AMT OVER INV BY CITY
WHERE PROD_CODE EQ 'B10'
END
```

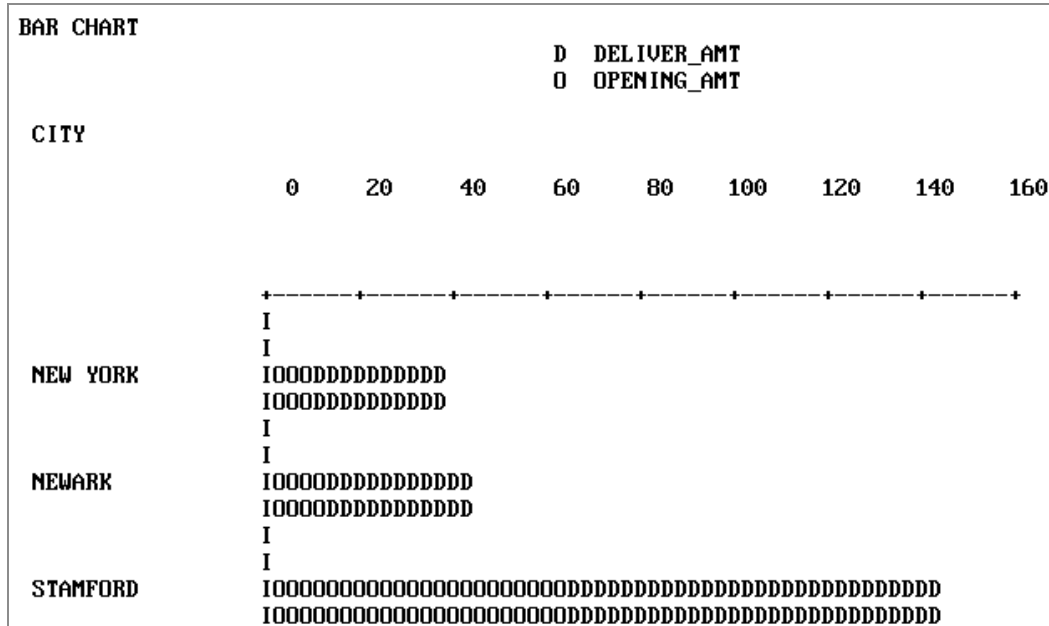

Alternatively, to request stacking of all bars, set the parameter BSTACK (SET BSTACK=ON). If you use BSTACK you do not need OVER; any graph can be replotted with and without stacking by simply changing the value of this parameter and issuing REPLOT.

Bar Chart Features

You can set the BARWIDTH parameter to change the widths of the bars themselves, and set the BARSPACE parameter to change the spacing between them. Set the GRID parameter to add a grid of vertical parallel lines at the class marks on the horizontal axis. The examples that follow illustrate the use of these parameters.

```
SET BARWIDTH=3, BARSPACE=2, BSTACK=OFF
DEFINE FILE SALES
SALES/D8.2=RETAIL_PRICE * UNIT_SOLD;
END

GRAPH FILE SALES
HEADING
```

```
"BAR CHART"
SUM AVE.SALES AND UNIT_SOLD BY CITY
WHERE PROD_CODE IS 'B10' OR 'B20'
FOOTING
"</2 CHANGING SPACING AND WIDTHS OF BARS"
END
```

The result follows:

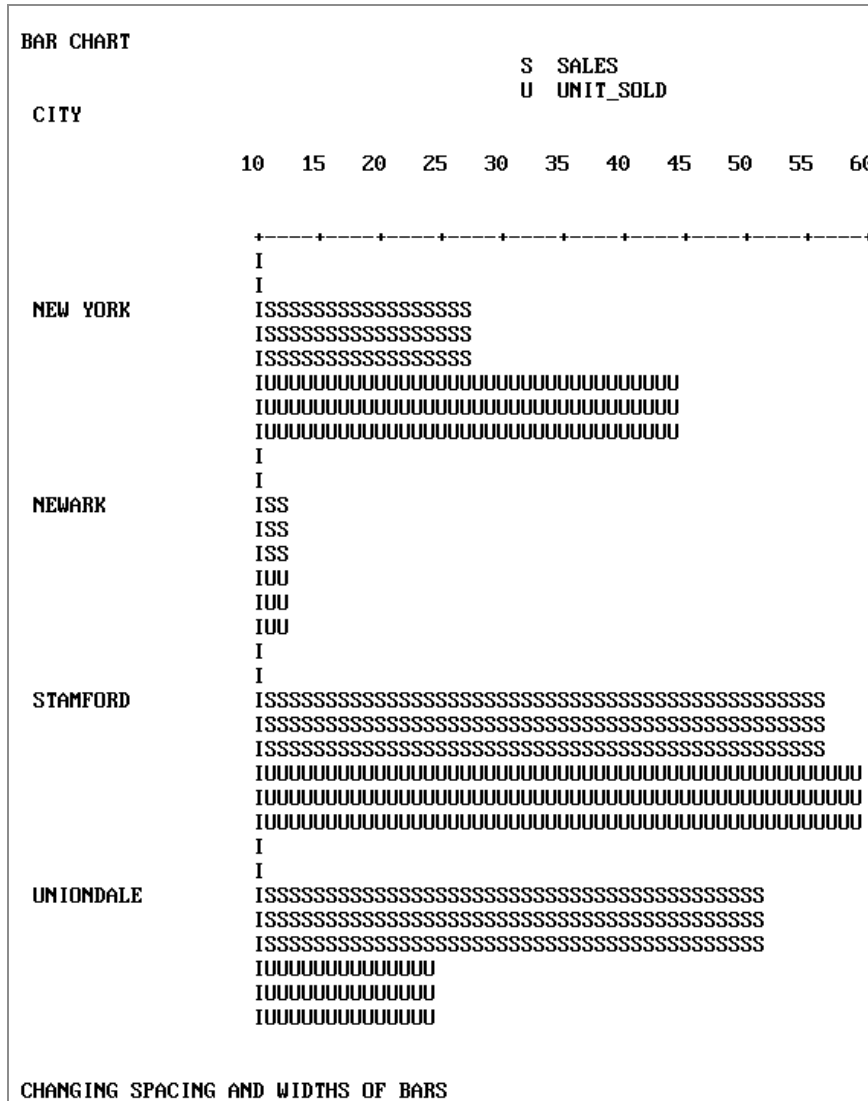

To print a summary value at the end of each bar, set the BARNUMB parameter.



Note: This feature is also available on pie charts, but is not available on histograms.

The effects of BARNUMB and GRID are shown below.

```

SET BARNUMB=ON, GRID=ON
DEFINE FILE SALES
SALES/D8.2=RETAIL_PRICE * UNIT_SOLD;
END

GRAPH FILE SALES
HEADING CENTER
"CHART WITH SUMMARY NUMBERS AND A GRID"
SUM AVE.SALES AND INV AND UNIT_SOLD BY CITY
WHERE PROD_CODE EQ 'B10' OR 'B20'
END
    
```

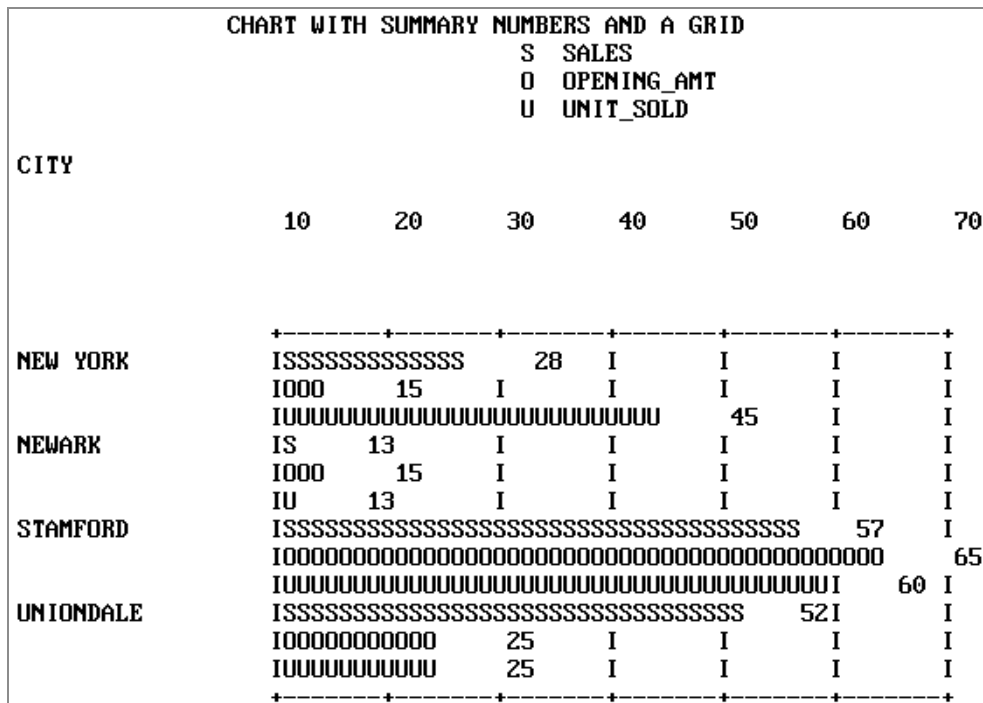

The horizontal axis features are all adjustable:

- To change the width of OFFLINE graphs, alter the HAXIS parameter as described in [Set the Width](#). For ONLINE graphs, FOCUS automatically detects the width of the terminal, and displays the graph accordingly.
- To reset the numerical scale, turn off the default scaling mechanism (HAUTO) and set new upper and lower limits (HMAX and HMIN). See [Set the Scale: Assigning Fixed Limits](#).
- To change the class and tick intervals, override the default mechanism (AUTOTICK)

and set new intervals (HCLASS and HTICK). See [Set Class and Tick Intervals](#).

The vertical axis length is controlled by FOCUS. You can set the bar widths and spacing as mentioned previously, but you cannot set the vertical height to a fixed dimension.

Pie Charts

Pie charts can only be drawn on high-resolution graphic devices. It is possible, however, to create a formatted pie chart and save it for subsequent plotting on another device. See [Saving Formatted GRAPH Output](#).

To create a pie chart, first set the PIE parameter ON and select a device (SET DEVICE=), then type a request with the verb SUM (or the synonyms, WRITE or ADD) and an ACROSS phrase that names an alphanumeric field. When you finish your pie charts, set the PIE parameter OFF before running other types of GRAPH requests.

```
SET PIE=ON, DEVICE=HP7220C
GRAPH FILE SALES
HEADING CENTER
"PIE CHART PRODUCED ON HEWLETT-PACKARD MODEL 7475"
WRITE RPCT.UNIT_SOLD ACROSS CITY
END
```

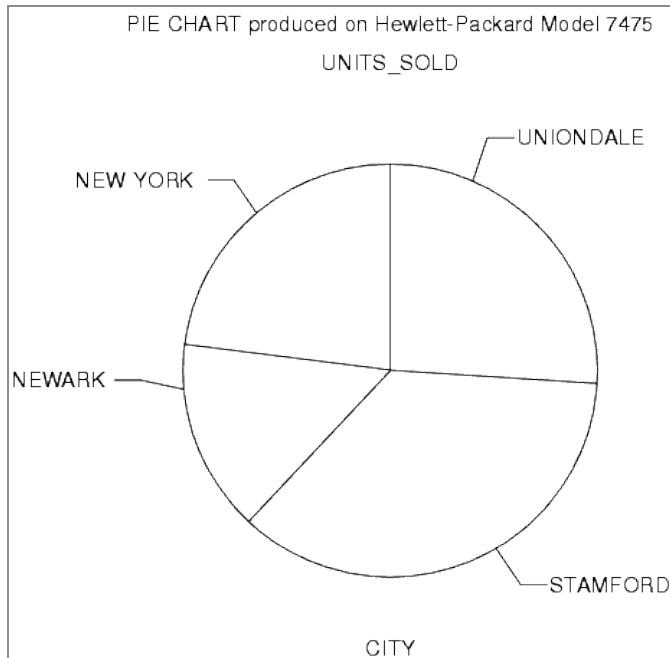

Pie Chart Features

To add summary numbers for each slice of the pie chart on the previous page, enter the following:

```
SET BARNUMB=ON
REPLOTT
```

The effect is shown below:

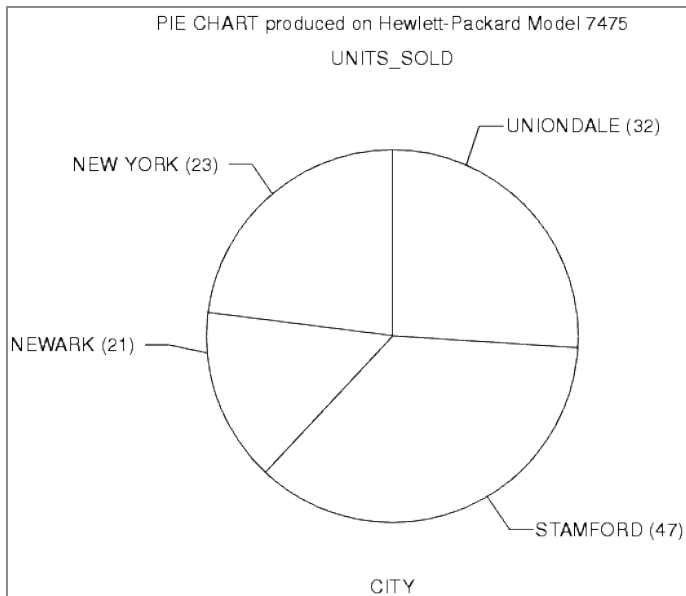

i Note: FOCUS does not include a facility for displaying exploded pie chart slices.

Scatter Diagrams

Scatter diagrams illustrate occurrence patterns and distribution of variables. Create them by issuing requests containing the verb PRINT and a sort phrase (BY or ACROSS). The choice of BY or ACROSS dictates the vertical or horizontal bias of the graph. The samples that follow illustrate both types.

```
GRAPH FILE SALES
HEADING CENTER
```

```
"SCATTER DIAGRAM USING ACROSS"
PRINT UNIT_SOLD ACROSS RETAIL_PRICE
END
```

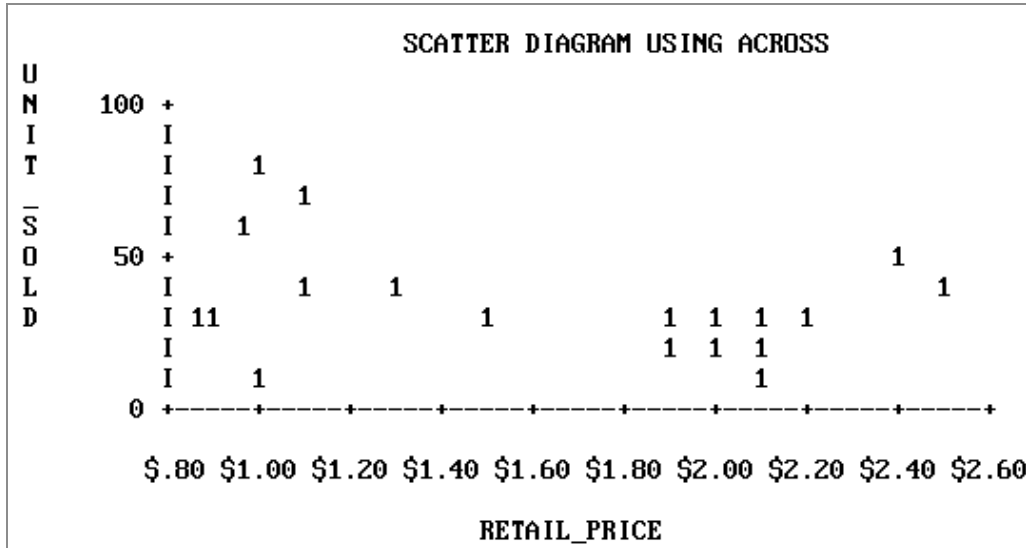

The point plots on the vertical axis represent the values for the ACROSS field named. Each record selected contributes a separate point. The sort control fields are plotted on the horizontal axis, which is also scaled if the control field values are numeric.

When the request contains a BY phrase, the named sort control field is plotted down the vertical axis and the data values are scaled horizontally.

```
GRAPH FILE SALES
HEADING CENTER
"SCATTER DIAGRAM USING BY"
PRINT UNIT_SOLD BY RETAIL_PRICE
END
```

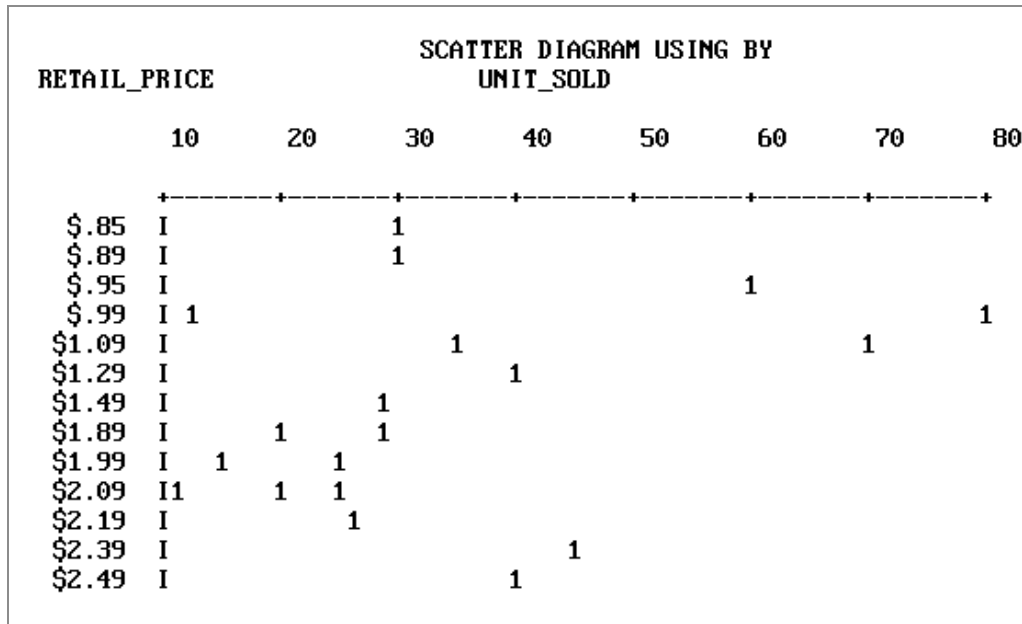
The vertical axis is not scaled even if the control field is numeric. Each separate value of the control field is plotted on a different line, but these are not arranged according to a numerical scale. The full range of horizontal scaling options is available (see [The Horizontal Axis: System Defaults](#)).

Scatter Diagram Features

When multiple points fall in the same position, FOCUS displays either a number (for up to nine occurrences) or an asterisk (for more than nine occurrences).

When you specify more than one verb object (five are permitted), they are represented by the first letter of the field name. If they are not different, you can assign unique symbols with AS phrases.

Scatter diagrams can display the following:

- Trend lines (available only in plots generated using ACROSS). Trend lines are calculated by Ordinary Least Squares (OLS) regression analysis and represent the line of best fit. You can add them to requests containing ACROSS phrases by setting the parameter GTREND before executing or replotting the request:

```
SET GTREND=ON
```

When two fields are plotted with GTREND=ON, FOCUS provides two trend lines. If more than two fields are plotted, however, FOCUS does not provide trend lines.

- Horizontal grids. You can add horizontal grid lines at the vertical class marks by setting the parameter GRID:

```
SET GRID=ON
```

- Vertical grids (available only in plots generated by requests using BY). You can add vertical parallel lines at the horizontal class marks of the scatter plot by setting the parameter VGRID:

```
SET VGRID=ON
```

Adjusting Graph Elements

All graphs other than pie charts have horizontal and vertical axes. These axes usually have scales with adjustable upper and lower thresholds that are divided into class intervals representing quantities of data (scales are only provided when the variables named are computational fields). Class intervals are further broken down with tick marks representing smaller increments of data.

When multiple graphs are created in a single request, FOCUS determines the default horizontal scale after examining all values to be plotted, and the same scale is then applied to each graph. Vertical scales are recalculated each time, however, and adjusted for the values in each graph (unless you override this feature).

Some graph forms, notably connected point plots, histograms, and bar charts, can be visually strengthened by adding parallel lines across the horizontal and/or vertical axes, to form a grid against which the data is arrayed.

The following describes the default conditions for all of these graph features, and the facilities for changing the default values to create customized output.

At any time during your session, you can review the current GRAPH parameter settings by typing:

```
? SET GRAPH
```

which displays the current settings of all of the adjustable GRAPH parameters, as shown below.

Parameter	Setting
DEVICE	IBM3270
GPROMPT	OFF
GRID	OFF
VGRID	OFF
HAXIS	130
VAXIS	66
GTREND	OFF
GRIBBON (GCOLOR)	OFF
VZERO	OFF
VAUTO	ON

Parameter	Setting
VMAX	.00
VMIN	.00
HAUTO	ON
HMAX	.00
HMIN	.00
AUTOTICK	ON
HTICK	.00
HCLASS	.00
VTICK	.00
VCLASS	.00
BARWIDTH	1

Parameter	Setting
BARSPACE	0
BARNUMB	OFF
HISTOGRAM	ON
HSTACK	OFF
BSTACK	OFF
PIE	OFF
GMISSING	OFF
GMISSVAL	.00

For information about each of the parameters listed, refer to [Command and SET Parameter Summary](#).

The Horizontal Axis: System Defaults

The width of each graph, including any surrounding text, is controlled by the HAXIS parameter. For online displays, FOCUS automatically detects the terminal width and plots the graph accordingly.

For graphs generated OFFLINE, the default value for HAXIS is normally set to the maximum possible size for the output device selected, after allowing for the inclusion of any text

required for the vertical axis and its labels along the left margin. To maximize display space, you can limit the size of your labels through the use of either AS phrases or DECODE expressions.

In setting the scale (when AUTOTICK=ON, and HAUTO=ON), FOCUS determines the amount of available space and the range of values selected for plotting. It then selects minimum, intermediate, and maximum unit values for the horizontal axis scale that encompass the range of values and are convenient multiples of an appropriate power of 10 (10 vs. 1000 vs. 1,000,000).

When you select a high-resolution graphic device, FOCUS controls the axis dimensions according to the values shown for the various devices in [Command and SET Parameter Summary](#).

Set the Width

To set the width of the graph to a given number of characters, issue the SET statement

```
SET HAXIS=nn
```

where:

nn

Is a numeric value between 20 and 130.

Set the Scale: Assigning Fixed Limits

FOCUS automatically sets the horizontal scale to cover the total range of values to be plotted (HAUTO=ON). The range is divided into intervals called classes. The scale is normalized to provide class values rounded to the appropriate multiples and powers of 10 for the intervals plotted on the axis.

If you wish to assign fixed upper and lower limits (useful when producing a series of graphs where consistent scales are needed), turn off the automatic scaling mechanism, and set new limit values. This is done with the SET command. The syntax is:

```
SET HAUTO=OFF, HMAX=nn, HMIN=nn
```

where:

HAUTO

Is the automatic scaling facility.

HMAX

Is the parameter for setting the upper limit on the horizontal axis. The default is 0.

HMIN

Is the parameter that controls the lower limit on the horizontal axis when HAUTO is OFF. The default is 0.

nn

Is the new limit.



Note:

- When entering several SET parameters on one line, separate them with commas.
- If you define limits that do not incorporate all of the data values, FOCUS displays OVER and/or UNDER to indicate that some of the data extracted is not reflected on the graph.

Set Class and Tick Intervals

Class intervals are the intervals between the labels and grid lines on a graph. Tick intervals are the subdivisions of class intervals. When AUTOTICK is ON, FOCUS automatically determines the class and tick intervals.

To set the class and tick intervals yourself, first turn off the default scaling mechanism, then reset the class and tick intervals with the SET command

```
SET AUTOTICK=OFF, HCLASS=nn, HTICK=nn
```

where:

AUTOTICK

Is the automatic scaling mechanism.

HCLASS

Is the parameter that controls the class interval on the horizontal axis when AUTOTICK is OFF. The default is 0.

nn

Is the new class interval value for the axis.

HTICK

Is the parameter that controls the tick interval when AUTOTICK is OFF. The default is 0.

nn

Is the new tick interval for the axis.



Note:

- When issuing more than one parameter with a sample SET command, separate parameters with commas as shown above.
- To make the changes apparent on the screen, SET SCREEN to PAPER.
- The number of ticks per class is HCLASS/HTICK.

The Vertical Axis: System Defaults

The vertical axis (VAXIS) represents the number of lines in the graph, including any surrounding text.

For online displays, FOCUS automatically plots the graph according to the terminal height. For graphs generated offline, FOCUS respects VAXIS settings.

FOCUS automatically sets the vertical scale to cover the total range of values to be plotted (VAUTO=ON). The height is set as high as possible, taking into consideration any headings and/or footings, and the need to provide suitably rounded vertical class markers.

The range is divided into intervals called classes. The scale is normalized to provide class values rounded to the appropriate multiples and powers of 10 for the intervals plotted on the axis.

As with the horizontal axis, FOCUS selects the vertical axis size whenever you select a high-resolution graphic device (see [Command and SET Parameter Summary](#)).

Set the Height

Use the following SET command to set the vertical axis:

```
SET VAXIS=nn
```

where:

nn

Is a number in the range 20-66.

Set the Scale: Assigning Fixed Limits

If you wish to give the vertical scale fixed upper and lower limits (useful when producing a series of graphs where consistent scales are needed), turn off the automatic scaling mechanism, and set fixed limits. This is done with the SET command:

```
SET VAUTO=OFF, VMAX=nn, VMIN=nn
```

where:

VAUTO

Is the automatic scaling facility.

VMAX

Is the parameter for setting the upper limit on the vertical axis. The default is 0.

VMIN

Is the parameter that controls the lower limit on the vertical axis when VAUTO is OFF. The default is 0.

nn

Is the new limit.

i Note:

- When entering several SET parameters on one line, separate them with commas.
- If you define limits that do not incorporate all of the data values, FOCUS displays OVER and/or UNDER to indicate that some of the data extracted is not reflected on the graph.

Set Class and Tick Intervals

To set the class and tick intervals on the vertical axis, first turn off the default scaling mechanism, and then reset the class and tick intervals with the SET command:

```
SET AUTOTICK=OFF, VCLASS=nn, VTICK=nn
```

where:

AUTOTICK

Is the automatic scaling mechanism.

VCLASS

Is the parameter that controls the class interval on the vertical axis when AUTOTICK is OFF. The default is 0.

nn

Is the new class interval for the vertical axis.

VTICK

Is the parameter that controls the tick interval when AUTOTICK is OFF. The default is 0.

nn

Is the new tick interval for the axis.

**Note:**

- When setting more than one parameter, separate them with commas.
- To make the changes apparent on screen, SET SCREEN to PAPER.
- The number of ticks per class is VCLASS/VTICK.

Highlighting Facilities

FOCUS contains the following facilities for highlighting the information shown on your graphs:

- Grid lines can be added on one or both axes of connected point plots and scatter diagrams, or the horizontal axis of histograms.
- Trend lines are usually included on most scatter plots.
- Summary numbers can be printed for each slice of a pie chart, or bar on a bar chart.

Add Horizontal or Vertical Grids

Grids often make graphs easier to read. They are parallel lines drawn across the graph at the vertical and/or horizontal class marks on the axes.

Horizontal grid lines are available on connected point plots, histograms, and scatter diagrams. To add them at the vertical class marks on your graph, issue the following:

```
SET GRID=ON
```

Vertical grid lines are available only on high-resolution devices in requests for connected point plots and scatter diagrams, and only when the values on both axes are numeric. To add them at the horizontal class marks on the graph, issue the following:

```
SET VGRID=ON
```

To remove the lines, set the appropriate parameter OFF.

Add Summary Numbers in Pie and Bar Charts

To print a summary number at the end of each bar on a bar chart or in each slice of a pie chart, set the parameter BARNUMB:

```
SET BARNUMB=ON
```

These summary numbers are not available on histograms.

Add Trend Lines on Scatter Plots

Trend lines are useful on scatter plots to give a focus to the sometimes confusing array of plot points. The trend line represents the notion of the "best fit" calculated by Ordinary Least Squares (OLS) regression analysis.

When two data fields are scattered across the same horizontal axis, each is given its own trend line. On some terminals with two-color ribbons, the lines are differentiated by color.

The system always requests a value for the parameter GTREND, whenever a scatter diagram is requested (the default value for GTREND is OFF). To request a trend line, set GTREND on:

```
SET GTREND=ON
```

Special Topics

The following topics have general applicability for many graph applications:

- How does FOCUS handle dates in graphs?
- How is missing data handled?
- Is it possible to save formatted graphic output and display it later?
- Is it possible to send graphs to a Personal Computer for display?
- What is the nature of the interface between FOCUS and CA-TELLAGRAF?
- What is the nature of the interface between FOCUS and ICU (Interactive Chart

Utility)?

These are described in the following sections.

Plotting Dates

Numerical fields containing dates are recognized by FOCUS through the formats in their Master Files. Such fields are interpreted by FOCUS if you name them in ACROSS or BY phrases in GRAPH requests. To review the various format types, see the *Describing Data* manual.

When plotting dates, FOCUS handles them in the following manner:

- If the date field named has a month format, it is plotted in ascending time order (even though the file is not sorted in ascending date order). Hence, month/year values of 01/76, 03/76, 09/75 are plotted by month within year: 09/75, 01/76, 03/76.
- Axis scaling is performed on the basis of days in the month and months in the year. When the date format includes the day, the scale usually starts at the first day of the month as the zero axis point.

You may wish to selectively combine groups of date point plots to reduce the number of separate points on the horizontal axis. Do this with the IN-GROUPS-OF option. For example, if the date field format is I6YMD, you can display the data by month rather than by day by grouping it in 30-day increments:

```
ACROSS DATE IN-GROUPS-OF 30
```

This eliminates plot points for individual days. If your date format is in a legacy YMD format you could also redefine the format and divide the field contents by 100 to eliminate the days:

```
DATE/I4YM=DATE/100
```

The example that follows illustrates a graph with date plots. Run it as an offline request:

```
SET HISTOGRAM=OFF
SET AUTOTICK=OFF, VCLASS = 200, VTICK = 25
DEFINE FILE SALES
SALES/D8.2=RETAIL_PRICE * UNIT_SOLD;
```

```

END
GRAPH FILE SALES
HEADING
"</6 <22 SAMPLE OF THE"
"<24 GRAPH DATE FACILITIES"
SUM SALES AND UNIT_SOLD ACROSS DATE
END

```

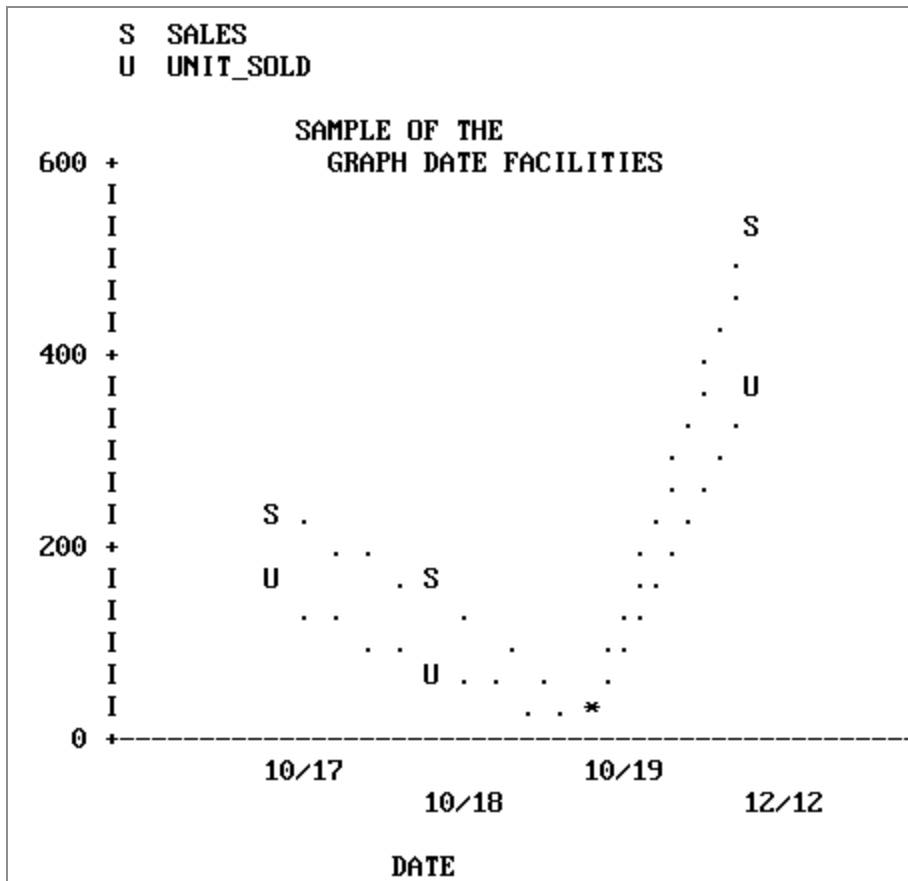

Handling Missing Data

You can handle missing data selectively in GRAPH requests. You can portray the missing data as null values, or choose to ignore missing values and have the plot span the missing points. This applies to requests containing both ACROSS and BY phrases, where the ACROSS values are plotted across the horizontal axis.

Normally, missing values on the vertical axis are ignored (VZERO=OFF). If ON, the values are treated as zero (0).

Instruct the system to ignore missing values through the SET options, GMISSING and GMISSVAL, or you can set GPROMPT=ON, and select the processing of the missing values when you execute your request. These SET operations can be done once for your entire session, or may be done on an individual basis to refine a particular request. Keep in mind that they remain in effect until you reset the parameters (see [Command and SET Parameter Summary](#)).

The examples that follow illustrate the same request, but with different treatments of missing values selected. Run them as offline requests:

```
SET GMISSING=ON, HIST=OFF
SET AUTOTICK=OFF, VCLASS=5, VTICK=1
GRAPH FILE SALES
HEADING
"</1 <22 SAMPLE OF"
"<24 THE GRAPH "
"<26 FACILITIES FOR"
"<28 MISSING DATA"
SUM RETURNS AND DAMAGED ACROSS PROD_CODE
END
```

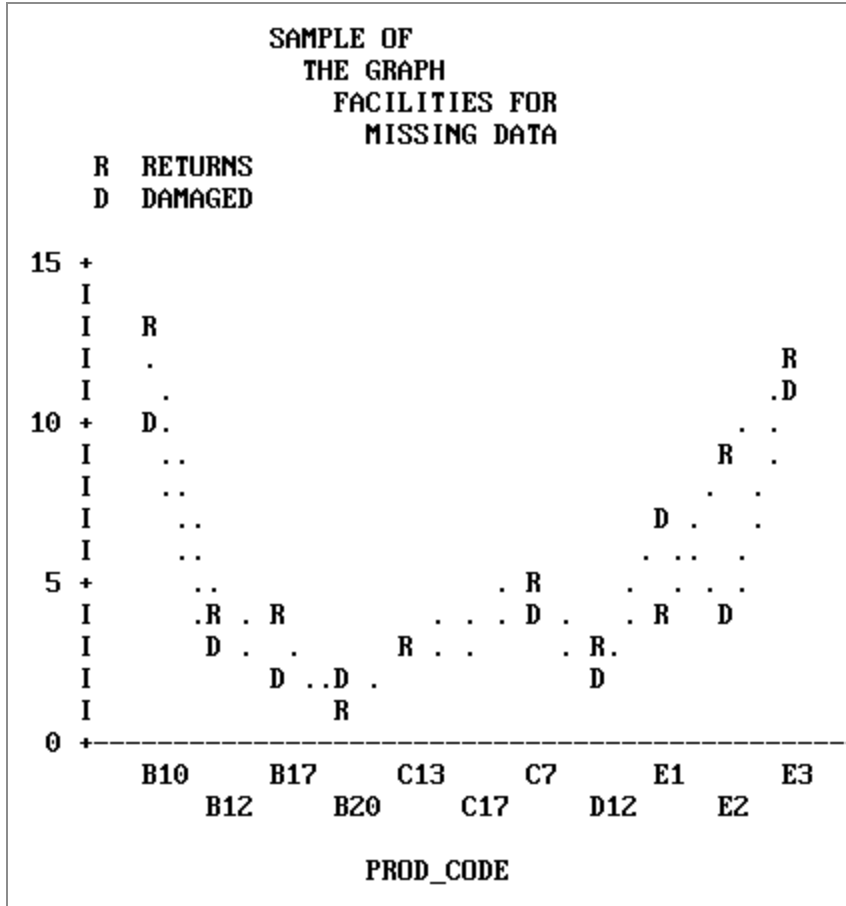

In this example GMISSING is ON and GMISSVAL is 0, so the graph ignores zero values for products C13 and C17.

The graph below shows the effect of changing the GMISSING parameter to OFF.

```
SET GMISSING=OFF
```

```
REPLOTT
```

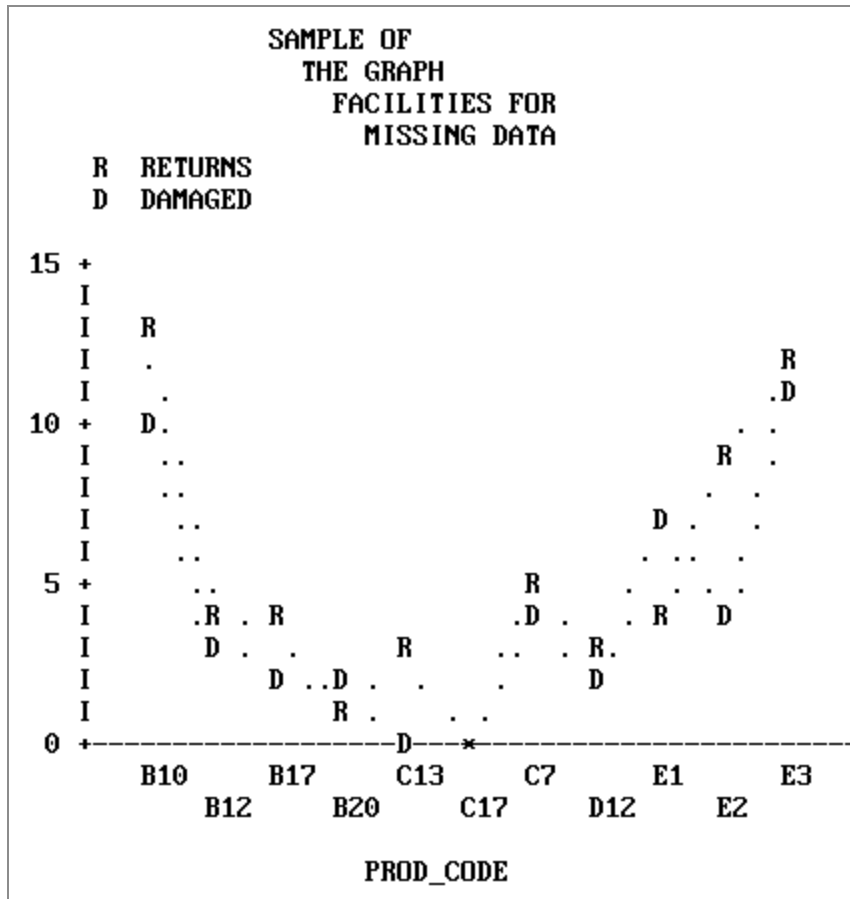
The values for products C13 and C17 were shown as positive values with GMISSING ON. With GMISSING=OFF, the zero values for products C13 and C17 are plotted on the graph.

Using Fixed-Axis Scales

When creating a series of graphs it is often desirable to have the same horizontal and vertical scales used for each graph in the group. This situation arises whenever your graph request combines an ACROSS phrase with a BY phrase.

In such requests the ACROSS values are plotted across the horizontal axis, and a separate graph is created for each value of the BY field. The default scales for the graphs vary depending on the range of values for each verb object and BY field combination.

To apply the same scale to each graph, turn off the default scaling mechanisms, and define your own minimum and maximum values for the axis thresholds. See [The Horizontal Axis: System Defaults](#), and [Set the Scale: Assigning Fixed Limits](#).

Saving Formatted GRAPH Output

You can place the output from GRAPH commands into specially formatted SAVE files for subsequent conversion into printed or displayed graphs. This capability, called deferred output, is useful for developing graph requests on a device other than the one you use to produce the final graph.

The facility described below is available for all ASCII graphics devices that FOCUS supports, but is not available for the IBM 3279 color graphics terminal, which has a separate GDDM facility for this purpose (see [IBM Devices Using GDDM](#)). In addition, deferred output cannot be generated from a CONSOLE.

The syntax for the FOCUS facility is:

```
GRAPH FILE ...
SUM ...
.
.
.
ON {GRAPH|TABLE} SAVE [AS savename] FORMAT GRAPH
ON {GRAPH|TABLE} SET parameter value [, parameter value...]
END
```

where:

ON GRAPH|ON TABLE

Denotes the command environment from which the request is entered. This syntax suppresses display of the output and returns a message that the file has been saved.

SAVE|SET

Is the action taken.

AS savename

Is an optional parameter that allows you to assign a permanent file name as the target for the formatted output. The default is FOCSAVE.

parameter value

Is the system value you want to change or set. Any parameter discussed in the *Developing Applications* manual can be set or changed here. The syntax is essentially the same as ON TABLE SET, which is discussed in Chapter 4, *Sorting Tabular Reports*.

FORMAT GRAPH

Specifies that the output is to be formatted for whatever graphics device is specified in the DEVICE parameter (see [Command and SET Parameter Summary](#)), and saved in either the SAVE file or a file you name in an AS phrase.

As an alternative, you can display a graph on the CONSOLE before creating a specially formatted SAVE file. To use this facility, enter a GRAPH request to generate a display, as shown below:

```
GRAPH FILE ...
SUM ...
.
.
.
END
```

After viewing the graph, use the following syntax to save the graph for later output on another device:

```
SAVE [AS savename] FORMAT GRAPH
```

Display Stored Graphs

To display stored graphs, issue the appropriate form of the REPLOT command from the output graphics DEVICE:

```
REPLOT [GRAPH|FROM] ddname
```

where:

REPLOT [GRAPH|FROM]

Is the function to be performed.

ddname

Is the SAVE file name. This must be provided even if the default FOCSAVE file was used.

i Note:

- You need not redefine the graphics device with another SET command. The device specified through the DEVICE= parameter when the graph was saved still applies.
- You can save the internal matrix produced for a request and issue a REPLOT later in the session if SAVEMATRIX is set to ON (see the *Developing Applications* manual).

You can allocate the file yourself through the appropriate operating system procedure, or you can let FOCUS allocate the SAVE file for you dynamically. If you allow FOCUS to allocate the file, it allocates a temporary file that you must rename if you wish to keep it after you log off.

The record layout of the graphics SAVE file is documented in Technical Memorandum #7704, *Description of Deferred Graphics Output* (available through your Information Builders Branch Office). You can process this file yourself if you have a deferred graph system that accepts low-level terminal graphics commands.

Creating Formatted Input for CA-TELLAGRAF

The Interface to CA-TELLAGRAF is a separate optional interface product that you use to create formatted FOCUS output files ready for processing by CA-TELLAGRAF, the publication-quality graphics system produced by Computer Associates. With it, you can write FOCUS GRAPH requests that generate files containing actual CA-TELLAGRAF commands and all of the necessary data and control information for producing graphs.

The data may originate in any FOCUS file or any file that FOCUS can read (for example, QSAM, VSAM, ISAM, IMS, CA-IDMS/DB, ADABAS, TOTAL, SQL, SYSTEM 2000, Model 204).

Directions for using the Interface can be found in the *TELLAGRAF Interface Users Manual*.

Using the FOCUS ICU Interface

The FOCUS ICU Interface is a separate optional interface product that you can use to generate graphs in conjunction with IBM's Interactive Chart Utility.

ICU displays graphs and provides menu selections which allow you to change such factors as graph type, size, and legend, and to send the graph to a printer.

The ICU Interface can place you directly in the ICU environment or can save the graph format and data for subsequent ICU processing. When you leave the ICU, control is returned to FOCUS.

All ICU graphics requests follow the standard FOCUS rules, and each of the default graphs is represented by an ICU format file distributed with FOCUS.

To use the ICU Interface, issue the command:

```
SET DEVICE = ICU
```

Subsequent GRAPH requests use ICU to generate graphs.

Directions for using this interface can be found in the *ICU Interface Users Manual*.

Special Graphics Devices

Graphs created with the FOCUS graphics generator can be printed or displayed in three levels of detail:

- Low-resolution graphs are produced by high-speed line printers and non-graphics terminals. Normally, this is adequate graphic information. While such graphs are not elegant, they are easily produced and allow you to preview graphic scenarios and refine the shapes and contents of your graphs. Subsequently, to create more "finished" versions you need only choose a different device or save the formatted output in a file to print later when a high-resolution device is available.
- Medium-resolution graphs are produced on devices such as Diablo, Trendata, and Anderson-Jacobson printers. These devices, which are driven by step motors, draw nearly continuous line plots, but the quality is not adequate for presentations.
- High-resolution graphic devices print continuous line plots, smooth curves, and create presentation-quality graphs. This category includes both devices created specifically for displaying graphics images (flat-bed and continuous line plotters, and color printers), as well as color CRTs. FOCUS supports three types of high-resolution graphics devices:
 - Hewlett-Packard four- and eight-pen plotters.

- IBM graphic CRTs and printers.
- Tektronix CRTs.

Medium-Resolution Devices

These devices use step motors to drive platens back and forth across the pages, to draw two series of spaced dots that simulate continuous lines. There are separate device symbols for the most frequently used printers (see DEVICE in [Command and SET Parameter Summary](#)), and a generic device code, HIGHRES (or HIGHRS12 for 12 pitch), for use with many unlisted printers.

Pie charts are not available on these devices.

When using this type of printer, set PAUSE=ON so that you can adjust the paper in the printer before drawing the graph.

High-Resolution Devices

This section describes the special considerations that apply when directing your FOCUS graphs to high-resolution devices from IBM, Hewlett-Packard, and Tektronix.

IBM Devices Using GDDM

To produce graphs on IBM graphics printers or high-resolution graphics terminals, you must have IBM's Graphical Data Display Manager (GDDM). GDDM provides various subroutines for saving, printing, and copying graphic screen contents. FOCUS produces graphs on IBM terminals or printers when you set DEVICE=IBM3279. See your IBM representative concerning the proper configuration for your device controller and terminal.

GDDM Default Conditions

Whenever graphs are created using FOCUS and GDDM, the printed form of the graph (activated by pressing the PF4 key) has a default size of 132 by 80 characters on 3284 or 3287 printers. These sizes are independent of the parameters that control the lengths of

the axes. As a default, each graph is presented with a frame (border). If you wish to omit the frame, set `FRAME=OFF`.

GDDM Save and Print Facilities

GDDM includes facilities for saving generated graphs; press the PF1 key to save graphs in an ADMSAVE file on your operating system. Thus saved, you can subsequently use the IBM program ADMUSF2 (supplied with GDDM) to display the saved screens.

For special instructions covering the positioning of graphs on IBM 3284 or 3287 printers, please refer to Technical Memorandum #7689, *Plot Table Settings* (available through your Information Builders Branch Office).

Graphics Device Characteristics

To draw vectors, use 7-color displays, or define your own special field patterns, you need a 3279 Model 2B, 3B, 3SG, or 3X with a 3274 terminal controller and C configuration support. C supports structured field and attribute processing (SFAP) and the use of programmed symbols (PS). The Model 3276 terminal controller does not use C.

3279 Models 2A and 3A have only Base Color, which automatically maps colors to preset 3270 field types:

- Protected intensified becomes white.
- Unprotected intensified becomes red.
- Protected normal intensity fields become blue.
- Unprotected normal intensity fields become green.

Thus, FIDEL is automatically color-coded with no programming changes, but only in Base Color. Additional colors are available with the 3SG, 3X and the older B models.

Hewlett-Packard Plotters

The Hewlett-Packard 7220 series plotters translate FOCUS graph requests into 4- or 8-color graphs, suitable for presentations. Color selections and assignments are made using the

standard Hewlett-Packard procedures. (Special pens are available from Hewlett-Packard for plotting graphs on transparencies for overhead projection.) For plotters with optional text facilities, FOCUS has special parameters for controlling:

- Text positioning (column, line, and spacing).
- Color pen selection (red, blue, green, black).
- Letter sizes (two or four times the default size).
- Special font selection (slanted text).

To activate Hewlett-Packard plotters, use the appropriate form of the SET TERM or DEVICE (see [Command and SET Parameter Summary](#)). FOCUS provides default lengths and scaling of axes, but these and the other graphic elements can be changed by adjusting SET parameters discussed in [Adjusting Graph Elements](#) and summarized in [Command and SET Parameter Summary](#).

Ordinarily, plotters are connected in line with a terminal and a modem. Thus, you can refine your graph requests, viewing the output on the terminal, until you produce exactly what you want and then set the DEVICE parameter to your plotter and issue the REPLOT command to produce the hard copy.

Use the plotter controls to position graphs anywhere on sheets of paper up to 11 by 16.5 inches. Unless you change the default paper size, FOCUS prepares output for an 8.5 by 11-inch sheet placed lengthwise in the lower left-hand corner of the plotter. The other default assignments are as follows:

```
HAXIS=130, VAXIS=66, GCOLOR=ON
```

Tektronix Color Terminals

Tektronix high-resolution CRTs can display the output from GRAPH requests, but only in black and white. The sizes of the vertical and horizontal axes are set depending on the device selected, and cannot be overridden. Select the appropriate device number from those listed in the [Command and SET Parameter Summary](#).

Command and SET Parameter Summary

The FOCUS GRAPH command plots data retrieved with request statements in the form of a graph, with horizontal and vertical axes. Many of the elements used in TABLE requests are used in exactly the same way in GRAPH requests.

The GRAPH environment also includes a set of parameters that control the look of the graph and offer additional control at run time (for example, pause to adjust paper before printing, select a device, etc.).

GRAPH Command

In the syntax samples that follow, the elements are the same as those used in TABLE requests. The complete set is shown here but the elements are described more fully in Chapter 4, *Sorting Tabular Reports*.

Enter the Environment

To enter the GRAPH environment, enter the following:

```
GRAPH FILE filename
```

Specify Annotating Text

Heading strings can contain any character except the double quotation mark ("), and can also contain field references and formatting controls.

Heading: This syntax is used to specify graph headings:

```
[HEADING [CENTER]]  
"string1"  
["string2"]
```

Field reference format: This syntax is used to specify field reference format:

```
<[prefix.]fieldname[>]
```

Formatting controls: The following formatting controls may be specified as part of a graph request:

```
Tab to column "n" . . . . .<n
Tab "n" columns to the right . . . .<+n
Tab "n" columns to the left . . . .<-n
Return to column 1
  and advance "n" lines. . . . .</n
Name a color for a line . . . . .<.color
Select special font
  [BIG, SLANT or BLOCK on HP7220]. .<.fontname
  ("BIG" doubles the character
   sizes, "BLOCK" quadruples them)
Reset controls to default settings <.CLEar
```

Name the Subject and Graph Type

The following syntax is used to specify the subject and graph type:

```
commandobject1 [[AND|OVER] object2...object5]
```

where:

command

Is one of the following: PRINT, WRITE, SUM, ADD or COUNT.

Specify Display Fields

Display fields can be any of the following:

```
[prefix.]fieldname [AS 'string'] [IN position]
COMPUTE name1 [/format1] = expression1;[AS 'string1']
COMPUTE name2 [/format2] = expression2;[AS 'string2']
```

Specify Horizontal Sorting of Data Points

The following syntax is used for horizontal sorting of data:

```
ACROSS fieldname [IN-GROUPS-OF n [TOP]][AS 'string']  
ACROSS fieldname [IN position]
```

Specify Separate Graphs or Vertical Sorting of Plot Points

The following syntax is used:

```
BY fieldname [IN-GROUPS-OF n [TOP]][AS 'string']
```

Save the Formatted Graph Data in a File

The following syntax is used:

```
ON [GRAPH] SAVE [AS filename] FORMAT GRAPH
```

Complete the GRAPH Request

To complete a graph request, type the command END on a separate line:

```
END
```

If you do not wish to complete the graph request, use one of the following methods to abort the request and return to FOCUS:

- To quit in the middle of a graph request, type the command QUIT on a separate line:

```
QUIT
```

- To terminate the display of a graph, type the command HT from the command line:

```
HT
```

Concatenate Unlike Data Sources

To concatenate unlike data sources in a single graph request, divide your request into one main request that retrieves the first file, and a subrequest for each concatenated file. The main request defines the data fields, sorting criteria, and output format for each file. The MORE command concatenates each file after the first. The syntax is:

```
GRAPH FILE file1
main request
MORE
FILE file2
subrequest
MORE
.
.
.
END
```



Note: IF and WHERE selection tests apply only to the subrequest in which they appear.

SET Parameters

To set the parameters that control the GRAPH environment, use the appropriate variation of the SET command. The syntax is as follows:

```
SET parameter=value,parameter=value...
```

For example:

```
SET HAXIS=75,VAXIS=40
SET GRID=OFF,BARSPACE=2,BARWIDTH=3
```

i Note:

- Repeat the command SET on each new line.
- When entering more than one parameter on a line, separate them with commas.
- You can use unique truncations of parameter names. Make sure, however, that they are unique.

To review the current parameter settings, issue the command:

```
? SET GRAPH
```

which produces a listing of the values.

The table that follows lists all of the parameters in alphabetic sequence, showing the name, range of values (default is underlined), and function of each.

Parameter Name	Range of Values	Parameter Function
AUTOTICK	ON/OFF	When ON, FOCUS automatically sets the tick mark intervals. (See also HTICK and VTICK.)
BARNUMB	ON/OFF	Places the summary values at the ends of the bars on bar charts, or slices on pie charts.
BARSPACE	0- <u>32767</u>	Specifies the number of lines separating the bars on bar charts.
BARWIDTH	1- <u>32767</u>	Specifies the number of lines per bar on bar charts.

Parameter Name	Range of Values	Parameter Function
BSTACK	ON/OFF	Specifies that the bars on a bar chart are to be stacked rather than placed side by side.
DEVICE or TERMINAL	IBM3270	Specifies the plotting device or terminal to be used. When the default is used, low-resolution graphics are sent to your terminal or to the printer if PRINT=OFFLINE (see the SET command in the <i>Developing Applications</i> manual). Medium- and high-resolution devices are selected by entering one of the following parameter settings for the DEVICE (or TERMINAL).
Medium-resolution devices:		
	AJ	Specifies Anderson Jacobson - Model AJ830.
	AJ12	Specifies Anderson Jacobson - Model AJ832 (12 Pitch).
	DIABLO	Specifies Diablo - Model 1620.
	DIABLO12	Specifies Diablo - Model 1620 (12 Pitch).
	GS	Specifies Gencom.
	GS12	Specifies Gencom (12 Pitch).

Parameter Name	Range of Values	Parameter Function
	HIGHRES	Specifies a generic device for most medium-resolution graphic devices.
	HIGHRS12	Specifies a generic device -see above (12 Pitch).
	TRENDATA	Specifies Trendata - Model 4000A.
	TRENDT12	Specifies Trendata - Model 4000A (12 Pitch).
High-resolution devices from Hewlett-Packard:		
	HP7220	Specifies HP Models 7229A and 7470A. Both are 4-pen plotters with no paper advance. Model 7470 requires a special Y cable (Part #17455).
	HP7220S	Specifies HP Model 7220S, 4-pen plotter with paper advance.
	HP7220C	Specifies HP Models 7220C and 7475A. Both are 8-pen plotters with no paper advance. Model 7475 requires a special Y cable (Part #17455).
	HP7220T	Specifies HP Model 7220T, 8-pen plotter with paper advance.
	HP7221	Specifies HP Model 7221, 4-pen plotter with no paper advance.

Parameter Name	Range of Values	Parameter Function
	HP7221S	Specifies HP Model 7221S, 4-pen plotter with paper advance.
	HP7221C	Specifies HP Model 7221C, 8-pen plotter with no paper advance.
	HP7221T	Specifies HP Model 7221T, 8-pen plotter with paper advance.

i Note: The default horizontal and vertical axes for all Hewlett-Packard devices are as follows:

HAXIS=100, VAXIS=50.

Parameter Name	Range of Values	Parameter Function
High-resolution devices from IBM:		
	IBM3279	<p>Specifies one of the following devices:</p> <p>Any IBM 3270 series device that supports GDDM graphics, such as the 3279-S3G, 3179, or 3472. This includes PCs with fully compatible 3270 series hardware and software.</p> <p>Printers: Any IBM 3270 series printer that supports GDDM graphics, such as the 3287-2C and the 4224.</p>

i Note: IBM's Graphical Data Display Manager (GDDM) is required for all of these devices. Entering this value automatically sets the following GRAPH parameter values: HAXIS=80, VAXIS=32, and GCOLOR=ON. For any monochrome device, you should set GCOLOR=OFF; for any Model 2 device (24x80 screen), you should set VAXIS=-24.

Parameter Name	Range of Values	Parameter Function
High-resolution devices from Tektronix:		
	TEK4010	Specifies one of the following models: 4010, 4050 series and 4100 series (B/W only). Automatically sets HAXIS=74, VAXIS=35, and GCOLOR=OFF.
	TEK4012	Specifies Model 4012. Automatically sets HAXIS=74, VAXIS=35, and GCOLOR=OFF.
	TEK4013	Specifies Model 4013. Automatically sets HAXIS=74, VAXIS=35, and GCOLOR=OFF.
	TEK4014	Specifies Model 4014. Automatically sets HAXIS=133, VAXIS=64, and GCOLOR=OFF.
	TEK4014E	Specifies Model 4014E. Automatically sets HAXIS=133, VAXIS=64, and GCOLOR=OFF.
	TEK4015	Specifies Model 4015. Automatically sets HAXIS=74, VAXIS=35, and GCOLOR=OFF.
	TEK4015E	Specifies Model 4015E. Automatically sets HAXIS=74, VAXIS=35, and GCOLOR=OFF.
	TEK4025	Specifies Model 4025. Automatically sets HAXIS=80, VAXIS=32, and GCOLOR=OFF.

Parameter Name	Range of Values	Parameter Function
	TEK4027	Specifies Model 4027. Automatically sets HAXIS=80, VAXIS=32, and GCOLOR=ON.
	TEK4662	Specifies Model 4662. Plot address is D. It is recommended that you set GCOLOR=OFF, HAXIS=80, VAXIS=32. If the Model 4662 is connected to a Model 4025, set DEVICE=TEK4025. If the Model 4662 is connected to a Model 4027, set DEVICE=TEK4027.

Parameter Name	Range of Values	Parameter Function
FRAME	ON/OFF	For GDDM graphics, ON (the default) indicates you want a frame around your graph. To omit the Frame, set OFF.
GCOLOR (or GRIBBON)	ON/OFF	On medium- and high-resolution devices, setting this parameter OFF causes different black and white patterns to be substituted for colors. On medium-resolution devices, setting it ON causes alternation between black and red ribbons on multiline plots. Note: 3287 printers use black, red, blue, and green.
GMISSING	ON/OFF	If ON, specifies that variables with the value specified in GMISSVAL are to be ignored.
GMISSVAL	nn	Specifies the variable value that represents missing data.
G_PROMPT	ON/OFF	When ON, FOCUS prompts for all pertinent graph parameters.

Parameter Name	Range of Values	Parameter Function
GRIBBON		See GCOLOR.
GRID	ON/OFF	When ON, specifies that a grid of parallel horizontal lines is to be drawn on the graph at the vertical class marks (see also VGRID).
GTREND	ON/OFF	When ON, specifies that a trend line is to appear on scatter diagrams.
HAUTO	ON/OFF	Specifies automatic scaling of the horizontal axis unless overridden by the user. If OFF, the user must supply values for HMAX and HMIN.
HAXIS	20-130	Specifies the width in characters of the horizontal axis. This parameter can be adjusted for graphs generated OFFLINE. HAXIS is ignored for ONLINE displays, since FOCUS automatically adjusts the width of the graph to the width of the terminal.
HCLASS	nnn	Specifies the horizontal class interval when AUTOTICK=OFF.
HISTOGRAM	ON/OFF	When ON, FOCUS draws a histogram instead of a curve when values on the horizontal axis are not numeric.
HMAX	nnn	Specifies the maximum value on the horizontal axis when automatic scaling is not used (HAUTO=OFF).

Parameter Name	Range of Values	Parameter Function
HMIN	nnn	Specifies the minimum value on the horizontal axis when automatic scaling is not used (HAUTO=OFF).
HSTACK	ON/OFF	Specifies that the bars on a histogram are to be stacked rather than placed side by side.
HTICK	nnn	Specifies the horizontal axis tick mark interval, when AUTOTICK is OFF.
PAUSE	ON/OFF	Specifies whether there is a pause for paper adjustment on the plotter after the request is executed.
PIE	ON/OFF	Specifies a pie chart is desired (only available on high-resolution devices).
PLOT		<p>Specifies the width and height settings for a graphic printer if DEVICE=IBM3279 or HIGHRES. Hexadecimal values must be supplied. For example:</p> <pre>SET PLOT=0050,0018</pre> <p>produces a printed plot of 80 by 24 decimal characters (50 hex = 80 decimal, 18 hex = 24 decimal).</p> <p>When used, the PLOT parameter must be the last parameter set.</p>
PRINT	ONLINE /OFFLINE	When OFFLINE is entered, the graph is printed on the system high-speed printer.

Parameter Name	Range of Values	Parameter Function
TERM		See DEVICE.
VAUTO	ON/OFF	Specifies automatic scaling of the vertical axis unless overridden by the user. If OFF, the user must supply values for VMAX and VMIN.
VAXIS	20-66	Page length in lines. This parameter can be adjusted for graphs generated OFFLINE. VAXIS is ignored for ONLINE displays, since FOCUS automatically adjusts the height of the graph to the height of the terminal.
VCLASS	nnn	Specifies the vertical class interval when AUTOTICK=OFF.
VGRID	ON/OFF	When ON, specifies that a grid of parallel vertical lines is to be drawn on the graph at the horizontal class marks (see also GRID).
VMAX	nnn	Specifies the maximum value on the vertical axis when automatic scaling is not used (VAUTO=OFF).
VMIN	nnn	Specifies the minimum value on the vertical axis when automatic scaling is not used (VAUTO=OFF).
VTICK	nnn	Specifies the vertical axis tick mark interval, when AUTOTICK is OFF.
VZERO	ON/OFF	With VZERO=OFF, missing values on the vertical axis are ignored. If ON, the values are treated as zero (0).

Using SQL to Create Reports

SQL users can issue report requests that combine SQL statements with TABLE formatting phrases to take advantage of a wide range of report preparation options.

These combined requests are supported through the SQL Translator, which converts ANSI Level 2 SQL statements into executable FOCUS requests.

You can use the SQL Translator to retrieve and analyze FOCUS and DBMS data.

Supported and Unsupported SQL Statements

SQL Translation Services are compliant with ANSI Level 2. This facility supports many, but not all, SQL statements. RDBMS engines may also support the *alpha1* CONCAT *alpha2* syntax. See [Supported and Unsupported SQL Statements](#) and [Supported and Unsupported SQL Statements](#).

i Note: Because the SQL Translator is ANSI Level 2 compliant, some requests that worked in prior releases may no longer work.

Supported SQL Statements

SQL Translation Services support the following:

- SELECT, including SELECT ALL and SELECT DISTINCT.
- CREATE TABLE. The following data types are supported for CREATE TABLE: REAL, DOUBLE PRECISION, FLOAT, INTEGER, DECIMAL, CHARACTER, SMALLINT, DATE, TIME, and TIMESTAMP.
- INSERT, UPDATE, and DELETE for relational, IMS, and FOCUS data sources.
- Equijoins and non-equijoins.
- Outer joins are subject to certain restrictions. See [Using SQL Translator Commands](#).

- CREATE VIEW and DROP VIEW.
- PREPARE and EXECUTE.
- Delimited identifiers of table names and column names. Table and column names containing embedded blanks or other special characters in the SELECT list should be enclosed in double quotation marks.
- Column names qualified by table names or by table tags.
- The UNION [ALL], INTERSECT [ALL], and EXCEPT [ALL] operators.
- Non-correlated subqueries for all requests in the WHERE predicate and in the FROM list.
- Correlated subqueries for requests that are candidates for Dialect Translation to an RDBMS that supports this feature. Note that correlated subqueries are not supported for FOCUS and other non-relational data sources.
- Numeric constants, literals, and expressions in the SELECT list.
- Scalar functions for queries that are candidates for Dialect Translation if the RDBMS engine supports the scalar function type. These include: ABS, CHAR, CHAR_LENGTH, CONCAT, COUNTBY, DATE, DAY, DAYS, DECIMAL, EDIT, EXTRACT, FLOAT, HOUR, IF, INT, INTEGER, LCASE, LENGTH, LOG, LTRIM, MICROSECOND, MILLISECOND, MINUTE, MONTH, POSITION, RTRIM, SECOND, SQRT, SUBSTR (or SUBSTRING), TIME, TIMESTAMP, TRIM, VALUE, UCASE, and YEAR.

Note that the following functions are not supported by FOCUS for Mainframe: DIGITS, HEX, VARGRAPHIC.

- The concatenation operator, '||', used with literals or alphanumeric columns.
- The following aggregate functions: COUNT, MIN, MAX, SUM, and AVG.
- The following expressions can appear the conditions: CASE, NULLIF, and COALESCE.
- Date, time, and timestamp literals of several different formats. See [SQL Translator Support for Date, Time, and Timestamp Fields](#).
- All requests that contain ANY, SOME, and ALL that do not contain =ALL, <>ANY, and <>SOME.
- =ALL, <>ANY, and <>SOME for requests that are candidates for Dialect Translation if the RDBMS engine supports quantified subqueries.
- The special registers USER, CURRENT_DATE, CURRENT_TIME, CURRENT_TIMESTAMP,

CURRENT_EDASQLVERSION, and CURRENT_TIMEZONE.

- NULL and NOT NULL predicates.
- LIKE and NOT LIKE predicates.
- IN and NOT IN predicates.
- Date and time arithmetic.
- EXISTS and NOT EXISTS predicates.
- GROUP BY clauses expressed using explicit column names, AS names, or column positions.
- ORDER BY clauses expressed using explicit column names or column numbers.
- FOR FETCH ONLY feature to circumvent record locking.
- Continental Decimal Notation (CDN) when the CDN variable is set.
- National Language Support (NLS).

Unsupported SQL Statements

SQL Translation Services do not support the following:

- More than 15 joins per SELECT. This limit is set by SQL. FOCUS supports up to 16 joins.
- ALIAS names in Master Files and the use of formatting options to format output.
- Unique truncations of column names.
- Temporary defined columns. Permanent defined columns, defined in the Master File, are supported.
- Correlated subqueries for DML Generation.

SQL Translator Reserved Words

The following words may not be used as field names in a Master File that is used with the SQL Translator:

- ALL
- COUNT
- SUM
- MAX
- MIN
- AVG
- CURRENT
- DISTINCT
- USER

Using SQL Translator Commands

The SQL command may be used to report from any supported data source or set of data sources. Standard TABLE phrases for formatting reports can be appended to the SQL statements to take advantage of a wide range of report preparation options.

i Note: If you need to join data sources for your request, you have two options: use the JOIN command before you issue any SQL statements, or use the WHERE predicate in the SQL SELECT statement to join the required files dynamically. See [Using SQL Translator Commands](#).

Use SQL Translator Commands

```
SQL  
sql statement;  
[ECHO|FILE]  
[TABLE phrases]  
END
```

where:

SQL

Is the SQL command identifier, which invokes the SQL Translator.

i Note: The SQL command components must appear in the order represented above.

sql statement

Is a supported SQL statement. The statement must be terminated by a semicolon (;). It can continue for more than one line. See [Supported and Unsupported SQL Statements](#).

Within the SQL statement, field names are limited to 48 characters (an ANSI standard Level 2 limitation). View names generated through the SQL CREATE VIEW statement are limited to 18 characters and subqueries can be nested up to 15 levels deep. Correlated subqueries are not supported by FOCUS and other non-relational data sources.

ECHO

Are optional debugging phrases that capture the generated TABLE request. These options are placed after the SQL statement.

FILE [name]

Writes the translated TABLE phrases to the named procedure. If you do not supply a file name, a default name is assigned when the request runs. The file is then deleted.

TABLE phrases

Are optional TABLE formatting phrases. See [Using SQL Translator Commands](#).

END or QUIT

Is required to terminate the procedure.

Using SQL Translator Commands

The following request contains an SQL statement and TABLE formatting commands:

```
SQL
SELECT BODYTYPE, AVG(MPG), SUM(SALES)
FROM CAR
WHERE RETAIL_COST > 5000
```

```
GROUP BY BODYTYPE;  
TABLE HEADING CENTER  
"AVERAGE MPG AND TOTAL SALES PER BODYTYPE"  
END
```

TABLE Formatting Phrases in SQL Requests

You can include TABLE-formatting phrases in an SQL request, subject to the following rules:

- Use TABLE formatting phrases with SELECT and UNION only.
- Introduce the formatting phrases with the word TABLE.
- You may specify headings and footings, describe actions with an ON phrase, or use the ON TABLE SET command. Additionally, you can use ON TABLE HOLD or ON TABLE PCHOLD to create an extract file. You can also specify READLIMIT and RECORDLIMIT tests.

For details on ON TABLE HOLD or ON TABLE PCHOLD, see [Saving and Reusing Your Report Output](#).

- You cannot specify additional display fields, ACROSS fields, WHERE or IF criteria (other than READLIMIT or RECORDLIMIT tests), or calculated values. BY phrases are ignored.

The SQL SELECT Statement

The SQL SELECT statement translates into one or more TABLE PRINT or TABLE SUM commands, depending on whether individual field display or aggregation is applied in the request. See [Displaying Report Data](#).

The SQL statement SELECT * translates to a PRINT of every field in the Master File, and uses all of the fields of the Cartesian product. This is a quick way to display a file, provided it fits in a reasonable number of screens for display, or provided you use ON TABLE HOLD or ON TABLE PCHOLD to retain retrieved data in a file for reuse. See [Saving and Reusing Your Report Output](#).

SQL functions (such as COUNT, SUM, MAX, MIN, AVG) are supported in SELECT lists and HAVING conditions. Expressions may be used as function arguments.

The function COUNT (*) translates to a count of the number of records produced by printing all fields in the Master File. This is the same as counting all rows in the Cartesian product that results from a SELECT on all fields.

Whenever possible, expressions in the SQL WHERE predicate are translated into corresponding WHERE criteria in the TABLE request. Expressions in SELECT lists generate virtual fields. The SQL HAVING clauses also translate into corresponding WHERE TOTAL criteria in the TABLE request. The SQL LIKE operator is translated directly into the corresponding LIKE operator in the WHERE criteria of the TABLE request. For details on record selection in TABLE requests, see [Selecting Records for Your Report](#).

Only subqueries based on equality, when the WHERE expression is compared to a subquery by using an equal (=) sign, are supported. For example: WHERE field = (SELECT ...).

The SQL UNION operator translates to a TABLE request that creates a HOLD file for each data source specified, followed by a MATCH command with option HOLD OLD-OR-NEW, which combines records from both the first (old) data source and the second (new) data source. See [Merging Data Sources](#).

For related information, see [Supported and Unsupported SQL Statements](#) and [Using SQL Translator Commands](#).

Using the SQL SELECT Statement Without a FROM Clause

SELECT without a FROM clause is supported for returning a one-row answer set consisting of one or more constant values. No Master File is needed for issuing this type of SELECT. One use for this syntax is to test functions. For example, the following SQL SELECT returns a literal value and the results of two function calls:

```
SQL
SELECT 'MOD' AS FUNCTION, MOD(6,3) AS MOD1, MOD(5,3) AS MOD2;
TABLE
ON TABLE SET PAGE NOLEAD
ON TABLE SET STYLE *
GRID=OFF,$
ENDSTYLE
END
```

The output is shown in the following image.

<u>FUNCTION</u>	<u>MOD1</u>	<u>MOD2</u>
MOD	0	2

SQL Joins

When performing SQL joins, the formats of the joined fields must be the same. Join fields need not be indexed, and non-equi joins are supported.

Recursive, outer, and inner joins are supported. Inner join is the default.

Create an Inner Join

Two syntax variations are supported for inner joins.

Variation 1

```
SQL
SELECT fieldlist FROM file1 [alias1], file2 [alias2]
[WHERE where_condition];
END
```

Variation 2

```
SQL
SELECT fieldlist FROM file1 [alias1] INNER JOIN file2 [alias2]
ON join_condition [INNER JOIN ...]
[WHERE where_condition];
END
```

where:

fieldlist

Identifies which fields are retrieved from which data sources.

Joined fields in the SQL WHERE predicate must be qualified if the names are not unique. Specify them with their corresponding file names or file aliases. For example:

```
{file1|alias1}.field1, {file2|alias2}.field2
```

FROM

Introduces the data sources to be joined.

file1, file2

Are the data sources to be joined.

alias1, alias2

Are optional alternate names for the data sources to be joined.

where_condition

Is an optional selection condition for the joined answer set. Joined rows that do not satisfy this condition are eliminated from the returned answer set. If omitted in Variation 1, the answer set is the Cartesian product of the two data sources.

join_condition

Is the join condition.

Create an Outer Join

```
SQL
SELECT fieldlist FROM file1 {LEFT|RIGHT|FULL} JOIN file2
ON join_condition [{LEFT|RIGHT|FULL} JOIN ...]
WHERE where_condition
END
```

where:

fieldlist

Identifies which fields are to be retrieved from which data sources.

Joined fields in the SQL WHERE predicate must be qualified if the names are not unique. Specify them with their corresponding file names or file aliases. For example:

```
{file1|alias1}.field1, {file2|alias2}.field2
```

FROM

Introduces the data sources to be joined.

file1, file2

Are the data sources to be joined.

alias1, alias2

Are optional alternate names for the data sources to be joined.

join_condition

Is the join condition. The condition must specify equality. For example, T1.A=T2.B.

where_condition

Is an optional selection condition for the joined answer set. Joined rows that do not satisfy this condition are eliminated from the returned answer set.

Join Name Assignments From the SQL Translator

Joins issued by the SQL Translator are assigned names in the format:

```
SQLJNMnn
```

where:

SQLJNM

Is the SQL Translator join prefix.

nn

Is a number between 01 and 16 assigned in the order in which the joins are created (FOCUS supports a maximum of 16 joins). The first join has the AS name SQLJNM01, the second join is named SQLJNM02, and so on, up to SQLJNM16.

All joins are automatically created and cleared by the SQL Translator. No user-specified joins are affected.

Using Qualified Field Names in SQL Joins

In the following statement, T.A and U.B are qualified field names:

```
SQL
SELECT T.A, T.B
FROM T, U
WHERE T.A = U.B;
END
```

Using Recursive SQL Joins

In the following statement, A and B are aliases for the same data source, CAR. The output from CAR is pairs of B values that have the same A values:

```
SQL
SELECT A.SEATS, B.SEATS
FROM CAR A, CAR B
WHERE A.MODEL = B.MODEL;
END
```

Note that all field names in the SELECT clause must be unique or qualified.

Using SQL Full Outer Joins

In the following statement, B, C, and D are aliases for different data sources:

```
SQL
SELECT
    B.FIELD1 AS B_FIELD1, B.FIELD2 AS B_FIELD2,
    D.FIELD1 AS D_FIELD1, D.FIELD2 AS D_FIELD2
FROM
    ((FILE1 B FULL OUTER JOIN FILE2 C ON B.FIELD2 = C.FIELD2 )
     FULL OUTER JOIN FILE3 D ON C.FIELD2 = D.FIELD2 )
WHERE B.FIELD1 < 2
END
```

Multiple FULL OUTER JOINS are supported. However, they generate from a few to many temporary HOLD files.

SQL Join Considerations

- In standard SQL, WHERE field='a' selects records where the field has the value 'a' or 'A'. The SQL Translator is case-sensitive and returns the exact value requested (in this case, 'a' only).
- The SQL comparison operators ANY, SOME, and ALL are supported, with the exception of =ALL, <>ANY, and <>SOME.
- Sub-selects are not supported in HAVING conditions.
- In a multi-segment structure, parent segments are omitted from reports if no instances of their descendant segments exist. This is an inner join.
- The SQL Translator applies optimization techniques when constructing joins. See [Index Optimized Retrieval](#).

SQL CREATE TABLE and INSERT INTO Commands

SQL Translator supports the commands CREATE TABLE and INSERT INTO table:

- CREATE TABLE creates a new data source table. It only generates single-segment Master Files.
- INSERT INTO inserts a row or block of rows into a table or view. Single-record insert with actual data values is supported.

These commands enable you to create tables to enhance reporting efficiency.

 **Note:** When applications are enabled, the Master File and data source are written to the APPHOLD directory. When applications are disabled, the Master File and data source are written to the TEMP directory.

Usage Notes for CREATE TABLE and INSERT INTO Commands

- According to normal SQL data definition syntax, each CREATE TABLE or INSERT INTO statement must terminate with a semicolon.
- The CREATE TABLE command supports the INTEGER, SMALLINT, FLOAT, CHARACTER, DATE, TIME, TIMESTAMP, DECIMAL, DOUBLE PRECISION and REAL data types. Decimals are rounded in the DOUBLE PRECISION and REAL data types.
- When using the CREATE TABLE and INSERT INTO commands, the data type FLOAT should be declared with a precision and used in an INSERT INTO command without the 'E' designation. This requires the entire value to be specified without an exponent.
- The CHECK and DEFAULT options are not supported with the CREATE TABLE command.

Creating a Table With Single-Record Insert

The following shows a single-record insert, creating the table U with one record:

```
-* Single-record insert example.  
-*  
SQL  
CREATE TABLE U (A INT, B CHAR(6), C CHAR(6), X INT, Y INT);  
END  
SQL  
INSERT INTO U (A,B,C,X,Y) VALUES (10, '123456','654321', 10, 15);  
END
```

Inserting Values Expressed With an Exponent

To insert the values 100.00E01 and 200.00E01, specify:

```
SQL  
CREATE TABLE T (A FLOAT(6), B CHAR(4))
```

```
END
SQL
INSERT INTO T (A,B) VALUES (1000.00, '1234');
END
SQL
INSERT INTO T (A,B) VALUES (2000.00, '4321');
END
```

SQL CREATE VIEW and DROP VIEW Commands

A view is a transient object that inherits most of the characteristics of a table. Like a table, it is composed of rows and columns:

- `CREATE VIEW` creates views. Note that it does not put the view in the system catalog.
- `DROP VIEW` explicitly removes transient tables and views from the environment.

✔ **Tip:** To use a view, issue a `SELECT` from it. You cannot issue a `TABLE` request against the view because the view is not extracted as a physical FOCUS data source. To create a HOLD file for extracted data, specify `ON TABLE HOLD` after the SQL statements. For details on creating HOLD files, see [Saving and Reusing Your Report Output](#).

Create a View

The SQL Translator supports the following SQL statement:

```
CREATE VIEW viewname AS subquery ;
```

where:

viewname

Is the name of the view.

subquery

Is a `SELECT` statement that nests inside:

- A WHERE, HAVING, or SELECT clause of another SELECT.
- An UPDATE, DELETE, or INSERT statement.
- Another subquery.

Creating and Reporting From an SQL View

The following example creates a view named XYZ:

```
SQL
CREATE VIEW XYZ
  AS SELECT CAR, MODEL
  FROM CAR;
END
```

To report from the view, issue:

```
SQL
SELECT CAR, MODEL
FROM XYZ;
END
```

According to normal SQL data definition syntax, each CREATE VIEW statement must terminate with a semicolon.

Dropping an SQL View

The following request removes the XYZ view:

```
SQL
DROP VIEW XYZ;
END
```

SQL PREPARE, EXECUTE, and COMMIT Commands

The SQL PREPARE statement creates a machine language form of an SQL statement and associates it with an identifier; you can then execute the SQL statement by referring to this identifier.

The COMMIT statement makes updates or inserts permanent, and clears all PREPARE statements.

Executing an SQL SELECT Statement Using an Identifier

The following example executes an SQL SELECT statement by referencing the identifier PREP_QUERY:

```
SQL
  PREPARE PREP_QUERY FROM
  SELECT COUNTRY
  FROM CAR
  WHERE LENGTH > ? AND COUNTRY = ?;
END
SQL
  EXECUTE PREP_QUERY USING 165, 'ITALY';
END
SQL
  EXECUTE PREP_QUERY USING 190, 'ENGLAND';
END
SQL
  EXECUTE PREP_QUERY USING 182, 'FRANCE';
END
SQL
  COMMIT;
END
```

In the statement, each question mark (?) indicates where to substitute a value. Provide the necessary values in the USING clause of the EXECUTE statement in the order of the question marks in the original statement.

Cartesian Product Style Answer Sets

The SQL Translator automatically generates Cartesian product style answer sets unless you explicitly turn this feature off. However, it is advisable to leave the `CARTESIAN` setting on, since turning it off does not comply with ANSI standards. For details on the `SET CARTESIAN` command, see [Merging Data Sources](#).

Continental Decimal Notation (CDN)

Continental Decimal Notation displays numbers using a comma to mark the decimal position and periods for separating significant digits into groups of three. This notation is available for SQL Translator requests.

Using CDN to Separate Digits

The following example creates a column defined as `1.2 + SEATS`:

```
SET CDN=ON
SQL
  SELECT SEATS + 1,2
  FROM CAR;
END
```

Specifying Field Names in SQL Requests

Specify fields in an SQL request using:

- **Delimited identifiers.** A field name may contain (but not begin with) the symbols `.`, `#`, `@`, `_`, and `$`. You must enclose such field names in double quotation marks when referring to them.
- **Qualified field names.** Qualify a field name with file and file alias names. File alias names are described in the discussion of joins in [Using SQL Translator Commands](#). See the *ibi™ FOCUS® Describing Data* manual for more information.
- **Field names with embedded blanks and special characters.** A SELECT list can

specify field names with embedded blanks or other special characters. You must enclose such field names in double quotation marks. Special characters are any characters not listed as delimited identifiers, and not contained in the national character set of the installed FOCUS environment.

Specifying a Field Name With a Delimited Identifier

The following field identifier can be included in a request:

```
"COUNTRY.NAME"
```

Qualifying a Delimited Field Name

To qualify the delimited field name COUNTRY.NAME with its file name, use:

```
CAR."COUNTRY.NAME"
```

SQL UNION, INTERSECT, and EXCEPT Operators

The SQL UNION, INTERSECT, and EXCEPT operators generate MATCH logic. The number of files that can participate is determined by the MATCH limit. UNION with parentheses is supported.

- SELECT A UNION SELECT B retrieves rows in A or B or both. (This is equivalent to the MATCH phrase OLD-OR-NEW.)
- INTERSECT retrieves rows in both A and B. (This is equivalent to the MATCH phrase OLD-AND-NEW.)
- EXCEPT retrieves rows in A, but not B. (This is equivalent to the MATCH phrase OLD-NOT-NEW.)

Match logic merges the contents of your data sources. See [Merging Data Sources](#).

Numeric Constants, Literals, Expressions, and Functions

The SQL SELECT list, WHERE predicate, and HAVING clause can include numeric constants, literals enclosed in single quotation marks, expressions, and any scalar functions. Internally, a virtual field is created for each of these in the SELECT list. The value of the virtual field is provided in the answer set.

SQL Translator Support for Date, Time, and Timestamp Fields

Several new data types have been defined for the SQL Translator to support date-time fields in the WHERE predicate or field list of a SELECT statement.

In addition, time or timestamp columns can be defined in relational or FOCUS data sources, and are accessible to the translator. Values can be entered using INSERT and UPDATE statements, and displayed in SELECT statements.

Time or timestamp data items (columns or literals) can be compared in these conditions. Time values or timestamp values can be added to or subtracted from each other, with the result being the difference in the number of seconds. Expressions of the form T + 2 HOURS or TS + 5 YEARS are allowed. These expressions are translated to calls to the date-time functions described in the *ibi™ WebFOCUS® Using Functions* manual.

All date formats for actual and virtual fields in the Master File are converted to the form YYYYMMDD. If you specify a format that lacks any component, the SQL Translator supplies a default value for the missing component. To specify a portion of a date, such as the month, use a virtual field with an alphanumeric format.

SQL Translator Support for Date, Time, and Timestamp Fields

In the following chart, fff represents the second to three decimal places (milliseconds) and ffffff represents the second to six decimal places (microseconds).

The following formats are allowed as input to the Translator:

Format	USAGE Attribute in Master File	Date Components
Date	YYMD	YYYY-MM-DD
Hour	HH	HH
Hour through minute	HHI	HH.MM
Hour through second	HHIS	HH.MM.SS
Hour through millisecond	HHISs	HH.MM.SS.fff
Hour through microsecond	HHISsm	HH.MM.SS.ffffff
Year through hour	HYYMDH	YYYY-MM-DD HH
Year through minute	HYYMDI	YYYY-MM-DD HH.MM
Year through second	HYYMDS	YYYY-MM-DD HH.MM.SS
Year through millisecond	HYYMDs	YYYY-MM-DD HH.MM.SS.fff

Format	USAGE Attribute in Master File	Date Components
Year through microsecond	HYYMDm	YYYY-MM-DD HH.MM.SS.ffffff

**Note:**

- Time information may be given to the hour, minute, second, or fraction of a second.
- The separator within date information may be either a hyphen or a slash.
- The separator within time information must be a colon.
- The separator between date and time information must be a space.

Extracting Date-Time Components Using the SQL Translator

The SQL Translator supports several functions that return components from date-time values. Use the EXTRACT statement to extract components.

Use the TRIM function to remove leading and/or trailing patterns from date, time, and timestamp values. See the *ibi™ WebFOCUS® Using Functions* manual.

Use Date, Time, and Timestamp Functions Accepted by the SQL Translator

The following functions return date-time components as integer values. Assume *x* is a date-time value:

Function	Return Value
YEAR(x)	year
MONTH(x)	month number
DAY(x)	day number
HOUR(x)	hour
MINUTE(x)	minute
SECOND(x)	second
MILLISECOND(x)	millisecond
MICROSECOND(x)	microsecond

Using SQL Translator Date, Time, and Timestamp Functions

Using the timestamp column TS whose value is '1999-11-23 07:32:16.123456':

```
YEAR(TS) = 1999  
MONTH(TS) = 11  
DAY(TS) = 23  
HOUR(TS) = 7
```

```

MINUTE(TS) = 32
SECOND(TS) = 16
MILLISECOND(TS) = 123
MICROSECOND(TS) = 123456

```

Using SQL Translator Date, Time, and Timestamp Functions in a SELECT Statement

Assume that a FOCUS data source called VIDEOTR2 includes a date-time field named TRANSDATE.

```

SQL
SELECT TRANSDATE,
YEAR(TRANSDATE), MONTH(TRANSDATE),
MINUTE(TRANSDATE)
FROM VIDEOTR2;
FILE VIDSQL
END

```

The SQL Translator produces the following virtual fields for functions, followed by a TABLE request to display the output:

```

SET COUNTWIDTH=ON
-SET SQLERRNUM = 0;
DEFINE FILE
VIDEOTR2 TEMP
SQLDEF01/I4 MISSING ON NEEDS ALL = HPART(TRANSDATE,'YEAR','I4');
SQLDEF02/I2 MISSING ON NEEDS ALL = HPART(TRANSDATE,'MONTH','I2');
SQLDEF03/I2 MISSING ON NEEDS ALL = HPART(TRANSDATE,'MINUTE','I2');
END
TABLEF FILE VIDEOTR2
PRINT TRANSDATE SQLDEF01 AS 'SQLDEF01' SQLDEF02 AS 'SQLDEF02' SQLDEF03
AS
  'SQLDEF03'
ON TABLE SET CARTESIAN ON
ON TABLE SET ASNAMES ON
ON TABLE SET HOLDLIST PRINTONLY
END

```

The output is:

TRANSDATE	SQLDEF02	SQLDEF04	SQLDEF05
1999/06/20 04:14	1999	6	14
1991/06/27 02:45	1991	6	45
1996/06/21 01:16	1996	6	16
1991/06/21 07:11	1991	6	11
1991/06/20 05:15	1991	6	15
1999/06/26 12:34	1999	6	34
1919/06/26 05:45	1919	6	45
1991/06/21 01:10	1991	6	10
1991/06/19 07:18	1991	6	18
1991/06/19 04:11	1991	6	11
1998/10/03 02:41	1998	10	41
1991/06/25 01:19	1991	6	19
1986/02/05 03:30	1986	2	30
1991/06/24 04:43	1991	6	43
1991/06/24 02:08	1991	6	8
1999/10/06 02:51	1999	10	51
1991/06/25 01:17	1991	6	17

Use the SQL Translator EXTRACT Function to Extract Date-Time Components

Use the following ANSI standard function to extract date-time components as integer values:

```
EXTRACT(component FROM value)
```

where:

component

Is one of the following: YEAR, MONTH, QUARTER, DAY, WEEKDAY, HOUR, MINUTE, SECOND, MILLISECOND, or MICROSECOND.

value

Is a date-time, DATE, TIME, or TIMESTAMP field, constant or expression.

For example, the following are equivalent:

```
EXTRACT(YEAR FROM TS)
YEAR(TS)
```

Using the EXTRACT Function

```
SELECT D. EXTRACT(YEAR FROM D), EXTRACT(MONTH FROM D),
EXTRACT(DAY FROM D) FROM T
```

This request produces rows similar to the following:

1999-01-01	1999	1	1
2000-03-03	2000	3	3

Index Optimized Retrieval

The SQL Translator improves query performance by generating optimized code that enables the underlying retrieval engine to access the selected records directly, without scanning all segment instances.

Optimized Joins

The SQL Translator accepts joins in SQL syntax. SQL language joins have no implied direction. The concepts of host and cross-referenced files do not exist in SQL.

The SQL Translator analyzes each join to identify efficient implementation. First, it assigns costs to the candidate joins in the query:

- Cost = 1 for an equijoin to a field that can participate as a cross-referenced field according to FOCUS join rules. This is common in queries against relational tables with equijoin predicates in the WHERE clause.
- Cost = 16 for an equijoin to a field that cannot participate as a cross-referenced field according to FOCUS join rules.
- Cost = 256 for a non-equijoin or an unrestricted Cartesian product.

The Translator then uses these costs to build a join structure for the query. The order of the tables in the FROM clause of the query influences the first two phases of the join analysis:

1. If there are cost=1 joins from the first table referenced in the FROM clause to the second, from the second table to the third, and so on, the Translator joins the tables in the order specified in the query. If not, it goes on to Phase 2.
2. If Phase 1 fails to generate an acceptable join structure, the Translator attempts to generate a join structure without joining any table to a table that precedes it in the FROM clause. Therefore, this phase always makes the first table referenced in the query the host table. If there is no cost=1 join between two tables, or if using one requires changing the table order, the Translator abandons Phase 2 and implements Phase 3.
3. The Translator generates the join structure from the lowest-cost joins first, and then from the more expensive joins as necessary. This sorting process may change the order in which tables are joined. The efficiency of the join that this procedure generates depends on the relative sizes of the tables being joined.

If the analysis results in joining to a table that cannot participate as a cross-referenced file according to FOCUS rules (because it lacks an index, for example), the Translator generates code to build an indexed HOLD file, and implements the join with this file. However, the HOLD file does not participate in the analysis of join order.

TABLEF Optimization

To improve performance, the SQL Translator can be set to generate FOCUS TABLEF commands instead of TABLE commands. Take advantage of this optimization using the SET SQLTOPTTF command (SQL Translator OpTimization TableF). See [Improving Report Processing](#).

Improve Performance Using SQLTOPTTF

```
SET SQLTOPTTF = {ON|OFF}
```

where:

ON

Causes TABLEF commands to be generated when possible (for example, if there is no join or GROUP BY phrase). ON is the default value.

OFF

Causes TABLE commands to be generated.

SQL INSERT, UPDATE, and DELETE Commands

The SQL INSERT, UPDATE, and DELETE commands enable SQL users to manipulate and modify data:

- The INSERT statement introduces new rows into an existing table.
- The DELETE statement removes a row or combination of rows from a table.
- The UPDATE statement enables users to update a row or group of rows in a table.

You can issue an SQL INSERT, UPDATE, or DELETE command against one segment instance (row) at a time. When you issue one of these commands against a multi-segment Master File:

- All fields referenced in the command must be on a single path through the file structure.
- The command must explicitly specify (in the WHERE predicate) every key value from the root to the target segment instance, and this combination of key values must uniquely identify one segment instance (row) to be affected by the command.

If you are modifying every field in the row, you can omit the list of field names from the command.

- The SQL Translator supports subqueries, such as:

```
INSERT...INTO...SELECT...FROM...
```

Although each INSERT, UPDATE, or DELETE command can specify only one row, referential integrity constraints may produce the following modifications to the data source:

- If you delete a segment instance that has descendant segment instances (children), the children are automatically deleted.

- If you insert a segment for which parent segments are missing, the parent segments are automatically created.

Master Files and Diagrams

This appendix contains descriptions and structure diagrams for the sample data sources used throughout the documentation.

EMPLOYEE Data Source

EMPLOYEE contains sample data about company employees. Its segments are:

EMPINFO

Contains employee IDs, names, and positions.

FUNDTRAN

Specifies employee direct deposit accounts. This segment is unique.

PAYINFO

Contains the employee salary history.

ADDRESS

Contains employee home and bank addresses.

SALINFO

Contains data on employee monthly pay.

DEDUCT

Contains data on monthly pay deductions.

EMPLOYEE also contains cross-referenced segments belonging to the JOBFILE and EDUCFILE files, also described in this appendix. The segments are:

JOBSEG (from JOBFILE)

Describes the job positions held by each employee.

SKILLSEG (from JOBFILE)

Lists the skills required by each position.

SECSEG (from JOBFILE)

Specifies the security clearance needed for each job position.

ATTNDSEG (from EDUCFILE)

Lists the dates that employees attended in-house courses.

COURSESEG (from EDUCFILE)

Lists the courses that the employees attended.

EMPLOYEE Master File

```

FILENAME=EMPLOYEE, SUFFIX=FOC
SEGNAME=EMPINFO, SEGTYPE=S1
  FIELDNAME=EMP_ID, ALIAS=EID, FORMAT=A9, $
  FIELDNAME=LAST_NAME, ALIAS=LN, FORMAT=A15, $
  FIELDNAME=FIRST_NAME, ALIAS=FN, FORMAT=A10, $
  FIELDNAME=HIRE_DATE, ALIAS=HDT, FORMAT=I6YMD, $
  FIELDNAME=DEPARTMENT, ALIAS=DPT, FORMAT=A10, $
  FIELDNAME=CURR_SAL, ALIAS=CSAL, FORMAT=D12.2M, $
  FIELDNAME=CURR_JOBCODE, ALIAS=CJC, FORMAT=A3, $
  FIELDNAME=ED_HRS, ALIAS=OJT, FORMAT=F6.2, $
SEGNAME=FUNDTRAN, SEGTYPE=U, PARENT=EMPINFO
  FIELDNAME=BANK_NAME, ALIAS=BN, FORMAT=A20, $
  FIELDNAME=BANK_CODE, ALIAS=BC, FORMAT=I6S, $
  FIELDNAME=BANK_ACCT, ALIAS=BA, FORMAT=I9S, $
  FIELDNAME=EFFECT_DATE, ALIAS=EDATE, FORMAT=I6YMD, $
SEGNAME=PAYINFO, SEGTYPE=SH1, PARENT=EMPINFO
  FIELDNAME=DAT_INC, ALIAS=DI, FORMAT=I6YMD, $
  FIELDNAME=PCT_INC, ALIAS=PI, FORMAT=F6.2, $
  FIELDNAME=SALARY, ALIAS=SAL, FORMAT=D12.2M, $
  FIELDNAME=JOBCODE, ALIAS=JBC, FORMAT=A3, $
SEGNAME=ADDRESS, SEGTYPE=S1, PARENT=EMPINFO
  FIELDNAME=TYPE, ALIAS=AT, FORMAT=A4, $
  FIELDNAME=ADDRESS_LN1, ALIAS=LN1, FORMAT=A20, $
  FIELDNAME=ADDRESS_LN2, ALIAS=LN2, FORMAT=A20, $
  FIELDNAME=ADDRESS_LN3, ALIAS=LN3, FORMAT=A20, $
  FIELDNAME=ACCTNUMBER, ALIAS=ANO, FORMAT=I9L, $
SEGNAME=SALINFO, SEGTYPE=SH1, PARENT=EMPINFO

```

```

FIELDNAME=PAY_DATE,      ALIAS=PD,      FORMAT=I6YMD,      $
FIELDNAME=GROSS,        ALIAS=MO_PAY,  FORMAT=D12.2M,     $
SEGNAME=DEDUCT,         SEGTYPE=S1,    PARENT=SALINFO
FIELDNAME=DED_CODE,     ALIAS=DC,      FORMAT=A4,          $
FIELDNAME=DED_AMT,      ALIAS=DA,      FORMAT=D12.2M,     $
SEGNAME=JOBSEG,         SEGTYPE=KU,    PARENT=PAYINFO,    CRFILE=JOBFILE,
CRKEY=JOBCODE,$
SEGNAME=SECSEG,         SEGTYPE=KLU,   PARENT=JOBSEG,     CRFILE=JOBFILE, $
SEGNAME=SKILLSEG,      SEGTYPE=KL,    PARENT=JOBSEG,     CRFILE=JOBFILE, $
SEGNAME=ATTNDSEG,      SEGTYPE=KM,    PARENT=EMPINFO,    CRFILE=EDUCFILE,
CRKEY=EMP_ID,$
SEGNAME=COURSESEG,     SEGTYPE=KLU,   PARENT=ATTNDSEG,   CRFILE=EDUCFILE,$
    
```

EMPLOYEE Structure Diagram

The EMPLOYEE structure follows:

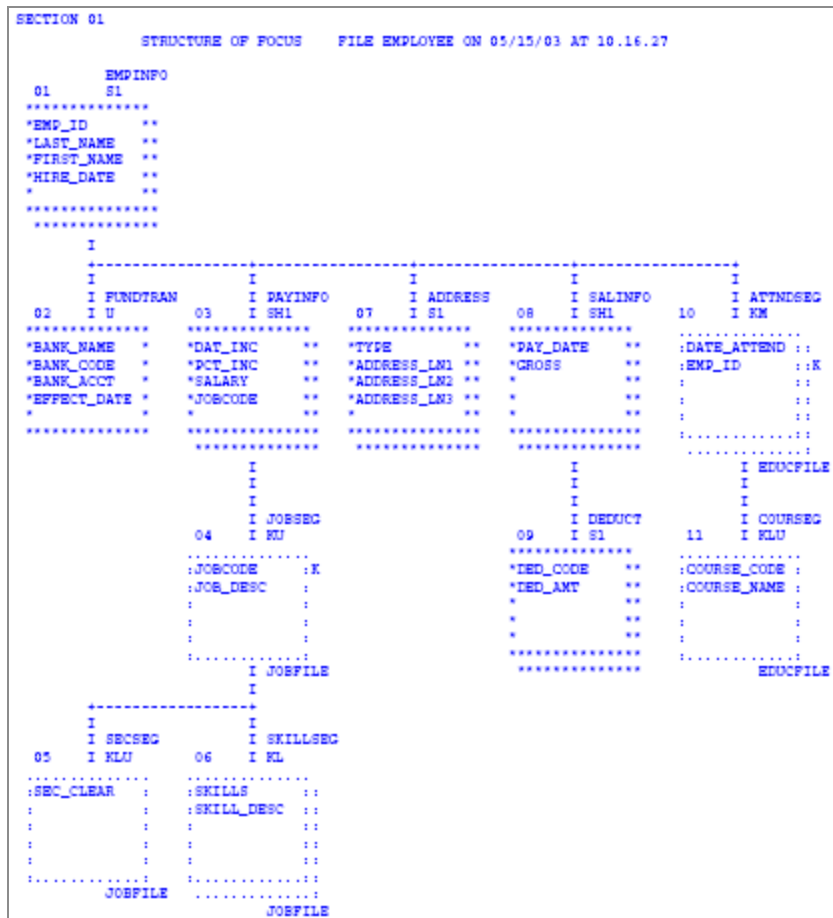

JOBFILE Data Source

JOBFILE contains sample data about company job positions. Its segments are:

JOBSEG

Describes what each position is. The field JOBCODE in this segment is indexed.

SKILLSEG

Lists the skills required by each position.

SECSEG

Specifies the security clearance needed, if any. This segment is unique.

JOBFILE Master File

```

FILENAME=JOBFILE,  SUFFIX=FOC
SEGNAME=JOBSEG,   SEGTYPE=S1
  FIELDNAME=JOBCODE,  ALIAS=JC,  FORMAT=A3,    INDEX=I,$
  FIELDNAME=JOB_DESC, ALIAS=JD,  FORMAT=A25,    , $
SEGNAME=SKILLSEG,  SEGTYPE=S1,  PARENT=JOBSEG
  FIELDNAME=SKILLS,  ALIAS=,     FORMAT=A4,    , $
  FIELDNAME=SKILL_DESC, ALIAS=SD,  FORMAT=A30,   , $
SEGNAME=SECSEG,   SEGTYPE=U,   PARENT=JOBSEG
  FIELDNAME=SEC_CLEAR, ALIAS=SC,  FORMAT=A6,    , $

```

JOBFILE Structure Diagram

```

SECTION 01
          STRUCTURE OF FOCUS      FILE JOBFILE ON 05/15/03 AT 14.40.06

          JOBSEG
01        S1
*****
*JOBCODE   **I
*JOB_DESC  **
*          **

```

```

*                **
*                **
*****
*****
      I
      +-----+
      I                I
      I SECSEG        I SKILLSEG
02   I U            03   I S1
*****
*SEC_CLEAR *      *SKILLS **
*          *      *SKILL_DESC **
*          *      *          **
*          *      *          **
*          *      *          **
*****
*****
*****

```

EDUCFILE Data Source

EDUCFILE contains sample data about company in-house courses. Its segments are:

COURSEG

Contains data on each course.

ATTNDSEG

Specifies which employees attended the courses. Both fields in the segment are key fields. The field EMP_ID in this segment is indexed.

EDUCFILE Master File

```

FILENAME=EDUCFILE, SUFFIX=FOC
SEGNAME=COURSEG, SEGTYPE=S1
  FIELDNAME=COURSE_CODE, ALIAS=CC, FORMAT=A6, $
  FIELDNAME=COURSE_NAME, ALIAS=CD, FORMAT=A30, $
SEGNAME=ATTNDSEG, SEGTYPE=SH2, PARENT=COURSEG
  FIELDNAME=DATE_ATTEND, ALIAS=DA, FORMAT=I6YMD, $
  FIELDNAME=EMP_ID, ALIAS=EID, FORMAT=A9, INDEX=I, $

```

EDUCFILE Structure Diagram

```

SECTION 01
          STRUCTURE OF FOCUS      FILE EDUCFILE ON 05/15/03 AT
14.45.44

          COURSEG
01      S1
*****
*COURSE_CODE **
*COURSE_NAME **
*           **
*           **
*           **
*****
          I
          I
          I
          I ATTNDSEG
02      I SH2
*****
*DATE_ATTEND **
*EMP_ID      **I
*           **
*           **
*           **
*****
          *****
          *****

```

SALES Data Source

SALES contains sample data about a dairy company with an affiliated store chain. Its segments are:

STOR_SEG

Lists the stores buying the products.

DAT_SEG

Contains the dates of inventory.

PRODUCT

Contains sales data for each product on each date. The PROD_CODE field is indexed. The RETURNS and DAMAGED fields have the MISSING=ON attribute.

SALES Master File

```

FILENAME=KSALES,   SUFFIX=FOC
SEGNAME=STOR_SEG, SEGTYPE=S1
  FIELDNAME=STORE_CODE, ALIAS=SNO,   FORMAT=A3,   $
  FIELDNAME=CITY,       ALIAS=CTY,   FORMAT=A15,  $
  FIELDNAME=AREA,       ALIAS=LOC,   FORMAT=A1,   $
SEGNAME=DATE_SEG, PARENT=STOR_SEG, SEGTYPE=SH1,
  FIELDNAME=DATE,       ALIAS=DTE,   FORMAT=A4MD, $
SEGNAME=PRODUCT,  PARENT=DATE_SEG, SEGTYPE=S1,
  FIELDNAME=PROD_CODE, ALIAS=PCODE,  FORMAT=A3,   FIELDTYPE=I,$
  FIELDNAME=UNIT_SOLD, ALIAS=SOLD,   FORMAT=I5,   $
  FIELDNAME=RETAIL_PRICE,ALIAS=RP,   FORMAT=D5.2M,$
  FIELDNAME=DELIVER_AMT,ALIAS=SHIP,  FORMAT=I5,   $
  FIELDNAME=OPENING_AMT,ALIAS=INV,   FORMAT=I5,   $
  FIELDNAME=RETURNS,   ALIAS=RTN,   FORMAT=I3,   MISSING=ON,$
  FIELDNAME=DAMAGED,   ALIAS=BAD,   FORMAT=I3,   MISSING=ON,$

```

SALES Structure Diagram

SECTION 01

STRUCTURE OF FOCUS

FILE SALES ON 05/15/03 AT 14.50.28

```

          STOR_SEG
01      S1
*****
*STORE_CODE **
*CITY      **
*AREA      **
*          **
*          **
*****
*****
          I
          I

```



```

      I
      I DATE_SEG
02    I SH1
*****
*DATE          **
*              **
*              **
*              **
*              **
*****
*****
      I
      I
      I
      I PRODUCT
03    I S1
*****
*PROD_CODE    **I
*UNIT_SOLD    **
*RETAIL_PRICE**
*DELIVER_AMT **
*              **
*****
*****

```

CAR Data Source

CAR contains sample data about specifications and sales information for rare cars. Its segments are:

ORIGIN

Lists the country that manufactures the car. The field COUNTRY is indexed.

COMP

Contains the car name.

CARREC

Contains the car model.

BODY

Lists the body type, seats, dealer and retail costs, and units sold.

SPECS

Lists car specifications. This segment is unique.

WARANT

Lists the type of warranty.

EQUIP

Lists standard equipment.

The aliases in the CAR Master File are specified without the ALIAS keyword.

CAR Master File

```
FILENAME=CAR,SUFFIX=FOC
SEGNAME=ORIGIN,SEGTYPE=S1
  FIELDNAME=COUNTRY,COUNTRY,A10,FIELDTYPE=I,$
SEGNAME=COMP,SEGTYPE=S1,PARENT=ORIGIN
  FIELDNAME=CAR,CARS,A16,$
SEGNAME=CARREC,SEGTYPE=S1,PARENT=COMP
  FIELDNAME=MODEL,MODEL,A24,$
SEGNAME=BODY,SEGTYPE=S1,PARENT=CARREC
  FIELDNAME=BODYTYPE,TYPE,A12,$
  FIELDNAME=SEATS,SEAT,I3,$
  FIELDNAME=DEALER_COST,DCOST,D7,$
  FIELDNAME=RETAIL_COST,RCOST,D7,$
  FIELDNAME=SALES,UNITS,I6,$
SEGNAME=SPECS,SEGTYPE=U,PARENT=BODY
  FIELDNAME=LENGTH,LEN,D5,$
  FIELDNAME=WIDTH,WIDTH,D5,$
  FIELDNAME=HEIGHT,HEIGHT,D5,$
  FIELDNAME=WEIGHT,WEIGHT,D6,$
  FIELDNAME=WHEELBASE,BASE,D6.1,$
  FIELDNAME=FUEL_CAP,FUEL,D6.1,$
  FIELDNAME=BHP,POWER,D6,$
  FIELDNAME=RPM,RPM,I5,$
  FIELDNAME=MPG,MILES,D6,$
  FIELDNAME=ACCEL,SECONDS,D6,$
SEGNAME=WARANT,SEGTYPE=S1,PARENT=COMP
  FIELDNAME=WARRANTY,WARR,A40,$
SEGNAME=EQUIP,SEGTYPE=S1,PARENT=COMP
  FIELDNAME=STANDARD,EQUIP,A40,$
```

CAR Structure Diagram

```

SECTION 01          STRUCTURE OF FOCUS   FILE CAR      ON 04/06/07 AT 11.13.56

      ORIGIN
01     S1
*****
* COUNTRY      **I
*
*
*
*****
      I
      I
      I
      I COMP
02     I S1
*****
* CAR
*
*
*
*****
      I
      I-----+-----+
      I CARREC      I WARRANT      I EQUIP
03     I S1          06     I S1      07     I S1
*****          *****          *****
* MODEL         ** WARRANTY ** * STANDARD **
*
*
*
*****          *****          *****
      I
      I
      I
      I BODY
04     I S1
*****
* BODYTYPE     **
* SEATS        **
* DEALER_COST **
* RETAIL_COST **
*
*
*****
      I
      I
      I
      I SPECS
05     I U
*****
* LENGTH      *
* WIDTH       *
* HEIGHT      *
* WEIGHT       *
*
*****
    
```

LEDGER Data Source

LEDGER contains sample accounting data. It consists of one segment, TOP. This data source is specified primarily for FML examples. Aliases do not exist for the fields in this Master File, and the commas act as placeholders.

LEDGER Master File

```
FILENAME=LEDGER, SUFFIX=FOC,$
SEGNAME=TOP, SEGTYPE=S2,$
FIELDNAME=YEAR , , FORMAT=A4, $
FIELDNAME=ACCOUNT, , FORMAT=A4, $
FIELDNAME=AMOUNT , , FORMAT=I5C,$
```

LEDGER Structure Diagram

```
SECTION 01
          STRUCTURE OF FOCUS      FILE LEDGER      ON 05/15/03 AT 15.17.08

          TOP
01       S2
*****
*YEAR          **
*ACCOUNT       **
*AMOUNT        **
*              **
*              **
*****
*****
```

FINANCE Data Source

FINANCE contains sample financial data for balance sheets. It consists of one segment, TOP. This data source is specified primarily for FML examples. Aliases do not exist for the fields in this Master File, and the commas act as placeholders.

FINANCE Master File

```
FILENAME=FINANCE, SUFFIX=FOC,$
SEGNAME=TOP, SEGTYPE=S2,$
```

```

FIELDNAME=YEAR      , , FORMAT=A4, $
FIELDNAME=ACCOUNT, , FORMAT=A4, $
FIELDNAME=AMOUNT   , , FORMAT=D12C,$

```

FINANCE Structure Diagram

```

SECTION 01
          STRUCTURE OF FOCUS      FILE FINANCE  ON 05/15/03 AT 15.17.08

          TOP
01        S2
*****
*YEAR          **
*ACCOUNT       **
*AMOUNT        **
*              **
*              **
*****
*****

```

REGION Data Source

REGION contains sample account data for the eastern and western regions of the country. It consists of one segment, TOP. This data source is specified primarily for FML examples. Aliases do not exist for the fields in this Master File, and the commas act as placeholders.

REGION Master File

```

FILENAME=REGION, SUFFIX=FOC,$
SEGNAME=TOP,     SEGTYPE=S1,$
  FIELDNAME=ACCOUNT, , FORMAT=A4, $
  FIELDNAME=E_ACTUAL, , FORMAT=I5C,$
  FIELDNAME=E_BUDGET, , FORMAT=I5C,$
  FIELDNAME=W_ACTUAL, , FORMAT=I5C,$
  FIELDNAME=W_BUDGET, , FORMAT=I5C,$

```

REGION Structure Diagram

```
SECTION 01
          STRUCTURE OF FOCUS      FILE REGION      ON 05/15/03 AT 15.18.48

          TOP
01        S1
*****
*ACCOUNT      **
*E_ACTUAL     **
*E_BUDGET     **
*W_ACTUAL     **
*              **
*****
*****
```

EMPDATA Data Source

EMPDATA contains sample data about company employees. It consists of one segment, EMPDATA. The PIN field is indexed. The AREA field is a temporary field.

EMPDATA Master File

```
FILENAME=EMPDATA, SUFFIX=FOC
SEGNAME=EMPDATA, SEGTYPE=S1
  FIELDNAME=PIN,          ALIAS=ID,          FORMAT=A9,  INDEX=I,    $
  FIELDNAME=LASTNAME,    ALIAS=LN,          FORMAT=A15,          $
  FIELDNAME=FIRSTNAME,  ALIAS=FN,          FORMAT=A10,          $
  FIELDNAME=MIDINITIAL, ALIAS=MI,          FORMAT=A1,           $
  FIELDNAME=DIV,         ALIAS=CDIV,        FORMAT=A4,           $
  FIELDNAME=DEPT,       ALIAS=CDEPT,       FORMAT=A20,          $
  FIELDNAME=JOBCLASS,   ALIAS=CJCLAS,      FORMAT=A8,           $
  FIELDNAME=TITLE,     ALIAS=CFUNC,       FORMAT=A20,          $
  FIELDNAME=SALARY,    ALIAS=CSAL,        FORMAT=D12.2M,       $
  FIELDNAME=HIREDATE,  ALIAS=HDAT,        FORMAT=YMD,          $
$
DEFINE AREA/A13=DECODE DIV (NE 'NORTH EASTERN' SE 'SOUTH EASTERN'
CE 'CENTRAL' WE 'WESTERN' CORP 'CORPORATE' ELSE 'INVALID AREA');$
```

EMPDATA Structure Diagram

```
SECTION 01
          STRUCTURE OF FOCUS      FILE EMPDATA  ON 05/15/03 AT 14.49.09

          EMPDATA
01      S1
*****
*PIN          **I
*LASTNAME     **
*FIRSTNAME    **
*MIDINITIAL   **
*             **
*****
*****
```

TRAINING Data Source

TRAINING contains sample data about training courses for employees. It consists of one segment, TRAINING. The PIN field is indexed. The EXPENSES, GRADE, and LOCATION fields have the MISSING=ON attribute.

TRAINING Master File

```
FILENAME=TRAINING, SUFFIX=FOC
SEGNAME=TRAINING, SEGTYPE=SH3
FIELDNAME=PIN,      ALIAS=ID,      FORMAT=A9,      INDEX=I,      $
FIELDNAME=COURSESTART, ALIAS=CSTART,  FORMAT=YMD,      $
FIELDNAME=COURSECODE, ALIAS=CCOD,    FORMAT=A7,      $
FIELDNAME=EXPENSES,  ALIAS=COST,    FORMAT=D8.2,    MISSING=ON    $
FIELDNAME=GRADE,     ALIAS=GRA,     FORMAT=A2,      MISSING=ON,   $
FIELDNAME=LOCATION,    ALIAS=LOC,     FORMAT=A6,      MISSING=ON,   $
```

TRAINING Structure Diagram

SECTION 01

STRUCTURE OF FOCUS

FILE TRAINING ON 05/15/03 AT 14.51.28

```

      TRAINING
01      SH3
*****
*PIN          **I
*COURSESTART **
*COURSECODE   **
*EXPENSES     **
*             **
*****
*****

```

COURSE Data Source

COURSE contains sample data about education courses. It consists of one segment, CRSELIST.

COURSE Master File

```

FILENAME=COURSE,   SUFFIX=FOC
SEGNAME=CRSELIST, SEGTYPE=S1
  FIELDNAME=COURSECODE, ALIAS=CCOD,   FORMAT=A7,   INDEX=I,   $
  FIELDNAME=CTITLE,     ALIAS=COURSE, FORMAT=A35,   $
  FIELDNAME=SOURCE,     ALIAS=ORG,   FORMAT=A35,   $
  FIELDNAME=CLASSIF,    ALIAS=CLASS, FORMAT=A10,   $
  FIELDNAME=TUITION,    ALIAS=FEE,   FORMAT=D8.2,  MISSING=ON, $
  FIELDNAME=DURATION,   ALIAS=DAYS,  FORMAT=A3,    MISSING=ON, $
  FIELDNAME=DESCRIPTN1, ALIAS=DESC1, FORMAT=A40,   $
  FIELDNAME=DESCRIPTN2, ALIAS=DESC2, FORMAT=A40,   $
  FIELDNAME=DESCRIPTN2, ALIAS=DESC3, FORMAT=A40,   $

```

COURSE Structure Diagram

```
SECTION 01
          STRUCTURE OF FOCUS      FILE COURSE      ON 05/15/03 AT 12.26.05
```

```
          CRSELIST
01          S1
*****
*COURSECODE  **I
*CTITLE      **
*SOURCE      **
*CLASSIF     **
*            **
*****
*****
```

JOBHIST Data Source

JOBHIST contains information about employee jobs. Both the PIN and JOBSTART fields are keys. The PIN field is indexed.

JOBHIST Master File

```
FILENAME=JOBHIST, SUFFIX=FOC
SEGNAME=JOBHIST, SEGTYPE=SH2
FIELDNAME=PIN,           ALIAS=ID,           FORMAT=A9,           INDEX=I , $
FIELDNAME=JOBSTART,     ALIAS=SDAT,        FORMAT=YMD,           $
FIELDNAME=JOBCLASS,     ALIAS=JCLASS,     FORMAT=A8,           $
FIELDNAME=FUNCTITLE,    ALIAS=FUNC,        FORMAT=A20,          $
```

JOBHIST Structure Diagram

```
SECTION 01
          STRUCTURE OF FOCUS      FILE JOBHIST      ON 01/22/08 AT 16.23.46
```

```

JOBHIST
01      SH2
*****
*PIN          **I
*JOBSTART     **
*JOBCLASS     **
*FUNCTITLE    **
*             **
*****
*****

```

JOBLIST Data Source

JOBLIST contains information about jobs. The JOBCLASS field is indexed.

JOBLIST Master File

```

FILENAME=JOBLIST, SUFFIX=FOC
SEGNAME=JOBSEG,  SEGTYPE=S1
FIELDNAME=JOBCLASS, ALIAS=JCLASS,  FORMAT=A8, INDEX=I , $
FIELDNAME=CATEGORY, ALIAS=JGROUP,  FORMAT=A25, $
FIELDNAME=JOBDESC,  ALIAS=JDESC,   FORMAT=A40, $
FIELDNAME=LOWSAL,   ALIAS=LSAL,    FORMAT=D12.2M, $
FIELDNAME=HIGHSAL,  ALIAS=HSAL,    FORMAT=D12.2M, $
DEFINE GRADE/A2=EDIT (JCLASS,'$$$99');$
DEFINE LEVEL/A25=DECODE GRADE (08 'GRADE 8' 09 'GRADE 9' 10
'GRADE 10' 11 'GRADE 11' 12 'GRADE 12' 13 'GRADE 13' 14 'GRADE 14');$

```

JOBLIST Structure Diagram

```

SECTION 01
          STRUCTURE OF FOCUS   FILE JOBLIST  ON 01/22/08 AT
16.24.52
          JOBSEG
01      S1
*****

```

```

*JOBCLASS      **I
*CATEGORY      **
*JOBDESC       **
*LOWSAL        **
*              **
*****
*****

```

LOCATOR Data Source

JOBHIST contains information about employee location and phone number. The PIN field is indexed.

LOCATOR Master File

```

FILENAME=LOCATOR, SUFFIX=FOC
SEGNAME=LOCATOR,  SEGTYPE=S1,
FIELDNAME=PIN,    ALIAS=ID_NO,   FORMAT=A9,   INDEX=I,   $
FIELDNAME=SITE,   ALIAS=SITE,   FORMAT=A25,  $
FIELDNAME=FLOOR,  ALIAS=FL,    FORMAT=A3,   $
FIELDNAME=ZONE,   ALIAS=ZONE,  FORMAT=A2,   $
FIELDNAME=BUS_PHONE, ALIAS=BTEL,  FORMAT=A5,   $

```

LOCATOR Structure Diagram

```

SECTION 01
                STRUCTURE OF FOCUS   FILE LOCATOR   ON 01/22/08 AT
16.26.55
                LOCATOR
  01           S1
*****
*PIN          **I
*SITE         **
*FLOOR        **
*ZONE         **

```

```

*                **
*****
*****

```

PERSINFO Data Source

PERSINFO contains employee personal information. The PIN field is indexed.

PERSINFO Master File

```

FILENAME=PERSINFO, SUFFIX=FOC
SEGNAME=PERSONAL, SEGTYPE=S1
FIELDNAME=PIN,          ALIAS=ID,          FORMAT=A9,    INDEX=I,    $
FIELDNAME=INCAREOF,    ALIAS=ICO,          FORMAT=A35,    $
FIELDNAME=STREETNO,    ALIAS=STR,          FORMAT=A20,    $
FIELDNAME=APT,         ALIAS=APT,          FORMAT=A4,     $
FIELDNAME=CITY,        ALIAS=CITY,         FORMAT=A20,    $
FIELDNAME=STATE,       ALIAS=PROV,         FORMAT=A4,     $
FIELDNAME=POSTALCODE,  ALIAS=ZIP,          FORMAT=A10,    $
FIELDNAME=COUNTRY,     ALIAS=CTRY,         FORMAT=A15,    $
FIELDNAME=HOMEPHONE,   ALIAS=TEL,          FORMAT=A10,    $
FIELDNAME=EMERGENCYNO, ALIAS=ENO,          FORMAT=A10,    $
FIELDNAME=EMERGCONTACT, ALIAS=ENAME,        FORMAT=A35,    $
FIELDNAME=RELATIONSHIP, ALIAS=REL,          FORMAT=A8,     $
FIELDNAME=BIRTHDATE,   ALIAS=BDAT,         FORMAT=YMD,    $

```

PERSINFO Structure Diagram

```

SECTION 01
  STRUCTURE OF FOCUS   FILE PERSINFO ON 01/22/08 AT 16.27.24
  PERSONAL
  01      S1
  *****
  *PIN          **I
  *INCAREOF     **
  *STREETNO     **

```

```

*APT          **
*            **
*****
*****

```

SALHIST Data Source

SALHIST contains information about employee salary history. The PIN field is indexed. Both the PIN and EFFECTDATE fields are keys.

SALHIST Master File

```

FILENAME=SALHIST,  SUFFIX=FOC
SEGNAME=SLHISTRY,  SEGTYPE=SH2
FIELDNAME=PIN,     ALIAS=ID,     FORMAT=A9,     INDEX=I,     $
FIELDNAME=EFFECTDATE, ALIAS=EDAT,   FORMAT=YMD,     $
FIELDNAME=OLDSALARY, ALIAS=OSAL,   FORMAT=D12.2,   $

```

SALHIST Structure Diagram

```

SECTION 01
  STRUCTURE OF FOCUS   FILE SALHIST   ON 01/22/08 AT 16.28.02
  SLHISTRY
  01      SH2
  *****
  *PIN          **I
  *EFFECTDATE  **
  *OLDSALARY   **
  *            **
  *            **
  *****
  *****

```

VIDEOTRK, MOVIES, and ITEMS Data Sources

VIDEOTRK contains sample data about customer, rental, and purchase information for a video rental business. It can be joined to the MOVIES or ITEMS data source. VIDEOTRK and MOVIES are used in examples that illustrate the use of the Maintain Data facility.

VIDEOTRK Master File

```

FILENAME=VIDEOTRK, SUFFIX=FOC
SEGNAME=CUST,      SEGTYPE=S1
  FIELDNAME=CUSTID,    ALIAS=CIN,          FORMAT=A4,    $
  FIELDNAME=LASTNAME, ALIAS=LN,          FORMAT=A15,   $
  FIELDNAME=FIRSTNAME, ALIAS=FN,          FORMAT=A10,   $
  FIELDNAME=EXPDATE,   ALIAS=EXDAT,        FORMAT=YMD,   $
  FIELDNAME=PHONE,     ALIAS=TEL,          FORMAT=A10,   $
  FIELDNAME=STREET,    ALIAS=STR,          FORMAT=A20,   $
  FIELDNAME=CITY,      ALIAS=CITY,         FORMAT=A20,   $
  FIELDNAME=STATE,     ALIAS=PROV,         FORMAT=A4,    $
  FIELDNAME=ZIP,       ALIAS=POSTAL_CODE,  FORMAT=A9,    $
SEGNAME=TRANSDAT, SEGTYPE=SH1, PARENT=CUST
  FIELDNAME=TRANSDATE, ALIAS=OUTDATE,    FORMAT=YMD,   $
SEGNAME=SALES,      SEGTYPE=S2, PARENT=TRANSDAT
  FIELDNAME=PRODCODE,  ALIAS=PCOD,        FORMAT=A6,    $
  FIELDNAME=TRANSCODE, ALIAS=TCOD,        FORMAT=I3,    $
  FIELDNAME=QUANTITY,  ALIAS=NO,          FORMAT=I3S,   $
  FIELDNAME=TRANSTOT,  ALIAS=TTOT,        FORMAT=F7.2S, $
SEGNAME=RENTALS,   SEGTYPE=S2, PARENT=TRANSDAT
  FIELDNAME=MOVIECODE, ALIAS=MCOD,        FORMAT=A6, INDEX=I, $
  FIELDNAME=COPY,      ALIAS=COPY,        FORMAT=I2,    $
  FIELDNAME=RETURNDATE, ALIAS=INDATE,     FORMAT=YMD,   $
  FIELDNAME=FEE,       ALIAS=FEE,          FORMAT=F5.2S, $

```

VIDEOTRK Structure Diagram

```

SECTION 01
          STRUCTURE OF FOCUS      FILE VIDEOTRK ON 05/15/03 AT 12.25.19

01      CUST
        S1

```

```

*****
*CUSTID      **
*LASTNAME   **
*FIRSTNAME  **
*EXPDATE    **
*           **
*****
*****
      I
      I
      I
      I  TRANSDAT
02      I  SH1
*****
*TRANSDATE  **
*           **
*           **
*           **
*           **
*****
*****
      I
      +-----+
      I           I
      I  SALES     I  RENTALS
03      I  S2      04      I  S2
*****          *****
*PRODCODE    **  *MOVIECODE  **I
*TRANSCODE   **  *COPY       **
*QUANTITY    **  *RETURNDATE **
*TRANSTOT    **  *FEE        **
*           **  *           **
*****          *****
*****          *****

```

MOVIES Master File

```

FILENAME=MOVIES,      SUFFIX=FOC
SEGNAME=MOVINFO,     SEGTYPE=S1
  FIELDNAME=MOVIECODE,  ALIAS=MCOD,  FORMAT=A6, INDEX=I, $
  FIELDNAME=TITLE,     ALIAS=MTL,   FORMAT=A39, $
  FIELDNAME=CATEGORY,  ALIAS=CLASS, FORMAT=A8, $
  FIELDNAME=DIRECTOR,  ALIAS=DIR,   FORMAT=A17, $

```

```

FIELDNAME=RATING,      ALIAS=RTG,    FORMAT=A4,    $
FIELDNAME=RELDATE,    ALIAS=RDAT,  FORMAT=YMD,   $
FIELDNAME=WHOLESALEPR, ALIAS=WPRC,  FORMAT=F6.2,  $
FIELDNAME=LISTPR,     ALIAS=LPRC,  FORMAT=F6.2,  $
FIELDNAME=COPIES,     ALIAS=NOC,   FORMAT=I3,    $

```

MOVIES Structure Diagram

SECTION 01

STRUCTURE OF FOCUS FILE MOVIES ON 05/15/03 AT 12.26.05

```

          MOVINFO
01      S1
*****
*MOVIECODE **I
*TITLE     **
*CATEGORY  **
*DIRECTOR  **
*          **
*****
*****

```

ITEMS Master File

```

FILENAME=ITEMS,    SUFFIX=FOC
SEGNAME=ITMINFO,  SEGTYPE=S1
FIELDNAME=PRODCODE, ALIAS=PCOD,  FORMAT=A6,  INDEX=I,  $
FIELDNAME=PRODNAME, ALIAS=PROD,  FORMAT=A20,  $
FIELDNAME=OURCOST,  ALIAS=WCost,  FORMAT=F6.2,  $
FIELDNAME=RETAILPR, ALIAS=PRICE,  FORMAT=F6.2,  $
FIELDNAME=ON_HAND,  ALIAS=NUM,    FORMAT=I5,    $

```

ITEMS Structure Diagram

```
SECTION 01
          STRUCTURE OF FOCUS   FILE ITEMS   ON 05/15/03 AT 12.26.05
```

```
          ITMINFO
01      S1
*****
*PRODCODE   **I
*PRODNAME   **
*OURCOST    **
*RETAILPR   **
*           **
*****
*****
```

VIDEOTR2 Data Source

VIDEOTR2 contains sample data about customer, rental, and purchase information for a video rental business. It consists of four segments.

VIDEOTR2 Master File

```
FILENAME=VIDEOTR2, SUFFIX=FOC
SEGNAME=CUST,      SEGTYPE=S1
  FIELDNAME=CUSTID,    ALIAS=CIN,      FORMAT=A4,      $
  FIELDNAME=LASTNAME, ALIAS=LN,      FORMAT=A15,     $
  FIELDNAME=FIRSTNAME, ALIAS=FN,      FORMAT=A10,     $
  FIELDNAME=EXPDATE,  ALIAS=EXDAT,   FORMAT=YMD,     $
  FIELDNAME=PHONE,    ALIAS=TEL,     FORMAT=A10,     $
  FIELDNAME=STREET,   ALIAS=STR,     FORMAT=A20,     $
  FIELDNAME=CITY,     ALIAS=CITY,    FORMAT=A20,     $
  FIELDNAME=STATE,    ALIAS=PROV,    FORMAT=A4,      $
  FIELDNAME=ZIP,      ALIAS=POSTAL_CODE, FORMAT=A9,      $
  FIELDNAME=EMAIL,    ALIAS=EMAIL,   FORMAT=A18,     $
SEGNAME=TRANSDAT, SEGTYPE=SH1, PARENT=CUST
  FIELDNAME=TRANSDATE, ALIAS=OUTDATE,  FORMAT=HYYMDI,  $
SEGNAME=SALES,      SEGTYPE=S2, PARENT=TRANSDAT
  FIELDNAME=TRANSCODE, ALIAS=TCOD,     FORMAT=I3,      $
```

```

FIELDNAME=QUANTITY,      ALIAS=NO,          FORMAT=I3S,          $
FIELDNAME=TRANSTOT,     ALIAS=TTOT,       FORMAT=F7.2S,       $
SEGNAME=RENTALS,        SEGTYPE=S2,        PARENT=TRANSDAT
FIELDNAME=MOVIECODE,    ALIAS=MCOD,        FORMAT=A6, INDEX=I, $
FIELDNAME=COPY,         ALIAS=COPY,        FORMAT=I2,          $
FIELDNAME=RETURNDATE,   ALIAS=INDATE,      FORMAT=YMD,         $
FIELDNAME=FEE,          ALIAS=FEE,         FORMAT=F5.2S,       $
    
```

VIDEOTR2 Structure Diagram

```

SECTION 01
    STRUCTURE OF FOCUS      FILE VIDEOTR2 ON 05/15/03 AT 16.45.48

        CUST
    01      S1
    *****
    *CUSTID      **
    *LASTNAME    **
    *FIRSTNAME   **
    *EXPDATE     **
    *            **
    *****
    *****
        I
        I
        I
        I TRANSDAT
    02      I SH1
    *****
    *TRANSDATE   **
    *            **
    *            **
    *            **
    *            **
    *****
    *****
        I
        +-----+
        I              I
        I SALES        I RENTALS
    03      I S2          04      I S2
    *****          *****
    *TRANSCODE   **    *MOVIECODE   **I
    
```

```

*QUANTITY    **    *COPY          **
*TRANSTOT    **    *RETURNDATE   **
*            **    *FEE           **
*            **    *            **
*****      *****
*****      *****

```

Gotham Grinds Data Sources

Gotham Grinds is a group of data sources that contain sample data about a specialty items company.

- GGDEMOG contains demographic information about the customers of Gotham Grinds, a company that sells specialty items like coffee, gourmet snacks, and gifts. It consists of one segment, DEMOG01.
- GGORDER contains order information for Gotham Grinds. It consists of two segments, ORDER01 and ORDER02.
- GGPRODS contains product information for Gotham Grinds. It consists of one segment, PRODS01.
- GGSALES contains sales information for Gotham Grinds. It consists of one segment, SALES01.
- GGSTORES contains information for each of Gotham Grinds 12 stores in the United States. It consists of one segment, STORES01.

GGDEMOG Master File

```

FILENAME=GGDEMOG, SUFFIX=FOC
SEGNAME=DEMOG01, SEGTYPE=S1
FIELD=ST, ALIAS=E02, FORMAT=A02, INDEX=I, TITLE='State',
DESC='State', $
FIELD=HH, ALIAS=E03, FORMAT=I09, TITLE='Number of Households',
DESC='Number of Households', $
FIELD=AVGHHSZ98, ALIAS=E04, FORMAT=I09, TITLE='Average Household Size',
DESC='Average Household Size', $
FIELD=MEDHHI98, ALIAS=E05, FORMAT=I09, TITLE='Median Household

```

```

Income',
  DESC='Median Household Income', $
  FIELD=AVGHHI98, ALIAS=E06, FORMAT=I09, TITLE='Average Household
Income',
  DESC='Average Household Income', $
  FIELD=MALEPOP98, ALIAS=E07, FORMAT=I09, TITLE='Male Population',
  DESC='Male Population', $
  FIELD=FEMPOP98, ALIAS=E08, FORMAT=I09, TITLE='Female Population',
  DESC='Female Population', $
  FIELD=P15T01998, ALIAS=E09, FORMAT=I09, TITLE='15 to 19',
  DESC='Population 15 to 19 years old', $
  FIELD=P20T02998, ALIAS=E10, FORMAT=I09, TITLE='20 to 29',
  DESC='Population 20 to 29 years old', $
  FIELD=P30T04998, ALIAS=E11, FORMAT=I09, TITLE='30 to 49',
  DESC='Population 30 to 49 years old', $
  FIELD=P50T06498, ALIAS=E12, FORMAT=I09, TITLE='50 to 64',
  DESC='Population 50 to 64 years old', $
  FIELD=P650VR98, ALIAS=E13, FORMAT=I09, TITLE='65 and over',
  DESC='Population 65 and over', $

```

GGDEMOG Structure Diagram

```

SECTION 01
  STRUCTURE OF FOCUS      FILE GGDEMOG  ON 05/15/03 AT 12.26.05

      GGDEMOG
01      S1
*****
*ST          **I
*HH          **
*AVGHHSZ98   **
*MEDHHI98    **
*            **
*****
*****

```

GGORDER Master File

```

FILENAME=GGORDER, SUFFIX=FOC,$
SEGNAME=ORDER01, SEGTYPE=S1,$
  FIELD=ORDER_NUMBER, ALIAS=ORDN01,  FORMAT=I6,  TITLE='Order,Number',
  DESC='Order Identification Number',$
  FIELD=ORDER_DATE,  ALIAS=DATE,  FORMAT=MDY, TITLE='Order,Date',
  DESC='Date order was placed',$
  FIELD=STORE_CODE,  ALIAS=STCD,  FORMAT=A5,  TITLE='Store,Code',
  DESC='Store Identification Code (for order)',$
  FIELD=PRODUCT_CODE, ALIAS=PCD,  FORMAT=A4,  TITLE='Product,Code',
  DESC='Product Identification Code (for order)',$
  FIELD=QUANTITY,  ALIAS=ORDUNITS, FORMAT=I8,  TITLE='Ordered,Units',
  DESC='Quantity Ordered',$
SEGNAME=ORDER02, SEGTYPE=KU, PARENT=ORDER01, CRFILE=GGPRODS, CRKEY=PCD,
CRSEG=PRODS01  ,$

```

GGORDER Structure Diagram

```

SECTION 01
  STRUCTURE OF FOCUS   FILE GGORDER   ON 05/15/03 AT 16.45.48

      GGORDER
01      S1
*****
*ORDER_NUMBER**
*ORDER_DATE  **
*STORE_CODE  **
*PRODUCT_CODE**
*           **
*****
*****
      I
      I
      I
      I ORDER02
02      I KU
.....
:PRODUCT_ID   :K
:PRODUCT_DESC:
:VENDOR_CODE  :
:VENDOR_NAME  :

```

```

:
:.....:

```

GGPRODS Master File

```

FILENAME=GGPRODS, SUFFIX=FOC
SEGNAME=PRODS01, SEGTYPE=S1
  FIELD=PRODUCT_ID, ALIAS=PCD, FORMAT=A4, INDEX=I, TITLE='Product,Code',
  DESC='Product Identification Code', $
  FIELD=PRODUCT_DESCRIPTION, ALIAS=PRODUCT, FORMAT=A16, TITLE='Product',
  DESC='Product Name', $
  FIELD=VENDOR_CODE, ALIAS=VCD, FORMAT=A4, INDEX=I, TITLE='Vendor ID',
  DESC='Vendor Identification Code', $
  FIELD=VENDOR_NAME, ALIAS=VENDOR, FORMAT=A23, TITLE='Vendor Name',
  DESC='Vendor Name', $
  FIELD=PACKAGE_TYPE, ALIAS=PACK, FORMAT=A7, TITLE='Package',
  DESC='Packaging Style', $
  FIELD=SIZE, ALIAS=SZ, FORMAT=I2, TITLE='Size',
  DESC='Package Size', $
  FIELD=UNIT_PRICE, ALIAS=UNITPR, FORMAT=D7.2, TITLE='Unit,Price',
  DESC='Price for one unit', $

```

GGPRODS Structure Diagram

```

SECTION 01
  STRUCTURE OF FOCUS      FILE GGPRODS   ON 05/15/03 AT 12.26.05

      GGPRODS
01      S1
*****
*PRODUCT_ID  **I
*PRODUCT_DESC**I
*VENDOR_CODE **
*VENDOR_NAME **
*              **
*****
*****

```

GGSales Master File

```

FILENAME=GGSales, SUFFIX=FOC
SEGNAME=SALES01, SEGTYPE=S1
  FIELD=SEQ_NO, ALIAS=SEQ, FORMAT=I5, TITLE='Sequence#',
  DESC='Sequence number in database', $
  FIELD=CATEGORY, ALIAS=E02, FORMAT=A11, INDEX=I, TITLE='Category',
  DESC='Product category', $
  FIELD=PCD, ALIAS=E03, FORMAT=A04, INDEX=I, TITLE='Product ID',
  DESC='Product Identification code (for sale)', $
  FIELD=PRODUCT, ALIAS=E04, FORMAT=A16, TITLE='Product',
  DESC='Product name', $
  FIELD=REGION, ALIAS=E05, FORMAT=A11, INDEX=I, TITLE='Region',
  DESC='Region code', $
  FIELD=ST, ALIAS=E06, FORMAT=A02, INDEX=I, TITLE='State',
  DESC='State', $
  FIELD=CITY, ALIAS=E07, FORMAT=A20, TITLE='City',
  DESC='City', $
  FIELD=STCD, ALIAS=E08, FORMAT=A05, INDEX=I, TITLE='Store ID',
  DESC='Store identification code (for sale)', $
  FIELD=DATE, ALIAS=E09, FORMAT=I8YYMD, TITLE='Date',
  DESC='Date of sales report', $
  FIELD=UNITS, ALIAS=E10, FORMAT=I08, TITLE='Unit Sales',
  DESC='Number of units sold', $
  FIELD=DOLLARS, ALIAS=E11, FORMAT=I08, TITLE='Dollar Sales',
  DESC='Total dollar amount of reported sales', $
  FIELD=BUDUNITS, ALIAS=E12, FORMAT=I08, TITLE='Budget Units',
  DESC='Number of units budgeted', $
  FIELD=BUDDOLLARS, ALIAS=E13, FORMAT=I08, TITLE='Budget Dollars',
  DESC='Total sales quota in dollars', $

```

GGSales Structure Diagram

```

SECTION 01
  STRUCTURE OF FOCUS   FILE GGSales   ON 05/15/03 AT 12.26.05

      GGSales
01      S1
*****
*SEQ_NO      **
*CATEGORY    **I
*PCD         **I

```

```
*PRODUCT      **I
*              **
*****
*****
```

GGSTORES Master File

```
FILENAME=GGSTORES, SUFFIX=FOC
SEGNAME=STORES01, SEGTYPE=S1
  FIELD=STORE_CODE, ALIAS=E02, FORMAT=A05, INDEX=I, TITLE='Store ID',
  DESC='Franchisee ID Code', $
  FIELD=STORE_NAME, ALIAS=E03, FORMAT=A23, TITLE='Store Name',
  DESC='Store Name', $
  FIELD=ADDRESS1, ALIAS=E04, FORMAT=A19, TITLE='Contact',
  DESC='Franchisee Owner', $
  FIELD=ADDRESS2, ALIAS=E05, FORMAT=A31, TITLE='Address',
  DESC='Street Address', $
  FIELD=CITY, ALIAS=E06, FORMAT=A22, TITLE='City',
  DESC='City', $
  FIELD=STATE, ALIAS=E07, FORMAT=A02, INDEX=I, TITLE='State',
  DESC='State', $
  FIELD=ZIP, ALIAS=E08, FORMAT=A06, TITLE='Zip Code',
  DESC='Postal Code', $
```

GGSTORES Structure Diagram

```
SECTION 01
  STRUCTURE OF FOCUS      FILE GGSTORES ON 05/15/03 AT 12.26.05

      GGSTORES
01      S1
*****
*STORE_CODE  **I
*STORE_NAME  **
*ADDRESS1    **
*ADDRESS2    **
*            **
*****
*****
```

Century Corp Data Sources

Century Corp is a consumer electronics manufacturer that distributes products through retailers around the world. Century Corp has thousands of employees in plants, warehouses, and offices worldwide. Their mission is to provide quality products and services to their customers.

Century Corp is a group of data sources that contain financial, human resources, inventory, and order information. The last three data sources are designed to be used with charts of accounts data.

- CENTCOMP Master File contains location information for stores. It consists of one segment, COMPINFO.
- CENTFIN Master File contains financial information. It consists of one segment, ROOT_SEG.
- CENTHR Master File contains human resources information. It consists of one segment, EMPSEG.
- CENTINV Master File contains inventory information. It consists of one segment, INVINFO.
- CENTORD Master File contains order information. It consists of four segments, OINFO, STOSEG, PINFO, and INVSEG.
- CENTQA Master File contains problem information. It consists of three segments, PROD_SEG, INVSEG, and PROB_SEG.
- CENTGL Master File contains a chart of accounts hierarchy. The field GL_ACCOUNT_PARENT is the parent field in the hierarchy. The field GL_ACCOUNT is the hierarchy field. The field GL_ACCOUNT_CAPTION can be used as the descriptive caption for the hierarchy field.
- CENTSYSF Master File contains detail-level financial data. CENTSYSF uses a different account line system (SYS_ACCOUNT), which can be joined to the SYS_ACCOUNT field in CENTGL. Data uses "natural" signs (expenses are positive, revenue negative).
- CENTSTMT Master File contains detail-level financial data and a cross-reference to the CENTGL data source.

CENTCOMP Master File

```

FILE=CENTCOMP, SUFFIX=FOC, FDFC=19, FYRT=00
  SEGNAME=COMPINFO, SEGTYPE=S1, $
  FIELD=STORE_CODE, ALIAS=SNUM, FORMAT=A6, INDEX=I,
  TITLE='Store Id#:',
  DESCRIPTION='Store Id#', $
  FIELD=STORENAME, ALIAS=SNAME, FORMAT=A20,
  WITHIN=STATE,
  TITLE='Store,Name:',
  DESCRIPTION='Store Name', $
  FIELD=STATE, ALIAS=STATE, FORMAT=A2,
  WITHIN=PLANT,
  TITLE='State:',
  DESCRIPTION=State, $
  DEFINE REGION/A5=DECODE STATE ('AL' 'SOUTH' 'AK' 'WEST' 'AR' 'SOUTH'
  'AZ' 'WEST' 'CA' 'WEST' 'CO' 'WEST' 'CT' 'EAST'
  'DE' 'EAST' 'DC' 'EAST' 'FL' 'SOUTH' 'GA' 'SOUTH' 'HI' 'WEST'
  'ID' 'WEST' 'IL' 'NORTH' 'IN' 'NORTH' 'IA' 'NORTH'
  'KS' 'NORTH' 'KY' 'SOUTH' 'LA' 'SOUTH' 'ME' 'EAST' 'MD' 'EAST'
  'MA' 'EAST' 'MI' 'NORTH' 'MN' 'NORTH' 'MS' 'SOUTH' 'MT' 'WEST'
  'MO' 'SOUTH' 'NE' 'WEST' 'NV' 'WEST' 'NH' 'EAST' 'NJ' 'EAST'
  'NM' 'WEST' 'NY' 'EAST' 'NC' 'SOUTH' 'ND' 'NORTH' 'OH' 'NORTH'
  'OK' 'SOUTH' 'OR' 'WEST' 'PA' 'EAST' 'RI' 'EAST' 'SC' 'SOUTH'
  'SD' 'NORTH' 'TN' 'SOUTH' 'TX' 'SOUTH' 'UT' 'WEST' 'VT' 'EAST'
  'VA' 'SOUTH' 'WA' 'WEST' 'WV' 'SOUTH' 'WI' 'NORTH' 'WY' 'WEST'
  'NA' 'NORTH' 'ON' 'NORTH' ELSE ' ');,
  TITLE='Region:',
  DESCRIPTION=Region, $

```

CENTCOMP Structure Diagram

```

SECTION 01
  STRUCTURE OF FOCUS      FILE CENTCOMP ON 05/15/03 AT 10.20.49

      COMPINFO
01      S1
*****
*STORE_CODE  **I
*STORENAME   **
*STATE       **
*            **

```

```

*                **
*****
*****

```

CENTFIN Master File

```

FILE=CENTFIN, SUFFIX=FOC, FDFC=19, FYRT=00
  SEGNAME=ROOT_SEG, SEGTYPE=S4, $
  FIELD=YEAR, ALIAS=YEAR, FORMAT=YY,
    WITHIN='*Time Period', $
  FIELD=QUARTER, ALIAS=QTR, FORMAT=Q,
    WITHIN=YEAR,
    TITLE=Quarter,
    DESCRIPTION=Quarter, $
  FIELD=MONTH, ALIAS=MONTH, FORMAT=M,
    TITLE=Month,
    DESCRIPTION=Month, $
  FIELD=ITEM, ALIAS=ITEM, FORMAT=A20,
    TITLE=Item,
    DESCRIPTION=Item, $
  FIELD=VALUE, ALIAS=VALUE, FORMAT=D12.2,
    TITLE=Value,
    DESCRIPTION=Value, $
  DEFINE ITYPE/A12=IF EDIT(ITEM,'9$$$$$$$$$$$$$$$$') EQ 'E'
    THEN 'Expense' ELSE IF EDIT(ITEM,'9$$$$$$$$$$$$$$$$') EQ 'R'
    THEN 'Revenue' ELSE 'Asset';,
    TITLE=Type,
    DESCRIPTION='Type of Financial Line Item',$
  DEFINE MOTEXT/MT=MONTH;,$

```

CENTFIN Structure Diagram

```

SECTION 01
  STRUCTURE OF FOCUS      FILE CENTFIN  ON 05/15/03 AT 10.25.52

      ROOT_SEG
01      S4
*****
*YEAR      **

```

```

*QUARTER      **
*MONTH        **
*ITEM         **
*             **
*****
*****

```

CENTHR Master File

```

FILE=CENTHR, SUFFIX=FOC
  SEGNAME=EMPSEG, SEGTYPE=S1, $
  FIELD=ID_NUM, ALIAS=ID#, FORMAT=I9,
  TITLE='Employee, ID#',
  DESCRIPTION='Employee Identification Number', $
  FIELD=LNAME, ALIAS=LN, FORMAT=A14,
  TITLE='Last, Name',
  DESCRIPTION='Employee Last Name', $
  FIELD=FNAME, ALIAS=FN, FORMAT=A12,
  TITLE='First, Name',
  DESCRIPTION='Employee First Name', $
  FIELD=PLANT, ALIAS=PLT, FORMAT=A3,
  TITLE='Plant, Location',
  DESCRIPTION='Location of the manufacturing plant',
  WITHIN='*Location', $
  FIELD=START_DATE, ALIAS=SDATE, FORMAT=YYMD,
  TITLE='Starting, Date',
  DESCRIPTION='Date of employment', $
  FIELD=TERM_DATE, ALIAS=TERM_DATE, FORMAT=YYMD,
  TITLE='Termination, Date',
  DESCRIPTION='Termination Date', $
  FIELD=STATUS, ALIAS=STATUS, FORMAT=A10,
  TITLE='Current, Status',
  DESCRIPTION='Job Status', $
  FIELD=POSITION, ALIAS=JOB, FORMAT=A2,
  TITLE=Position,
  DESCRIPTION='Job Position', $
  FIELD=PAYSCALE, ALIAS=PAYLEVEL, FORMAT=I2,
  TITLE='Pay, Level',
  DESCRIPTION='Pay Level',
  WITHIN='*Wages', $
  DEFINE POSITION_DESC/A17=IF POSITION EQ 'BM' THEN
    'Plant Manager' ELSE
    IF POSITION EQ 'MR' THEN 'Line Worker' ELSE

```

```
IF POSITION EQ 'TM' THEN 'Line Manager' ELSE
'Technician';
TITLE='Position,Description',
DESCRIPTION='Position Description',
WITHIN='PLANT',$
DEFINE BYEAR/YY=START_DATE;
TITLE='Beginning,Year',
DESCRIPTION='Beginning Year',
WITHIN='*Starting Time Period',$
```

```
DEFINE BQUARTER/Q=START_DATE;
TITLE='Beginning,Quarter',
DESCRIPTION='Beginning Quarter',
WITHIN='BYEAR',
DEFINE BMONTH/M=START_DATE;
TITLE='Beginning,Month',
DESCRIPTION='Beginning Month',
WITHIN='BQUARTER',$
DEFINE EYEAR/YY=TERM_DATE;
TITLE='Ending,Year',
DESCRIPTION='Ending Year',
WITHIN='*Termination Time Period',$
DEFINE EQUARTER/Q=TERM_DATE;
TITLE='Ending,Quarter',
DESCRIPTION='Ending Quarter',
WITHIN='EYEAR',$
DEFINE EMONTH/M=TERM_DATE;
TITLE='Ending,Month',
DESCRIPTION='Ending Month',
WITHIN='EQUARTER',$
DEFINE RESIGN_COUNT/I3=IF STATUS EQ 'RESIGNED' THEN 1
ELSE 0;
TITLE='Resigned,Count',
DESCRIPTION='Resigned Count',$
DEFINE FIRE_COUNT/I3=IF STATUS EQ 'TERMINAT' THEN 1
ELSE 0;
TITLE='Terminated,Count',
DESCRIPTION='Terminated Count',$
DEFINE DECLINE_COUNT/I3=IF STATUS EQ 'DECLINED' THEN 1
ELSE 0;
TITLE='Declined,Count',
DESCRIPTION='Declined Count',$
DEFINE EMP_COUNT/I3=IF STATUS EQ 'EMPLOYED' THEN 1
ELSE 0;
TITLE='Employed,Count',
DESCRIPTION='Employed Count',$
```

```

DEFINE PEND_COUNT/I3=IF STATUS EQ 'PENDING' THEN 1
  ELSE 0;
  TITLE='Pending,Count',
  DESCRIPTION='Pending Count',\$
DEFINE REJECT_COUNT/I3=IF STATUS EQ 'REJECTED' THEN 1
  ELSE 0;
  TITLE='Rejected,Count',
  DESCRIPTION='Rejected Count',\$
DEFINE FULLNAME/A28=LNAME||', '|FNAME;
  TITLE='Full Name',
  DESCRIPTION='Full Name: Last, First', WITHIN='POSITION_DESC',\$

```

```

DEFINE SALARY/D12.2=IF BMONTH LT 4 THEN PAYLEVEL * 12321
  ELSE IF BMONTH GE 4 AND BMONTH LT 8 THEN PAYLEVEL * 13827
  ELSE PAYLEVEL * 14400;;
  TITLE='Salary',
  DESCRIPTION='Salary',\$
DEFINE PLANTLNG/A11=DECODE PLANT (BOS 'Boston' DAL 'Dallas'
  LA 'Los Angeles' ORL 'Orlando' SEA 'Seattle' STL 'St Louis'
  ELSE 'n/a');\$

```

CENTHR Structure Diagram

SECTION 01

STRUCTURE OF FOCUS FILE CENTHR ON 05/15/03 AT 10.40.34

```

          EMPSEG
01      S1
*****
*ID_NUM      **
*LNAME       **
*FNAME       **
*PLANT       **
*            **
*****
*****

```

CENTINV Master File

```

FILE=CENTINV, SUFFIX=FOC, FDFC=19, FYRT=00
SEGNAME=INVINFO, SEGTYPE=S1, $
  FIELD=PROD_NUM, ALIAS=PNUM, FORMAT=A4, INDEX=I,
  TITLE='Product,Number:',
  DESCRIPTION='Product Number', $
  FIELD=PRODNAME, ALIAS=PNAME, FORMAT=A30,
  WITHIN=PRODCAT,
  TITLE='Product,Name:',
  DESCRIPTION='Product Name', $
  FIELD=QTY_IN_STOCK, ALIAS=QIS, FORMAT=I7,
  TITLE='Quantity,In Stock:',
  DESCRIPTION='Quantity In Stock', $
  FIELD=PRICE, ALIAS=RETAIL, FORMAT=D10.2,
  TITLE='Price:',
  DESCRIPTION=Price, $
  FIELD=COST, ALIAS=OUR_COST, FORMAT=D10.2,
  TITLE='Our,Cost:',
  DESCRIPTION='Our Cost:', $
  DEFINE PRODCAT/A22 = IF PRODNAME CONTAINS 'LCD'
  THEN 'VCRs' ELSE IF PRODNAME
  CONTAINS 'DVD' THEN 'DVD' ELSE IF PRODNAME CONTAINS 'Camcor'
  THEN 'Camcorders'
  ELSE IF PRODNAME CONTAINS 'Camera' THEN 'Cameras' ELSE IF PRODNAME
  CONTAINS 'CD' THEN 'CD Players'
  ELSE IF PRODNAME CONTAINS 'Tape' THEN 'Digital Tape Recorders'
  ELSE IF PRODNAME CONTAINS 'Combo' THEN 'Combo Players'
  ELSE 'PDA Devices'; WITHIN=PRODTYPE, TITLE='Product Category:', $
  DEFINE PRODTYPE/A19 = IF PRODNAME CONTAINS 'Digital' OR 'DVD' OR 'QX'
  THEN 'Digital' ELSE 'Analog';,WITHIN='*Product Dimension',
  TITLE='Product Type:', $

```

CENTINV Structure Diagram

```

SECTION 01
  STRUCTURE OF FOCUS      FILE CENTINV  ON 05/15/03 AT 10.43.35

      INVINFO
01      S1
*****
*PROD_NUM      **I

```

```
*PRODNAME      **
*QTY_IN_STOCK**
*PRICE         **
*              **
*****
*****
```

CENTORD Master File

```
FILE=CENTORD, SUFFIX=FOC
SEGNAME=OINFO, SEGTYPE=S1, $
  FIELD=ORDER_NUM, ALIAS=ONUM, FORMAT=A5, INDEX=I,
  TITLE='Order,Number:',
  DESCRIPTION='Order Number', $
  FIELD=ORDER_DATE, ALIAS=ODATE, FORMAT=YYMD,
  TITLE='Date,Of Order:',
  DESCRIPTION='Date Of Order', $
  FIELD=STORE_CODE, ALIAS=SNUM, FORMAT=A6, INDEX=I,
  TITLE='Company ID#:',
  DESCRIPTION='Company ID#', $
  FIELD=PLANT, ALIAS=PLNT, FORMAT=A3, INDEX=I,
  TITLE='Manufacturing,Plant',
  DESCRIPTION='Location Of Manufacturing Plant',
  WITHIN='*Location', $
  DEFINE YEAR/YY=ORDER_DATE;,
  WITHIN='*Time Period', $
  DEFINE QUARTER/Q=ORDER_DATE;,
  WITHIN='YEAR', $
  DEFINE MONTH/M=ORDER_DATE;,
  WITHIN='QUARTER', $
SEGNAME=PINFO, SEGTYPE=S1, PARENT=OINFO, $
  FIELD=PROD_NUM, ALIAS=PNUM, FORMAT=A4, INDEX=I,
  TITLE='Product,Number#:',
  DESCRIPTION='Product Number#', $
  FIELD=QUANTITY, ALIAS=QTY, FORMAT=I8C,
  TITLE='Quantity:',
  DESCRIPTION=Quantity, $
  FIELD=LINEPRICE, ALIAS=LINETOTAL, FORMAT=D12.2MC,
  TITLE='Line,Total',
  DESCRIPTION='Line Total', $
  DEFINE LINE_COGS/D12.2=QUANTITY*COST;,
  TITLE='Line,Cost Of,Goods Sold',
  DESCRIPTION='Line cost of goods sold', $
```



```

DEFINE PLANTLNG/A11=DECODE PLANT (BOS 'Boston' DAL 'Dallas'
  LA 'Los Angeles' ORL 'Orlando' SEA 'Seattle' STL 'St Louis'
  ELSE 'n/a');
SEGNAME=INVSEG, SEGTYPE=DKU, PARENT=PINFO, CRFILE=CENTINV,
  CRKEY=PROD_NUM, CRSEG=INVINFO,$
SEGNAME=STOSEG, SEGTYPE=DKU, PARENT=OINFO, CRFILE=CENTCOMP,
  CRKEY=STORE_CODE, CRSEG=COMPINFO,$

```

CENTORD Structure Diagram

```

SECTION 01
  STRUCTURE OF FOCUS      FILE CENTORD   ON 05/15/03 AT 10.17.52

      OINFO
01      S1
*****
*ORDER_NUM    **I
*STORE_CODE   **I
*PLANT        **I
*ORDER_DATE   **
*              **
*****
      I
      +-----+
      I              I
      I STOSEG      I PINFO
02      I KU        03      I S1
.....          *****
:STORE_CODE   :K   *PROD_NUM    **I
:STORENAME    :   *QUANTITY     **
:STATE        :   *LINEPRICE    **
:              :   *              **
:              :   *              **
:.....:          *****
JOINED  CENTCOMP *****
              I
              I
              I
              I INVSEG
              04      I KU
.....
:PROD_NUM    :K

```

```

:PRODNAME      :
:QTY_IN_STOCK:
:PRICE         :
:              :
:.....:
JOINED  CENTINV

```

CENTQA Master File

```

FILE=CENTQA, SUFFIX=FOC, FDFC=19, FYRT=00
SEGNAME=PROD_SEG, SEGTYPE=S1, $
  FIELD=PROD_NUM, ALIAS=PNUM, FORMAT=A4, INDEX=I,
  TITLE='Product,Number',
  DESCRIPTION='Product Number', $
SEGNAME=PROB_SEG, PARENT=PROD_SEG, SEGTYPE=S1, $
  FIELD=PROBNUM, ALIAS=PROBNO, FORMAT=I5,
  TITLE='Problem,Number',
  DESCRIPTION='Problem Number',
  WITHIN=PLANT,$
  FIELD=PLANT, ALIAS=PLT, FORMAT=A3, INDEX=I,
  TITLE=Plant,
  DESCRIPTION=Plant,
  WITHIN=PROBLEM_LOCATION,$
  FIELD=PROBLEM_DATE, ALIAS=PDATE, FORMAT=YYMD,
  TITLE='Date,Problem,Reported',
  DESCRIPTION='Date Problem Was Reported', $
  FIELD=PROBLEM_CATEGORY, ALIAS=PROBCAT, FORMAT=A20, $
  TITLE='Problem,Category',
  DESCRIPTION='Problem Category',
  WITHIN=*Problem,$
  FIELD=PROBLEM_LOCATION, ALIAS=PROBLOC, FORMAT=A10,
  TITLE='Location,Problem,Occurred',
  DESCRIPTION='Location Where Problem Occurred',
  WITHIN=PROBLEM_CATEGORY,$
DEFINE PROB_YEAR/YY=PROBLEM_DATE;,
  TITLE='Year,Problem,Occurred',
  DESCRIPTION='Year Problem Occurred',
  WITHIN=*Time Period,$
DEFINE PROB_QUARTER/Q=PROBLEM_DATE;
  TITLE='Quarter,Problem,Occurred',
  DESCRIPTION='Quarter Problem Occurred',
  WITHIN=PROB_YEAR,$
DEFINE PROB_MONTH/M=PROBLEM_DATE;

```

```

TITLE='Month,Problem,Occurred',
DESCRIPTION='Month Problem Occurred',
WITHIN=PROB_QUARTER,$
DEFINE PROBLEM_OCCUR/I5 WITH PROBNUM=1;,
TITLE='Problem,Occurrence'
DESCRIPTION='# of times a problem occurs',$
DEFINE PLANTLNG/A11=DECODE PLANT (BOS 'Boston' DAL 'Dallas'
LA 'Los Angeles' ORL 'Orlando' SEA 'Seattle' STL 'St Louis'
ELSE 'n/a');$
SEGNAME=INVSEG, SEGTYPE=DKU, PARENT=PROD_SEG, CRFILE=CENTINV,
CRKEY=PROD_NUM, CRSEG=INVINFO,$
    
```

CENTQA Structure Diagram

SECTION 01

STRUCTURE OF FOCUS

FILE CENTQA

ON 05/15/03 AT 10.46.43

```

          PROD_SEG
01      S1
*****
*PROD_NUM  **I
*          **
*          **
*          **
*          **
*****
*****
          I
          +-----+
          I          I
          I INVSEG   I PROB_SEG
02      I KU          03      I S1
.....
:PROD_NUM   :K      *PROBNUM   **
:PRODNAME   :      *PLANT     **I
:QTY_IN_STOCK:    *PROBLEM_DATE**
:PRICE      :      *PROBLEM_CAT>**
:           :      *          **
:.....:      *****
JOINED CENTINV *****
    
```

CENTGL Master File

```

FILE=CENTGL ,SUFFIX=FOC
SEGNAME=ACCOUNTS, SEGTYPE=S1
  FIELDNAME=GL_ACCOUNT, ALIAS=GLACCT, FORMAT=A7,
  TITLE='Ledger,Account', FIELDTYPE=I, $
  FIELDNAME=GL_ACCOUNT_PARENT, ALIAS=GLPAR, FORMAT=A7,
  TITLE=Parent,
  PROPERTY=PARENT_OF, REFERENCE=GL_ACCOUNT, $
  FIELDNAME=GL_ACCOUNT_TYPE, ALIAS=GLTYPE, FORMAT=A1,
  TITLE=Type,$
  FIELDNAME=GL_ROLLUP_OP, ALIAS=GLROLL, FORMAT=A1,
  TITLE=Op, $
  FIELDNAME=GL_ACCOUNT_LEVEL, ALIAS=GLLEVEL, FORMAT=I3,
  TITLE=Lev, $
  FIELDNAME=GL_ACCOUNT_CAPTION, ALIAS=GLCAP, FORMAT=A30,
  TITLE=Caption,
  PROPERTY=CAPTION, REFERENCE=GL_ACCOUNT, $
  FIELDNAME=SYS_ACCOUNT, ALIAS=ALINE, FORMAT=A6,
  TITLE='System,Account,Line', MISSING=ON, $

```

CENTGL Structure Diagram

```

SECTION 01
  STRUCTURE OF FOCUS      FILE CENTGL      ON 05/15/03 AT 15.18.48

      ACCOUNTS
01      S1
*****
*GL_ACCOUNT  **I
*GL_ACCOUNT_>**
*GL_ACCOUNT_>**
*GL_ROLLUP_OP**
*              **
*****
*****

```

CENTSYSF Master File

```

FILE=CENTSYSF ,SUFFIX=FOC
SEGNAME=RAWDATA ,SEGTYPE=S2
  FIELDNAME = SYS_ACCOUNT , ,A6 , FIELDTYPE=I,
  TITLE='System,Account,Line', $
  FIELDNAME = PERIOD , ,YYM , FIELDTYPE=I,$
  FIELDNAME = NAT_AMOUNT , ,D10.0 , TITLE='Month,Actual', $
  FIELDNAME = NAT_BUDGET , ,D10.0 , TITLE='Month,Budget', $
  FIELDNAME = NAT_YTDAMT , ,D12.0 , TITLE='YTD,Actual', $
  FIELDNAME = NAT_YTDBUD , ,D12.0 , TITLE='YTD,Budget', $

```

CENTSYSF Structure Diagram

```

SECTION 01
  STRUCTURE OF FOCUS   FILE CENTSYSF   ON 05/15/03 AT 15.19.27

      RAWDATA
01      S2
*****
*SYS_ACCOUNT **I
*PERIOD      **I
*NAT_AMOUNT  **
*NAT_BUDGET  **
*            **
*****
*****

```

CENTSTMT Master File

```

FILE=CENTSTMT, SUFFIX=FOC
SEGNAME=ACCOUNTS, SEGTYPE=S1
  FIELD=GL_ACCOUNT, ALIAS=GLACCT, FORMAT=A7,
  TITLE='Ledger,Account', FIELDTYPE=I, $
  FIELD=GL_ACCOUNT_PARENT, ALIAS=GLPAR, FORMAT=A7,
  TITLE=Parent,
  PROPERTY=PARENT_OF, REFERENCE=GL_ACCOUNT, $
  FIELD=GL_ACCOUNT_TYPE, ALIAS=GLTYPE, FORMAT=A1,

```

```

TITLE=Type,$
FIELD=GL_ROLLUP_OP, ALIAS=GLROLL, FORMAT=A1,
TITLE=Op, $
FIELD=GL_ACCOUNT_LEVEL, ALIAS=GLLEVEL, FORMAT=I3,
TITLE=Lev, $
FIELD=GL_ACCOUNT_CAPTION, ALIAS=GLCAP, FORMAT=A30,
TITLE=Caption,
PROPERTY=CAPTION, REFERENCE=GL_ACCOUNT, $
SEGNAME=CONSOL, SEGTYPE=S1, PARENT=ACCOUNTS, $
FIELD=PERIOD, ALIAS=MONTH, FORMAT=YYM, $
FIELD=ACTUAL_AMT, ALIAS=AA, FORMAT=D10.0, MISSING=ON,
TITLE='Actual', $
FIELD=BUDGET_AMT, ALIAS=BA, FORMAT=D10.0, MISSING=ON,
TITLE='Budget', $
FIELD=ACTUAL_YTD, ALIAS=AYTD, FORMAT=D12.0, MISSING=ON,
TITLE='YTD,Actual', $
FIELD=BUDGET_YTD, ALIAS=BYTD, FORMAT=D12.0, MISSING=ON,
TITLE='YTD,Budget', $

```

CENTSTMT Structure Diagram

SECTION 01

STRUCTURE OF FOCUS FILE CENTSTMT ON 05/15/03 AT 14.45.44

```

          ACCOUNTS
01      S1
*****
*GL_ACCOUNT  **I
*GL_ACCOUNT_>**
*GL_ACCOUNT_>**
*GL_ROLLUP_OP**
*           **
*****
*****
          I
          I
          I
          I CONSOL
02      I S1
*****
*PERIOD      **
*ACTUAL_AMT  **
*BUDGET_AMT  **

```

```
*ACTUAL_YTD **
*           **
*****
*****
```

CENTGLL Master File

```
FILE=CENTGLL      ,SUFFIX=FOC
SEGNAME=ACCOUNTS ,SEGTYPE=S01
FIELDNAME=GL_ACCOUNT, ALIAS=GLACCT, FORMAT=A7,
                    TITLE='Ledger,Account', FIELDTYPE=I, $
FIELDNAME=GL_ACCOUNT_PARENT, ALIAS=GLPAR, FORMAT=A7,
                    TITLE=Parent,
                    PROPERTY=PARENT_OF, REFERENCE=GL_ACCOUNT, $
FIELDNAME=GL_ACCOUNT_TYPE, ALIAS=GLTYPE, FORMAT=A1,
                    TITLE=Type,$
FIELDNAME=GL_ROLLUP_OP, ALIAS=GLROLL, FORMAT=A1,
                    TITLE=Op, $
FIELDNAME=GL_ACCOUNT_LEVEL, ALIAS=GLLEVEL, FORMAT=I3,
                    TITLE=Lev, $
FIELDNAME=GL_ACCOUNT_CAPTION, ALIAS=GLCAP, FORMAT=A30,
                    TITLE=Caption,
                    PROPERTY=CAPTION, REFERENCE=GL_ACCOUNT, $
FIELDNAME=SYS_ACCOUNT, ALIAS=ALINE, FORMAT=A6,
                    TITLE='System,Account,Line', MISSING=ON, $
```

CENTGLL Structure Diagram

```
SECTION 01
      STRUCTURE OF FOCUS      FILE CENTGLL ON 05/15/03 AT 14.45.44

      ACCOUNTS
01      S1
*****
*GL_ACCOUNT **I
*GL_ACCOUNT_>**
*GL_ACCOUNT_>**
*GL_ROLLUP_OP**
*           **
```

Error Messages

To see the text or explanation for any error message, you can display it online in your FOCUS session or find it in a standard FOCUS ERRORS file. All of the FOCUS error messages are stored in eight system ERRORS files.

- For z/OS, the ddname is ERRORS.

Displaying Messages

To display the text and explanation for any message, issue the following query command at the FOCUS command level

```
? n
```

where:

n

Is the message number.

The message number and text appear, along with a detailed explanation of the message (if one exists). For example, issuing the following command

```
? 210
```

displays the following:

```
(FOC210)          THE DATA VALUE HAS A FORMAT ERROR:  
An alphabetic character has been found where all numerical digits are  
required.
```

Table Syntax Summary and Limits

This appendix summarizes FOCUS reporting commands and options.

TABLE Syntax Summary

The syntax of a TABLE request is:

```

DEFINE FILE filename      CLEAR|ADD
tempfield  [/format] [{DEFCENT|DFC} {cc|19} {YRTHRESH|YRT} {[ -]yy|0}]
           [MISSING {ON|OFF} [NEEDS] {SOME|ALL} [DATA]]
           [(GEOGRAPHIC_ROLE = georole)] [WITH realfield]
           [TITLE 'line1[,line2 ...']]
           [DESCRIPTION 'description'] = expression;
tempfield  [/format]      REDEFINES qualifier.fieldname = expression;
.
.
.
END
TABLE FILE filename
HEADING [CENTER]
"text"
{display_command} [SEG.] field  [/R|/L|/C] [/format]
{display_command} [prefixop.] [field] [/R|/L|/C] [/format]
  [NOPRINT|AS 'title1,...,title5'] [AND|OVER] [obj2...obj1024]
  [WITHIN field] [IN [+]n]
COMPUTE field  [/format] [(GEOGRAPHIC_ROLE = georole)] =
  expression; [AS 'title,...,title5'] [IN [+]n]
[AND] ROW-TOTAL  [/R|/L|/C] [/format][AS 'name']
[AND] COLUMN-TOTAL  [/R|/L|/C] [AS 'name']
ACROSS [HIGHEST] sortfieldn [IN-GROUPS-OF qty]
  [NOPRINT| AS 'title1,...,title5']
BY [HIGHEST] sortfieldn [IN-GROUPS-OF qty]
  [NOPRINT| AS 'title1,...,title5']
BY [HIGHEST|LOWEST{n}] TOTAL [prefix_operator] {field|code_value}
RANKED [AS 'name'] BY {TOP|HIGHEST|LOWEST} [n] field
  [PLUS OTHERS AS 'othertext']
  [IN-GROUPS-OF qty [TILES [TOP m]] [AS 'heading']]
  [NOPRINT|AS 'title1,...,title5']

```

```
{BY|ACROSS} sortfield IN-RANGES-OF value [TOP limit]
ON sfld option1 [AND] option2 [WHEN expression;...]
ON sfld RECAP fld1 [/fmt] = FORECAST (fld2, intvl, npredct,
  '{MOVAVE|EXPAVE}', npnt);
```

```
ON sfld RECAP fld1[/fmt] = FORECAST(fld2, interval, npredict,
  'DOUBLEXP',
  npoint1, npoint2);
```

```
ON sfld RECAP fld1[/fmt] = FORECAST(fld2, interval, npredict,
  'SEASONAL',
  nperiod, npoint1, npoint2, npoint3);
```

```
ON sfld RECAP fld1 [/fmt] = FORECAST (fld2, intvl, npredct,
  'REGRESS');
```

```
ON {sortfield|TABLE} RECAP y[/fmt] = REGRESS(n, x1, [x2, [x3,]] z);
ON sfld RECAP fld1 [/fmt] = FORECAST (infield, interval, npredict,
  'DOUBLEXP', npoint, npoint2);
ON sfld RECAP fld1 [/fmt] = FORECAST (infield, interval, npredict,
  'SEASONAL', nperiod, npoint, npoint2, npoint3);{BY|ON} fieldname
SUBHEAD
  [NEWPAGE]
"text"
```

```
{BY|ON} fieldname SUBFOOT [WITHIN] [MULTILINES][NEWPAGE]
"text" [<prefop.fieldname ... ]" [WHEN expression;]
```

```
WHERE [TOTAL] expression
WHERE {RECORDLIMIT|READLIMIT} EQ n
IF [TOTAL] field relation value [OR value...]
WHERE_GROUPED expression
ON TABLE SET parameter value
ON TABLE HOLD [VIA program][AS name] [FORMAT format] [DATASET dataset]
  [MISSING {ON|OFF}] [PERSISTENCE {STAGE|PERMANENT}]
ON TABLE {PCHOLD|SAVE|SAVB} [AS name] [FORMAT format] [MISSING
{ON|OFF}]
ON TABLE NOTOTAL
ON TABLE COLUMN-TOTAL [/R|/L|/C] [AS 'name'] fieldname
ON TABLE {ROW-TOTAL|ACROSS-TOTAL}[/R|/L|/C][format] [AS 'name'] fldname
{BY|ON} sfld [AS 'text1'] {SUBTOTAL|SUB-TOTAL|SUMMARIZE|RECOMPUTE}
```

```

[MULTILINES] [pref. ] [field1 [pref. ] field2 ...] [AS 'text2']
[WHEN expression;]
{ACROSS|ON} sfld [AS 'text1'] {SUBTOTAL|SUB-TOTAL|SUMMARIZE|RECOMPUTE}
  [AS 'text2'] [COLUMNS c1 [AND c2 ...]]
ON TABLE {SUBTOTAL|SUB-TOTAL|SUMMARIZE|RECOMPUTE}
  [pref. ] [field1 [pref. ] field2 ...] [AS 'text2']
FOOTING [CENTER] [BOTTOM]
"text"
MORE
FILE file2
  [IF field relation value [OR value...]|WHERE expression]
{END|RUN|QUIT}

```

Hierarchical Reporting Syntax Summary

```

SUM [FROLL.]measure_field ...
BY hierarchy_field [HIERARCHY [WHEN expression_using_hierarchy_fields;]
  [SHOW [TOP|UP n] [TO {BOTTOM|DOWN m}] [byoption [WHEN condition] ...]
]
[WHERE expression_using_dimension_data]
[ON hierarchy_field HIERARCHY [WHEN expression_using_hierarchy_fields;]
  [SHOW [TOP|UP n] [TO BOTTOM|DOWN m] [byoption [WHEN condition] ...]]

```

TABLEF Syntax Summary

The syntax of a TABLEF request is:

```

TABLEF FILE filename
HEADING [CENTER]
"text"

```

```

{display_command} [SEG.]field [/R|/L|/C] [/format]
{display_command} [prefixop.][field] [/R|/L|/C] [/format]
  [NOPRINT|AS 'title1,...,title5'] [AND|OVER] [obj2...obj495]
  [IN n]

```

```
COMPUTE field [/format]=expression; [AS 'title1,...title5']
[AND] ROW-TOTAL [AND] COLUMN-TOTAL
```

```
BY [HIGHEST] keyfieldn [NOPRINT]
```

```
ON keyfield option1 [AND] option2...
```

```
WHERE [TOTAL] expression
```

```
IF [TOTAL] field relation value [OR value...]
```

```
ON TABLE SET parameter value
```

```
ON TABLE HOLD [VIA program] [AS name] [FORMAT format] [MISSING
{ON|OFF}]
ON TABLE PCHOLD [AS name] [FORMAT format] [MISSING
{ON|OFF}]
ON TABLE SAVE [AS name] [FORMAT format] [MISSING
{ON|OFF}]
ON TABLE SAVB [AS name] [FORMAT format] [MISSING
{ON|OFF}]
```

```
ON TABLE NOTOTAL
ON TABLE COLUMN-TOTAL fieldname
ON TABLE ROW-TOTAL fieldname
```

```
FOOTING [CENTER] [BOTTOM]
"text"
```

```
{END|RUN|QUIT}
```

i Note:

- Prefix operators for TABLEF can be: AVE., ASQ., MAX., MIN., FST., LST., CNT., or SUM.
- TABLEF requests cannot use:
 - Prefix operators DST., PCT., PCT.CNT., RPCT., and TOT.
 - Variables TABPAGENO, TABLASTPAGE, and BYLASTPAGE.
 - SET SQUEEZE
 - Border styling.
 - ACROSS phrases.
 - WITHIN phrases.
 - RANKED BY phrases.
 - NOSPLIT.
 - Requests with multiple display commands (multi-verb requests).

MATCH Syntax Summary

The syntax of a MATCH request is:

```

MATCH FILE filename      (the OLD file) report request
BY field1 [AS sortfield]
MORE
FILE file3
subrequest
RUN
.
.
.
FILE filename2          (the NEW file) report request
BY field1 [AS sortfield1]
.
.
.
[AFTER MATCH HOLD [AS filename] matchtype]
MORE
FILE file4

```

```
subrequest  
END
```

where:

matchtype

Can be any of the following:

```
OLD
```

```
NEW
```

```
OLD-NOT-NEW
```

```
NEW-NOT-OLD
```

```
OLD-AND-NEW
```

```
OLD-OR-NEW
```

```
OLD-NOR-NEW
```

FOR Syntax Summary

The formal syntax of the FOR statement is:

```
FOR fieldname [NOPRINT]row [OVER row]  
.  
.  
.  
.  
END
```

where:

row

Can be any of the following:

```
tag [OR tag...][options]
[fieldname]
DATA n,[n,...] $
DATA PICKUP [FROM filename] tag [LABEL label] [AS 'text']
RECAP name[/format]=expression;
BAR [AS 'character'] [OVER]
"text"
parentvalue {GET|WITH} CHILD[REN] [{n|ALL}] [ADD [m|ALL]]
  [AS {CAPTION|'text'}] [LABEL label]parentvalue ADD [{m|ALL}] [AS
{CAPTION|'text'}] [LABEL label]
PAGE-BREAK [OVER]
```

tag

Can be any of the following:

```
value [OR value...] value TO value
```

options

Can be any of the following:

```
AS 'text'
[INDENT m]
NOPRINT
[LABEL label]
WHEN EXISTS
[POST [TO filename]]
```

TABLE Limits

The following limits apply to TABLE requests:

- There is no limit to the number of verb objects in a TABLE request. However, an error can occur if the report output format has a limit to the number of columns supported, the operating system has a maximum record length that cannot fit all of the columns, or the amount of memory needed to store the output is not available.

- Number of verb objects referenced in a MATCH request: 495
- Number of columns of report output: 1024
- Total length of all fields in the request or in a single Master File: 256K
- Total number of sort fields (combined BY and ACROSS): 128

An internal sort will be generated automatically under some circumstances, and these have to be counted in the total. HOLD FORMAT FOCUS/XFOCUS will add FOCLIST as a BY field in order to ensure uniqueness.

- Maximum size of the output record: 256K (FORMAT/USAGE)
- Maximum size of the output file: FOCUS partition 2GB, XFOCUS 32GB
- Maximum size of internal expression representation of a single DEFINE, COMPUTE, -SET, or WHERE phrase: 64K

The internal representation is generated in polish postfix notation, which is significantly smaller than the entered expression. In addition, the constants in expressions (as in DECODE or IF...THEN..ELSE conditions) are stored outside of the expression representations, reducing the space requirement for the expression representation itself.

- Maximum number of segments in a structure or file: 512.

This means that a total of 511 JOINS can be in effect at any one given time.

i Note: FOCUS data sources are limited to 64 segments.

The maximum number of field pairs in a join is 128.

- Maximum size of Alphanumeric fields: 4K characters (in UTF, this means 12K bytes)
- Maximum number of display commands in a TABLE request: 64.

Writing User-Coded Programs to Create HOLD Files

HOLD files can be created by a user-coded program. This enables you to use the FOCUS Report Writer to obtain records from any FOCUS-readable data source, and write the records to another data source for use by an external program. This feature is most useful when an external program requires an internal format or arrangement of data other than those already provided with the HOLD command formats (for example, FORMAT FOCUS, LOTUS, SQL).

FOCUS collects records from the report request and passes them to the user program one at a time.

Arguments Used in Calls to Programs That Create HOLD Files

Call the program with the following arguments:

- RECNO is the record number in the HOLD file. The format is integer.
- LEN is the length of this record in the HOLD file. The format is integer.
- DDNAME is the name given in the HOLD AS phrase. The format is A8.
- RECORD is the record of data in the HOLD file. The format is Annnn (the maximum record length is 4096).
- RETCOD is the return code. The format is integer. A RETCOD of 0 signifies that the request has been processed normally. If RETCOD is non-zero, FOCUS terminates the report and display:

```
(FOC350) ERROR WRITING OUTPUT FILE:
```

The error message includes the non-zero value of RETCOD.

- ACVT is a one-word integer; reserved.

The subroutine must be allocated to the ddname FOCLIB. Compile and link the subroutine as a separate module with AMODE=31,RMODE=ANY.

Sample User-Coded Program That Creates a HOLD File

This simple COBOL program shows the use of these parameters. It executes when a report request includes the phrase ON TABLE HOLD VIA EXAMPLE, or when HOLD VIA EXAMPLE is issued from Hot Screen or after a report is displayed:

```
IDENTIFICATION DIVISION.  
PROGRAM-ID. EXAMPLE.  
INSTALLATION. IBI.  
  
ENVIRONMENT DIVISION.  
CONFIGURATION SECTION.  
SOURCE-COMPUTER. IBM-370.  
OBJECT-COMPUTER. IBM-370.  
  
INPUT-OUTPUT SECTION.  
FILE-CONTROL.  
  
DATA DIVISION.  
FILE SECTION.  
  
WORKING-STORAGE SECTION.  
LINKAGE SECTION.  
  
01  RECNO PIC S9(9) COMP.  
01  LEN PIC S9(9) COMP.  
01  DDNAME PIC X(8).  
01  REC PIC X(4096).  
01  RETCOD PIC S9(9) COMP.  
01  ACVT PIC S9(9) COMP.  
  
PROCEDURE DIVISION USING RECNO, LEN, DDNAME, REC, RETCOD, ACVT.  
  
    PERFORM SHOWPARMS.  
    GOBACK.  
  
SHOWPARMS.  
    DISPLAY " "  
    DISPLAY " EXAMPLE COBOL DISPLAY: "
```

```
DISPLAY " RECORD NUMBER " RECNO.  
DISPLAY " LENGTH OF RECORD IS " LEN.  
DISPLAY " DDNAME IS " DDNAME.  
DISPLAY " RECORD IS " REC.  
DISPLAY " RETURN CODE IS " RETCOD.  
DISPLAY " ACVT IS " ACVT.  
MOVE SPACES TO REC.
```

ibi Documentation and Support Services

For information about this product, you can read the documentation, contact Support, and join Community.

How to Access ibi Documentation

Documentation for ibi products is available on the [Product Documentation website](#), mainly in HTML and PDF formats.

The [Product Documentation website](#) is updated frequently and is more current than any other documentation included with the product.

Product-Specific Documentation

The documentation for this product is available on the [ibi™ FOCUS® Documentation](#) page.

How to Contact Support for ibi Products

You can contact the Support team in the following ways:

- To access the Support Knowledge Base and getting personalized content about products you are interested in, visit our [product Support website](#).
- To create a Support case, you must have a valid maintenance or support contract with a Cloud Software Group entity. You also need a username and password to log in to the [product Support website](#). If you do not have a username, you can request one by clicking **Register** on the website.

How to Join ibi Community

ibi Community is the official channel for ibi customers, partners, and employee subject matter experts to share and access their collective experience. ibi Community offers access to Q&A forums, product wikis, and best practices. It also offers access to extensions, adapters, solution accelerators, and tools that extend and enable customers to gain full value from ibi products. For a free registration, go to [ibi Community](#).

Legal and Third-Party Notices

SOME CLOUD SOFTWARE GROUP, INC. (“CLOUD SG”) SOFTWARE AND CLOUD SERVICES EMBED, BUNDLE, OR OTHERWISE INCLUDE OTHER SOFTWARE, INCLUDING OTHER CLOUD SG SOFTWARE (COLLECTIVELY, “INCLUDED SOFTWARE”). USE OF INCLUDED SOFTWARE IS SOLELY TO ENABLE THE FUNCTIONALITY (OR PROVIDE LIMITED ADD-ON FUNCTIONALITY) OF THE LICENSED CLOUD SG SOFTWARE AND/OR CLOUD SERVICES. THE INCLUDED SOFTWARE IS NOT LICENSED TO BE USED OR ACCESSED BY ANY OTHER CLOUD SG SOFTWARE AND/OR CLOUD SERVICES OR FOR ANY OTHER PURPOSE.

USE OF CLOUD SG SOFTWARE AND CLOUD SERVICES IS SUBJECT TO THE TERMS AND CONDITIONS OF AN AGREEMENT FOUND IN EITHER A SEPARATELY EXECUTED AGREEMENT, OR, IF THERE IS NO SUCH SEPARATE AGREEMENT, THE CLICKWRAP END USER AGREEMENT WHICH IS DISPLAYED WHEN ACCESSING, DOWNLOADING, OR INSTALLING THE SOFTWARE OR CLOUD SERVICES (AND WHICH IS DUPLICATED IN THE LICENSE FILE) OR IF THERE IS NO SUCH LICENSE AGREEMENT OR CLICKWRAP END USER AGREEMENT, THE LICENSE(S) LOCATED IN THE “LICENSE” FILE(S) OF THE SOFTWARE. USE OF THIS DOCUMENT IS SUBJECT TO THOSE SAME TERMS AND CONDITIONS, AND YOUR USE HEREOF SHALL CONSTITUTE ACCEPTANCE OF AND AN AGREEMENT TO BE BOUND BY THE SAME.

This document is subject to U.S. and international copyright laws and treaties. No part of this document may be reproduced in any form without the written authorization of Cloud Software Group, Inc.

ibi, the ibi logo, FOCUS, iWay, WebFOCUS, RStat, Information Builders, Studio, and TIBCO are either registered trademarks or trademarks of Cloud Software Group, Inc. in the United States and/or other countries.

All other product and company names and marks mentioned in this document are the property of their respective owners and are mentioned for identification purposes only. You acknowledge that all rights to these third party marks are the exclusive property of their respective owners. Please refer to Cloud SG’s Third Party Trademark Notices (<https://www.cloud.com/legal>) for more information.

This document includes fonts that are licensed under the SIL Open Font License, Version 1.1, which is available at: <https://scripts.sil.org/OFL>

Copyright (c) Paul D. Hunt, with Reserved Font Name Source Sans Pro and Source Code Pro.

Cloud SG software may be available on multiple operating systems. However, not all operating system platforms for a specific software version are released at the same time. See the “readme” file for the availability of a specific version of Cloud SG software on a specific operating system platform.

THIS DOCUMENT IS PROVIDED “AS IS” WITHOUT WARRANTY OF ANY KIND, EITHER EXPRESS OR IMPLIED, INCLUDING, BUT NOT LIMITED TO, THE IMPLIED WARRANTIES OF MERCHANTABILITY, FITNESS FOR A PARTICULAR PURPOSE, OR NON-INFRINGEMENT.

THIS DOCUMENT COULD INCLUDE TECHNICAL INACCURACIES OR TYPOGRAPHICAL ERRORS. CHANGES ARE PERIODICALLY ADDED TO THE INFORMATION HEREIN; THESE CHANGES WILL BE INCORPORATED IN NEW EDITIONS OF THIS DOCUMENT. CLOUD SG MAY MAKE IMPROVEMENTS AND/OR CHANGES IN THE PRODUCT(S), THE PROGRAM(S), AND/OR THE SERVICES DESCRIBED IN THIS DOCUMENT AT ANY TIME WITHOUT NOTICE.

THE CONTENTS OF THIS DOCUMENT MAY BE MODIFIED AND/OR QUALIFIED, DIRECTLY OR INDIRECTLY, BY OTHER DOCUMENTATION WHICH ACCOMPANIES THIS SOFTWARE, INCLUDING BUT NOT LIMITED TO ANY RELEASE NOTES AND "README" FILES.

This and other products of Cloud SG may be covered by registered patents. For details, please refer to the Virtual Patent Marking document located at <https://www.cloud.com/legal>.

Copyright © 2021-2025. Cloud Software Group, Inc. All Rights Reserved.