



ibi™ FOCUS®

Describing Data

Version 9.3.2 | November 2024



Contents

Contents	2
Understanding a Data Source Description	29
A Note About Data Source Terminology	29
What Is a Data Source Description?	30
How an Application Uses a Data Source Description	30
What Does a Master File Describe?	31
Identifying a Data Source	32
Identifying and Relating a Group of Fields	32
Describing a Field	33
Creating a Data Source Description	33
Creating a Master File and Access File Using an Editor	33
Creating a Master and Access File Using an Editor	34
Naming a Master File	34
Using Long Master File Names	34
Member Names for Long Master File Names	35
Long Master File Names and Corresponding Member Names	35
Implement a Long Master File Name	37
Allocate a Long Master File Name	37
Free an Allocation for a Long Master File Name	38
Using a Long Master File Name	38
Usage Notes for Long Master File Names	39
What Is in a Master File?	40
Specify a Declaration	40
Improving Readability	41
Improving Readability With Blank Spaces and Blank Lines	41
Improving Readability by Extending a Declaration Across Lines	42

Adding a Comment	42
Adding a Comment in a Master File	42
Editing and Validating a Master File	43
Identifying a Data Source	44
Identifying a Data Source Overview	44
Specifying a Data Source Name: FILENAME	45
Specify a Data Source Name	45
Specifying a Data Source Name	45
Identifying a Data Source Type: SUFFIX	46
Identify a Data Source Type	46
Specifying the Type for a FOCUS Data Source	46
SUFFIX Values	47
Specifying a Code Page in a Master File	51
Specify a Code Page for a Master File	51
Specifying Byte Order	52
Specify Byte Order	52
Specifying Data Type: IOTYPE	52
Providing Descriptive Information for a Data Source: REMARKS	53
Document a Data Source	53
Providing Descriptive Information for an Oracle Table	54
Specifying a Physical File Name: DATASET	54
DATASET Behavior in a FOCUS Data Source	55
Use the DATASET Attribute at the File Level	56
Allocating a FOCUS Data Source Using the DATASET Attribute	56
Allocating a Data Source for the FOCUS Database Server	58
DATASET Behavior in a Fixed-Format Sequential Data Source	59
Use the DATASET Attribute With a Fixed-Format Data Source	59
Allocating a Fixed-Format Data Source Using the DATASET Attribute	60
DATASET Behavior in a VSAM Data Source	61
Use the DATASET Attribute With a VSAM, ISAM, or C-ISAM Data Source	62

Allocating a VSAM Data Source Using the DATASET Attribute	62
Allocating a C-ISAM Data Source Using the DATASET Attribute	63
Storing Localized Metadata in Language Files	63
LNGPREP Utility: Preparing Metadata Language Files	63
The Base Language File	64
How Translated Master File Attributes Display	65
LNGPREP Prerequisites	65
LNGPREP Best Practice	66
Prepare Metadata Language Files Using the Web Console	66
Run the LNGPREP Command Using Syntax	67
Sample LNGPREP Command	68
Creating and Using a Master File Profile	69
Invoke a Master File Profile	69
Usage Notes for MFD_PROFILE	70
Describing a Group of Fields	83
Defining a Single Group of Fields	83
Understanding a Segment	83
Understanding a Segment Instance	84
Understanding a Segment Chain	85
Identifying a Key Field	85
Identifying a Segment: SEGNAME	86
Identify a Segment	86
Identifying a Segment	87
Identifying a Logical View: Redefining a Segment	87
Omitting a Field: Creating a Segment Subset	88
Redefining a Field: Creating a Filler Field	88
Relating Multiple Groups of Fields	89
Facilities for Specifying a Segment Relationship	90
Identifying a Parent Segment: PARENT	90
Identify the Parent Segment	91

Identifying a Parent Segment	91
Identifying the Type of Relationship: SEGTYPE	91
Understanding the Efficiency of the Minimum Referenced Subtree	92
Logical Dependence: The Parent-Child Relationship	93
A Simple Parent-Child Relationship	93
A Parent-Child Relationship With Multiple Segments	94
Understanding a Root Segment	95
Understanding a Descendant Segment	95
Understanding an Ancestral Segment	96
Logical Independence: Multiple Paths	96
Understanding a Single Path	97
Understanding Multiple Paths	97
Understanding Logical Independence	98
Cardinal Relationships Between Segments	99
One-to-One Relationship	100
Understanding a One-to-One Relationship	100
Where to Use a One-to-One Relationship	101
Implementing a One-to-One Relationship in a Relational Data Source	102
Implementing a One-to-One Relationship in a Sequential Data Source	102
Implementing a One-to-One Relationship in a FOCUS Data Source	102
One-to-Many Relationship	103
Understanding a One-to-Many Relationship	103
Implementing a One-to-Many Relationship in a Relational Data Source	104
Implementing a One-to-Many Relationship in a VSAM or Sequential Data Source	104
Implementing a One-to-Many Relationship in a FOCUS Data Source	105
Many-to-Many Relationship	105
Implementing a Many-to-Many Relationship Directly	106
Implementing a Many-to-Many Relationship Directly	107
Implementing a Many-to-Many Relationship Indirectly	107
Recursive Relationships	110
A Recursive Join With a Single Segment	110

A Recursive Join With Multiple Segments	111
Relating Segments From Different Types of Data Sources	113
Rotating a Data Source: An Alternate View	113
Specify an Alternate View	115
Specifying an Alternative View	116
Other Uses of an Alternate View	116
Defining a Prefix for Field Titles	118
Define a Prefix for Field Titles	118
Defining a Prefix for Field Titles	119
Generating a HOLD File When a Segment Specifies a SEG_TITLE_PREFIX	121
Describing an Individual Field	122
Field Characteristics	122
The Field Name: FIELDNAME	123
Identify the Field Name	123
Usage Notes for FIELDNAME	124
Restrictions for Field Names	124
Using a Qualified Field Name	125
Specify a Qualified Field Name in a Request	125
Qualifying a Field Name	126
Change the Qualifying Character	126
Using a Duplicate Field Name	126
Rules for Evaluating a Qualified Field Name	127
The Field Synonym: ALIAS	130
Using a Field Synonym	131
Implementing a Field Synonym	131
The Displayed Data Type: USAGE	132
Specifying a Display Format	132
Specify a Display Format	133
Usage Notes for USAGE	133
Data Type Formats	134

Integer Format	135
Floating-Point Double-Precision Format	136
Floating-Point Single-Precision Format	137
Extended Decimal Precision Floating-Point Format (XMATH)	138
Decimal Precision Floating-Point Format (MATH)	139
Packed-Decimal Format	140
Numeric Display Options	141
Using Numeric Display Options	146
Using International System (SI) Numeric Format Abbreviation Options	148
Extended Currency Symbol Display Options	150
Extended Currency Symbol Formats	152
Displaying Extended Currency Symbols	152
Select an Extended Currency Symbol	153
Displaying Extended Currency Symbols	154
Locale Display Options for Currency Values	155
Specifying Currency Parameters in a DEFINE	157
Rounding	158
Alphanumeric Format	159
Usage Notes for 4K Alphanumeric Fields	160
Hexadecimal Format	161
String Format	163
Date Formats	163
Date Display Options	163
How Field Formats Y, YY, M, and W Are Stored	166
Date Literals Interpretation Table	166
Controlling the Date Separator	171
Date Translation	172
Using a Date Format	173
Using a Date Field	174
Numeric Date Literals	175
Date Fields in Arithmetic Expressions	176

Converting a Date Field	176
Convert a Date Field	177
How a Date Field Is Represented Internally	177
Using Full Date Formats and Component Date Formats	179
Displaying a Non-Standard Date Format	179
Invoke ALLOWCVTERR	180
Date Format Support	181
Alphanumeric and Numeric Formats With Date Display Options	181
Date-Time Formats	183
Enable ISO Standard Date-Time Notation	183
Using SET DTSTANDARD	184
Describing a Date-Time Field	185
Describe a Numeric Date-Time Value Without Display Options	185
Describe a Time-Only Value	186
Display Options for a Time-Only Value	187
Describe a Date-Time Value	189
Display Options for the Date Component of a Date-Time Field	190
Using Zero Removal for Date-Time Month and Day Numbers	192
Comparing Zero Suppression With Zero Removal	193
Display Options for the Time Component of a Date-Time Field	194
Date-Time Usage Notes	196
Character Format AnV	196
Specify AnV Fields in a Master File	196
Specifying the AnV Format in a Master File	197
Usage Notes for AnV Format	198
Propagating an AnV Field to a HOLD File	199
Propagating an AnV Field to a HOLD File	199
Text Field Format	199
Specify a Text Field in a Master File	200
Usage Notes for Text Field Format	201
The Stored Data Type: ACTUAL	201

ACTUAL Attribute	201
Specify the ACTUAL Attribute	202
ACTUAL to USAGE Conversion	204
COBOL Picture to USAGE Format Conversion	205
Adding a Geographic Role for a Field	207
GEOGRAPHIC_ROLE Attribute	207
Specify a Geographic Role	207
Null or MISSING Values: MISSING	209
Specify a Missing Value	210
Usage Notes for MISSING	210
Using a Missing Value	211
Describing an FML Hierarchy	211
Specify a Hierarchy Between Fields in a Master File	212
Assign Descriptive Captions for Hierarchy Field Values	213
Defining a Hierarchy in a Master File	214
Validating Data: ACCEPT	214
Validate Data	215
Specifying a List With an Embedded Blank	217
Usage Notes for ACCEPT	217
.....	218
Specify an Alternative Title	218
Replacing the Default Column Title	219
Usage Notes for TITLE	219
Documenting the Field: DESCRIPTION	219
Supply Field Documentation	220
Specifying a DESCRIPTION	220
Usage Notes for DESCRIPTION	220
Multilingual Metadata	221
Activate the Use of a Language	221
Activating a Language in the NLS Configuration File	222
Languages and Language Code Abbreviations	222

Placing Multilingual Metadata Directly in a Master File	224
Specify Multilingual Metadata in a Master File	224
Usage Notes for Multilingual Metadata	226
Using Multilingual Descriptions in a Master File	226
Using Multilingual Titles in a Request	227
Describing a Virtual Field: DEFINE	228
Define a Virtual Field	229
Defining a Field	231
Usage Notes for Virtual Fields in a Master File	232
Using a Virtual Field	232
Describing a Calculated Value: COMPUTE	233
Include a COMPUTE Command in a Master File	233
Usage Notes for COMPUTE in a Master File	236
Coding a COMPUTE in the Master File and Accessing the Computed Value	236
Describing a Filter: FILTER	237
Declare a Filter in a Master File	238
Use a Master File Filter in a Request	239
Usage Notes for Filters in a Master File	239
Defining and Using a Master File Filter	239
Using a Mandatory Filter	241
Describing a Sort Object: SORTOBJ	242
Usage Notes for Sort Objects in a Master File	243
Declare a Sort Object in a Master File	243
Reference a Sort Object in a Request	244
Declaring and Referencing a Sort Object	244
Calling a DEFINE FUNCTION in a Master File	245
Call a DEFINE FUNCTION in a Master File Expression	245
Using a DEFINE FUNCTION in a Master File	246
Using Date System Amper Variables in Master File DEFINES	247
Using the Date Variable &DATE in a Master File DEFINE	248
Using the Date Variable &YYMD in a Master File DEFINE	249

Messages for Date System Amper Variables in Master File DEFINES	250
Parameterizing Master and Access File Values Using Variables	251
Create a Master File Variable	251
Support for Variables in Master and Access File Attributes	252
Parameterizing Attributes in a Master and Access File	252
Concatenating Variables to Create an Attribute Value	254
Converting Alphanumeric Dates to FOCUS Dates	255
Usage Notes for DATEPATTERN	256
Specifying Variables in a Date Pattern	256
Specify Years in a Date Pattern	256
Specify Month Numbers in a Date Pattern	257
Specify Month Names in a Date Pattern	257
Specify Days of the Month in a Date Pattern	258
Specify Julian Days in a Date Pattern	258
Specify Day of the Week in a Date Pattern	258
Specify Quarters in a Date Pattern	259
Specifying Constants in a Date Pattern	259
Sample Date Patterns	260
Sorting By an Alphanumeric Date	260
Describing a Sequential, VSAM, or ISAM Data Source	264
Sequential Data Source Formats	264
What Is a Fixed-Format Data Source?	265
What Is a Comma or Tab-Delimited Data Source?	267
Accessing SUFFIX=COM Data Sources	268
Accessing SUFFIX=COMT Data Sources	269
Accessing SUFFIX=TAB Data Sources	269
Accessing SUFFIX=TABT Data Sources	269
What Is a Free-Format Data Source?	270
Rules for Maintaining a Free-Format Data Source	271
Standard Master File Attributes for a Sequential Data Source	271

Standard Master File Attributes for a VSAM or ISAM Data Source	272
Describing a Group Field With Formats	273
Describe a VSAM Group Field With Formats	274
Describing a VSAM Group Field With Formats	274
Describing a VSAM Group Field With Multiple Formats	275
Accessing a Group Field With Multiple Formats	275
Describing a Group Field as a Set of Elements	276
Describe a GROUP Field as a Set of Elements	276
Usage Notes for Group Elements	277
Declaring a GROUP With ELEMENTS	278
Describing a Multiply Occurring Field in a Free-Format Data Source	279
Describing a Multiply Occurring Field in a Free-Format Data Source	279
Describing a Multiply Occurring Field in a Fixed-Format, VSAM, or ISAM Data Source	280
Using the OCCURS Attribute	281
Specify a Repeating Field	282
Using the OCCURS Attribute	282
Describing a Parallel Set of Repeating Fields	283
Describing a Nested Set of Repeating Fields	284
Describing Parallel and Nested Repeating Fields	285
Using the POSITION Attribute	287
Specify the Position of a Repeating Field	288
Specifying the Position of a Repeating Field	288
Specifying the ORDER Field	289
Specify the Sequence of a Repeating Field	289
Using the ORDER Attribute in a Selection Test	290
Redefining a Field in a Non-FOCUS Data Source	290
Redefine a Field	291
Redefining a VSAM Structure	291
Special Considerations for Redefining a Field	292
Extra-Large Record Length Support	292

Define the Maximum Record Length	292
Describing Multiple Record Types	293
SEGTYPE Attributes With RECTYPE Fields	294
Describing a RECTYPE Field	294
Specify a Record Type Field	295
Specifying the RECTYPE Field	296
Describing Positionally Related Records	297
Ordering of Records in the Data Source	298
Describing VSAM Positionally Related Records	299
Describing Unrelated Records	300
Describing Unrelated Records Using a Dummy Root Segment	301
Describing a VSAM Data Source With Unrelated Records	302
Describing a Key and a Record Type for a VSAM Data Source With Unrelated Records	304
Using a Generalized Record Type	305
Specify a Generalized Record Type	305
Using a Generalized Record Type	306
Using an ALIAS in a Report Request	308
Using a RECTYPE Value in a Display Command	308
Using a RECTYPE Value in a WHERE Test	308
Combining Multiply Occurring Fields and Multiple Record Types	309
Describing a Multiply Occurring Field and Multiple Record Types	309
Describing a VSAM Repeating Group With RECTYPES	312
Describing a VSAM Repeating Group With RECTYPES	313
Describing a Repeating Group Using MAPFIELD	314
Describe a Repeating Group With MAPFIELD	315
Use MAPFIELD for a Descendant Repeating Segment in a Repeating Group	316
Using MAPFIELD and MAPVALUE	317
Establishing VSAM Data and Index Buffers	318
Establish VSAM Data and Index Buffers	318
Determining How Many Buffers Are in Effect	318

Using a VSAM Alternate Index	319
Describing a VSAM Alternate Index	320
Using IDCAMS	320
Describing a Token-Delimited Data Source	321
Defining a Delimiter in the Master File	322
Define a File With Delimiters in the Master File	322
Usage Notes for a Token-Delimited File	323
Defining a Delimiter in the Master File	324
Separating Field Values for Missing Data	325
Defining a Delimiter in the Access File	326
Access File Attributes for a Delimited Sequential File	326
Master and Access File for a Pipe Delimited File	328
Creating a Delimited File With Blank Spaces Preserved	330
Specifying a Record Delimiter	332
Describing a FOCUS Data Source	335
Types of FOCUS Data Sources	335
Using a SUFFIX=FOC Data Source	336
Using an XFOCUS Data Source	336
Specify an XFOCUS Data Source	336
Control the Number of Pages Used for XFOCUS Data Source Buffers	337
Create an XFOCUS Data Source	337
Usage Notes for the XFOCUS Data Source	338
Designing a FOCUS Data Source	338
Data Relationships	339
Join Considerations	340
General Efficiency Considerations	340
Changing a FOCUS Data Source	341
Describing a Single Segment	341
Describing Keys, Sort Order, and Segment Relationships: SEGTYPE	342
Describe a Segment	342

Usage Notes for SEGTYPE	344
Describing a Key Field	345
Describing Sort Order	345
Understanding Sort Order	345
Describing Segment Relationships	346
Storing a Segment in a Different Location: LOCATION	347
Store a Segment in a Different Location	348
Specifying Location for a Segment	348
Separating Large Text Fields	349
Limits on the Number of Segments, LOCATION Files, Indexes, and Text Fields	350
FDT Entries for a FOCUS or XFOCUS Data Source	350
Specifying a Physical File Name for a Segment: DATASET	351
Use the DATASET Attribute on the Segment Level	353
Allocating a Segment Using the DATASET Attribute	354
Timestamping a FOCUS Segment: AUTODATE	354
Define an AUTODATE Field for a Segment	355
Defining an AUTODATE Field	355
Usage Notes for AUTODATE	357
GROUP Attribute	357
Describing a Group Field With Formats	358
Define a Group Field With Formats	358
Usage Notes for Group Fields in FOCUS Data Sources	359
Displaying an Alphanumeric Group Field	361
Screening on a Group Field With an Integer Component	361
Describing a Group Field as a Set of Elements	362
Describe a GROUP Field as a Set of Elements	363
Usage Notes for Group Elements	364
Declaring a GROUP With ELEMENTS	364
ACCEPT Attribute	365
Specify Data Validation	365
INDEX Attribute	366

Specify Field Indexing	367
Specifying an Index for the JOBCODE Field	367
Joins and the INDEX Attribute	367
Usage Notes for INDEX	368
FORMAT and MISSING: Internal Storage Requirements	369
Describing a Partitioned FOCUS Data Source	370
Intelligent Partitioning	370
Specifying an Access File in a FOCUS Master File	371
Specify an Access File for a FOCUS Data Source	371
Master File for the VIDEOTR2 Partitioned Data Source	371
Using a Partitioned Data Source	372
Usage Notes for Partitioned FOCUS Data Sources	373
FOCUS Access File Attributes	374
Access File Attributes for a FOCUS Access File	374
Create a FOCUS Access File	375
Access File for the VIDEOTR2 Data Source	377
Multi-Dimensional Index (MDI)	378
Specifying an MDI in the Access File	379
Specify an MDI in an Access File	379
Defining an MDI	380
Creating a Multi-Dimensional Index	381
Choosing Dimensions for Your Index	381
Guidelines for a Multi-Dimensional Index	382
Building and Maintaining a Multi-Dimensional Index	383
Creating a Multi-Dimensional Index in a FOCUS Session	383
Creating a Multi-Dimensional Index in a FOCEXEC	385
Using a Multi-Dimensional Index in a Query	385
Querying a Multi-Dimensional Index	386
Query a Multi-Dimensional Index	386
Using AUTOINDEX to Choose an MDI	387
Enable or Disable AUTOINDEX for Retrieval	387

Joining to a Multi-Dimensional Index	388
Join to All Dimensions of a Multi-Dimensional Index	389
Create a Dimensional Join	390
Guidelines for Choosing a Source Field (Dimensional Joins Only)	391
Encoding Values in a Multi-Dimensional Index	391
Rules for Encoding a Multi-Dimensional Index	391
Retrieve Output From a Multi-Dimensional Index	392
Encode a Multi-Dimensional Index	392
Encoding a Multi-Dimensional Index	393
Using a Multi-Dimensional Index in a Request	393
Partitioning a Multi-Dimensional Index	394
Adding a Partition to a Multi-Dimensional Index at the Command Prompt	394
Adding a Partition to a Multi-Dimensional Index in a FOCEXEC	396
Querying the Progress of a Multi-Dimensional Index	396
Query the Progress of a Multi-Dimensional Index	396
Displaying a Warning Message	397
Display a Warning Message	397
Defining a Join in a Master File	398
Join Types	398
Static Joins Defined in the Master File: SEGTYPE = KU and KM	399
Describing a Unique Join: SEGTYPE = KU	399
Specify a Static Unique Join	401
Creating a Static Unique Join	402
Using a Unique Join for Decoding	402
Describing a Non-Unique Join: SEGTYPE = KM	403
Specify a Static Multiple Join	403
Specifying a Static Multiple Join	404
Using Cross-Referenced Descendant Segments: SEGTYPE = KL and KLU	405
Identify Cross-Referenced Descendant Segments	406
Identifying a Cross-Referenced Descendant Segment	407

Using a Cross-Referenced Descendant Segment	407
Using a Cross-Referenced Ancestral Segment	408
Hierarchy of Linked Segments	410
Dynamic Joins Defined in the Master File: SEGTYPE = DKU and DKM	411
Specify a Dynamic Join in a Master File	411
Specifying a Dynamic Join in a Master File	412
Conditional Joins in the Master File	412
How to Define a Conditional Join in the Master File	413
Using a Conditional Join in the Master File	414
Comparing Static and Dynamic Joins	415
Joining to One Cross-Referenced Segment From Several Host Segments	417
Joining From Several Segments in One Host Data Source	418
Joining From Several Segments in Several Host Data Sources: Multiple Parents	420
Recursive Reuse of a Segment	422
Creating a Single-Root Cluster Master File	422
Reading a Field Containing Delimited Values as individual Rows	423
Read a Field Containing Delimited Values as Individual Rows	423
Reading a Field Containing Delimited Values as Individual Rows	424
Creating a Multiple-Root Cluster Master File	427
Define a Multi-Fact Cluster	428
Creating a Business View of a Master File	431
Grouping Business Logic In a Business View	431
Define a Folder	432
Languages and Language Codes	433
Usage Notes for Business Views	435
Creating a Business View	436
Business View DV Roles	440
Assigning DV Roles	441
Sample Dimension Folder Declaration	442
Checking and Changing a Master File: CHECK	443

Checking a Data Source Description	443
Check a Data Source Description	443
CHECK Command Display	444
CHECK FILE Command Output	444
Using the CHECK File Command	446
Determining Common Errors	446
PICTURE Option	447
Using the CHECK FILE PICTURE Option	449
HOLD Option	449
Using the CHECK FILE HOLD Option	451
Using the CHECK FILE HOLD ALL Option	452
Specifying an Alternate File Name With the HOLD Option	452
TITLE, HELPMESSAGE, and TAG Attributes	452
Virtual Fields in the Master File	453
Accessing a FOCUS Data Source: USE	454
USE Command	454
Issue a USE Command	455
Specify Multiple Data Sources	457
Erase USE Specifications	457
Specifying a Non-Default File ID	457
Specify a Non-Default File ID	458
Specifying Different File Names	458
Identifying New Data Sources to FOCUS	458
Identify New Data Sources to FOCUS	459
Identifying a New Data Source	459
Accessing Data Sources in Read-Only Mode	459
Access a Data Source in Read-Only Mode	460
Accessing a Data Source in Read-Only Mode	460
Concatenating Data Sources	460
Concatenate Data Sources	460

Concatenating Data Sources to One Master File	461
Concatenating Multiple Master Files	461
Concatenating Multiple Data Sources and a Single Cross-Reference Data Source	462
Concatenating Multiple Data Sources and Multiple Cross-Reference Data Sources	462
Accessing Simultaneous Usage Data Sources	463
Access Simultaneous Usage Data Sources	463
Accessing an SU Data Source	463
Multi-Thread Configuration	464
Read SU Data Sources in a Multi-Thread Configuration	464
Displaying the USE Options in Effect	465
Displaying USE Options	465
Providing Data Source Security: DBA	466
Introduction to Data Source Security	466
Implementing Data Source Security	467
Implementing Data Source Security in a Master File	468
Special Considerations for Data Source Security	469
Identifying the DBA: The DBA Attribute	469
Identifying the DBA Using the DBA Attribute	470
Change a DBA Password	470
Including the DBA Attribute in a HOLD File	471
Including a Comment in a HOLD Master File	472
Including DBA Attributes in a HOLD Master File	473
Identifying Users With Access Rights: The USER Attribute	474
Set the USER Attribute	474
Setting the USER Attribute	475
Non-Overridable User Passwords (SET PERMPASS)	475
Set a Non-Overridable User Password	475
Setting a Non-Overridable User Password	476
Usage Notes for Non-Overridable User Passwords	477
Controlling Case Sensitivity of Passwords	477

Control Password Case Sensitivity	478
Controlling Password Case Sensitivity	478
Establishing User Identity	479
Establish User Identity	479
Establishing User Identity	480
Specifying an Access Type: The ACCESS Attribute	481
Types of Access	482
CHECK Command	483
RESTRICT Attribute Keywords	483
CREATE Command	485
DECRYPT Command	485
DEFINE Command	485
ENCRYPT Command	485
Host Language Interface (HLI)	485
MODIFY or MAINTAIN Command	486
REBUILD Command	486
RESTRICT Command	486
FSCAN Facility	486
SCAN Facility	487
TABLE or MATCH Command	487
Limiting Data Source Access: The RESTRICT Attribute	487
Limit Data Source Access	487
Restricting Access to Values Using VALUE_WHERE	489
Limiting Data Source Access	490
Restricting Access to a Field or a Segment	491
Restrict Access to a Field or a Segment	491
Restricting Access to a Segment	492
Reusing a Common Set of Access Restrictions	492
Restricting Access to a Value	493
Restrict Values a User Can Read	494
Restricting Values a User Can Read	494

Restricting Both Read and Write Values	496
Restricting Values a User Can Write	496
Restrict Values a User Can Write	496
Restrict Values a User Can Enter in a Segment	497
Restricting Values a User Can Write	497
Restricting Values a User Can Alter	498
Restrict Values a User Can Alter	498
Restricting Values a User Can Alter	499
Restricting Both Read and Write Values	499
Restricting Both Read and Write Values for a User	499
Controlling the Source of Access Restrictions in a Multi-file Structure	500
Control Enforcement of Access Restrictions in a JOIN or COMBINE Structure	501
Usage Notes for SET DBASOURCE	501
Controlling Access Restrictions in a JOIN	502
Adding DBA Restrictions to the Join Condition	504
Placing Security Information in a Central Master File	505
Place Security Attributes in a Central Master File	507
Placing Security Attributes in a Central Master File	507
Using DBAFILE With a Join Structure	508
File Naming Requirements for DBAFILE	510
DBAFILE Naming Conventions	511
Connection to an Existing DBA System With DBAFILE	511
Connecting to an Existing DBA System With DBAFILE	512
Combining Applications With DBAFILE	512
Summary of Security Attributes	512
Hiding Restriction Rules: The ENCRYPT Command	514
Hide Restriction Rules: ENCRYPT Command	514
Encrypting and Decrypting a Master File	515
Encrypting Data	515
Encrypting Data	515
Performance Considerations for Encrypted Data	516

Displaying the Decision Table	517
Display the Decision Table	517
Displaying the Decision Table	517
Setting a Password Externally	518
FOCEXEC Security	519
Suppressing Password Display	519
Suppress Password Display	519
Suppressing Password Display	519
Setting a Password in an Encrypted FOCEXEC	520
Defining Variable Passwords	520
Encrypting and Decrypting a FOCEXEC	521
Encrypt and Decrypt a FOCEXEC	521
Encrypt and Decrypt a FOCEXEC	521
Locking a FOCEXEC User Out of FOCUS	522
Master Files and Diagrams	523
Creating Sample Data Sources	523
EMPLOYEE Data Source	525
EMPLOYEE Master File	527
EMPLOYEE Structure Diagram	528
JOBFILE Data Source	528
JOBFILE Master File	529
JOBFILE Structure Diagram	529
EDUCFILE Data Source	530
EDUCFILE Master File	530
EDUCFILE Structure Diagram	530
SALES Data Source	531
SALES Master File	532
SALES Structure Diagram	532
PROD Data Source	533
PROD Master File	533

PROD Structure Diagram	534
CAR Data Source	534
CAR Master File	535
CAR Structure Diagram	536
LEDGER Data Source	536
LEDGER Master File	537
LEDGER Structure Diagram	537
FINANCE Data Source	537
FINANCE Master File	537
FINANCE Structure Diagram	538
REGION Data Source	538
REGION Master File	538
REGION Structure Diagram	539
COURSES Data Source	539
COURSES Master File	539
COURSES Structure Diagram	539
EMPDATA Data Source	540
EMPDATA Master File	540
EMPDATA Structure Diagram	541
EXPERSON Data Source	541
EXPERSON Master File	541
EXPERSON Structure Diagram	542
TRAINING Data Source	542
TRAINING Master File	542
TRAINING Structure Diagram	543
COURSE Data Source	543
COURSE Master File	543
COURSE Structure Diagram	544
JOBHIST Data Source	544
JOBHIST Master File	544
JOBHIST Structure Diagram	545

JOBLIST Data Source	545
JOBLIST Master File	545
JOBLIST Structure Diagram	546
LOCATOR Data Source	546
LOCATOR Master File	546
LOCATOR Structure Diagram	547
PERSINFO Data Source	547
PERSINFO Master File	547
PERSINFO Structure Diagram	548
SALHIST Data Source	548
SALHIST Master File	548
SALHIST Structure Diagram	548
PAYHIST File	549
PAYHIST Master File	549
PAYHIST Structure Diagram	549
COMASTER File	550
COMASTER Master File	550
COMASTER Structure Diagram	551
VIDEOTRK, MOVIES, and ITEMS Data Sources	552
VIDEOTRK Master File	552
VIDEOTRK Structure Diagram	553
MOVIES Master File	554
MOVIES Structure Diagram	554
ITEMS Master File	555
ITEMS Structure Diagram	555
VIDEOTR2 Data Source	556
VIDEOTR2 Master File	556
VIDEOTR2 Structure Diagram	556
Gotham Grinds Data Sources	557
GGDEMOG Master File	558
GGDEMOG Structure Diagram	559

GGORDER Master File	559
GGORDER Structure Diagram	559
GGPRODS Master File	560
GGPRODS Structure Diagram	561
GGSALES Master File	561
GGSALES Structure Diagram	562
GGSTORES Master File	562
GGSTORES Structure Diagram	563
Century Corp Data Sources	563
CENTCOMP Master File	564
CENTCOMP Structure Diagram	565
CENTFIN Master File	565
CENTFIN Structure Diagram	566
CENTHR Master File	566
CENTHR Structure Diagram	569
CENTINV Master File	569
CENTINV Structure Diagram	570
CENTORD Master File	570
CENTORD Structure Diagram	571
CENTQA Master File	572
CENTQA Structure Diagram	573
CENTGL Master File	574
CENTGL Structure Diagram	575
CENTSYSF Master File	575
CENTSYSF Structure Diagram	575
CENTSTMT Master File	576
CENTSTMT Structure Diagram	576
CENTGLL Master File	577
CENTGLL Structure Diagram	578
Error Messages	579

Accessing Error Files	579
Displaying Messages	579
User Exits for a Non-FOCUS Data Source	581
Dynamic and Re-Entrant Private User Exit of the FOCSAM Interface	581
Functional Requirements	582
Implementation	583
Master File	583
Access File	583
Calling Sequence	584
Work Area Control Block	585
Sample Assembler DSECT	587
Sample C Declaration Required For Invoking FFUN Function	588
User-coded Data Access Modules	589
Re-Entrant VSAM Compression Exit: ZCOMP1	591
Linking ZCOMP1	592
What Happens When You Use ZCOMP1	592
ZCOMP1 Parameter List	593
Rounding in FOCUS	595
Data Storage and Display	595
Integer Fields: Format I	596
Floating-Point Fields: Formats F and D	597
Packed Decimal Format: Format P	597
Storing and Displaying Values	598
Rounding in Calculations and Conversions	600
Redefining Field Formats	601
DEFINE and COMPUTE	604
File Description Attribute Summary	606
Overview of File Descriptions	606
Master File Attributes	606

Master File FILE Attributes	607
Master File Segment Attributes	607
Master File Field Attributes	608
Master File Attributes That Join Data Sources	610
Master File Data Security Attributes	611
Master File Hierarchy Attributes	612
Access File Attributes	612
General Access File Attributes	612
MDI Access File Attributes	613
Related Commands	613
ibi Documentation and Support Services	615
Legal and Third-Party Notices	616

Understanding a Data Source Description

FOCUS® products provide a flexible data description language, which you can use with many types of data sources, including:

- Relational, such as DB2, Oracle, Sybase, and Teradata.
- Hierarchical, such as IMS, FOCUS, and XFOCUS.
- Network, such as CA-IDMS.
- Indexed, such as ISAM and VSAM.
- Sequential, both fixed-format and free-format.
- Multidimensional, such as Essbase.

You can also use the data description language and related facilities to:

- Join different types of data sources to create a temporary structure from which your request can read or write.
- Define a subset of fields or columns to be available to users.
- Logically rearrange a data source to access the data in a different order.

A Note About Data Source Terminology

Different types of data sources make use of similar concepts but refer to each differently. For example, the smallest meaningful element of data is called a field by many hierarchical database management systems and indexed data access methods, but called a column by relational database management systems.

There are other cases in which a common concept is identified by a number of different terms. For simplicity, we use a single set of standardized terms. For example, we usually refer to the smallest meaningful element of data as a field, regardless of the type of data source. However, when required for clarity, we use the term specific to a given data source. Each time we introduce a new standard term, we define it and compare it to equivalent terms used with different types of data sources.

What Is a Data Source Description?

When your application accesses a data source, it needs to know how to interpret the data that it finds. Your application needs to know about:

- The overall structure of the data. For example, is the data relational, hierarchical, or sequential? Depending upon the structure, how is it arranged or indexed?
- The specific data elements. For example, what fields are stored in the data source, and what is the data type of each field (character, date, integer, or some other type)?

To obtain the necessary information, your application reads a data source description, also called a synonym. The primary component of a synonym is called a Master File. A Master File describes the structure of a data source and its fields. For example, it includes information such as field names and data types.

For some data sources, an Access File supplements a Master File. An Access File includes additional information that completes the description of the data source. For example, it includes the full data source name and location. You require one Master File and, for some data sources, one Access File to describe a data source.

How an Application Uses a Data Source Description

Master Files and Access Files are stored separately, apart from the associated data source. Your application uses a data source Master File (and if required, the corresponding Access File) to interpret the data source in the following way:

1. Identifies, locates, and reads the Master File for the data source named in a request.

If the Master File is already in memory, your application uses the memory image and then proceeds to locate and read the data source.

If the Master File is not in memory, the application locates the Master File on a storage device and loads it into memory, replacing any existing Master File in memory.

If your Master File references other data sources as cross-referenced segments, or if a JOIN command is in effect for this file, the cross-referenced Master Files are also read

into memory.

2. If there is a profile for the Master File, indicated by the presence of the MFD_PROFILE attribute in the FILE declaration, that profile is executed.
3. Reads the security rules if the Master File data source security (DBA) has been specified for the data source, and ensures that user access is allowed based on any DBA security specified.
4. Locates and reads the Access File for the data source named in the request, if that data source requires an Access File.
5. Locates and reads the data source.

The data source contents are interpreted based on the information in the Master File and, if applicable, the Access File.

i Note: You can encrypt a Master File using the ENCRYPT command described in [Hiding Restriction Rules: The ENCRYPT Command](#). However, the first line of a Master File that is going to be encrypted cannot be longer than 68 characters. If it is longer than 68 characters, you must break it up onto multiple lines.

What Does a Master File Describe?

A Master File enables you to:

- Identify the name and type of a data source.
- Identify and relate groups of fields.
- Describe individual fields.

i Note:

- Every Master File must contain at least one segment declaration and one field declaration. If a required attribute is not assigned a specific value, a comma must be used as a placeholder.
- The maximum number of segments supported in a structure is 1024. This structure can be created by joining or combining data sources.

The maximum number of segments in a single FOCUS data source is 64. XFOCUS data sources can have up to 512 segments. The maximum number of segments plus indices for a single FOCUS data source is 191.

- The total length of all fields can be up to 256K.

Identifying a Data Source

In order to interpret data, your application needs to know the name you are using to identify the data source and what type of data source it is. For example, is it a DB2 data source, an Oracle data source, or a FOCUS data source?

For more information, see [Identifying a Data Source](#).

Identifying and Relating a Group of Fields

A Master File identifies and relates groups of fields that have a one-to-one correspondence with each other. In Master File terms, a segment and in relational terms, a table.

You can join data sources of the same type (using a Master File or a JOIN command) and data sources of different types (using a JOIN command). For example, you can join two DB2 data sources to a FOCUS data source, and then to a VSAM data source.

For more information about defining and relating groups of fields, see [Describing a Group of Fields](#).

Describing a Field

Every field has several characteristics that you must describe in a Master File, such as type of data and length or scale. A Master File can also indicate optional field characteristics. For example, a Master File can specify if the field can have a missing value, and can provide descriptive information for the field.

A Master File usually describes all of the fields in a data source. In some cases, however, you can create a logical view of the data source in which only a subset of the fields is available, and then describe only those fields in your Master File.

For more information, see [Describing an Individual Field](#).

Creating a Data Source Description

You can create a Master File and Access File for a data source in several ways. If the data source:

- Has an existing description, such as a native schema or catalog, or a COBOL File Description. You can use a tool to automatically generate the Master File and Access File from the existing description.
- Does not have an existing description, you can create a Master File and (if required) an Access File by coding them using ibi™ WebFOCUS® data source description language, and specify their attributes using any text editor.

Creating a Master File and Access File Using an Editor

You can create a Master File and an Access File by:

- **Coding** them using a text editor. You can do this in all WebFOCUS® products. The information that you require about Master File syntax is contained in this documentation. For information about Access File syntax, see your data adapter documentation or [Describing a FOCUS Data Source](#).

After editing a Master File, issue the CHECK FILE command to validate the new

Master File and to refresh your session image.

- **Specifying** their attributes using the Master File Editor or the Synonym Editor. The Master File Editor is available in Maintain Data.

Creating a Master and Access File Using an Editor

Create a Master and Access File by coding them using a text editor. You can do this in all Information Builders products. The information that you require about Master File syntax is contained in this documentation. For information about Access File syntax, see your data adapter documentation or [Describing a FOCUS Data Source](#).

After editing a Master File, issue the CHECK FILE command to validate the new Master File and to refresh your session's image of it.

Naming a Master File

Master File names for FOCUS and fixed-format sequential data sources can be up to 64 characters long. Except where noted, this length is supported in all functional areas that reference a Master File.

Using Long Master File Names

File and member names are limited to eight characters. Therefore, longer Master File names are assigned eight-character names to be used when interacting with the operating system. Use the following to implement Master File names longer than eight characters:

- A LONGNAME option for the DYNAM ALLOCATE command, which creates the long Master File name and performs the allocation. This DYNAM option is described in [Allocate a Long Master File Name](#).
- An eight-character naming convention for member names associated with long Master File names. This convention is described in [Member Names for Long Master File Names](#).

- A long Master File attribute, \$ VIRT, which contains the long name to be used when interacting with the Master File and the operating system. This attribute is described in [Implement a Long Master File Name](#).

Member Names for Long Master File Names

The DYNAM ALLOC command with the LONGNAME option automatically creates a member for the long Master File name in the PDS allocated to ddname HOLDMAST.

The member name consists of three parts: a prefix consisting of the leftmost characters from the long name, followed by a left brace character ({}), followed by an index number. This naming convention is in effect for all long Master Files allocated using DYNAM or created using the HOLD command. The length of the prefix depends on how many long names have a common set of leftmost characters:

- The first ten names that share six or more leftmost characters have a six-character prefix and a one-character index number, starting from zero.
- Starting with the eleventh long name that shares the same leftmost six characters, the prefix becomes five characters, and the index number becomes two characters, starting from 00.

This process can continue until the prefix is one character and the index number is six characters. If you delete one of these members from the HOLDMAST PDS, the member name will be reused for the next new long name created with the same prefix.

Long Master File Names and Corresponding Member Names

The following table lists sample long names with the corresponding member names that would be assigned.

Long Name	Member Name
EMPLOYEES_ACCOUNTING	EMPLOY{0

Long Name	Member Name
EMPLOYEES_DEVELOPMENT	EMPLOY{1}
EMPLOYEES_DISTRIBUTION	EMPLOY{2}
EMPLOYEES_FINANCE	EMPLOY{3}
EMPLOYEES_INTERNATIONAL	EMPLOY{4}
EMPLOYEES_MARKETING	EMPLOY{5}
EMPLOYEES_OPERATIONS	EMPLOY{6}
EMPLOYEES_PERSONNEL	EMPLOY{7}
EMPLOYEES_PUBLICATIONS	EMPLOY{8}
EMPLOYEES_RESEARCH	EMPLOY{9}
EMPLOYEES_SALES	EMPLO{00}
EMPLOYEES_SUPPORT	EMPLO{01}

Implement a Long Master File Name

To relate the short name to its corresponding long name, the first line of a long Master File contains the following attribute

```
$ VIRT = long_filename
```

where:

long_filename

Is the long name, up to 64 characters in length.

Allocate a Long Master File Name

```
DYNAM ALLOC DD ddname LONGNAME long_filename DS physical_filename
```

where:

ddname

Is the one-character to eight-character member name in a PDS allocated to DD MASTER.

long_filename

Is the long Master File name. The DYNAM command creates a copy of the short Master File in the PDS allocated to DD HOLDMAST. The member in HOLDMAST conforms to the eight-character naming convention for long names. The Master File has the \$ VIRT attribute on the top line, which contains the long name.



Note: The copy, not the member ddname, is the Master File used when you reference the long name in a request.

physical_filename

Is the data set name of the FOCUS or fixed-format sequential data source.

After you have allocated the long name, you can reference the data source using the long Master File name or the short ddname.

Free an Allocation for a Long Master File Name

```
DYNAM FREE LONGNAME long_filename
```

where:

long_filename

Is the long Master File name.

After issuing the DYNAM FREE LONGNAME command, you cannot reference the data source using the long Master File name. However, you can reference it using the short ddname that was specified in the DYNAM ALLOC command.

Using a Long Master File Name

To reference the EMPLOYEE data source as EMPLOYEE_DATA, dynamically allocate the long name:

```
DYNAM ALLOC DD EMPLOYEE LONGNAME EMPLOYEE_DATA -
DS USER1.EMPLOYEE.FOCUS SHR REU
```

You can now issue a request using the long name:

```
TABLE FILE EMPLOYEE_DATA
PRINT CURR_SAL
BY LAST_NAME BY FIRST_NAME
END
```

The output is:

LAST_NAME	FIRST_NAME	CURR_SAL
-----	-----	-----
BANNING	JOHN	\$29,710.00
BLACKWOOD	ROSEMARIE	\$21,790.00
CROSS	BARBARA	\$27,072.00
GREENSPAN	MARY	\$9,010.00
IRVING	JOAN	\$26,872.00
JONES	DIANE	\$18,490.00
MCCOY	JOHN	\$18,490.00

MCKNIGHT	ROGER	\$16,110.00
ROMANS	ANTHONY	\$21,130.00
SMITH	MARY	\$13,210.00
	RICHARD	\$9,510.00
STEVENS	ALFRED	\$11,010.00

In this example, the long Master File will exist in the HOLDMAST PDS as member EMPLOY{0. The index number after the bracket depends on the number of existing long Master Files containing the same first six leftmost characters. The content of the EMPLOYEE_DATA Master File is virtually identical to the short Master File used in the allocation. The only difference is the \$ VIRT keyword on line one, which contains the long name. The FILENAME parameter also contains the long name, up to 64 characters.

```
$ VIRT=EMPLOYEE_DATA
$ Created from EMPLOYEE      MASTER
FILENAME=EMPLOYEE_DATA,
SUFFIX=FOC
SEGNAME=EMPINFO,  SEGTYPE=S1
  FIELDNAME=EMP_ID,    ALIAS=EID,  FORMAT=A9,  $
  FIELDNAME=LAST_NAME, ALIAS=LN,  FORMAT=A15, $
  .
  .
  .
```

Usage Notes for Long Master File Names

- The FOCUS Database Server (FDS) is not supported on any platform.
- The DATASET attribute is not supported in a long name Master File.
- The ACCESSFILE attribute is not supported with long name Master Files.
- An external index is not supported.
- The LONGNAME option of the DYNAM command may only be issued from within a procedure (FOCEXEC) or Remote Procedure Call (RPC). It cannot be used to preallocate long Master Files in JCL or CLISTS.
- Long Master Files are not designed to be edited. Each time the DYNAM command is issued with the LONGNAME attribute, it overlays the existing member in HOLDMAST. You must make any edits (such as the addition of fields or DBA attributes, or use of

the REBUILD utility) to an existing short Master File.

- ? FDT and ? FILE *longfilename* will show an internal DD alias of @000000*n*, where *n* is less than or equal to the number of existing long file allocations. Use this internal DDNAME in all queries that require a valid DDNAME, such as USE commands.

What Is in a Master File?

A Master File describes a data source using a series of declarations:

- A data source declaration.
- A segment declaration for each segment within the data source.
- A field declaration for each field within a segment.
- Declarations for other objects that can be optionally added to the data source description, such as FILTER, DEFINE, COMPUTE, and SORTOBJ definitions.

The specifications for an Access File are similar, although the details vary by type of data source. The appropriate documentation for your adapter indicates whether you require an Access File and, if so, what the Access File attributes are.

Specify a Declaration

Each declaration specifies a series of attributes in the form

```
attribute = value, attribute = value, ... , $
```

where:

attribute

Is a Master File keyword that identifies a file, segment, or field property. You can specify any Master File attribute by its full name, its alias, or its shortest unique truncation. For example, you can use the full attribute FILENAME or the shorter form FILE.

value

Is the value of the attribute.

A comma follows each attribute assignment, and each field declaration ends with a dollar sign (\$). Commas and dollar signs are optional at the end of data source and segment declarations.

Each declaration should begin on a new line. You can extend a declaration across as many lines as you want. For a given declaration you can put each attribute assignment on a separate line, combine several attributes on each line, or include the entire declaration on a single line.

- For more information on data source declarations, see [Identifying a Data Source](#).
- For more information on segment declarations, see [Describing a Group of Fields](#).
- For more information on field declarations, see [Describing an Individual Field](#).

**Note:**

In a Master File, the attribute name must be in English. The attribute value can be in any supported national language.

Improving Readability

Begin each attribute assignment in any position. You can include blank spaces between the elements in a declaration. This makes it easy for you to indent segment or field declarations to make the Master File easier to read.

You can also include blank lines to separate declarations. Blank spaces and lines are not required and are ignored by the application.

Improving Readability With Blank Spaces and Blank Lines

The following declarations show how to improve readability by adding blank spaces and blank lines within and between declarations:

```
SEGNAME=EMPINFO, SEGTYPE=S1 , $  
FIELDNAME=EMP_ID, ALIAS=EID, USAGE=A9 , $
```

```
SEGNAME=EMPINFO, SEGTYPE=S1 , $
  FIELDNAME = EMP_ID, ALIAS = EID, USAGE = A9 , $
```

```
SEGNAME=EMPINFO, SEGTYPE=S1, $
  FIELDNAME = EMP_ID, ALIAS = EID, USAGE = A9 , $
```

Improving Readability by Extending a Declaration Across Lines

The following example extends a field declaration across several lines:

```
FIELDNAME = MEMBERSHIP, ALIAS = BELONGS, USAGE = A1, MISSING = ON,
  DESCRIPTION = This field indicates the applicant's membership status,
  ACCEPT = Y OR N, FIELDTYPE = I,
  HELPMESSAGE = 'Please enter Y for Yes or N for No' , $
```

Adding a Comment

You can add comments to any declaration by:

- Typing a comment in a declaration line after the terminating dollar sign.
- Creating an entire comment line by placing a dollar sign at the beginning of the line.

Adding a comment line terminates the previous declaration if it has not already been terminated. Everything on a line following the dollar sign is ignored.

Comments placed after a dollar sign are useful only for those who view the Master File source code.

Adding a Comment in a Master File

The following example contains two comments. The first comment follows the dollar sign on the data source declaration. The second comment is on a line by itself after the data source declaration.

```
FILENAME = EMPLOYEE, SUFFIX = FOC , $ This is the personnel data source.  
$ This data source tracks employee salaries and raises.  
SEGNAME = EMPINFO, SEGTYPE = S1 , $
```

Editing and Validating a Master File

After you manually create or edit a Master File, you should issue the CHECK FILE command to validate it. CHECK FILE reads the new or revised Master File into memory and highlights any errors in your Master File so that you can correct them before reading the data source.

The CHECK FILE PICTURE command displays a diagram illustrating the structure of a data source. You can also use this command to view information in the Master File, such as names of segments and fields, and the order in which information is retrieved from the data source when you run a request against it.

For more information, see [Checking and Changing a Master File: CHECK](#).

Identifying a Data Source

In order to interpret data, your application needs to know the name you are using to identify the data source and what type of data source it is. For example, is it a DB2 data source, a Teradata data source, or a FOCUS data source?

Identifying a Data Source Overview

In a Master File, you identify the name and the type of data source in a data source declaration. A data source declaration can include the following attributes:

- FILENAME, which identifies the name of the data source.
- SUFFIX, which identifies the type of data source.
- REMARKS, which allows you to provide descriptive information about the data source for display in graphical tools.
- ACCESSFILE, which identifies the name of the optional Access File for a FOCUS data source. See [Describing a FOCUS Data Source](#).
- DATASET, which identifies the physical file name if your data source has a non-standard name.

You can identify a Master File profile (MFD_PROFILE) procedure to run during Master File processing. For more information, see [Creating and Using a Master File Profile](#).

You can optionally specify a sliding date window that assigns a century value to dates stored with two-digit years, using these data source attributes:

- FDEFCENT, which identifies the century.
- FYRTHRESH, which identifies the year.

For more information on the sliding window technique, see the *Developing Applications* manual.

Specifying a Data Source Name: FILENAME

The FILENAME attribute specifies the name of the data source described by the Master File. This is the first attribute specified in a Master File. You can abbreviate the FILENAME attribute to FILE.

i Note: You can encrypt a Master File using the ENCRYPT command described in [Hiding Restriction Rules: The ENCRYPT Command](#). However, the first line of a Master File that is going to be encrypted cannot be longer than 68 characters. If it is longer than 68 characters, you must break it up onto multiple lines.

Specify a Data Source Name

```
FILE[NAME] = data_source_name
```

where:

data_source_name

Is the name of the data source that the Master File describes. The name can be a maximum of 64 characters. For information about using names greater than eight characters, see [Naming a Master File](#).

The file name must contain at least one alphabetic character, and the remaining characters can be any combination of letters, numbers, and underscores (_). The file name must start with an alphabetic character.

Specifying a Data Source Name

The following example specifies the data source name EMPLOYEE:

```
FILENAME = EMPLOYEE
```

Identifying a Data Source Type: SUFFIX

The SUFFIX attribute identifies the type of data source you are using. For example, a DB2 data source or a FOCUS data source. Based on the value of SUFFIX, the appropriate data adapter is used to access the data source.

The SUFFIX attribute is required for most types of data sources. It is optional for a fixed-format sequential data source. However, if you refer to a fixed-format sequential data source in a JOIN command, then the SUFFIX attribute must be declared in the Master File.

i Note: Maintain Data does not support the following suffixes: COMT, TABT, and XFOCUS.

You can create your own data access module for any non-standard data source that cannot be described using a standard Master File. In this case you would assign the name of the data access module to the SUFFIX attribute in the Master File.

Identify a Data Source Type

```
SUFFIX = data_source_type
```

where:

data_source_type

Indicates the type of data source or the name of a customized data access module. The default value is FIX, which represents a fixed-format sequential data source.

Specifying the Type for a FOCUS Data Source

The following example specifies the data source type FOC, representing a FOCUS data source which has 4K database pages:

```
SUFFIX = FOC
```

The following example specifies the data source type XFOCUS, representing an XFOCUS data source which has 16K database pages:

SUFFIX = XFOCUS

SUFFIX Values

The following table indicates the SUFFIX value for many of the supported data source types:

Data Source Type	SUFFIX Value
ADABAS	ADBSIN or ADBSINX
ALLBASE/SQL	SQLALB or ALLBASE
CA-Datcom/DB	DATACOM
CA-IDMS/DB	IDMSR
CA-IDMS/SQL	SQLIDMS
C-ISAM	C-ISAM
DB2	DB2 or SQLDS
DB2/2	SQLDBM
DB2/400	SQL400 (SQL access)

Data Source Type	SUFFIX Value
	DBFILE (native access)
DB2/6000	DB2
DBMS	DBMS
Digital Standard MUMPS	DSM
Enscribe	ENSC
Fixed-format sequential	<u>FIX</u> This value is the default. PRIVATE (for FOCSAM user exit)
FOCUS	FOC
Free-format (also known as comma-delimited) sequential	COM, COMMA, COMT
IMS	IMS
INFOAccess	SQLIAX
Information/Management	INFOMAN
Informix	SQLINF

Data Source Type	SUFFIX Value
Ingres	SQLING
KSAM	KSAM
Micronetics Standard MUMPS	MSM
Model 204	M204IN
Native Interface	SQLSAP
NETISAM	C-ISAM
NOMAD	NMDIN
Nucleus	SQLNUC
ODBC	SQLODBC
OpenIngres	SQLING
Open M/SQL	SQLMSQ

Data Source Type	SUFFIX Value
Oracle	SQLORA
Progress	SQLPRO
Rdb	SQLRDB
Red Brick	SQLRED
RMS	RMS
SQL/DS	SQLDS
SQL Server	SQLMSS
StorHouse	SQLSTH
Sybase	SQLSYB
Tab Delimited	TABT, TAB
Teradata	SQLDBC

Data Source Type	SUFFIX Value
Token Delimited	DFIX
Unify	SQLUNIFY
uniVerse	UNIVERSE
VSAM	VSAM PRIVATE (for FOCSAM user exit)
XFOCUS	XFOCUS
Non-standard data source	Name of the customized data access routine

Specifying a Code Page in a Master File

The FILE declaration in a Master File can specify the code page to be used to retrieve the data in that file. If the file is included as a segment in a cluster join, having the code page specified ensures that the data from that segment is retrieved using the correct code page even if the FILE declaration for the cluster specifies a different code page or defaults to the default code page.

Specify a Code Page for a Master File

CODEPAGE = codepage

where:

codepage

Is the code page to use to read the file.

Specifying Byte Order

Operating environments differ in whether the most-significant or least-significant byte is ordered first when storing numeric data. Ordering the most significant byte first is called *big-endian* (BE), and ordering the least significant byte first is called *small-endian* (SE).

You may need to specify the byte order in the Master File if you are reading data from a different operating environment.

Specify Byte Order

```
BYTEORDER={BE | SE}
```

where:

BE

Specifies that the most significant byte is ordered first. Hardware using this order includes IBM zSeries and POWER.

SE

Specifies that the least significant byte is ordered first, also called *reverse byte*. Hardware using this order includes Intel x86, x86-64, and DEC Alpha.

Specifying Data Type: IOTYPE

IOTYPE is generated when a HOLD file is created to tell FOCUS how to read the data file in the absence of LRECL/RECFM information from a FILEDEF or allocation. It indicates the type of data that was included in the file when the hold file was created. It is only recommended for Master Files generated automatically as a result of a HOLD command. The values can be:

- **BINARY.** Numeric data is stored in binary format in the generated file.
- **STREAM.** All data in the generated file is in alphanumeric format.

IOTYPE applies only to the following HOLD formats:

FORMAT	SUFFIX	IOTYPE
ALPHA	FIX	STREAM
BINARY	FIX	BINARY
INTERNAL	FIX	BINARY
no format	FIX	Depends on the HOLDFORMAT parameter. If HOLDFORMAT is: <ul style="list-style-type: none"> • BINARY, then IOTYPE is BINARY. • ALPHA, then IOTYPE is STREAM.

Providing Descriptive Information for a Data Source: REMARKS

The optional REMARKS attribute provides descriptive information about the data source.

You can also include descriptive information as a comment following a \$ symbol in the Master File. For more information, see [Understanding a Data Source Description](#).

Master Files support REMARKS and DESCRIPTION attributes in multiple languages. For more information, see [Using Multilingual Descriptions in a Master File](#).

Document a Data Source

```
REMARKS = 'descriptive_text'
```

where:

descriptive_text

Is descriptive information about the data source. The text can be a maximum of 2K characters long and must be enclosed within single quotation marks.

The descriptive text cannot span more than one line in the Master File. If necessary, place the entire REMARKS attribute on a line by itself. For longer descriptions, break the declaration into lines with the descriptive text on a line by itself.

Providing Descriptive Information for an Oracle Table

The following example shows the data source declaration for the Oracle table ORDERS. The data source declaration includes descriptive information about the table.

```
FILENAME=ORDERS, SUFFIX=SQLORA,  
REMARKS='This Oracle table tracks daily, weekly, and monthly orders.' , $
```

Since the descriptive information would not fit on the same line as the other data source attributes, the REMARKS attribute appears on a line by itself.

Specifying a Physical File Name: DATASET

You can add the DATASET attribute to the Master File to specify a physical location for the data source to be allocated. In addition, the DATASET attribute permits you to bypass the search mechanism for the default data source location. DATASET eliminates the need to allocate data sources using JCL, FILEDEF, DYNAM, and USE commands.

For z/OS, the user allocation command is DYNAM ALLOC or TSO ALLOC.

For UNIX and Windows, the user allocation command is FILEDEF.

DATASET can also be included in a HOLD command, which can include DATASET as one of its options. The Master File generated by the HOLD command includes the DATASET attribute at the file level. For information about the HOLD command, see the *FOCUS® Creating Reports manual*.

i Note:

- The MODIFY FIND function does not work with the DATASET attribute. To use FIND with a data source, you must explicitly allocate the data source.
- You cannot use both the ACCESSFILE attribute and the DATASET attribute in the same Master File. For information on the ACCESSFILE attribute, see [Describing a FOCUS Data Source](#).

DATASET Behavior in a FOCUS Data Source

You can use the DATASET attribute on the file level of a FOCUS (including XFOCUS), fixed-format sequential, or VSAM Master File. You can use the DATASET attribute on the segment level of a FOCUS Master File. For information on specifying the DATASET attribute on the segment level of a FOCUS Master File, see [Describing a FOCUS Data Source](#).

If the Master File name is present in the USE list, or the user explicitly allocated the data file, the DATASET attribute is ignored.

If DATASET is used in a Master File whose data source is managed by the FOCUS Database Server, the DATASET attribute is ignored on the server side because the FOCUS Database Server does not read Master Files for servicing table requests.

The DATASET attribute in the Master File has the lowest priority:

- An explicit allocation of a user overrides the DATASET attribute if you first issue the allocation command and then issue a CHECK FILE command to clear the previous DATASET allocation.
- The USE command for FOCUS data sources overrides DATASET attributes and explicit allocations.

An alternative to the DATASET attribute for allocating FOCUS data sources is an Access File. For detailed information, see [Describing a FOCUS Data Source](#).

- i Note:** If a DATASET allocation is in effect, a CHECK FILE command must be issued in order to override it by an explicit allocation command. The CHECK FILE command will undo the allocation created by DATASET.

Use the DATASET Attribute at the File Level

```
{DATASET|DATA}='filename [ON sinkname]'
```

In z/OS, the syntax is:

```
{DATASET|DATA}='qualifier.qualifier ...'
```

or

```
{DATASET|DATA}='ddname ON sinkname'
```

In UNIX, the syntax is:

```
{DATASET|DATA}='/filesystem/filename.foc [ON sinkname]'
```

In Windows, the syntax is:

```
{DATASET|DATA}='drive:\directory\filename.foc [ON sinkname]'
```

where:

filename

Is the platform-dependent physical name of the data source.

sinkname

Indicates that the data source is located on the FOCUS Database Server. This attribute is valid only for FOCUS or XFOCUS data sources.

Allocating a FOCUS Data Source Using the DATASET Attribute

The following example illustrates how to allocate a FOCUS data source using the DATASET attribute.

For z/OS,

```

FILENAME=CAR, SUFFIX=FOC,
DATASET='USER1.CAR.FOCUS'
SEGNAME=ORIGIN, SEGTYPE=S1
FIELDNAME=COUNTRY, COUNTRY, A10, FIELDTYPE=I, $
SEGNAME=COMP, SEGTYPE=S1, PARENT=ORIGIN
FIELDNAME=CAR, CARS, A16, $
SEGNAME=CARREC, SEGTYPE=S1, PARENT=COMP
.
.
.

```

For UNIX,

```

FILENAME=CAR, SUFFIX=FOC,
DATASET='/filesystem/filename.foc'
SEGNAME=ORIGIN, SEGTYPE=S1
FIELDNAME=COUNTRY, COUNTRY, A10, FIELDTYPE=I, $
SEGNAME=COMP, SEGTYPE=S1, PARENT=ORIGIN
FIELDNAME=CAR, CARS, A16, $
SEGNAME=CARREC, SEGTYPE=S1, PARENT=COMP
.
.
.

```

For Windows,

```

FILENAME=CAR, SUFFIX=FOC,
DATASET='drive:\directory\filename.foc'
SEGNAME=ORIGIN, SEGTYPE=S1
FIELDNAME=COUNTRY, COUNTRY, A10, FIELDTYPE=I, $
SEGNAME=COMP, SEGTYPE=S1, PARENT=ORIGIN
FIELDNAME=CAR, CARS, A16, $
SEGNAME=CARREC, SEGTYPE=S1, PARENT=COMP
.
.
.

```

Allocating a Data Source for the FOCUS Database Server

The following example illustrates how to allocate a FOCUS data source with the DATASET attribute using ON *sink*.

For z/OS,

```
FILENAME=CAR,SUFFIX=FOC,
DATASET='CAR ON SINK1'
SEGNAME=ORIGIN,SEGTYPE=S1
FIELDNAME=COUNTRY,COUNTRY,A10,FIELDTYPE=I,$
SEGNAME=COMP,SEGTYPE=S1,PARENT=ORIGIN
FIELDNAME=CAR,CARS,A16,$
SEGNAME=CARREC,SEGTYPE=S1,PARENT=COMP
.
.
.
```



Note: The ddname CAR is allocated by the FOCUS Database Server JCL.

For UNIX,

```
FILENAME=CAR,SUFFIX=FOC, DATASET='filename ON sink'
SEGNAME=ORIGIN,SEGTYPE=S1
FIELDNAME=COUNTRY,COUNTRY,A10,FIELDTYPE=I,$
SEGNAME=COMP,SEGTYPE=S1,PARENT=ORIGIN
FIELDNAME=CAR,CARS,A16,$
SEGNAME=CARREC,SEGTYPE=S1,PARENT=COMP
.
.
.
```

For Windows,

```
FILENAME=CAR,SUFFIX=FOC,
DATASET='filename ON sink'
SEGNAME=ORIGIN,SEGTYPE=S1
FIELDNAME=COUNTRY,COUNTRY,A10,FIELDTYPE=I,$
```

```
SEGNAME=COMP, SEGTYPE=S1, PARENT=ORIGIN  
FIELDNAME=CAR, CARS, A16, $  
SEGNAME=CARREC, SEGTYPE=S1, PARENT=COMP  
.  
.  
.
```

DATASET Behavior in a Fixed-Format Sequential Data Source

The DATASET attribute for a fixed-format sequential file can be used only at the file declaration level of the Master File and cannot contain ON *sink*. If the DATASET attribute contains ON *sink*, a message is issued and the operation is terminated.

An explicit allocation of data for this Master File is checked for when the DATASET attribute is detected. If an explicit allocation exists, the DATASET attribute is ignored. If this Master File name is not allocated, an internal command is issued to perform the allocation. This allocation is stored temporarily and is released when a new Master File is used or when the session terminates.

There is a second parameter for DATASET, required for the UNIX\ and Windows platforms, which when used with SUFFIX=FIX data sources, tells whether it contains binary or text data. This parameter provides information on whether there are line break characters in the data source. This distinguishes a text data source from a binary data source. The default is binary.

Use the DATASET Attribute With a Fixed-Format Data Source

```
{DATASET|DATA}='filename {BINARY|TEXT}'
```

where:

filename

Is the platform-dependent physical name of the data source.

BINARY

Indicates that it is a binary data source. BINARY is the default value.

TEXT

Indicates that it is a text data source.

The DATASET attribute in the Master File has the lowest priority. An explicit allocation of a user overrides DATASET attributes.

i Note: If a DATASET allocation is in effect, a CHECK FILE command must be issued to override it by an explicit allocation command. The CHECK FILE command deallocates the allocation created by DATASET.

Allocating a Fixed-Format Data Source Using the DATASET Attribute

The following examples illustrate how to allocate a fixed-format data source using the DATASET attribute.

For z/OS:

```
FILE=XX,  SUFFIX=FIX,  DATASET='USER1.SEQFILE1'  
.  
.  
.
```

For Windows:

```
FILE=XX,  SUFFIX=FIX,  DATASET='C:\DATA\FILENAME.FTM  TEXT'  
.  
.  
.
```

For UNIX:

```
FILE=XX,  SUFFIX=FIX,  DATASET='/u22/class/data/filename.ftm'  
.  
.  
.
```

For a binary data source:

```
FILE=XX,  SUFFIX=FIX,  DATASET='/u22/class/data/filename.ftm  BINARY'  
.  
.  
.
```

DATASET Behavior in a VSAM Data Source

The DATASET attribute for a VSAM data source can be used on the file declaration level of the Master File and cannot contain ON *sink*. If the DATASET attribute contains ON *sink*, a message is issued and the operation is terminated.

An explicit allocation of data for this Master File is checked for when the DATASET attribute is detected. If an explicit allocation is found, the DATASET attribute is ignored. If this Master File name is not allocated, an internal command is issued to perform the allocation. This allocation is stored temporarily and is released when a new Master File is used or when the session terminates.

The DATASET attribute may also appear on the field declaration level of the Master File to specify where to find an alternate index. Because of VSAM naming conventions (names are truncated to 8 characters), the name of the field alias will be used as the ddname. If a user allocation is found for the Master File or alternate index ddname, the DATASET attribute is ignored.

i Note: There is no limit on how many alternate indices you may have. It is also acceptable for some alternate indices to have the DATASET attribute while others do not. However, if a file level DATASET attribute is missing, the field level DATASET will be ignored.

Use the DATASET Attribute With a VSAM, ISAM, or C-ISAM Data Source

```
{DATASET|DATA}='filename'
```

where:

filename

Is the platform-dependent physical name of the data source or alternate index.

The DATASET attribute in the Master File has the lowest priority. An explicit allocation of a user overrides DATASET attributes.

i Note: If a DATASET allocation is in effect, a CHECK FILE command must be issued in order to override it by an explicit allocation command. The CHECK FILE command deallocates the allocation created by DATASET.

Allocating a VSAM Data Source Using the DATASET Attribute

The following example illustrates how to allocate a VSAM data source on the file declaration level and for an alternate index:

```
FILE=EXERVSM1, SUFFIX=VSAM, DATASET='VSAM1.CLUSTER1', $
SEGNAME=ROOT, SEGTYPE=S0, $
GROUP=KEY1, ALIAS=KEY, FORMAT=A4, ACTUAL=A4, $
FIELD=FLD1, ALIAS=F1, FORMAT=A4, ACTUAL=A4, $
FIELD=FLD2, ALIAS=F2, FORMAT=A4, ACTUAL=A4, $
FIELD=FLD3, ALIAS=DD1, FORMAT=A4, ACTUAL=A4, FIELDTYPE = I,
DATASET='VSAM1.INDEX1', $
FIELD=FLD4, ALIAS=F4, FORMAT=A4, ACTUAL=A4, $
FIELD=FLD5, ALIAS=F5, FORMAT=A4, ACTUAL=A4, $
FIELD=FLD6, ALIAS=F6, FORMAT=A4, ACTUAL=A4, $
FIELD=FLD7, ALIAS=F7, FORMAT=A4, ACTUAL=A4, $
```

Allocating a C-ISAM Data Source Using the DATASET Attribute

The following example illustrates how to allocate a C-ISAM data source on the file declaration level and for an alternate index:

```
FILENAME=EMPLOYEE, SUFFIX=CISAM ,
DATASET=/qa/edamvt/CISAM/employee, $
SEGMENT=SEG1, SEGTYPE=S0, $
GROUP=G5, ALIAS=KEY, ELEMENTS=1, $
FIELDNAME=EMPLOYEE_ID5, ALIAS=E3, USAGE=I11, ACTUAL=I4, $
FIELDNAME=SSN5, ALIAS=KEY1, USAGE=A11, ACTUAL=A11, FIELDTYPE=I,$
FIELDNAME=FILLER, ALIAS=E5, USAGE=A1, ACTUAL=A1, $
FIELDNAME=LAST_NAME5, ALIAS=E6, USAGE=A20, ACTUAL=A20, $
FIELDNAME=FIRST_NAME5, ALIAS=E7, USAGE=A15, ACTUAL=A15, $
FIELDNAME=FILLER, ALIAS=E8, USAGE=A1, ACTUAL=A1, $
FIELDNAME=BIRTHDATE5, ALIAS=E9, USAGE=I11, ACTUAL=I4, $
FIELDNAME=SEX5, ALIAS=E10, USAGE=A1, ACTUAL=A1, $
FIELDNAME=FILLER, ALIAS=E11, USAGE=A3, ACTUAL=A3, $
FIELDNAME=ETHNIC_GROU5, ALIAS=E12, USAGE=A15, ACTUAL=A15, $
FIELDNAME=FILLER, ALIAS=E13, USAGE=A1, ACTUAL=A1, $
FIELDNAME=STREET5, ALIAS=E14, USAGE=A20, ACTUAL=A20, $
FIELDNAME=CITY5, ALIAS=E15, USAGE=A15, ACTUAL=A15, $
FIELDNAME=FILLER, ALIAS=E16, USAGE=A1, ACTUAL=A1, $
```

Storing Localized Metadata in Language Files

If you want to centralize localized column titles, descriptions, and prompts, and apply them to multiple Master Files, you can create a set of translation files and use the TRANS_FILE attribute in a Master File to invoke them. You can set up the files totally manually, or you can use the LNGPREP utility to prepare the files for translation.

LNGPREP Utility: Preparing Metadata Language Files

The LNGPREP utility extracts TITLE, DESCRIPTION, CAPTION, and PROMPT attribute values from application Master Files into specially formatted language translation files for each

language you need. Once you have the contents of these language files translated, your users can run these applications in the language they select.

LNGPREP does two things. It extracts attribute values from a Master File into language files, and it inserts or updates the TRANS_FILE attribute in the Master File with a value identifying the application folder where the language files reside and a prefix used for naming the set of language files. If the Master File is part of a cluster, LNGPREP will extract translatable strings from every Master File referenced in the cluster, and will update each with the same TRANS_FILE value.

LNGPREP requires an input file listing the three-character codes of the languages you need.

The name of each language file starts with the prefix specified in the TRANS_FILE value, followed by a three-character language code, and the extension *.lng*.

For example, assume the language input file contains the French and Spanish language codes:

```
fre
spa
```

If the Master File specifies:

```
trans_file = xlate/xl_
```

The language translation files would be in the **xlate** application folder, named:

- xl_fre.lng for French.
- xl_spa.lng for Spanish.

The Base Language File

Each Master File must have a single base language in which the DESCRIPTION, TITLE, CAPTION, and PROMPT attributes are specified. This language does not need to be English.

LNGPREP extracts these attribute values into the base language file, whose language code, for historical reasons, is *eng*. In this case, *eng* does not mean English. It means whatever language the Master File is written in.

The base language file (*prefixeng.lng*) should never be hand edited. All other lng files must be hand edited by translators, to translate the string values from the base language to the appropriate language.

Translating Applications into English

Since language code *eng* is reserved to mean base language, you cannot use it to contain English translations of an application whose base language is not English. In those cases, use any of the other English dialect language codes, such as AME, UKE, CAE, or AUE. For example, if the base language is German, specify AME in the languages file, run LNGPREP, and it will produce *prefixeng.lng* and *prefixame.lng* files, both in German. Translate the contents of *prefixame.lng* into English. Leave *prefixeng.lng* untouched.

How Translated Master File Attributes Display

Each language file contains a line for each attribute value from a related set of Master Files. Each attribute value has a unique index number assigned to it. For example, if the Master File contains FIELDNAME=PRODUCT_CATEGORY, TITLE='Product,Category', and that TITLE happens to be the 39th translatable attribute value, LNGPREP will produce lng files all containing the line:

```
39 = Product,Category
```

Your French translator will edit *prefixfre.lng*, leaving the index values unchanged while translating the string values, producing, in this case,

```
39 = Produit,Catégorie
```

At run time, when the TITLE for field PRODUCT_CATEGORY needs to be displayed, if FOCUS is configured for LANG=FRE, FOCUS looks up "Product,Category" in *prefixeng.lng*, finds index value 39, looks up 39 in *prefixfre.lng*, and displays the TITLE as "Produit,Catégorie."

LNGPREP Prerequisites

You must first create a configuration file containing the three-character language codes for each translation file you need, one language code on each line. The first invocation of LNGPREP for a given Master File adds the TRANS_FILE attribute in that and all related

Master Files, creates the base language file by scanning the Master Files for supported attribute values, and creates a copy of the base language file with the correct name for each additional language. Then, a translator has to translate the values in each additional language file from the base language to the correct language for that file.

On each subsequent run, LNGPREP will check for updates to the list of related Master Files and attribute values and update the files as needed. Translators will then have to translate any attribute values added to the language files.

LNGPREP Best Practice

The recommended best practice is to create an app directory solely for the purpose of containing .lng files, and use this appname and a common prefix value for all LNGPREP commands. In addition, put the languages *fn.cfg* file in this app folder. This will create one set of .lng files for all apps, minimizing the time and effort spent on translation.

Prepare Metadata Language Files Using the Web Console

Procedure

1. Right-click a synonym, point to **Metadata Management**, then click **Prepare Translation Files**, as shown in the following image.

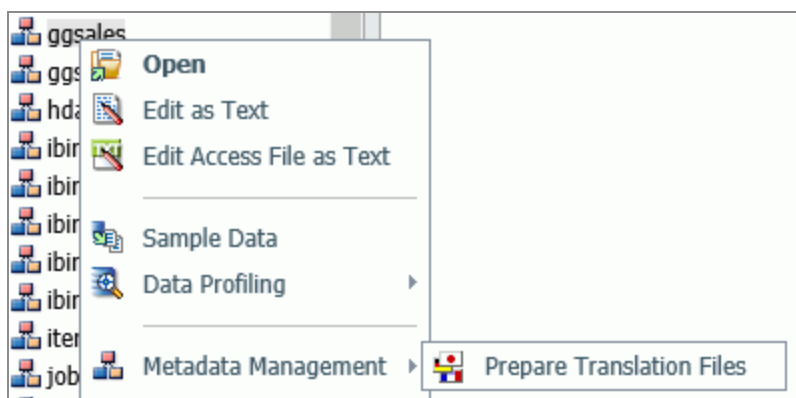

The Set Translation Files page opens, as shown in the following image.

2. Enter the following values or accept the defaults.

Application for Translation Files

Is the name of the application where the language files will be stored. You can click the ellipsis to select an application from the current application path. By default, it is the application where the synonym resides.

Prefix

Is the prefix value for the translation files for the selected synonym.

Languages File

Is the file containing the list of language codes for which translation files should be prepared. The file must have the extension .cfg, be stored in an application directory on the application path, and have one language code on each line. You can click the ellipsis to select the application where the languages file is stored.

3. Click **OK**.

The language files are prepared using the application, prefix, and languages configuration file you specified. A status page will open listing the language files created and the Master Files processed.

Run the LNGPREP Command Using Syntax

```
LNGPREP FILE n_part_name LNGAPP appname LNGPREFIX prefix
          LNGFILE appname/fn
```

where:

n_part_name

Specifies the n-part (app1/app2...) name of a Master File.

appname

Specifies the location where .lng files will be written and updated.

prefix

Specifies the literal characters that will precede the three-character language code in the names of the .lng files.

appname/fn

Specifies the *appname* and *filename* of a user-created .cfg file containing the list of three-character language codes, one per line. For example, the following file named langretail.cfg contains language codes for American English, French, and Japanese:

```
ame
fre
jpn
```

Sample LNGPREP Command

Assume the lnglist.cfg file contains the language codes fre (French) and spa (Spanish):

```
fre
spa
```

Issue the following LNGPREP command:

```
LNGPREP FILE weather/forecast LNGAPP xlate LNGPREFIX tq_ LNGFILE
xlate/lnglist
```

Set Translation Files for weather/forecast.mas

Application for Translation Files:

Prefix:

Languages File:

The following language files will be created:

- xlate/tq_eng.lng
- xlate/tq_fre.lng
- xlate/tq_spa.lng

The Master File weather/forecast.mas will be updated with the following attribute:

```
TRANS_FILE= xlate/tq_
```

Translators then have to translate the values in xlate/tq_fre.lng and xlate/tq_spa.lng.

Creating and Using a Master File Profile

This release introduces a profile that you can reference in the Master File and is executed during Master File processing. The Master File profile (MFD_PROFILE) is a FOCEXEC that suspends processing of the Master File for a request, executes, and then returns to processing of the Master File. The profile can be used for many purposes but is especially useful for:

- Setting the values of global variables defined in the Master File.
- Creating a lookup file for Master File DEFINE commands or DBA attributes.
- Dynamically creating a DBA rule for the connected user by reading an external table of entitlements.
- Dynamically creating a DBAFILE, which can be derived from an external data source and used to restrict access during execution of any request that references the Master File.

i Note: You can also create a DBA rule dynamically in the Master File for a specific user without having to create a DBAFILE with rules for all users.

Invoke a Master File Profile

Add the MFD_PROFILE attribute to the FILE declaration in the Master File:

```
FILE = filename, SUFFIX = suffix, MFD_PROFILE = app/fexname,$
```

where:

filename

Is any valid file name.

suffix

Is the suffix value that specifies the file type described by the Master File. MFD_PROFILE is supported for any file type.

app

Is the name of the application containing the FOCEXEC to be executed. Specifying the application name ensures that the correct version of the profile is executed, in case there is another FOCEXEC with the same name higher on the application path.

fexname

Is the name of the MFD_PROFILE FOCEXEC.

Usage Notes for MFD_PROFILE

- The MFD_PROFILE is executed for every TABLE, TABLEF, MATCH, GRAPH, CREATE, DEFINE, CHECK, ?F, and ?FF request against a Master File that contains the MFD_PROFILE attribute.

In a MATCH request or a request using MORE, all of the MFD_PROFILE procedures specified in any of the Master Files involved in the request will be executed prior to the request. The profiles will execute in the reverse of their order in the request (the profile for the Master File mentioned last in the request executes first).

- The MFD_PROFILE is not executed as a result of the MODIFY, MAINTAIN, or -READFILE commands.
- If multiple MFD_PROFILES set values for the same global variables, the resulting variable values will depend on the order in which the profile procedures run.
- In a join between multiple Master Files that have MFD_PROFILE attributes, the profiles will all be executed.
- The name of the calling Master File is passed as the first parameter (&1) to the MFD_PROFILE procedure.

- If the MFD_PROFILE contains sensitive information, it should be encrypted. If it creates a file (such as a DBAFILE) that contains sensitive information, that file should also be encrypted.
- If the MFD_PROFILE is not on the application path, the following warning message will be issued.

```
FOC(36373)  WARNING: MFD_PROFILE DOES NOT EXIST
```

If you want the lack of the profile to terminate processing, turn the ERROROUT parameter to ON.

- The MFD_PROFILE procedure should not issue a request against its calling Master File, unless you add a counter to make sure it executes only once. Otherwise, an infinite loop will result. If there is a reason why the MFD_PROFILE needs to execute a request against itself, add a global Dialogue Manager variable as a counter to make sure it is executed only once, as shown in the following sample.

```
-DEFAULT &&COUNTER=1;
-IF &&COUNTER EQ 1 THEN GOTO START;
-SET &&COUNTER= 2;
-GOTO DONE
-START
MFD_PROFILE request against same Master as original request END
-SET &&COUNTER=2;
-DONE
```

The first time the MFD_PROFILE is invoked, &&COUNTER is set to 1, so the part of the MFD_PROFILE request that references the same Master File is executed, and &&COUNTER is set to 2. Since executing this request references the Master with the MFD_PROFILE, it is invoked again. However, since &&COUNTER will now be 2, the MFD_PROFILE request will branch around the part that once again references the same Master File, preventing the MFD_PROFILE from being invoked in an infinite loop.

- A request against a Business View will invoke the MFD_PROFILE from the original Master File.
- If the MFD_PROFILE creates a DBAFILE, an initial DBAFILE specifying authorized users and any restrictions at the SEGMENT or FIELD level must exist prior to using commands other than TABLE, TABLEF, GRAPH or MATCH. The initial DBAFILE may be created without VALUE restrictions. When the actual TABLE request runs, or you click

Run from a tool, the MFD_PROFILE procedure is executed, and VALUE restrictions are applied.

- Be careful not to issue any command that affects the environment that was established prior to executing the MFD_PROFILE. For example, if the MFD_PROFILE establishes any joins that you want to clear before exiting the MFD_PROFILE, give those joins unique names and issue a JOIN CLEAR command that clears only those joins. Do not issue the JOIN CLEAR * command as that will clear any joins established prior to executing the MFD_PROFILE.

Creating a Lookup File and Setting a Global Variable Using an MFD_PROFILE

The following version of the EMPDATA Master File:

- Specifies an MFD_PROFILE named DDBAEMP.
- Defines a variable to be used as the TITLE attribute for the PIN field.
- Defines the fields TYPE_EMP and EMP_TYPE to classify employees as full-time or part-time based on the values in the JOBS lookup file.
- Has DBA restrictions. For user HR3, the VALUE clause does a lookup of values in the JOBS lookup file.

The edited EMPDATA Master File is

```
FILENAME=EMPDATA, SUFFIX=FOC, MFD_PROFILE=baseapp/DDBAEMP,$
VARIABLE NAME = Emptitle, USAGE=A30, DEFAULT=EMPID,$
SEGMENT=EMPDATA,SEGTYPE=S0, $
FIELDNAME=PIN , ALIAS=ID, USAGE=A9, INDEX=I, TITLE='&&Emptitle', $
FIELDNAME=LASTNAME, ALIAS=LN, FORMAT=A15, $
FIELDNAME=FIRSTNAME, ALIAS=FN, FORMAT=A10, $
FIELDNAME=MIDINITIAL, ALIAS=MI, FORMAT=A1, $
FIELDNAME=DIV, ALIAS=CDIV, FORMAT=A4, $
FIELDNAME=DEPT, ALIAS=CDEPT, FORMAT=A20, $
FIELDNAME=JOBCLASS, ALIAS=CJCLAS, FORMAT=A8, $
FIELDNAME=TITLE, ALIAS=CFUNC, FORMAT=A20, $
FIELDNAME=SALARY, ALIAS=CSAL, FORMAT=D12.2M, $
FIELDNAME=HIREDATE, ALIAS=HDAT, FORMAT=YMD, $
$
DEFINE AREA/A13=DECODE DIV (NE 'NORTH EASTERN' SE 'SOUTH EASTERN'
CE 'CENTRAL' WE 'WESTERN' CORP 'CORPORATE' ELSE 'INVALID AREA');$
```



```

DEFINE TYPE_EMP/I1 = DECODE JOBCLASS(JOBS ELSE 1);,$
DEFINE EMP_TYPE/A10 = IF TYPE_EMP EQ 1
    THEN 'FULL_TIME' ELSE 'PART_TIME';
END
DBA=USERD,$
USER=USER1,ACCESS=R,RESTRICT=FIELD,NAME=SALARY,$
USER=USER2,ACCESS=R,RESTRICT=VALUE,NAME=SYSTEM,
    VALUE=DEPT EQ SALES OR MARKETING,$
USER=HR1,ACCESS=R,RESTRICT=VALUE,NAME=SYSTEM,
    VALUE=SALARY FROM 20000 TO 35000,$
USER=HR2,ACCESS=R,RESTRICT=VALUE,NAME=EMPDATA,VALUE=SALARY GT 0,$
USER=HR3,ACCESS=R,RESTRICT=VALUE,NAME=SYSTEM,VALUE=JOBCLASS EQ (JOBS),$

```

The DDBAEMP procedure sets a value for the global variable &&Emptitle and creates the JOBS lookup file:

```
DYNAM ALLOC DD JOBS DA USER1.JOBS.FTM SHR REU
```

```

-RUN
-SET &&Emptitle = 'Employee ID';
TABLE FILE JOBLIST
PRINT JOBCLASS
WHERE JOBDESC CONTAINS '2ND' OR '3RD'
ON TABLE HOLD AS JOBS
END

```

The following request against the EMPDATA data source allocates the JOBS file and sets the user password to HR3. The EMP_TYPE field and the DBA VALUE restriction for user HR3 use the JOBS file created by the MFD_PROFILE as a lookup table:

```
DYNAM ALLOC DD JOBS DA USER1.JOBS.FTM SHR REU
```

```

-SET &PASS = 'HR3';
SET PASS = &PASS
-RUN
TABLE FILE EMPDATA
" Password used is &PASS "
" "
"USER1 -- Can't see Salary, reject request"
"USER2 -- Can see Sales and Marketing departments only"
"HR1 -- Can see salaries from 20 TO 35 K "
"HR2 -- Can see everyone "

```

```
"HR3  -- Can see Part Time only "
" "
PRINT PIN SALARY DEPT EMP_TYPE
ON TABLE HOLD FORMAT HTMLON TABLE SET PAGE NOPAGE
ON TABLE SET STYLE *
TYPE=REPORT, GRID=OFF, FONT=ARIAL,$
END
```

On the output, the column title for the PIN field is the value of the `&&Emptitle` variable set in the `MFD_PROFILE` procedure, and the `JOBS` file created by the profile was used in limiting the report output to Part Time employees, which are the only ones user `HR3` is allowed to see:

Password used is HR3

```
USER1 -- Can't see Salary, reject request
USER2 -- Can see Sales and Marketing departments only
HR1 -- Can see salaries from 20 TO 35 K
HR2 -- Can see everyone
HR3 -- Can see Part Time only
```

<u>Employee ID</u>	<u>SALARY DEPT</u>	<u>EMP TYPE</u>
000000090	\$33,000.00 PERSONNEL	Part Time
000000100	\$32,400.00 ACCOUNTING	Part Time
000000110	\$19,300.00 CUSTOMER SUPPORT	Part Time
000000180	\$25,400.00 ADMIN SERVICES	Part Time
000000240	\$33,300.00 PERSONNEL	Part Time
000000400	\$26,400.00 ACCOUNTING	Part Time

Creating a DBAFILE Using an MFD_PROFILE

The following version of the `EMPDATA` Master File specifies an `MFD_PROFILE` named `DDEMP2` and a `DBAFILE` named `DBAEMP2`. The `MFD_PROFILE` will create the `DBAFILE` by reading security attributes from a sequential file named `security.data`.

The Master File is:

```
FILENAME=EMPDATA, SUFFIX=FOC, MFD_PROFILE=DDEMP2,$
SEGMENT=EMPDATA, SEGTYPE=S0, $
```

```

FIELDNAME=PIN      , ALIAS=ID, USAGE=A9, INDEX=I,  TITLE='Employee Id', $
FIELDNAME=LASTNAME, ALIAS=LN,      FORMAT=A15,      $
FIELDNAME=FIRSTNAME, ALIAS=FN,     FORMAT=A10,     $
FIELDNAME=MIDINITIAL, ALIAS=MI,    FORMAT=A1,      $
FIELDNAME=DIV,       ALIAS=CDIV,   FORMAT=A4,      $
FIELDNAME=DEPT,      ALIAS=CDEPT,  FORMAT=A20,    $
FIELDNAME=JOBCLASS, ALIAS=CJCLAS,  FORMAT=A8,     $
FIELDNAME=TITLE,     ALIAS=CFUNC,  FORMAT=A20,    $
FIELDNAME=SALARY,    ALIAS=CSAL,   FORMAT=D12.2M, $
FIELDNAME=HIREDATE, ALIAS=HDAT,   FORMAT=YMD,    $
$
DEFINE AREA/A13=DECODE DIV (NE 'NORTH EASTERN' SE 'SOUTH EASTERN'
CE 'CENTRAL' WE 'WESTERN' CORP 'CORPORATE' ELSE 'INVALID AREA');$
END
DBA=USERD,DBAFILE=DBAEMP2,$

```

The file with the security attributes (security.data) follows. The security attributes are the USER, ACCESS, RESTRICT, NAME, and VALUE attributes:

```

USER1      R  NOPRINT      SALARY
USER2      R  VALUE        SYSTEM DEPT EQ SALES OR MARKETING
HR1        R  VALUE        SYSTEM SALARY FROM 20000 TO 35000
HR1        W  SEGMENT      EMPDATA
HR2        R  VALUE        EMPDATA SALARY GT 0

```

According to these attributes, a user with the password:

- USER1 cannot print the values in the SALARY field.
- USER2 can only see the SALES and MARKETING departments.
- HR1 can only see salaries from 20000 to 35000. HR1 can also write to the EMPDATA segment.
- HR2 can see everything in the EMPDATA segment.

The DDEMP2 profile procedure:

- Uses the Dialogue Manager command -WRITE to write records into the DBAEMP2 Master File. It first writes the FILE declaration, a SEGMENT declaration, a FIELD declaration, the END declaration that starts the DBA section of the Master File, and the DBA password (which must be the same as the DBA password in the EMPDATA Master File).

The rest of the DBA section will be created by reading each record from the

security.data file and writing a corresponding DBA record to the DBAEMP2 Master File.

- Uses the Master File name passed as argument &1 to write a FILE declaration for the EMPDATA Master File, which will then be followed by the DBA declarations specific to that Master File.
- Loops to read each record in the security.data file using the Dialogue Manager command -READFILE. It checks if there is a RESTRICT attribute and, if so, checks if it has a VALUE attribute. Depending on which attributes are present, it writes a record to the DBAEMP2 Master File.

The DDEMP2 profile procedure follows:

```
-* FILEDEF the input security.data file (Windows)
FILEDEF SECURITY DISK c:\ibi\apps\baseapp\security.data (LRECL 81
```

```
-* DYNAM the output DBAEMP2 Master File and the input file (z/OS)
DYNAM OUTFI DA USER1.DBAEMP2.MASTER SHR REU
DYNAM SECURITY DA USER1.SECURITY.DATA SHR REU
```

```
-RUN
-* Write out the first part of the DBAEMP2 Master File
-WRITE OUTFI FILE=DBAEMP2,SUFFIX=FIX,$
-WRITE OUTFI SEGNAME=ONE,SEGTYPE=S0
-WRITE OUTFI FIELD=ONE,,A1,A1,$
-WRITE OUTFI END
-WRITE OUTFI DBA=USERD,$
-* Write out a FILE declaration for the calling Master File, passed as
&1
-WRITE OUTFI FILE=&1,$
-* Initialize the variables to be read from the security.data file
-SET &USER=' ';
-SET &ACCESS=' ';
-SET &RESTRICT=' ';
-SET &NAME = ' ';
-SET &VALUE = ' ';
```

```
-* Establish the loop for each record of the security.data file
-SET &DONE = N ;
-REPEAT ENDLP WHILE &DONE EQ N ;
-* Read a record from security.data
-READFILE SECURITY
```

```

-* Check if the end of the security.data file was reached and,
-*   if so, branch out of the loop
-SET &DONE = IF &IORETURN EQ 1 THEN 'Y' ELSE 'N';
-IF &DONE EQ 'Y' GOTO ENDLP1;
-* If there is a RESTRICT attribute, go to the label -CHKSTR.
-IF &RESTRICT NE ' ' THEN GOTO CHKRSTR;
-* If there is no RESTRICT attribute,
-* write the USER and ACCESS attributes, and loop for the next record
-WRITE OUTFI USER=&USER , ACCESS=&ACCESS , $
-GOTO ENDLP

```

```

-CHKRSTR
-* If there is a RESTRICT attribute, check if it has a VALUE attribute
-* and, if so, go to the label -CHKVAL
-IF &VALUE NE ' ' THEN GOTO CHKVAL;
-* If there is no VALUE attribute,
-* write USER, ACCESS, RESTRICT, and NAME, and loop for next record
-WRITE OUTFI USER=&USER, ACCESS=&ACCESS, RESTRICT=&RESTRICT,
NAME=&NAME,$
-GOTO ENDLP

```

```

-CHKVAL
-* If there is a VALUE attribute, write out USER, ACCESS, RESTRICT,
-* NAME, and VALUE, and loop for next record
-WRITE OUTFI USER=&USER, ACCESS=&ACCESS,RESTRICT=&RESTRICT,NAME=&NAME,
VALUE = &VALUE , $
-ENDLP
-ENDLP1

```

When run, this procedure creates the following DBAFILE:

```

FILE=DBAEMP2,SUFFIX=FIX,$
SEGNAME=ONE,SEGTYPE=S0
  FIELD=ONE,,A1,A1,$
END
DBA=USERD,$
FILE=EMPDATA,$
USER=USER1,ACCESS=R,RESTRICT=NOPRINT,NAME=SALARY , $
USER=USER2, ACCESS=R, RESTRICT=VALUE, NAME=SYSTEM,
  VALUE=DEPT EQ SALES OR MARKETING , $
USER=HR1, ACCESS=R, RESTRICT=VALUE, NAME=SYSTEM,
  VALUE = SALARY FROM 20000 TO 35000,$
USER=HR1, ACCESS=W, RESTRICT=SEGMENT, NAME=EMPDATA , $

```

```
USER=HR2, ACCESS=R, RESTRICT=VALUE, NAME=EMPDATA,
VALUE = SALARY GT 0 , $
```

The following request prints the PIN, SALARY, TITLE, and DEPT fields from EMPDATA:

```
TABLE FILE EMPDATA
PRINT SALARY TITLE DEPT
BY PIN
WHERE PIN GE '000000010' AND PIN LE '000000200'
ON TABLE SET PAGE NOPAGE
ON TABLE HOLD FORMAT PDF
END
```

To run the request, you must first set a valid user password. The MFD_PROFILE procedure will be run first and will create the dbaemp2.mas DBAFILE.

Running the request by first issuing the SET PASS=USER1 command produces the following report in which the salaries display as zeros because of the RESTRICT=NO PRINT attribute for the SALARY field:

<u>Employee Id</u>	<u>SALARY</u>	<u>TITLE</u>	<u>DEPT</u>
000000010	\$.00	MARKETING EXECUTIVE	MARKETING
000000020	\$.00	INDUSTRIAL MARKETER	MARKETING
000000030	\$.00	SALES MANAGER	SALES
000000040	\$.00	MARKETING DIRECTOR	MARKETING
000000050	\$.00	EXECUTIVE MANAGER	SALES
000000060	\$.00	MARKETING DIRECTOR	MARKETING
000000070	\$.00	MANAGER	ACCOUNTING
000000080	\$.00	SENIOR SALES EXEC.	MARKETING
000000090	\$.00	EMPLOYEE COORDINATOR	PERSONNEL
000000100	\$.00	SUPERVISOR OF AP/AR	ACCOUNTING
000000110	\$.00	PRODUCT DISTRIBUTOR	CUSTOMER SUPPORT
000000120	\$.00	CORPORATE CONSULTANT	CONSULTING
000000130	\$.00	MANAGER	MARKETING
000000140	\$.00	MANAGER	CUSTOMER SUPPORT
000000150	\$.00	SENIOR CONSULTANT	CONSULTING
000000160	\$.00	MNGR OF CUST SUPPORT	CUSTOMER SUPPORT
000000170	\$.00	ADMINISTRATOR	ADMIN SERVICES
000000180	\$.00	ASST ADMINISTRATOR	ADMIN SERVICES
000000190	\$.00	SALES SPECIALIST	SALES
000000200	\$.00	VICE PRES	SALES

Running the request by first issuing the SET PASS=USER2 command produces the following report in which only the SALES and MARKETING departments display because of the VALUE restriction for the DEPT field:

<u>Employee Id</u>	<u>SALARY</u>	<u>TITLE</u>	<u>DEPT</u>
000000010	\$55,500.00	MARKETING EXECUTIVE	MARKETING
000000020	\$62,500.00	INDUSTRIAL MARKETER	MARKETING
000000030	\$70,000.00	SALES MANAGER	SALES
000000040	\$62,500.00	MARKETING DIRECTOR	MARKETING
000000050	\$54,100.00	EXECUTIVE MANAGER	SALES
000000060	\$55,500.00	MARKETING DIRECTOR	MARKETING
000000080	\$43,400.00	SENIOR SALES EXEC.	MARKETING
000000130	\$62,500.00	MANAGER	MARKETING
000000190	\$39,000.00	SALES SPECIALIST	SALES
000000200	\$115,000.00	VICE PRES	SALES

Running the request by first issuing the SET PASS=HR1 command produces the following report in which only the salaries between 20000 and 35000 display because of the VALUE restriction for the DEPT field:

<u>Employee Id</u>	<u>SALARY</u>	<u>TITLE</u>	<u>DEPT</u>
000000090	\$33,000.00	EMPLOYEE COORDINATOR	PERSONNEL
000000100	\$32,400.00	SUPERVISOR OF AP/AR	ACCOUNTING
000000170	\$30,800.00	ADMINISTRATOR	ADMIN SERVICES
000000180	\$25,400.00	ASST ADMINISTRATOR	ADMIN SERVICES

Creating a Dynamic DBA Rule in a Master File

The sequential data source named VALTEST.DATA contains a list of user names and their associated value restrictions:

```
SALLY          CURR_SAL LT 20000
JOHN           DEPARTMENT EQ PRODUCTION
TOM            CURR_SAL GE 20000
```

Before reading this file, you must FILEDEF or allocate it:

```
FILEDEF VALTEST DISK baseapp/valtest.data
```

Or, on z/OS:

```
DYNAM ALLOC DD VALTEST DA USER1.VALTEST.DATA SHR REU
```

The following Master File named EMPDBA is a view of the EMPLOYEE data source. It has a DBA section that uses the global variable &&UID for the USER attribute and the global variable &&VAL for the value test against the EMPINFO segment. It also identifies a Master File profile named DBAEMP3. This profile will obtain the user ID of the connected user and find the correct VALUE restriction by reading the VALTEST.DATA file. By setting the global variables to the correct values, it will insert the appropriate DBA rule into the Master File.

```

FILENAME=EMPLOYEE, SUFFIX=FOC, MFD_PROFILE=DBAEMP3,$
VARIABLE NAME=&&UID, USAGE=A8 , $
VARIABLE NAME=&&VAL, USAGE=A25, $

SEGNAME=EMPINFO,  SEGTYPE=S1
  FIELDNAME=EMP_ID,      ALIAS=EID,      FORMAT=A9,      $
  FIELDNAME=LAST_NAME,  ALIAS=LN,      FORMAT=A15,     $
  FIELDNAME=FIRST_NAME, ALIAS=FN,      FORMAT=A10,     $
  FIELDNAME=HIRE_DATE,  ALIAS=HDT,     FORMAT=I6YMD,   $
  FIELDNAME=DEPARTMENT, ALIAS=DPT,     FORMAT=A10,     $
  FIELDNAME=CURR_SAL,   ALIAS=CSAL,    FORMAT=D12.2M,  $
  FIELDNAME=CURR_JOBCODE, ALIAS=CJC,    FORMAT=A3,      $
  FIELDNAME=ED_HRS,     ALIAS=OJT,     FORMAT=F6.2,    $
END
DBA=DBAUSER1,$
USER=&&UID,ACCESS=R,RESTRICT=VALUE,NAME=EMPINFO,VALUE=&&VAL,$

```

The following is the MFD_PROFILE procedure:

```

SET MESSAGE = OFF
-SET &VALUETEST = 'NOTFOUND';
-* Find the user ID of the connected user
-SET &&UID = GETUSER('A20');
-SET &&UID = TRUNCATE(&&UID);
-* Create a HOLD file with the value test for the connected user
TABLE FILE VALTEST
PRINT VALUETEST
WHERE USERNAME EQ '&&UID'
ON TABLE HOLD AS USERVAL FORMAT ALPHA
END
-RUN
-READ USERVAL &VALUETEST.A30
-* If the user name was not in the file, type a message and exit
-IF &VALUETEST NE 'NOTFOUND' GOTO SETVALUE;
-TYPE USER WASN'T THERE
-EXIT
-SETVALUE
-* Set the global variable for the value test to the correct test
-SET &&VAL = ''|&VALUETEST||';
-* Set the USER parameter to the user ID of the connected user
SET USER = &&UID

```

The following request displays a report against the EMPDBA view of the EMPLOYEE data source:

```

USE
EMPLOYEE AS EMPDBA
END
-RUN
TABLE FILE EMPDBA
PRINT LN FN CURR_SAL
BY DEPARTMENT
ON TABLE SET PAGE NOPAGE
END

```

Running the request when SALLY is the connected user produces a report of employees whose salaries are less than \$20,000:

DEPARTMENT	LAST_NAME	FIRST_NAME	CURR_SAL
MIS	SMITH	MARY	\$13,200.00
	JONES	DIANE	\$18,480.00
	MCCOY	JOHN	\$18,480.00
PRODUCTION	GREENSPAN	MARY	\$9,000.00
	STEVENS	ALFRED	\$11,000.00
	SMITH	RICHARD	\$9,500.00
	MCKNIGHT	ROGER	\$16,100.00

Running the request when TOM is the connected user produces a report of employees whose salaries are greater than or equal to \$20,000:

DEPARTMENT	LAST_NAME	FIRST_NAME	CURR_SAL
MIS	BLACKWOOD	ROSEMARIE	\$21,780.00
	CROSS	BARBARA	\$27,062.00
PRODUCTION	BANNING	JOHN	\$29,700.00
	IRVING	JOAN	\$26,862.00
	ROMANS	ANTHONY	\$21,120.00

Running the request when JOHN is the connected user produces a report that includes only the PRODUCTION department:

DEPARTMENT	LAST_NAME	FIRST_NAME	CURR_SAL
PRODUCTION	STEVENS	ALFRED	\$11,000.00
	SMITH	RICHARD	\$9,500.00
	BANNING	JOHN	\$29,700.00
	IRVING	JOAN	\$26,862.00

ROMANS	ANTHONY	\$21,120.00
MCKNIGHT	ROGER	\$16,100.00

Describing a Group of Fields

Certain fields in a data source may have a one-to-one correspondence. The different groups formed can be related to one another. For some types of data sources you can define a subset, a logical view of a group. You can identify these groups and the relationships between them by using attributes in the Master and Access File, as well as related facilities, such as the JOIN command.

This section describes the relationships of fields and how to implement them using Master File attributes. If your type of data source also requires an Access File, see the appropriate data adapter documentation for supplementary information about defining groups and group relations in the Access File.

Defining a Single Group of Fields

Certain fields in a data source may have a one-to-one correspondence. For each value of a field, the other fields may have exactly one corresponding value. For example, consider the EMPLOYEE data source:

- Each employee has one ID number which is unique to that employee.
- For each ID number there is one first and last name, one date hired, one department, and one current salary.

In the data source, one field represents each of these employee characteristics. The entire group of fields represents the employee. In Master File terms, this group is called a *segment*.

Understanding a Segment

A segment is a group of fields that have a one-to-one correspondence with each other and usually describe a group of related characteristics. In a relational data source, a segment is equivalent to a table. Segments are the building blocks of larger data structures. You can

relate different segments to each other, and describe the new structures, as discussed in [Relating Multiple Groups of Fields](#).

The following diagram illustrates the concept of a segment.

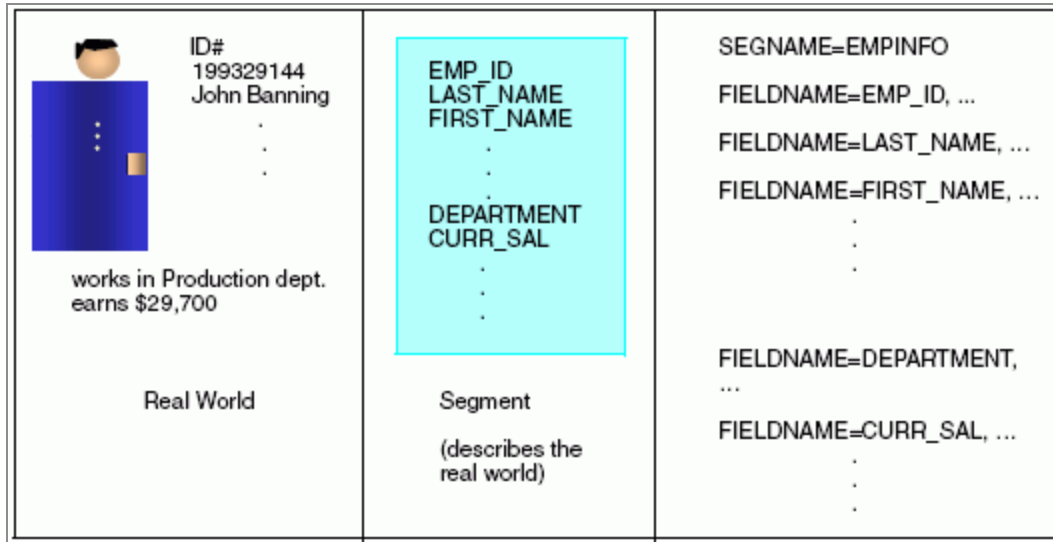

Understanding a Segment Instance

While a segment is an abstract description of data, the instances that correspond to it are the actual data. Each instance is an occurrence of segment values found in the data source. For a relational data source, an instance is equivalent to a row in a table. In a single segment data source, a segment instance is the same as a record.

The relationship of a segment to its instances is illustrated in the following diagram.

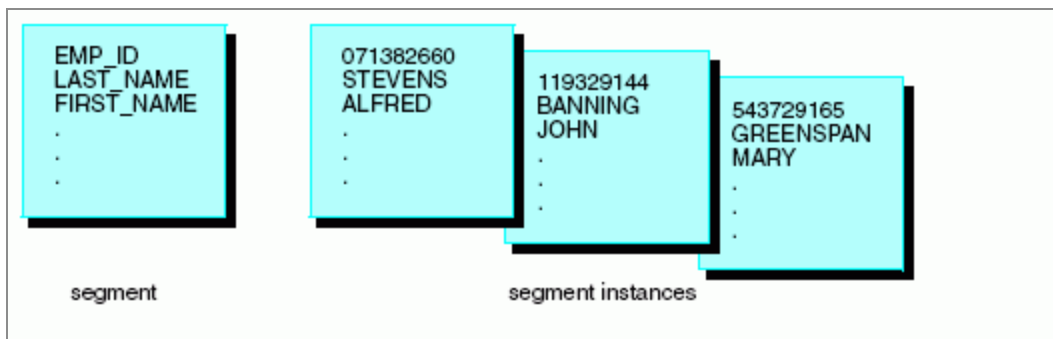

Understanding a Segment Chain

The instances of a segment that are descended from a single parent instance are collectively known as a segment chain. In the special case of a root segment, which has no parent, all of the root instances form a chain. The parent-child relationship is discussed in [Logical Dependence: The Parent-Child Relationship](#).

The following diagram illustrates the concept of a segment chain.

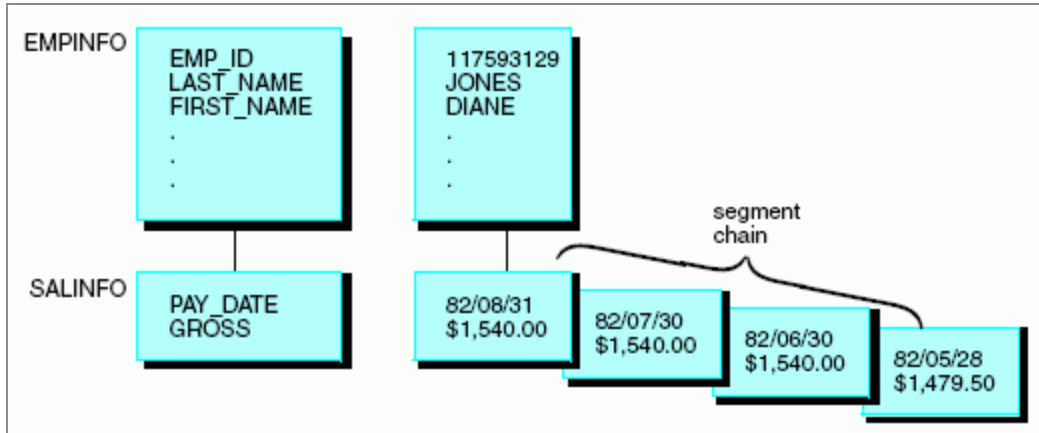

Describe a segment using the SEGNAME and SEGTYPE attributes in the Master File. The SEGNAME attribute is described in [Identifying a Segment: SEGNAME](#).

Identifying a Key Field

Most segments also have key fields, which are one or more fields that uniquely identify each segment instance. In the EMPLOYEE data source, the ID number is the key because each employee has one ID number, and no other employee has the same number. The ID number is represented in the data source by the EMP_ID field.

If your data source uses an Access File, you may need to specify which fields serve as keys by identifying them in the Access File. If the data source also happens to be a relational data source, the fields constituting the primary key in the Master File should be the first fields described for that segment, meaning that the field declarations should come before any others in that segment.

For FOCUS data sources, identify key fields and their sorting order using the SEGTYPE attribute in the Master File, as shown in [Describing a FOCUS Data Source](#). Position the key fields as the first fields in the segment.

Identifying a Segment: SEGNAME

The SEGNAME attribute identifies the segment. It is the first attribute you specify in a segment declaration. Its alias is SEGMENT.

For a FOCUS data source, the segment name may consist of up to eight characters. Segment names for an XFOCUS data source may have up to 64 characters. You can use segment names of up to 64 characters for non-FOCUS data sources, if supported by the DBMS. To make the Master File self-documenting, set SEGNAME to something meaningful to the user or the native file manager. For example, if you are describing a DB2 table, assign the table name (or an abbreviation) to SEGNAME.

In a Master File, each segment name must be unique. The only exception to this rule is in a FOCUS or XFOCUS data source, where cross-referenced segments in Master File-defined joins can have the same name as other cross-referenced segments in Master File-defined joins. If their names are identical, you can still refer to them uniquely by using the CRSEGNAME attribute. See [Defining a Join in a Master File](#).

In a FOCUS or XFOCUS data source, you cannot change the value of SEGNAME after data has been entered into the data source. For all other types of data sources, you can change SEGNAME as long as you also change all references to it. For example, any references in the Master and Access File.

If your data source uses an Access File as well as a Master File, you must specify the same segment name in both.

Identify a Segment

```
{SEGNAME | SEGMENT} = segment_name
```

where:

segment_name

Is the name that identifies this segment. For a FOCUS data source, it can be a maximum of eight characters long. Segment names for an XFOCUS data source can consist of up to 64 characters. You can use segment names of up to 64 characters for non-FOCUS data sources, if supported by the DBMS.

The first character must be a letter, and the remaining characters can be any combination of letters, numbers, and underscores (_). It is not recommended to use other characters, because they may cause problems in some operating environments or when resolving expressions.

Identifying a Segment

If a segment corresponds to a relational table named TICKETS, and you want to give the segment the same name, use the SEGNAME attribute in the following way:

```
SEGNAME = TICKETS
```

Identifying a Logical View: Redefining a Segment

The segments that you define usually correspond to underlying groups in your data source. For example, a segment could be a table in a relational data source.

However, you are not limited to using the segment as it was originally defined in the native data source. You can define a logical view which includes only a subset of the fields in a segment fields (similar to a relational view), or define the unwanted fields as one or more filler fields. This technique can be helpful if, for example, you only want to make some of the fields in the segment available to an application or its users.

Use these methods with the following types of data sources:

- **Relational data sources.** Omit unwanted fields from the segment description in the Master File.
- **Non-relational data sources.** Define unwanted fields as one or more filler fields.

To restrict access explicitly at the file, segment, or field level based on user ID, field values, and other characteristics, use the DBA facility as described in [Providing Data Source Security: DBA](#).

Omitting a Field: Creating a Segment Subset

Define a logical view for a relational data source by omitting the unwanted fields from the segment description in the Master File. Consider the following Master File for an Oracle table named EMPFACTS:

```
FILENAME = EMPFACTS, SUFFIX = SQLORA , $
SEGNAME = EMPFACTS, SEGTYPE = S0 , $
FIELDNAME= EMP_NUMBER, ALIAS= ENUM, USAGE= A9, ACTUAL= A9 , $
FIELDNAME= LAST_NAME, ALIAS= LNAME, USAGE= A15, ACTUAL= A15 , $
FIELDNAME= FIRST_NAME, ALIAS= FNAME, USAGE= A10, ACTUAL= A10 , $
FIELDNAME= HIRE_DATE, ALIAS= HDT, USAGE= I6YMD, ACTUAL= DATE , $
FIELDNAME= DEPARTMENT, ALIAS= DPT, USAGE= A10, ACTUAL= A10 , $
FIELDNAME= SALARY, ALIAS= SAL, USAGE= D12.2M, ACTUAL= D8 , $
FIELDNAME= JOBCODE, ALIAS= JCD, USAGE= A3, ACTUAL= A3 , $
FIELDNAME= OFFICE_NUM, ALIAS= OFN, USAGE= I8, ACTUAL= I4 , $
```

If you develop an application that refers to only the employee ID and name fields, and you want this to be reflected in the application view of the segment, you can code an alternative Master File that names only the desired fields:

```
FILENAME = EMPFACTS, SUFFIX = SQLORA , $
SEGNAME = EMPFACTS, SEGTYPE = S0 , $
FIELDNAME= EMP_NUMBER, ALIAS= ENUM, USAGE= A9, ACTUAL= A9 , $
FIELDNAME= LAST_NAME, ALIAS= LNAME, USAGE= A15, ACTUAL= A15 , $
FIELDNAME= FIRST_NAME, ALIAS= FNAME, USAGE= A10, ACTUAL= A10 , $
```

Redefining a Field: Creating a Filler Field

Define a logical view for certain data sources, such as a sequential or FOCUS data source, by defining the fields excluded from the view as one or more filler fields. Define the field format as alphanumeric, its length as the number of bytes making up the underlying fields, and its name and alias as blank. Field declarations and length are discussed in detail in [Describing an Individual Field](#).

Consider the EMPINFO segment of the EMPLOYEE data source:

```
SEGNAME = EMPINFO, SEGTYPE = S1 , $
FIELDNAME = EMP_ID, ALIAS = EID, USAGE = A9 , $
FIELDNAME = LAST_NAME, ALIAS = LN, USAGE = A15 , $
```



```

FIELDNAME = FIRST_NAME,    ALIAS = FN,    USAGE = A10    ,$
FIELDNAME = HIRE_DATE,     ALIAS = HDT,   USAGE = I6YMD  ,$
FIELDNAME = DEPARTMENT,   ALIAS = DPT,   USAGE = A10    ,$
FIELDNAME = CURR_SAL,      ALIAS = CSAL,  USAGE = D12.2M ,$
FIELDNAME = CURR_JOBCODE,  ALIAS = CJC,   USAGE = A3     ,$
FIELDNAME = ED_HRS,        ALIAS = OJT,   USAGE = F6.2   ,$

```

If you develop an application that refers to only the employee ID and name fields, and you want this to be reflected in the application view of the segment, you can code an alternative Master File that explicitly names only the desired fields:

```

SEGNAME = EMPINFO, SEGTYPE = S1 ,$
FIELDNAME = EMP_ID,    ALIAS = EID,  USAGE = A9    ,$
FIELDNAME = LAST_NAME, ALIAS = LN,   USAGE = A15   ,$
FIELDNAME = FIRST_NAME, ALIAS = FN,   USAGE = A10   ,$
FIELDNAME = ,          ALIAS = ,      USAGE = A29   ,$

```

The filler field is defined as an alphanumeric field of 29 bytes, which is the combined internal length of the fields it replaces: HIRE_DATE (4 bytes), DEPARTMENT (10 bytes), CURR_SAL (8 bytes), CURR_JOBCODE (3 bytes), and ED_HRS (4 bytes).

Relating Multiple Groups of Fields

After you have described a segment, you can relate segments to each other to build more sophisticated data structures. You can:

- **Describe physical relationships.** If groups of fields are already physically related in your data source, you can describe the relationship.
- **Describe logical relationships.** Describe a logical relationship between any two segments that have at least one field in common by joining them. The underlying data structures remain physically separate, but they are treated as if they were part of a single structure. The new structure can include segments from the same or different types of data sources.

If you are creating a new FOCUS data source, you can implement segment relationships in several ways, depending upon your design goals, as described in [Describing a FOCUS Data Source](#).

To describe a data structure containing several segments, whether it is a multisegment data source or several data sources that have been joined together, you should be aware of the following:

- Logical dependence between related segments.
- Logical independence between unrelated segments.

Facilities for Specifying a Segment Relationship

There are several facilities for specifying relationships between segments. The use of a Master and Access File to specify a relationship is documented in this chapter. The JOIN command, which joins segments into a structure from which you can report, is described in the *FOCUS® Creating Reports* manual.

A related facility, the MATCH FILE command, enables many types of relationships by first describing a relationship as a series of extraction and merging conditions, then merging the related data into a new single segment data source. The result is not a joined structure, but an entirely new data source that can be further processed. The original data sources remain unchanged. The MATCH FILE command is documented in the *FOCUS® Creating Reports* manual.

Identifying a Parent Segment: PARENT

The PARENT attribute identifies a parent segment. Specify the PARENT attribute in the segment declaration of the Master File. Because a root segment has no parent, you do not specify the PARENT segment when declaring a root.

A parent segment must be declared in the Master File before any of its child segments.

If the parent-child relationship is permanently implemented within the structure of the data source, such as within a FOCUS data source, then you cannot change the PARENT attribute without changing the underlying structure of the data source. However, if the parent-child relationship is temporary, as it is when you join several relational tables in the Master File, then you can change the PARENT attribute.

Identify the Parent Segment

```
PARENT = segment_name
```

where:

segment_name

If no PARENT attribute is specified in a Master File, then by default, each segment takes the preceding segment in the Master File as its parent. If a PARENT attribute is specified, then all segments that follow will take that segment as their parent, unless explicitly specified.

It is recommended that you use the PARENT attribute for unique segments with a SEGTYPE of U.

Identifying a Parent Segment

In the EMPLOYEE data source, SALINFO is the parent of DEDUCT, so the segment declaration for DEDUCT includes the following attribute:

```
PARENT = SALINFO
```

Identifying the Type of Relationship: SEGTYPE

The SEGTYPE attribute specifies the type of relationship that a segment has to its parent. SEGTYPE is part of the segment declaration and is used differently in various types of data sources. For sequential, VSAM, and ISAM data sources, see [Describing a Sequential, VSAM, or ISAM Data Source](#). For FOCUS data sources, see [Describing a FOCUS Data Source](#). For other types of data sources, see the appropriate data adapter documentation for details.

Understanding the Efficiency of the Minimum Referenced Subtree

In any database structure consisting of more than a single table or segment, FOCUS handles retrieval by only accessing data from the minimum referenced subtree, which is a subset of the full database structure. A minimum referenced subtree consists of only those segments containing referenced fields, and any intervening segments needed to make a complete structure.

Consider the following database structure consisting of three segments, A, B, and C, with A being the parent of B, and B the parent of C. Segment A is also known as the root segment. This structure may be three different joined tables, or a single, multisegment structure.

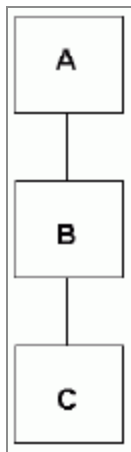

If a database request references fields contained only in segment A, then only data in segment A is retrieved. Likewise, if fields from segments A and B are requested, only segments A and B are retrieved. No additional retrieval costs are incurred, as would occur if all three segments were retrieved for each request.

For joined structures, there is an implicit reference to the root segment, which is always retrieved in a database request. If a request involving a joined structure references fields from segment B only, both segments A and B are retrieved since the root segment (A) is implied to link segment B. Additionally, if fields from segment C only are referenced, all three segments are retrieved since segments A and B are implied to link segment C. The retrieval costs are higher when intervening segments are retrieved for a request.

For multisegment structures, which are defined in the same Master File, there is no implied reference to the root segment. If a request involving this type of structure references fields from one segment only, such as segment C, then one segment only, segment C, is retrieved. However, if fields from segments A and C are referenced, then all three segments

are retrieved since segment B is an intervening segment required to make a complete structure. When all possible database relations are described in a single Master File, you can eliminate the costs associated with retrieving non-referenced segments.

Logical Dependence: The Parent-Child Relationship

Logical dependence between segments is expressed in terms of the parent-child relationship. A child segment is dependent upon its parent segment. An instance of the child segment can exist only if a related instance of the parent segment exists. The parent segment has logical precedence in the relationship, and is retrieved first when the data source is accessed.

Note that if the parent-child relationship is logical and not physical, as in the case of a join, it is possible to have a child instance without a related parent instance. In this case, the child instance is not accessible through the join, although it is still accessible independently.

If a join relates the parent-child segments, the parent is known as the host segment, and the child is known as the cross-referenced segment. The fields on which the join is based (that is, the matching fields in the host and cross-referenced segments) are known respectively as the host and cross-referenced fields.

A Simple Parent-Child Relationship

In the EMPLOYEE data source, the EMPINFO and SALINFO segments are related. EMPINFO identifies an employee by ID number, while SALINFO contains the pay history of the employee. EMPINFO is the parent segment, and SALINFO is a child segment dependent upon it. It is possible to have in this relationship an employee identified by ID and name for whom no salary information has been entered (that is, the parent instance without the child instance). However, it is meaningless to have salary information for an employee if one does not know who the employee is (that is, a child instance without the parent instance).

The following diagram illustrates the concept of a parent-child relationship.

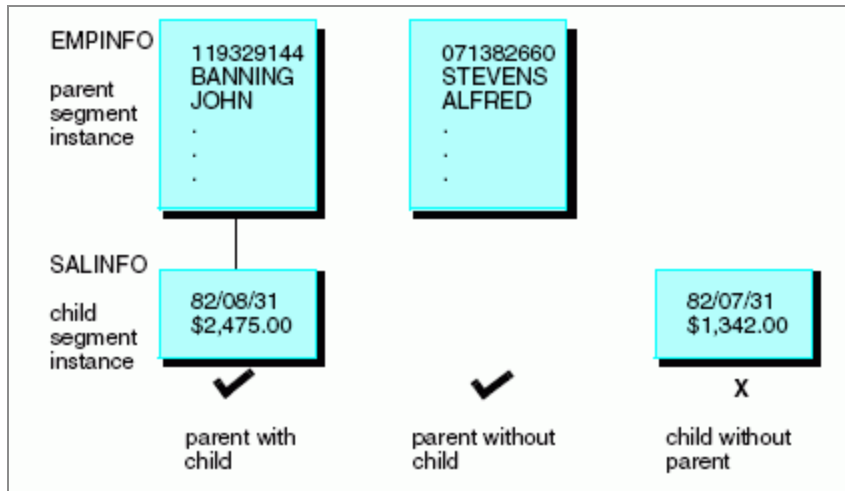

A Parent-Child Relationship With Multiple Segments

The same general parent-child relationships hold for data structures containing more than two segments. Consider the following diagram of a portion of the EMPLOYEE data source, containing the EMPINFO, SALINFO, and DEDUCT segments. DEDUCT contains payroll deduction information for each paycheck.

The following diagram illustrates the concept of a parent-child relationship with multiple segments.

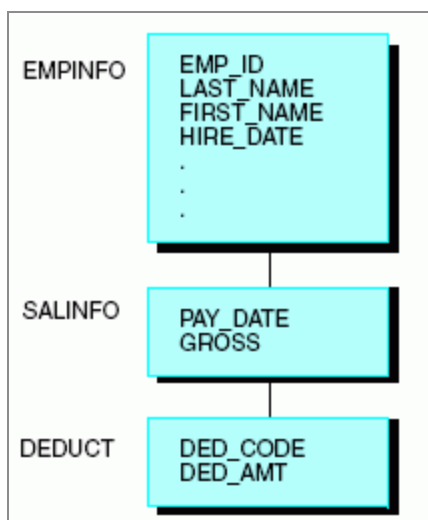

EMPINFO is related to SALINFO, and in this relationship EMPINFO is the parent segment and SALINFO is the child segment. SALINFO is also related to DEDUCT. In this second relationship, SALINFO is the parent segment and DEDUCT is the child segment. Just as SALINFO is dependent upon EMPINFO, DEDUCT is dependent upon SALINFO.

Understanding a Root Segment

The segment that has logical precedence over the entire data structure, the parent of the entire structure, is called the *root* segment. This is because a data structure can branch like a tree, and the root segment, like the root of a tree, is the source of the structure.

In the following diagram, EMPINFO is the root. It has no parent, and all other segments in the structure are its children, directly (SALINFO) or indirectly (DEDUCT).

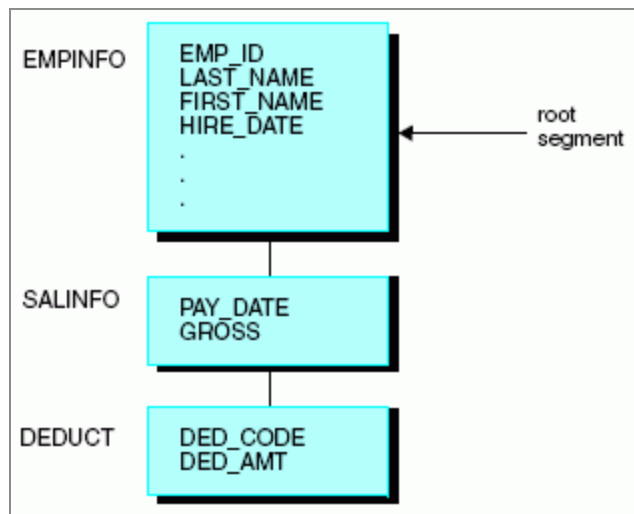

Understanding a Descendant Segment

Direct and indirect children of a segment are collectively known as its descendant segments. SALINFO and DEDUCT are descendants of EMPINFO. DEDUCT is also a descendant of SALINFO. A descendant segment with no children is called a *leaf* segment, because the branching of the data structure tree ends with the leaf. DEDUCT is a leaf.

The following diagram illustrates the concept of a descendant segment.

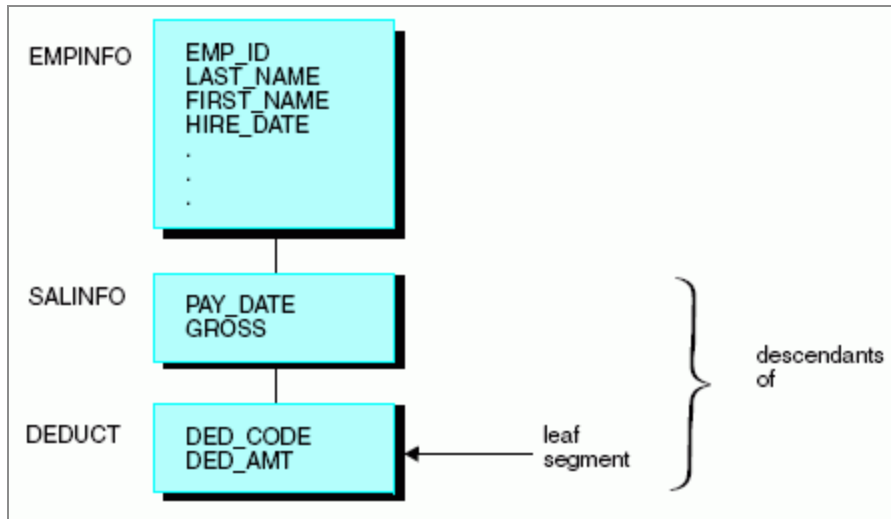

Understanding an Ancestral Segment

Direct and indirect parents of a segment are its ancestral segments. In the following diagram, SALINFO and EMPINFO are ancestors of DEDUCT.

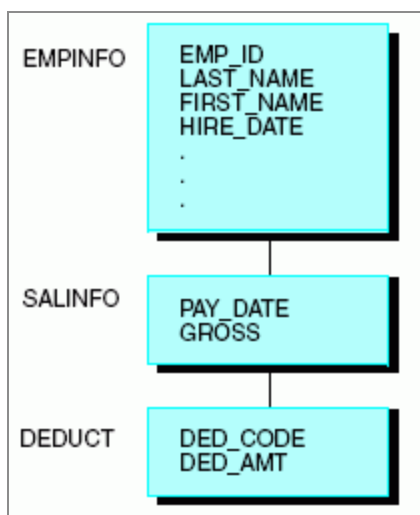

Logical Independence: Multiple Paths

A group of segments that are related to each other as a sequence of parent-child relationships, beginning with the root segment and continuing down to a leaf, is called a

path. Because the path is a sequence of parent-child relationships, each segment is logically dependent upon all of the segments higher in the path.

Understanding a Single Path

In the following view of the EMPLOYEE data source, EMPINFO, SALINFO, and DEDUCT form a path. An instance of DEDUCT (paycheck deductions) can exist only if a related instance of SALINFO (the paycheck) exists, and the instance of SALINFO can exist only if a related instance of EMPINFO (the employee) exists.

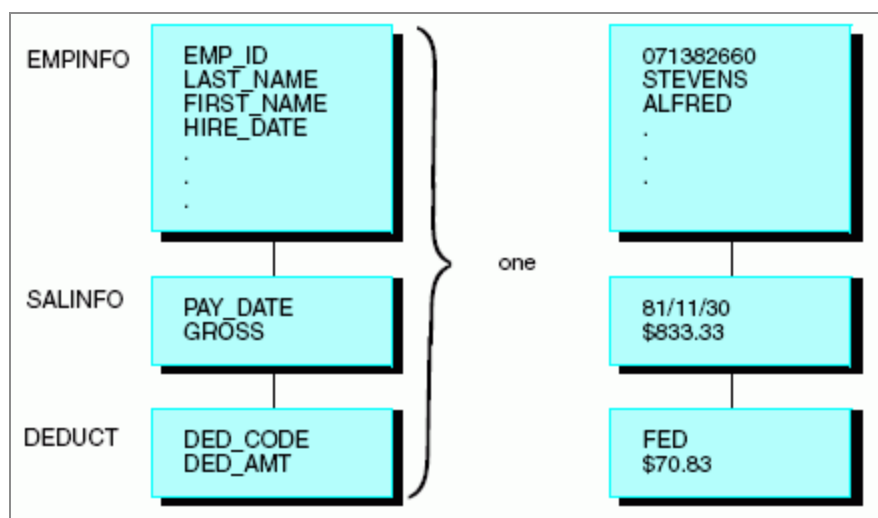

Understanding Multiple Paths

Consider the full EMPLOYEE structure, which includes the EMPLOYEE data source and the JOBFILE and EDUCFILE data sources that have been joined to it.

This is a multipath data structure. There are several paths, each beginning with the root segment and ending with a leaf. Every leaf segment is the end of a separate path. The following diagram illustrates the concept of a multipath data structure.

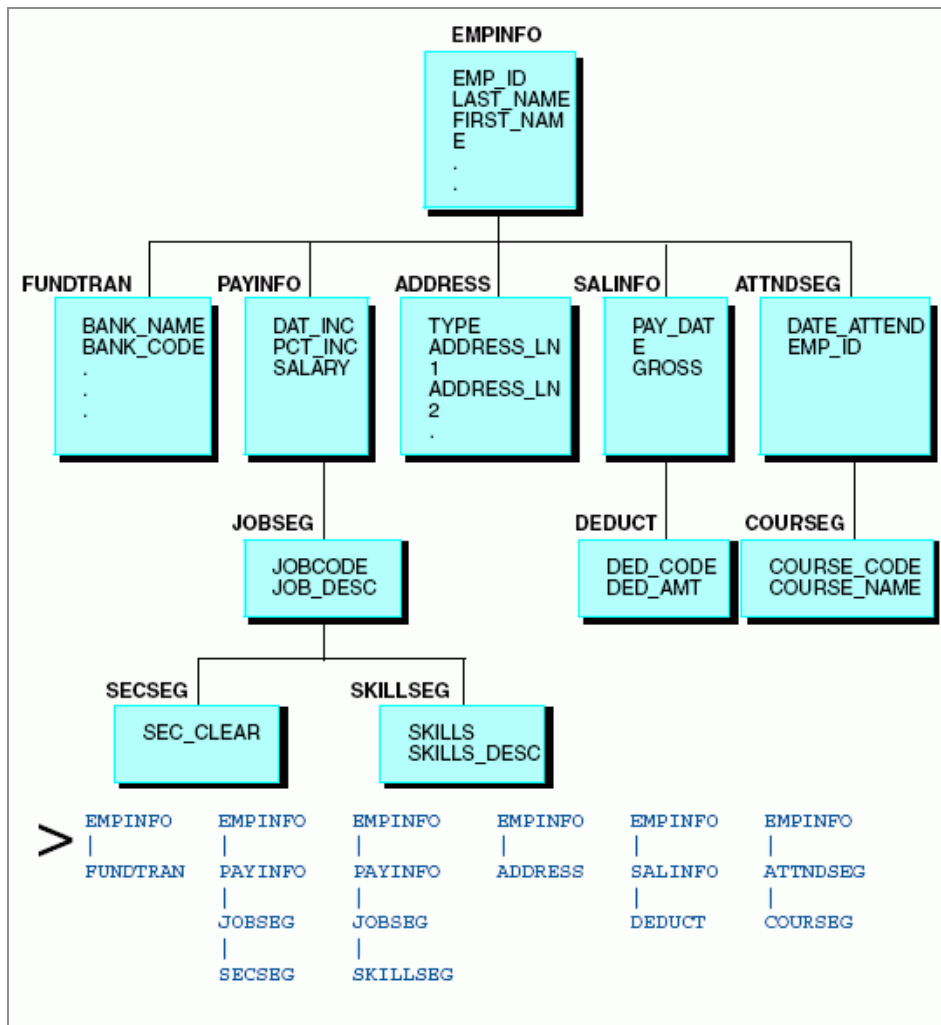

Understanding Logical Independence

The EMPLOYEE data structure has six paths. The paths begin with the EMPINFO segment (the root), and end with:

- The FUNDRAN segment.
- The SECSEG segment.
- The SKILLSEG segment.
- The ADDRESS segment.
- The DEDUCT segment.

- The COURSEG segment.

Each path is logically independent of the others. For example, an instance of DEDUCT is dependent upon its ancestor segment instances SALINFO and EMPINFO, but the ADDRESS segment lies in a different path, so DEDUCT is independent of ADDRESS.

This is because employee deductions are identified by the paycheck from which they came, so deduction information can be entered into the data source only if the paycheck from which the deduction was made is entered first. However, deductions are not identified by the employee address. An employee paycheck deduction can be entered without the address being known, and conversely, the employee address can be entered before any paychecks and deductions have been entered into the data source.

Cardinal Relationships Between Segments

The following types of cardinal relationships between groups of data are supported:

- One-to-one (1:1).
- One-to-many (1:M).
- Many-to-many (M:M).

You can define these relationships between:

- Instances of different segments.
- Instances of the same segment. That is, a recursive or bill-of-materials relationship.
- Segments from the same type of data source.
- Segments from different types of data sources. For example, you can define the relationship between an Oracle table and a FOCUS data source. Note that you can join different types of data sources only by using the JOIN command, not by defining the join in the Master File or Access File.
- If you are using a network data source, you can also rotate the data source after you have defined it, creating an alternate view that reverses some of the data relationships and enables you to access the segments in a different order.

One-to-One Relationship

Fields in a segment have a one-to-one relationship with each other. Segments can also exhibit a one-to-one relationship. Each instance of a parent segment can be related to one instance of a child segment, as shown in the following diagram. Because the relationship is one-to-one, the parent instance is never related to more than one instance of the child. However, not every parent instance must have a matching child instance.

The child in a one-to-one relationship is referred to as a unique segment, because there can never be more than a single child instance. The following diagram illustrates the concept of a one-to-one relationship.

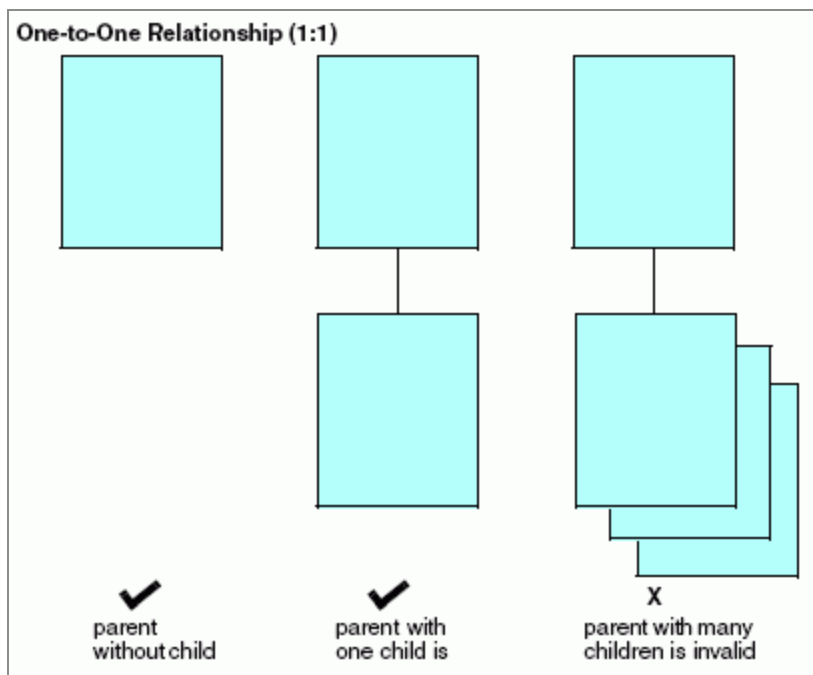

Understanding a One-to-One Relationship

In the EMPLOYEE data source, each EMPINFO segment instance describes one employee ID number, name, current salary, and other related information. Some employees have joined the Direct Deposit program, which deposits their paycheck directly into their bank accounts each week. For these employees, the data source also contains the name of their bank and their account number.

Because only one set of bank information is required for each employee (since each employee paycheck is deposited into only one account), there is a one-to-one relationship

between employee ID fields and bank information fields. Because there is limited participation in the Direct Deposit program, only some employees have bank information. Most of the employees do not need the bank fields.

The data source was designed with storage efficiency in mind, and so the bank fields have been put into a separate segment called FUNDTRAN. Space is only used for the banking information, creating an instance of FUNDTRAN, if it is needed. However, if banking fields are used in the parent segment (EMPINFO), the EMPINFO segment for each employee reserves space for the banking fields, even though those fields are empty in most cases. This concept is illustrated in the following diagram.

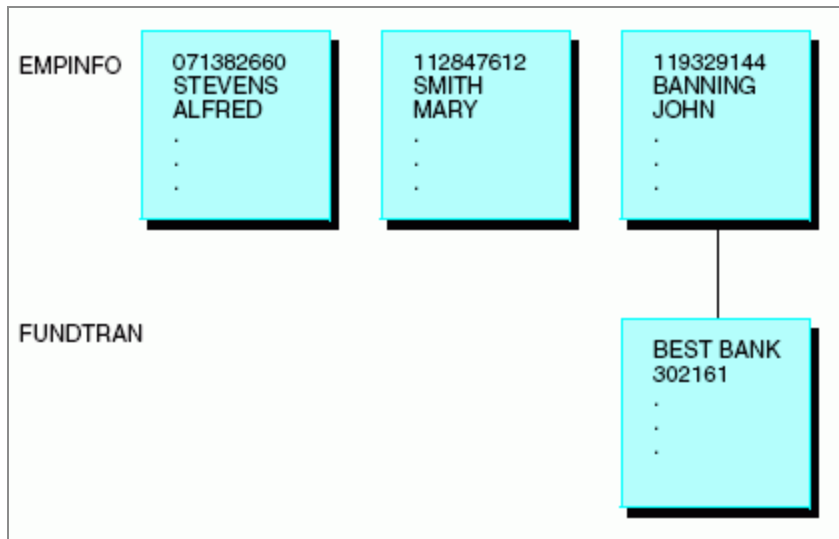

Where to Use a One-to-One Relationship

When you retrieve data, you can specify a segment as unique in order to enforce a one-to-one relationship.

When you retrieve data from a segment described as unique, the request treats the segment as an extension of its parent. If the unique segment has multiple instances, the request retrieves only one. If the unique segment has no instances, the request substitutes default values for the missing segment fields. Zero (0) is substituted for numeric fields, blank () is substituted for alphanumeric fields, and the missing value is substituted for fields that have the MISSING attribute specified. The MISSING attribute is described in [Describing an Individual Field](#).

Implementing a One-to-One Relationship in a Relational Data Source

Describe this relationship by joining the tables in the Master File and specifying a SEGTYPE of U for the child table. For more information on joining the tables in a Master File, see the appropriate data adapter documentation. Alternatively, you can join the tables by issuing the JOIN command without the ALL (or MULTIPLE) option (or with the UNIQUE option) and turning off the SQL Optimization facility with the SET OPTIMIZATION command.

Implementing a One-to-One Relationship in a Sequential Data Source

Specify this relationship between two records by issuing the JOIN command without the ALL (or MULTIPLE) option (or with the UNIQUE option).

Implementing a One-to-One Relationship in a FOCUS Data Source

Describe this relationship by specifying a SEGTYPE of U for the child segment. Alternately, you can join segments by issuing the JOIN command without the ALL (or MULTIPLE) option (or with the UNIQUE option), or by specifying a unique join in the Master File using a SEGTYPE of KU (for a static join) or DKU (for a dynamic join). All of these SEGTYPE values are described in [Describing a FOCUS Data Source](#).

You can also describe a one-to-one segment relationship as a one-to-many relationship in the Master File or by using the JOIN command. This technique gives you greater flexibility, but does not enforce the one-to-one relationship when reporting or entering data and does not use resources as efficiently.

One-to-Many Relationship

The most common relationship between two segments is the one-to-many relationship. Each instance of a parent segment can be related to one or more instances of a child segment. However, not every parent instance needs to have matching child instances.

The following diagram illustrates the concept of a one-to-many relationship.

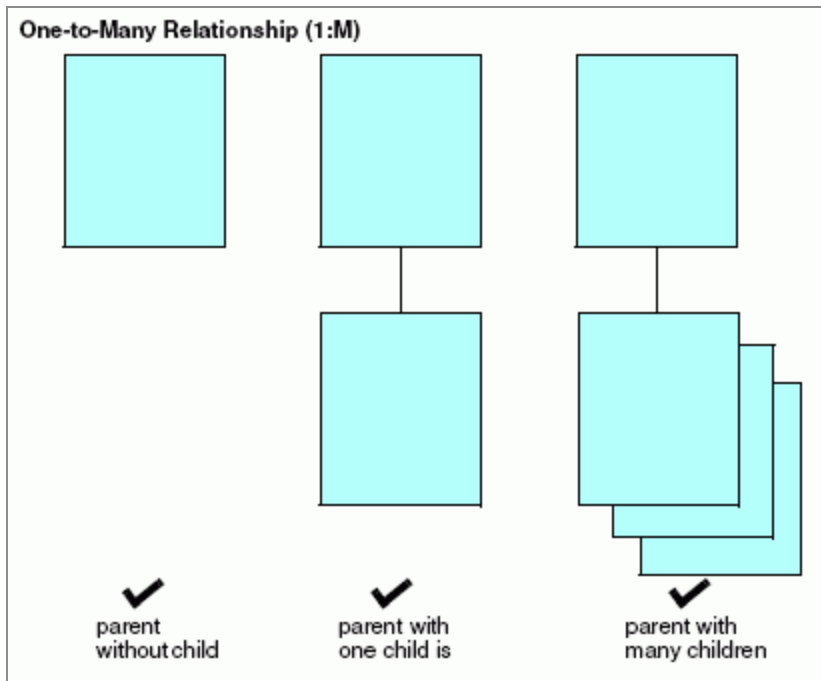

Understanding a One-to-Many Relationship

In the EMPLOYEE data source, each EMPINFO segment instance describes an employee ID number, name, current salary, and other related information. Each SALINFO segment contains an employee gross salary for each month. Most employees work for many months, so the relationship between EMPINFO and SALINFO is one-to-many.

The following diagram further illustrates the concept of a one-to-many relationship.

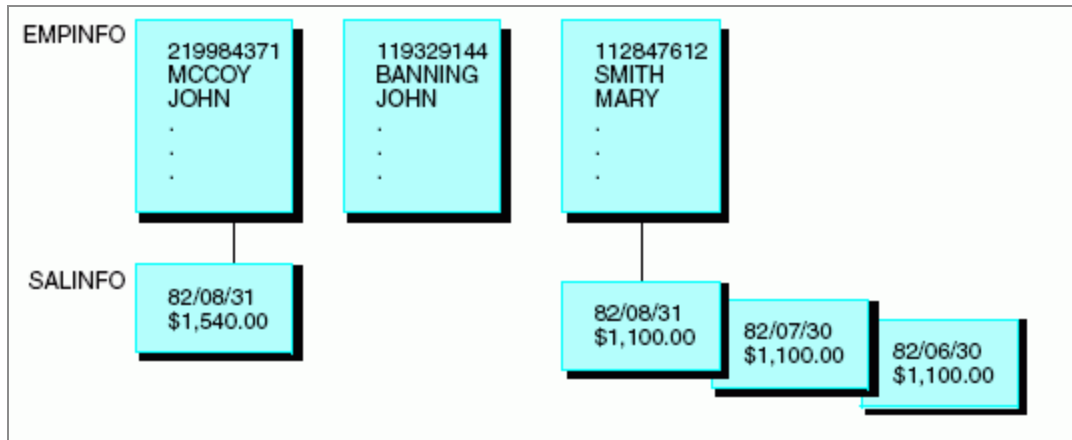

Implementing a One-to-Many Relationship in a Relational Data Source

Describe this relationship by joining the tables in the Master File and specifying a SEGTYPE of S0 for the child table. For more information on joining the tables in a Master File, see the appropriate data adapter documentation. Alternately, you can join the tables by issuing the JOIN command with the ALL or MULTIPLE option.

Implementing a One-to-Many Relationship in a VSAM or Sequential Data Source

You can describe a one-to-many relationship between a record and a group of multiply occurring fields within the record.

- The OCCURS attribute specifies how many times the field (or fields) occur.
- The POSITION attribute specifies where in the record the field (or fields) occur if they are not at the end of the record.
- The ORDER field determines the sequence number of an occurrence of a field.
- The PARENT attribute indicates the relationship between the singly and multiply occurring fields.

The OCCURS and POSITION attributes and the ORDER field are all described in [Describing a Sequential, VSAM, or ISAM Data Source](#).

Describe a one-to-many relationship between different records by using a RECTYPE field to indicate the type of each record, and the PARENT attribute to indicate the relationship between the different records. RECTYPE fields are described in [Describing a Sequential, VSAM, or ISAM Data Source](#).

You can also specify a one-to-many relationship between two records in different data sources by issuing the JOIN command with the ALL or MULTIPLE option, or defining the join in the Master File. See the *FOCUS® Creating Reports* manual for information about the JOIN command, and see [Defining a Join in a Master File](#), for information about joins in a Master File.

Implementing a One-to-Many Relationship in a FOCUS Data Source

Describe this relationship by specifying a SEGTYPE of Sn or SHn for the child segment. Alternatively, you can join the segments by issuing the JOIN command with the ALL or MULTIPLE option or by specifying a join in the Master File with a SEGTYPE of KM (for a static join) or DKM (for a dynamic join). All of these SEGTYPE values are described in [Describing a FOCUS Data Source](#).

Many-to-Many Relationship

A less commonly used relationship is a many-to-many relationship. Each instance of one segment can be related to one or more instances of a second segment, and each instance of the second segment can be related to one or more instances of the first segment. It is possible to implement this relationship directly between two relational tables, and indirectly between segments of other types of data sources.

Implementing a Many-to-Many Relationship Directly

A direct many-to-many relationship can exist between two relational tables. The STUDENT table contains one row for each student enrolled at a college, and the CLASSES table contains one row for each class offered at the college. Each student can take many classes, and many students can take each class.

The many-to-many type of relationship is illustrated in the following diagram.

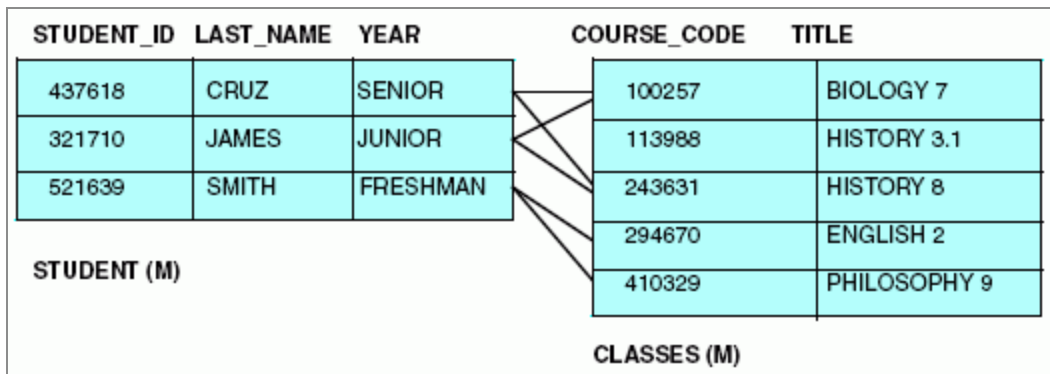

When the M:M relationship is seen from the perspective of either of the two tables, it looks like a 1:M relationship. One student taking many classes (1:M from the perspective of STUDENT), or one class taken by many students (1:M from the perspective of CLASSES). This type of relationship is illustrated in the following diagram.

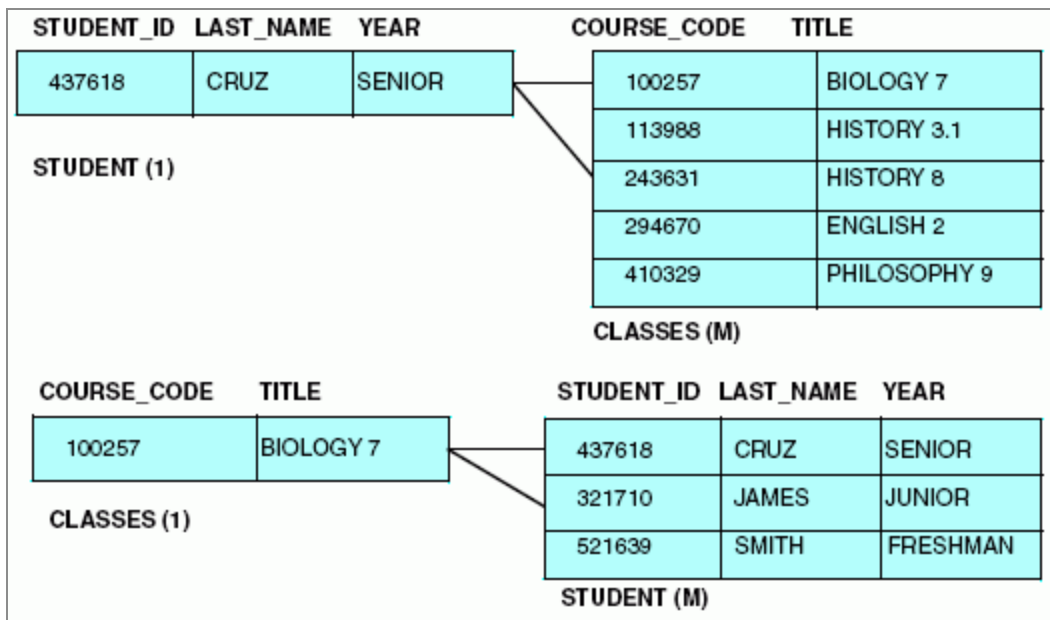

When you report from or update the tables, at any one time the M:M relationship is seen from the perspective of one of the tables (that is, it sees a 1:M relationship). You decide which table perspective to use by making that table the parent (host) segment in the Master File or JOIN command. Describe the join in the Master File or JOIN command as you do for a standard one-to-many relationship.

Implementing a Many-to-Many Relationship Directly

You can use the JOIN command to describe the relationship from the perspective of the STUDENT table as follows:

```
JOIN STUDENT_ID IN STUDENT TO ALL STUDENT_ID IN CLASSES
```

You can describe the relationship from the perspective of the CLASSES table as follows:

```
JOIN COURSE_CODE IN CLASSES TO ALL COURSE_CODE IN STUDENT
```

Implementing a Many-to-Many Relationship Indirectly

Some non-relational data sources cannot represent a many-to-many relationship directly. However, they can represent it indirectly, and you can describe it as such.

Consider the EMPINFO segment in the EMPLOYEE data source and the CLASSES segment in a hypothetical SCHOOL data source. Each instance of EMPINFO describes one employee, and each instance of CLASSES describes one course. Each employee can take many courses, and many employees can take each course, so this is a many-to-many relationship. This type of relationship is illustrated in the following diagram.

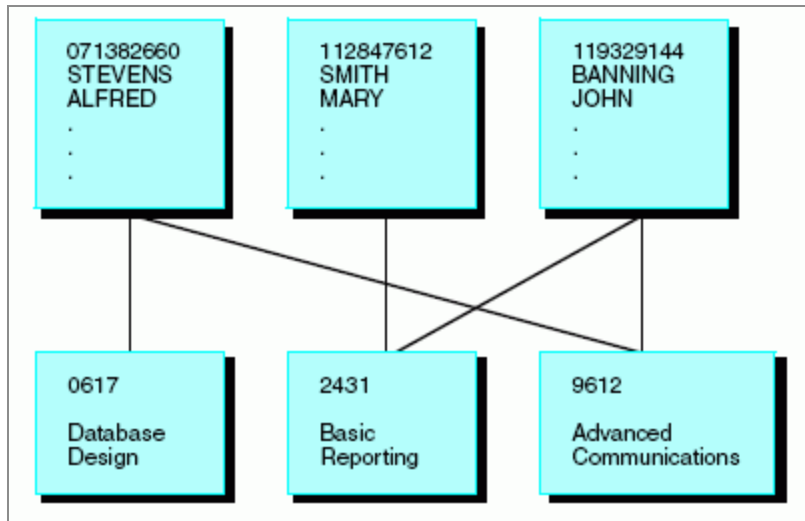

However, because some types of data sources cannot represent such a relationship directly, you must introduce a mediating segment called ENROLLED. This new segment contains the keys from both of the original segments, EMP_ID and CLASS_CODE, representing the relationship between the two original segments. It breaks the M:M relationship into two 1:M relationships. Each instance of EMPINFO can be related to many instances of ENROLLED (since one employee can be enrolled in many classes), and each instance of CLASSES can be related to many instances of ENROLLED (since one class can have many employees enrolled).

These relationships are illustrated in the following diagram.

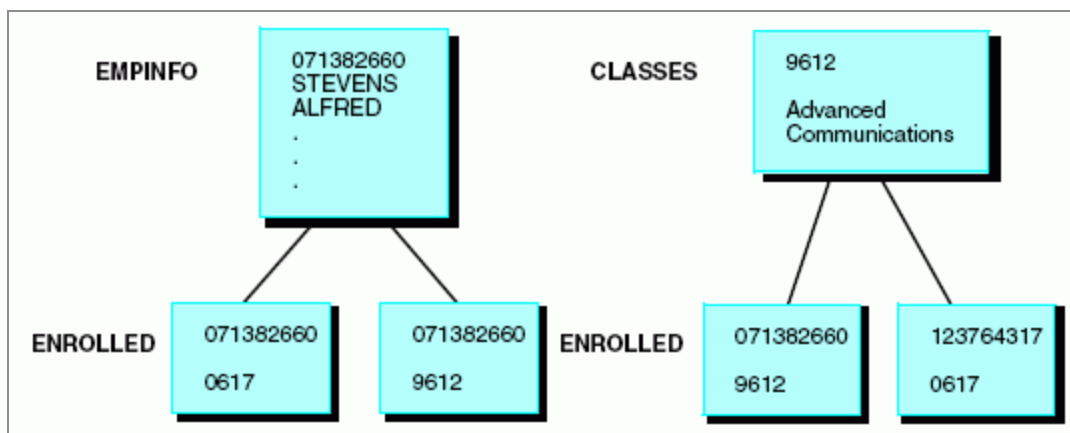

The next step is to make the mediating segment a child of one of the two original segments. You can design the SCHOOL data source so that CLASSES is the root and ENROLLED is the child of CLASSES. Note that when ENROLLED was an unattached segment it explicitly contained the keys (EMP_ID and CLASS_CODE) from both original segments. Yet as part of the SCHOOL data source, CLASS_CODE is implied by the parent-child relationship

with CLASSES, and it can be removed from ENROLLED. You can then join EMPINFO and ENROLLED together.

This type of join is illustrated in the following diagram.

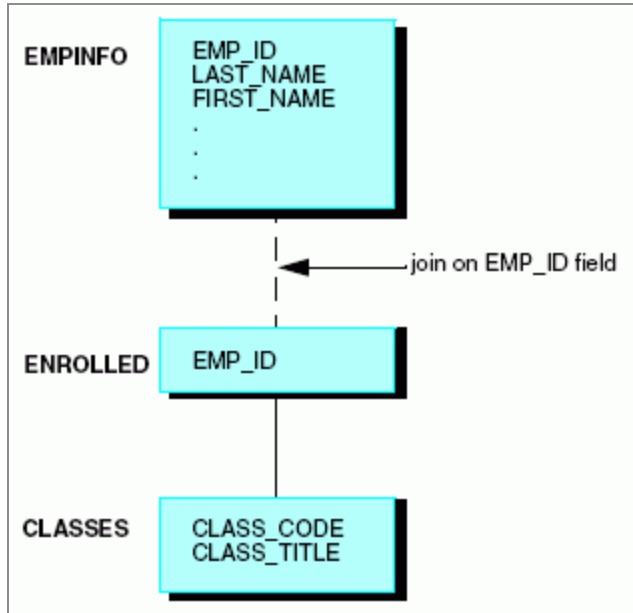

When the original M:M relationship is seen from this perspective, it looks like a 1:M:1 relationship. That is, one employee (EMPINFO) is enrolled many times (ENROLLED), and each enrollment is for a single class (CLASSES).

When you report from or update the new structure at any one time, the relationship is seen from the perspective of one of the original segments (in this case, from EMPINFO or CLASSES). Determine which segment perspective is used by making that segment the parent in the join. Describe the join using the JOIN command, or for FOCUS data sources, in the Master File. If you make the mediating segment, in this case ENROLLED, the child (cross-referenced) segment in the join, you implement the relationship as a standard one-to-many. If you make it the parent (host) segment, you implement the relationship as a standard one-to-one join.

For example, you can use the JOIN command to describe the relationship from the perspective of the CLASSES segment, making ENROLLED the join host:

```
JOIN EMP_ID IN ENROLLED TO EMP_ID IN EMPINFO
```

The new structure is illustrated in the following diagram.

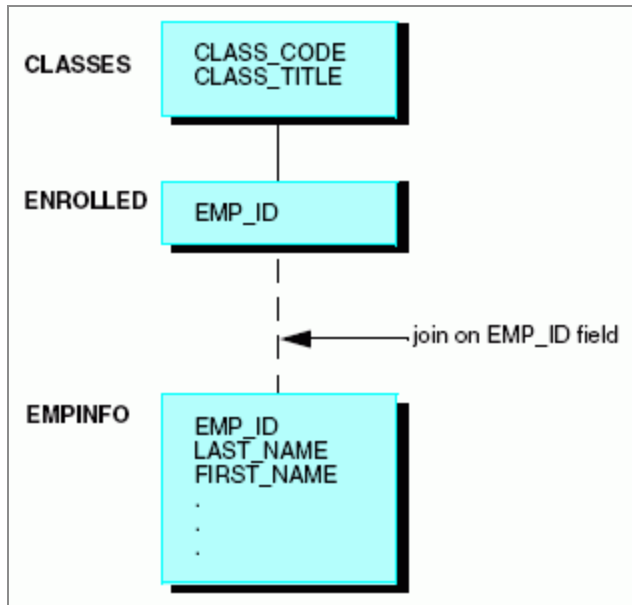

Another example that uses a join defined in the Master File is illustrated by the sample FOCUS data sources EMPLOYEE and EDUCFILE. Here, ATTNDSEG is the mediating segment between EMPINFO and COURSEG.

Recursive Relationships

Generally, you use one-to-one and one-to-many relationships to join two different segments, usually in two different data sources. However, you can also join the same data source, or even the same segment, to itself. This technique is called a recursive join.

See the *FOCUS® Creating Reports* manual for more information on recursive joins.

A Recursive Join With a Single Segment

Assume that you have a single-segment data source called MANAGER, which includes the ID number of an employee, the employee name, and the ID number of the manager of the employee, as shown in the following image.

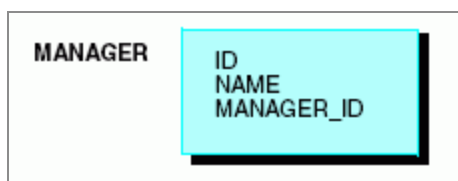

If you want to generate a report showing every employee ID number and name, and every manager ID number and name, you must join the segment to itself. Issue the following command:

```
JOIN MANAGER_ID IN MANAGER TO ID IN MANAGER AS BOSS
```

This creates the following structure:

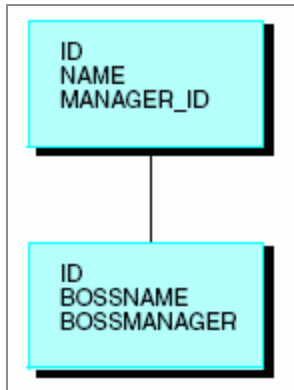

i Note: You can refer to fields uniquely in cross-referenced recursive segments by prefixing them with the first four letters of the join name (BOSS, in this example). The only exception is the cross-referenced field, for which the alias is prefixed instead of the field name.

After you have issued the join, you can generate an answer set that looks like this:

ID	NAME	MANAGER_ID	BOSSNAME
--	----	-----	-----
026255	JONES	837172	CRUZ
308743	MILBERG	619426	WINOKUR
846721	YUTANG	294857	CAPRISTI
743891	LUSTIG	089413	SMITH
585693	CAPRA	842918	JOHNSON

A Recursive Join With Multiple Segments

You can join larger structures recursively as well. For example, consider a two-segment data source called AIRCRAFT that stores a bill-of-materials for an aircraft company. The root segment has the name and description of a part, and the child segment has the name

of a subpart. For each part, there can be many subparts. This type of joined structure is illustrated in the following diagram.

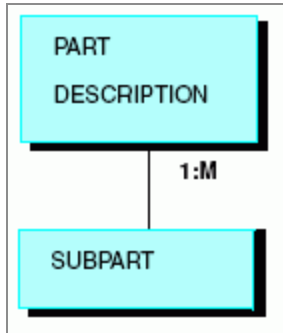

While many of the larger parts are constructed of several levels of subparts, some of these subparts, such as bolts, are used throughout aircraft at many different levels. It is redundant to give each occurrence of a subpart its own segment instance. Instead, use the two-segment design shown previously and then join the data source to itself:

```
JOIN SUBPART IN AIRCRAFT TO PART IN AIRCRAFT AS SUB_PART
```

This produces the following data structure.

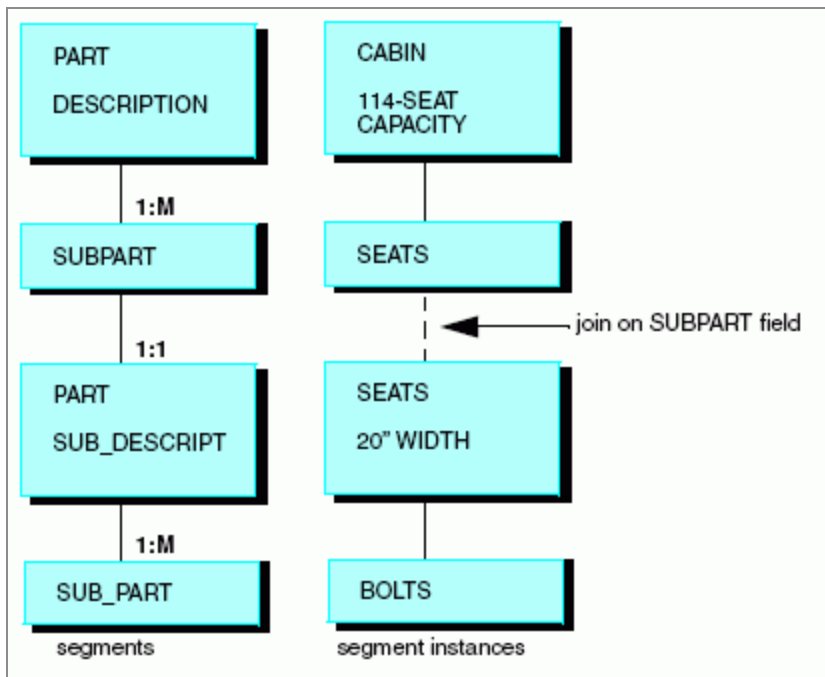

Relating Segments From Different Types of Data Sources

The JOIN command enables you to join segments from different data sources, creating temporary data structures containing related information from otherwise incompatible sources. For example, you can join two Oracle data sources to a FOCUS data source to a VSAM (C-ISAM for WebFOCUS) data source, as illustrated in the following diagram.

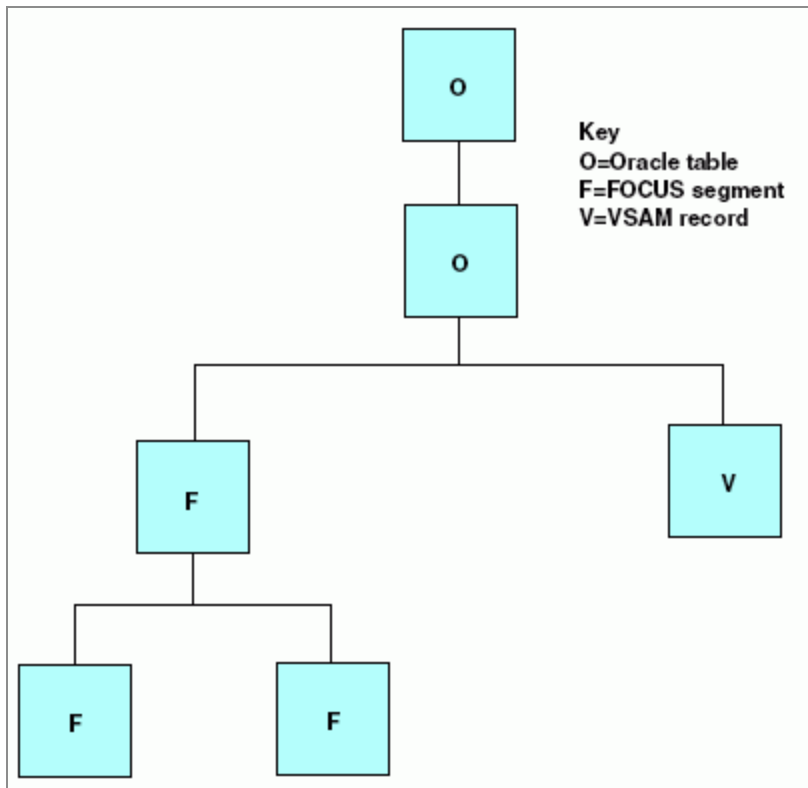

Joins between VSAM and fixed-format data sources are also supported in a Master File, as described in [Defining a Join in a Master File](#).

For detailed information on using the JOIN command with different types of data sources, see the *FOCUS® Creating Reports* manual.

Rotating a Data Source: An Alternate View

If you are using a network data source or certain hierarchical data sources, such as FOCUS, you can rotate the data source after you have described it. This creates an alternate view

that changes some of the segment relationships and enables you to access the segments in a different order. Customizing the access path in this way makes it easier for a given application to access. This type of alternate view is illustrated in the following diagram.

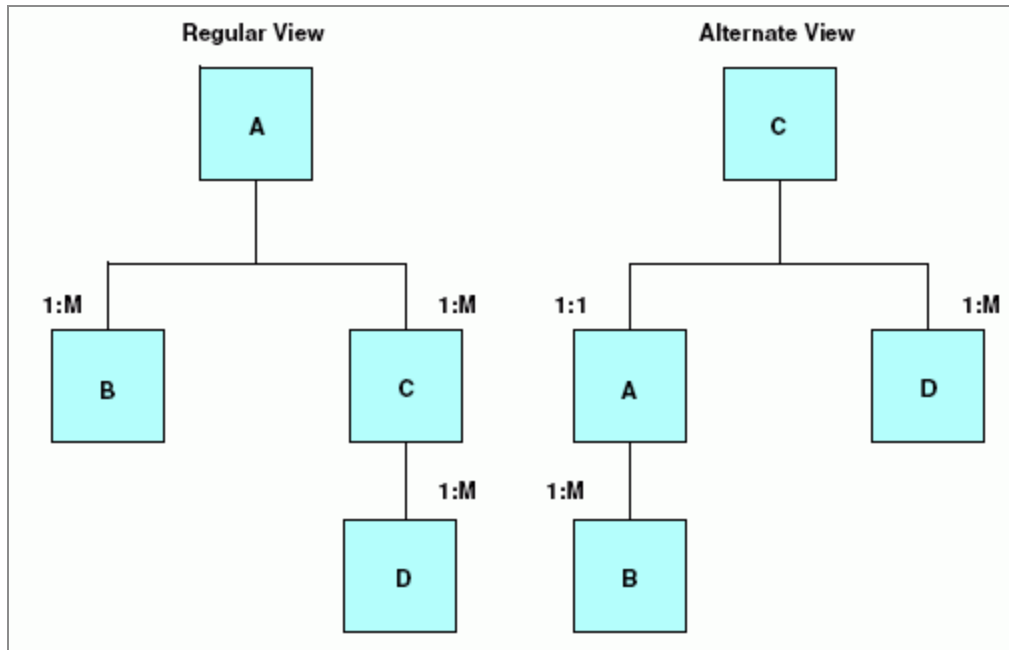

You can join hierarchical and/or network data sources together and then create an alternate view of the joined structure, selecting the new root segment from the host data source.

Using an alternate view can be helpful when you want to generate a report using record selection criteria based on fields found in a lower segment (such as, segment C in the previous diagram). You can report from an alternate view that makes this the root segment. FOCUS then begins its record selection based on the relevant segment, and avoids reading irrelevant ancestral segments.

When you report from a data source using an alternate view, you can access the data more efficiently if both of the following conditions are satisfied:

- The field on which the alternate view is based is indexed. For FOCUS data sources, the alternate view field must include INDEX = I in the Master File.
- You use the field in a record selection test, with the WHERE or IF phrases, and make the selection criteria an equality or range test.

You can request an alternate view on any segment in a data source, except a cross-referenced segment. Request an alternate view with the TABLE command by naming a field from the segment you want to view as the new root segment. The only restriction on

requesting an alternate view is that the field on which it is requested must be a real field in the data source. It cannot be a virtual field.

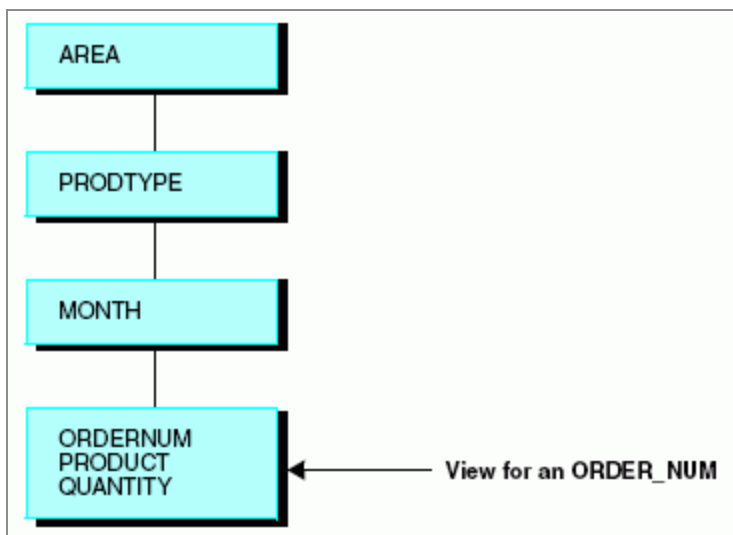
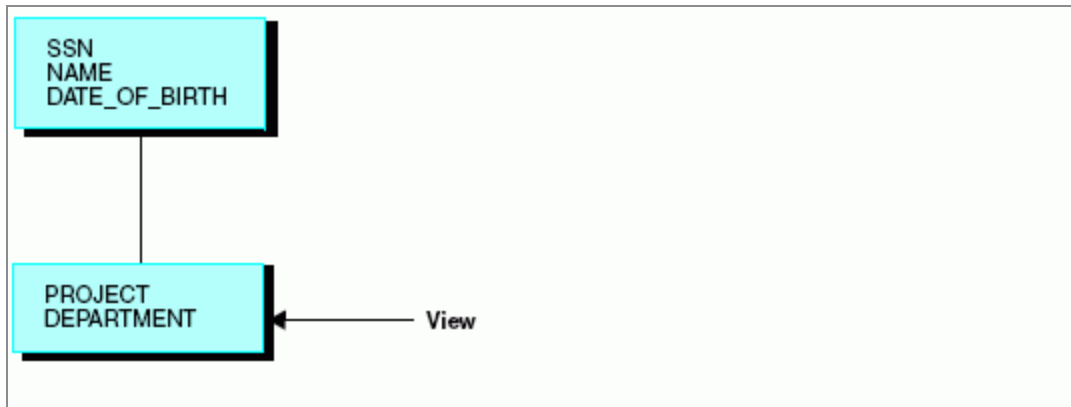

Specify an Alternate View

Append a field name to the file name in the reporting command, using the syntax

```
TABLE FILE filename.fieldname
```

where:

filename

Is the name of the data source on which you are defining the alternate view.

fieldname

Is a field located in the segment that you are defining as the alternate root. It must be a real field, not a temporary field defined with the DEFINE attribute or the DEFINE or COMPUTE commands.

If the field is declared in the Master File with the FIELDTYPE attribute set to I, and you use the alternate view in a report, you must use the field in an equality selection test (such as EQ) or range test.

Specifying an Alternative View

To report from the EMPLOYEE data source using an alternate view that makes the DEDUCT segment an alternate root, issue the following TABLE FILE command:

```
TABLE FILE EMPLOYEE.DED_CODE
```

Other Uses of an Alternate View

Other appropriate situations for using the alternate view capability with the file designer include:

- Data sources with active individual record maintenance. The data sources can be structured for efficient update and management. For example, primary record keys can be placed at the top of the data source, even though requests frequently screen on other fields. The hierarchy does not assist in record selection, so views are used.

Consider a personnel system where the employee identity (SSN) is in the root segment, and the department number of the employee's current project is in a descendant segment. Access to all employees in a given department is obtained using the view from the department.

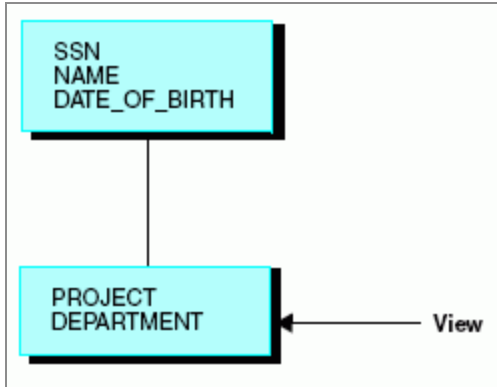

The following diagram further illustrates this type of alternate view.

- Individual records are identified in descendant segments. You can use an alternate view to access a detail segment that is deep in the hierarchy. Consider a sales analysis situation. The data source has ample structure for AREA, PRODUCT TYPE, and MONTH, but a request for a particular ORDER_NUM is easily handled by a view.

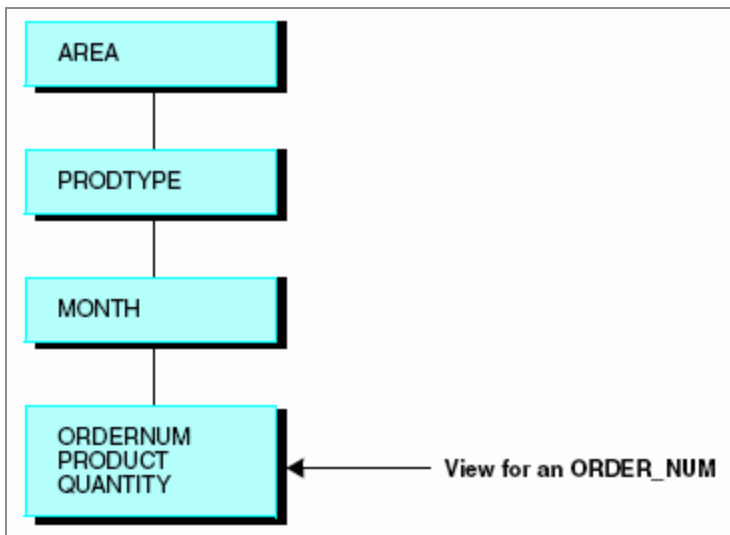

Note that in this view, ORDER_NUM is unique.

- Many missing instances of data. When a particular segment is not often available, screening on it means that fewer segments have to be examined. For instance, if there are 10,000 occurrences of a parent segment, but only 2,000 of these have a given child segment, it is faster to view the data source from the vantage point of these 2,000 when the given child is involved in the screening in the request.

Note that retrieval of a given SSN can also be faster using a view, if the SSN values are indexed.

For more information about using alternate views in report requests, see the *Creating Reports* manual.

Defining a Prefix for Field Titles

If a field in a Master File has a TITLE attribute defined, this title will be used as the column heading for the file on report output, unless the report request specifies an AS name to be used instead.

On the segment level in a Master File, you can define a prefix for the field titles in that segment. This is useful for distinguishing which field is being displayed on report output when field names from different segments have the same title, as in the case when a base synonym is used multiple times in a cluster Master File.

Define a Prefix for Field Titles

```
SEGMENT=segname, ... , SEG_TITLE_PREFIX='prefix', $
```

where:

segname

Is a valid segment name.

'prefix'

Is text to be prefixed to the field title on report output, for any field in the segment that has a TITLE attribute defined. The total length of the SEG_TITLE_PREFIX plus the TITLE string cannot be more than 512 characters. You can split the text across as many as five separate title lines by separating the lines with a comma (,). Include blanks at the end of a column title by including a slash (/) in the final blank position. You must enclose the string within single quotation marks if it includes commas or leading blanks.

If you generate a HOLD file with SET HOLDATTRS ON, the SEG_TITLE_PREFIX will be prefixed to the original TITLE value to generate the TITLE value in the HOLD file.

Defining a Prefix for Field Titles

The following sample shows three segments from the WFLITE Cluster Master File that all reference the WFTIME table. The SEG_TITLE_PREFIX in the WF_RETAIL_TIME_SALES segment is 'Sale, '. The SEG_TITLE_PREFIX in the WF_RETAIL_TIME_DELIVERED segment is 'Delivery, '. The SEG_TITLE_PREFIX in the WF_RETAIL_TIME_SHIPPED segment is 'Shipped, '.

```
SEGMENT=WF_RETAIL_TIME_SALES, CRFILE=wfretail82/dimensions/wf_retail_
time_lite, CRSEGMENT=WF_RETAIL_TIME_LITE, CRINCLUDE=ALL,
  DESCRIPTION='Time Sales Dimension', SEG_TITLE_PREFIX='Sale, ', $
  PARENT=WF_RETAIL_SALES, SEGTYPE=KU, CRJOINTYPE=LEFT_OUTER,
  JOIN_WHERE=WF_RETAIL_SALES.ID_TIME EQ WF_RETAIL_TIME_SALES.ID_TIME;;
$
...
SEGMENT=WF_RETAIL_TIME_DELIVERED, SEGTYPE=KU, PARENT=WF_RETAIL_
SHIPMENTS,
  CRFILE=ibisamp/dimensions/wf_retail_time_lite, CRSEGMENT=WF_RETAIL_
TIME_LITE, CRINCLUDE=ALL, CRJOINTYPE=LEFT_OUTER,
  JOIN_WHERE=ID_TIME_DELIVERED EQ WF_RETAIL_TIME_DELIVERED.ID_TIME;;
  DESCRIPTION='Shipping Time Delivered Dimension', SEG_TITLE_
PREFIX='Delivery, ', $
...
SEGMENT=WF_RETAIL_TIME_SHIPPED, SEGTYPE=KU, PARENT=WF_RETAIL_
SHIPMENTS,
  CRFILE=ibisamp/dimensions/wf_retail_time_lite, CRSEGMENT=WF_RETAIL_
TIME_LITE, CRINCLUDE=ALL, CRJOINTYPE=LEFT_OUTER,
  JOIN_WHERE=ID_TIME_SHIPPED EQ WF_RETAIL_TIME_SHIPPED.ID_TIME;;
  DESCRIPTION='Shipping Time Shipped Dimension', SEG_TITLE_
PREFIX='Shipped, ', $
```

All three segments have the same fields. The SEG_TITLE_PREFIX displays on the report output and indicates which segment the field came from. The following request sums DAYSDELAYED by TIME_QTR:

```
TABLE FILE wflite
SUM DAYSDELAYED
BY TIME_QTR
ON TABLE SET PAGE NOLEAD
ON TABLE SET STYLE *
```

```
GRID=OFF,$
END
```

The column heading on the output shows that the TIME_QTR value is coming from the WF_RETAIL_TIME_SALES segment, as that is the topmost segment with that field name in the WFLITE Master File.

<u>Sale</u> <u>Quarter</u>	<u>Quantity</u> <u>Sold</u>
1	4,188
2	4,105
3	4,007
4	1,623

To specify a different segment, such as WF_RETAIL_TIME_DELIVERED, use a qualified field name in the request.

```
TABLE FILE wflite
SUM DAYSDELAYED
BY WF_RETAIL_TIME_DELIVERED.TIME_QTR
ON TABLE SET PAGE NOLEAD
ON TABLE SET STYLE *
GRID=OFF,$
END
```

The column heading on the output shows that the TIME_QTR value is coming from the WF_RETAIL_TIME_DELIVERED segment.

<u>Delivery</u> <u>Quarter</u>	<u>Days</u> <u>Delayed</u>
1	1,436
2	1,637
3	1,517
4	765

Generating a HOLD File When a Segment Specifies a SEG_TITLE_PREFIX

The title for the field TIME_QTR in the WFTIME Master File is 'Quarter'. The SEG_TITLE_PREFIX for the segment WF_RETAIL_TIME_DELIVERED in the WFLITE Master File is 'Delivery, '. The following request generated a HOLD file named SEGPREFIX with the HOLDATTRS parameter set ON:

```
APP HOLD baseapp
TABLE FILE wflite
SUM DAYSDELAYED
BY WF_RETAIL_TIME_DELIVERED.TIME_QTR
ON TABLE SET HOLDATTRS ON
ON TABLE HOLD AS SEGPREFIX
END
```

The SEGPREFIX Master File generated when you run this request has the title 'Delivery, Quarter' for the TIME_QTR field. This title was created by concatenating the SEG_TITLE_PREFIX value from the WFLITE Master File with the TITLE value from the WFTIME Master File:

```
FIELDNAME=TIME_QTR, ALIAS=E01, USAGE=I2, ACTUAL=I04,
MISSING=ON,
TITLE='Delivery,Quarter', DESCRIPTION='Quarter', $
```

Describing an Individual Field

A field is the smallest meaningful element of data in a data source, but it can exhibit a number of complex characteristics. Master File attributes are used to describe these characteristics.

Field Characteristics

The Master File describes the following field characteristics:

- The name of the field, as identified in the FIELDNAME attribute.
- Another name for the field, either its original name, as defined to its native data management system, or (for some types of data sources) a synonym of your own choosing, or (in some special cases) a pre-defined value that tells how to interpret the field, that you can use as an alternative name in requests. This alternative name is defined by the ALIAS attribute.
- How the field stores and displays data, specified by the ACTUAL, USAGE, and MISSING attributes.

The ACTUAL attribute describes the type and length of the data as it is actually stored in the data source. For example, a field might be alphanumeric and 15 characters in length. Note that FOCUS data sources do not use the ACTUAL attribute, and instead use the USAGE attribute to describe the data as it is formatted. FOCUS handles the storage.

The USAGE attribute, also known by its alias, FORMAT, describes how a field is formatted when it appears in reports. You can also specify edit options, such as date formats, floating dollar signs, and zero suppression.

The MISSING attribute enables null values to be entered into and read from a field in data sources that support null data, such as FOCUS data sources and most relational data sources.

- The option for a field to be virtual, rather than being stored in the data source, and have its value derived from information already in the data source. Virtual fields are specified by the DEFINE attribute.

- Optional field documentation for the developer, contained in the DESCRIPTION attribute.
- Acceptable data-entry values for the field, specified by the ACCEPT attribute.
- Online help information about the field that an end user can display during an application, as described by the HELPMESSAGE attribute.
- An alternative report column title for the field, described by the TITLE attribute.
- A 100-year window that assigns a century value to a two-digit year stored in the field. Two attributes define this window: DEFCENT and YRTHRESH. See the *Developing Applications* manual.

The Field Name: FIELDNAME

Identify a field using FIELDNAME, the first attribute specified in a field declaration in the Master File. You can assign any name to a field, regardless of its name in its native data source. Likewise, for FOCUS data sources, you can assign any name to a field in a new data source.

When you generate a report, each column title in the report has the name of the field displayed in that column as its default, so assigning meaningful field names helps readers of the report. Alternatively, you can specify a different column title within a given report by using the AS phrase in the report request, as described in the *FOCUS® Creating Reports* manual, or a different default column title for all reports by using the TITLE attribute in the Master File, as described in .

Identify the Field Name

```
FIELD[NAME] = field_name
```

where:

field_name

Is the name you are giving this field. It can be a maximum of 512 characters, in a single-byte character set. If you are working in a Unicode environment, this length will be

affected by the number of bytes used to represent each character, as described in the chapter named *Unicode Support* in the *FOCUS® Overview and Operating Environments* manual. Some restrictions apply to names longer than 12 characters, as described in [Restrictions for Field Names](#). The name can include any combination of letters, digits, and underscores (_), and must contain at least one letter. Other characters are not recommended, and may cause problems in some operating environments or when resolving expressions.

Note that field names used in a MODIFY CRTFORM or PROMPT command are limited to 66 characters.

It is recommended that you not use field names of the type Cn, En, and Xn (where n is any sequence of one or two digits) because these can be used to refer to report columns, HOLD file fields, and other special objects.

If you must use special characters because of a field report column title, consider using the TITLE attribute in the Master File to specify the title, as described in .

Usage Notes for FIELDNAME

Note the following rules when using FIELDNAME:

- **Alias.** FIELDNAME has an alias of FIELD.
- **Changes.** In a FOCUS data source, if the INDEX attribute has been set to I (that is, if an index has been created for the field), you cannot change the field name without rebuilding the data source. You may change the name in all other situations.

Restrictions for Field Names

The following restrictions apply to field names and aliases longer than 12 characters:

- You cannot use a field name longer than 12 characters to specify a cross-referenced field in a JOIN command when the cross-referenced file is a FOCUS data source.
- Indexed fields and text fields in FOCUS data sources cannot have field names longer than 12 characters. Indexed fields and text fields in XFOCUS data sources are not subject to this 12 character limitation. Long ALIAS names are supported for both types of data sources.

- A field name specified in an alternate file view cannot be qualified.
- The CHECK FILE command PICTURE and HOLD options display the first 11 characters of long names within the resulting diagram or HOLD file. A caret (>) in the 12th position indicates that the name is longer than the displayed portion.
- ?FF, ? HOLD, ? DEFINE
These display up to 31 characters of the name, and display a caret (>) in the 32nd character to indicate a longer field name.

Using a Qualified Field Name

Requests can qualify all referenced field names and aliases with file and/or segment names, a useful technique when duplicate field names exist across segments in a Master File or in joined data sources.

The names of text fields and indexed fields in FOCUS Master Files are limited to 12 characters. Text fields and indexed fields in XFOCUS Master Files are not subject to this 12-character limitation. However, the aliases for text and indexed fields may be up to 512 characters. Field names up to 512 characters appear as column titles in TABLE reports if there is no TITLE attribute or AS phrase.

The default value for the SET FIELDNAME command, SET FIELDNAME=NEW, activates long and qualified field names. The syntax is described in the *Developing Applications* manual.

Specify a Qualified Field Name in a Request

```
[filename.][segname.]fieldname
```

where:

filename

Is the name of the Master File or tag name. Tag names are used with the JOIN and COMBINE commands.

segname

Is the name of the segment in which the field resides.

fieldname

Is the name of the field.

Qualifying a Field Name

The fully qualified name of the field EMP_ID in the EMPINFO segment of the EMPLOYEE data source is:

```
EMPLOYEE.EMPINFO.EMP_ID
```

Change the Qualifying Character

```
SET QUALCHAR = qualcharacter
```

The period (.) is the default qualifying character. *Developing Applications*

Using a Duplicate Field Name

Field names are considered duplicates when you can reference two or more fields with the same field name or alias. Duplication may occur:

- If a name appears multiple times within a Master File.
- In a JOIN between two or more Master Files, or in a recursive JOIN.
- If you issue a COMBINE and do not specify a prefix.

Duplicate fields (those having the same field name and alias) are not allowed in the same segment. The second occurrence is never accessed, and the following message is generated when you issue CHECK and CREATE FILE:

```
(FOC1829) WARNING. FIELDNAME IS NOT UNIQUE WITHIN A SEGMENT: fieldname
```

Duplicate field names may exist across segments in a Master File. To retrieve such a field, you must qualify its name with the segment name in a request. If a field that appears

multiple times in a Master File is not qualified in a request, the first field encountered in the Master File is the one retrieved.



Note:

If a Master File includes duplicate field names for real fields and/or virtual fields, the following logic is used when retrieving a field:

- If only virtual fields are duplicated, the last virtual field is retrieved.
- If only real fields are duplicated, the first real field is retrieved.
- If a Master File has both a real field and one or more virtual fields with the same name, the last virtual field is retrieved.
- If a field defined outside of a Master File has the same name as a virtual or real field in a Master File, the last field defined outside of the Master File is retrieved.

Reports can include qualified names as column titles. The SET QUALTITLES command, discussed in the *Developing Applications* manual, determines whether reports display qualified column titles for duplicate field names. With SET QUALTITLES=ON, they display qualified column titles for duplicate field names even when the request itself does not specify qualified names. The default value, OFF, disables qualified column titles.

Rules for Evaluating a Qualified Field Name

The following rules are used to evaluate qualified field names:

- The maximum field name qualification is *filename.segname.fieldname*. For example:

```
TABLE FILE EMPLOYEE
PRINT EMPLOYEE.EMPINFO.EMP_ID
END
```

includes EMP_ID as a fully qualified field. The file name, EMPLOYEE, and the segment name, EMPINFO, are the field qualifiers.

Qualifier names can also be duplicated. For example:

```
FILENAME=CAR, SUFFIX=FOC
```

```

SEGNAME=ORIGIN, SEGTYPE=S1
  FIELDNAME=COUNTRY, COUNTRY, A10, $
SEGNAME=COMP, SEGTYPE=S1, PARENT=ORIGIN
  FIELDNAME=CAR, CARS, A16, $
.
.
.
TABLE FILE CAR
PRINT CAR.COMP.CAR
END

```

This request prints the field with alias CARS. Both the file name and field name are CAR.

A field name can be qualified with a single qualifier, either its file name or its segment name. For example:

```

FILENAME=CAR, SUFFIX=FOC
  SEGNAME=ORIGIN, SEGTYPE=S1
    FIELDNAME=COUNTRY, COUNTRY, A10, $
  SEGNAME=COMP, SEGTYPE=S1, PARENT=ORIGIN
    FIELDNAME=CAR, CARS, A16, $
.
.
.
TABLE FILE CAR
PRINT COMP.CAR AND CAR.CAR
END

```

This request prints the field with alias CARS twice.

When there is a single qualifier, segment name takes precedence over file name. Therefore, if the file name and segment name are the same, the field qualified by the segment name is retrieved.

- If a field name begins with characters that are the same as the name of a prefix operator, it may be unclear whether a request is referencing that field name or a second field name prefixed with the operator. The value of the first field is retrieved, not the value calculated by applying the prefix operator to the second field. In the next example, there is a field whose unqualified field name is CNT.COUNTRY and another whose field name is COUNTRY:

```

FILENAME=CAR, SUFFIX=FOC

```



```

SEGNAME=ORIGIN, SEGTYPE=S1
  FIELDNAME=CNT.COUNTRY, ACNTRY, A10, $
  FIELDNAME=COUNTRY, BCNTRY, A10, $
TABLE FILE CAR
SUM CNT.COUNTRY
END

```

In this request, the string CNT.COUNTRY is interpreted as a reference to the field named CNT.COUNTRY, not as a reference to the prefix operator CNT. applied to the field named COUNTRY. Therefore, the request sums the field whose alias is ACNTRY. Although the field name CNT.COUNTRY contains a period as one of its characters, it is an unqualified field name. It is not a qualified name or a prefix operator acting on a field name, neither of which is allowed in a Master File. The request does not count instances of the field whose alias is BCNTRY.

- If a Master File has either a file name or segment name that is the same as a prefix operator, the value of the field within the segment is retrieved in requests, not the value calculated by applying the prefix operator to the field.

For example:

```

FILENAME=CAR, SUFFIX=FOC
  SEGNAME=ORIGIN, SEGTYPE=S1
    FIELDNAME=COUNTRY, COUNTRY, A10, $
  SEGNAME=PCT, SEGTYPE=S1, PARENT=ORIGIN
    FIELDNAME=CAR, CARS, I2, $
TABLE FILE CAR
SUM PCT.CAR PCT.PCT.CAR
BY COUNTRY
END

```

This request sums the field with alias CARS first, and then the percent of CARS by COUNTRY.

- When a qualified field name can be evaluated as a choice between two levels of qualification, the field name with the higher level of qualification takes precedence. In the following example, the choice is between an unqualified field name (the field named ORIGIN.COUNTRY in the ORIGIN segment) and a field name with segment name qualification (the field named COUNTRY in the ORIGIN segment). The field with segment name qualification is retrieved:

```

FILENAME=CAR, SUFFIX=FOC

```

```

SEGNAME=ORIGIN, SEGTYPE=S1
  FIELDNAME=ORIGIN.COUNTRY, OCNTRY, A10, $
  FIELDNAME=COUNTRY, CNTRY, A10, $
TABLE FILE CAR
PRINT ORIGIN.COUNTRY
END

```

This request prints the field with alias CNTRY. To retrieve the field with alias OCNTRY, qualify its field name, ORIGIN.COUNTRY, with its segment name, ORIGIN:

```

PRINT ORIGIN.ORIGIN.COUNTRY

```

- When a qualified field name can be evaluated as a choice between two field names with the same level of qualification, the field with the shortest basic field name length is retrieved. For example:

```

FILENAME=CAR, SUFFIX=FOC
  SEGNAME=CAR, SEGTYPE=S1
    FIELDNAME=CAR.CAR, CAR1, A10, $
  SEGNAME=CAR.CAR, SEGTYPE=S1, PARENT=CAR
    FIELDNAME=CAR, CAR2, A10, $
TABLE FILE CAR
PRINT CAR.CAR.CAR
END

```

In this example, it is unclear if you intend CAR.CAR.CAR to refer to the field named CAR.CAR in the CAR segment, or the field named CAR in the CAR.CAR segment. (In either case, the name CAR.CAR is an unqualified name that contains a period, not a qualified name. Qualified names are not permitted in Master Files.)

No matter what the intention, the qualified field name is exactly the same and there is no obvious choice between levels of qualification.

Since the field with alias CAR2 has the shortest basic field name length, CAR2 is printed. This is different from the prior example, where the choice is between two levels of qualification. To retrieve the CAR1 field, you must specify its alias.

The Field Synonym: ALIAS

You can assign every field an alternative name, or alias. A field alias may be its original name as defined to its native data source, any name you choose, or, in special cases, a

predefined value. The way in which you assign the alias is determined by the type of data source and, in special cases, the role the field plays in the data source. After it has been assigned, you can use this alias in requests as a synonym for the regular field name. Assign this alternative name using the ALIAS attribute.

Using a Field Synonym

In the EMPLOYEE data source, the name CURR_SAL is assigned to a field using the FIELDNAME attribute, and the alternative name CSAL is assigned to the same field using the ALIAS attribute:

```
FIELDNAME = CURR_SAL, ALIAS = CSAL, USAGE = D12.2M, $
```

Both names are equally valid within a request. The following TABLE requests illustrate that they are functionally identical, refer to the same field, and produce the same result:

```
TABLE FILE EMPLOYEE
PRINT CURR_SAL BY EMP_ID
END
```

```
TABLE FILE EMPLOYEE
PRINT CSAL BY EMP_ID
END
```

i Note: In extract files (HOLD, PCHOLD), the field name is used to identify fields, not the ALIAS.

Implementing a Field Synonym

The value you assign to ALIAS must conform to the same naming conventions to which the FIELDNAME attribute is subject, unless stated otherwise. Assign a value to ALIAS in the following way for the following types of data sources:

- **Relational data sources.** ALIAS describes the field original column name as defined in the relational table.
- **Sequential data sources.** ALIAS describes a synonym, or alternative name, that you

can use in a request to identify the field. You can assign any name as the alias. Many users choose a shorter version of the primary name of the field. For example, if the field name is LAST_NAME, the alias might be LN. The ALIAS attribute is required in the Master File, but it can have the value blank.

Note that ALIAS is used in a different way for sequenced repeating fields, where its value is ORDER, as well as for RECTYPE and MAPVALUE fields when the data source includes multiple record types.

- **FOCUS data sources.** ALIAS describes a synonym, or alternative name, that you can use in a request to identify the field. You can assign any name as the alias. Many users choose a shorter version of the primary name of the field. For example, if the field name is LAST_NAME, the alias might be LN. The ALIAS attribute is required in the Master File, but it can have the value blank. Aliases can be changed without rebuilding the data source. If an alias is referred to in other data sources, similar changes may be needed in those Master Files.

The Displayed Data Type: USAGE

This attribute, which is also known as FORMAT, describes how to format a field when displaying it in a report or using it in a calculation.

Specifying a Display Format

For FOCUS data sources, which do not use the ACTUAL attribute, USAGE also specifies how to store the field. For other types of data sources, assign a USAGE value that corresponds to the ACTUAL value, to identify the field as the same data type used to store it in the data source. If the data is store as alphanumeric, assign the USAGE based on how the field will be displayed in your reports. The conversion is done automatically. For instructions on which ACTUAL values correspond to which USAGE values, see the documentation for the specific data adapter.

In addition to selecting the data type and length, you can also specify display options, such as date formatting, floating dollar signs, and zero suppression. Use these options to customize how the field appears in reports.

Specify a Display Format

```
USAGE = t[l[d]
```

where:

t

Is the data type. Valid values are A (alphanumeric), F (floating-point single-precision), D (floating-point double-precision), X extended decimal precision floating-point), I (integer), P (packed decimal), D, W, M, Q, or Y used in a valid combination (date), and TX (text).

l

Is a length specification. The specification varies according to the data type. See the section for each data type for more information. Note that you do not specify a length for date format fields.

d

Is one or more display options. Different data types offer different display options. See the section for each data type for more information.

The complete USAGE value cannot exceed eight characters.

The values that you specify for type and field length determine the number of print positions allocated for displaying or storing the field. Display options only affect displayed or printed fields. They are not active for non-display retrievals, such as extract files.

i **Note:** If a numeric field cannot display with the USAGE format given (for example, the result of aggregation is too large), asterisks appear.

See the sections for each format type for examples and additional information.

Usage Notes for USAGE

Note the following rules when using USAGE:

- **Alias.** USAGE has an alias of FORMAT.

- **Changes.** For most data sources, you can change the type and length specifications of USAGE only to other types and lengths valid for the ACTUAL attribute of that field. You can change display options at any time.

For FOCUS data sources, you cannot change the type specification. You can change the length specification for I, F, D, and P fields, because this affects only display, not storage. You cannot change the decimal part of the length specification for P fields. You can change the length specification of A (alphanumeric) fields only if you use the REBUILD facility. You can change display options at any time.

Data Type Formats

You can specify several types of formats:

- **Numeric.** There are six types of numeric formats: integer, floating-point single-precision, floating-point double-precision, extended decimal precision floating-point (XMATH), decimal precision floating-point (MATH), and packed decimal. See [Numeric Display Options](#) for additional information.
- **Alphanumeric.** You can use alphanumeric format for any value to be interpreted as a sequence of characters and composed of any combination of digits, letters, and other characters.
- **Hexadecimal.** This usage format is used with an Alphanumeric actual format to display or save the hexadecimal representation of the alphanumeric field value.
- **String.** You can use string format for alphanumeric data from Relational data sources that have a STRING data type.
- **Date.** The date format enables you to define date components, such as year, quarter, month, day, and day of week to:
 - Sort by date.
 - Do date comparisons and arithmetic with dates.
 - Validate dates automatically in transactions.

Note that for some applications, such as assigning a date value using the DECODE function, you may wish instead to use alphanumeric, integer, or packed-decimal fields with date display options, which provide partial date functionality.

- **Date-Time.** The date-time format supports both the date and the time, similar to the timestamp data types available in many relational data sources. Date-time fields are

stored in eight, ten, or 12 bytes: four bytes for date and either four, six, or eight bytes for time, depending on whether the format specifies a microsecond or nanosecond. Computations only allow direct assignment within data types. All other operations are accomplished through a set of date-time functions.

- **Text.** Text fields can be used to store large amounts of data and display it with line breaks.

Integer Format

You can use integer format for whole numbers. An integer is any value composed of the digits zero to nine, without a decimal point.

You can also use integer fields with date display options to provide limited date support. This use of integer fields is described in the [Alphanumeric and Numeric Formats With Date Display Options](#).

The integer USAGE type is I. See [Numeric Display Options](#). The format of the length specification is:

`n`

where:

n

Is the number of digits to display. The maximum length is 11 for 32-bit versions of FOCUS and 22 for 64-bit versions, which must include the digits and a leading minus sign if the field contains a negative value. You can also specify a number of decimal places (up to $n - 1$), and the number will display with a decimal point before that number of digits.

For example:

Format	Display
I6	4316

Format	Display
I6.2	43.16
I2	22
I4	-617

Floating-Point Double-Precision Format

You can use floating-point double-precision format for any value composed of the digits zero to nine and an optional decimal point.

The floating-point double-precision USAGE type is D. See [Numeric Display Options](#) for the compatible display options. The length specification format is:

```
t[.s]
```

where:

t

Is the number of characters to display up to a maximum of 33, including the numeric digits, an optional decimal point, and a leading minus sign if the field contains a negative value. The number of significant digits supported varies with the operating environment.

s

Is the number of digits that follow the decimal point. It can be a maximum of 31 and must be less than *t*.

For example:

Format	Display
D8.2	3,187.54
D8	416

In the case of D8.2, the 8 represents the maximum number of places, including the decimal point and decimal places. The 2 represents how many of these eight places are decimal places. The commas are automatically included in the display, and are not counted in the total.

Floating-Point Single-Precision Format

You can use floating-point single-precision format for any number, including numbers with decimal positions. The number is composed of the digits 0 to 9, including an optional decimal point. This format is intended for use with smaller decimal numbers. Unlike floating-point double-precision format, its length cannot exceed nine positions.

The floating-point single-precision USAGE type is F. Compatible display options are described in [Numeric Display Options](#). The length specification format is:

```
t[.s]
```

where:

t

Is the number of characters to display, up to a maximum of 33, including the numeric digits, an optional decimal point, and a leading minus sign if the field contains a negative value. The number of significant digits supported varies with the operating environment.

s

Is the number of digits that follow the decimal point. It can be up to 31 digits and must be less than *t*.

For example:

Format	Display
F5.1	614.2
F4	318

Extended Decimal Precision Floating-Point Format (XMATH)

You can use extended decimal precision floating-point format for any number, including numbers with decimal positions. The number is composed of the digits 0 to 9, including an optional decimal point. Its length cannot exceed 37 significant digits. An extended decimal precision floating-point value is stored as a base 10 number, unlike double-precision and single-precision floating-point values, which are stored as binary numbers. By default, all numeric processing is done using double-precision floating-point. You can change this default using the SET FLOATMAPPING command.

The extended decimal precision floating-point USAGE type is X. Compatible display options are described in [Numeric Display Options](#). The length specification format is:

```
t[.s]
```

where:

t

Is the number of characters to display, up to a maximum of 44, including the numeric digits, an optional decimal point, and a leading minus sign if the field contains a negative value. The number of significant digits supported varies with the operating environment.

s

Is the number of digits that follow the decimal point. It can be up to 37 digits and must be less than *t*.

For example:

Format	Display
X5.1	614.2
X4	318

Decimal Precision Floating-Point Format (MATH)

You can use decimal precision floating-point format for any number, including numbers with decimal positions. The number is composed of the digits 0 to 9, including an optional decimal point. This format is intended for use with smaller decimal numbers. Unlike extended decimal precision floating-point format, its length cannot exceed 15 significant digits. A decimal precision floating-point value is stored as a base 10 number, unlike double-precision and single-precision floating-point values, which are stored as binary numbers. By default, all numeric processing is done using double-precision floating-point. You can change this default using the SET FLOATMAPPING command.

The decimal precision floating-point USAGE type is M. Compatible display options are described in [Numeric Display Options](#). The length specification format is:

```
t[.s]
```

where:

t

Is the number of characters to display, up to a maximum of 34, including the numeric digits, an optional decimal point, and a leading minus sign if the field contains a negative value. The number of significant digits supported varies with the operating environment.

s

Is the number of digits that follow the decimal point. It can be up to 31 digits and must be less than *t*.

For example:

Format	Display
M5.1	614.2
M4	318

Packed-Decimal Format

You can use packed-decimal format for any number, including decimal numbers. A decimal number is any value composed of the digits zero to nine, including an optional decimal point.

You can also use packed-decimal fields with date display options to provide limited date support. See [Alphanumeric and Numeric Formats With Date Display Options](#).

The packed-decimal USAGE type is P. The compatible display options are described in [Numeric Display Options](#).

The length specification format is:

```
t[.s]
```

where:

t

Is the number of characters to display, up to 33, including a maximum of 31 digits, an optional decimal point, and a leading minus sign if the field contains a negative value.

s

Is the number of digits that follow the decimal point. It can be up to 31 digits and must be less than *t*.

For example:

Format	Display
P9.3	4168.368
P7	617542

P fields have two internal lengths, 8 bytes (which supports up to 15 digits) and 16 bytes (which supports up to 33 digits). A USAGE of P1 through P15 is automatically assigned an internal storage consisting of 8 bytes. A USAGE of P16 or greater is assigned an internal storage consisting of 16 bytes.

If your USAGE does not account for the number of digits required to display the stored number, asterisks display instead of a number. This does not necessarily indicate an overflow of the field, just that you did not account for displaying the number of digits that are stored in the field.

Overflow occurs if you attempt to store a number with more digits than can actually fit in the internal storage assigned. Overflow such as this is indicated by storing a number consisting of all 9's, in all operating environments except z/OS. On z/OS, the value 0 (zero) is used. Therefore, if you try to store a number consisting of 16 digits in a packed field assigned 8 bytes of internal storage, the number 999999999999999 (the digit 9 repeated 15 times), or the number zero on z/OS, will be stored in the field instead.

If you assign a USAGE of P1 through P14 to such a field, the 15 digits stored in the field will not be able to be displayed, and you will see asterisks. However, if you assign the USAGE P15 to the field, it will be able to display the 15-digit number stored in the field, so you will see the value 999999999999999 (zero on z/OS). If you see that number for a P15 field, it could be the actual number that was required or it could be a replacement for a number that could not fit.

Numeric Display Options

Display options may be used to edit numeric formats. These options only affect how the data in the field is printed or appears on the screen, not how it is stored in your data source.

Edit Option	Meaning	Effect
-	Minus sign	<p>Displays a minus sign to the right of negative numeric data.</p> <p>Note: Not supported with format options B, E, R, T, DMY, MDY, and YMD.</p>
%	Percent sign	<p>Displays a percent sign (%), along with numeric data. Does not calculate the percent.</p>
p	Percentage	<p>Converts a number to a percentage by multiplying it by 100, and displays it followed by a percent sign (%). Not supported with formats I and P.</p>
A	Negative suppression	<p>Displays the absolute value of the number, but does not affect the stored value.</p> <ul style="list-style-type: none"> • If you propagate a field with a negative suppression USAGE attribute to a HOLD file, the HOLD file contains the signed values. The negative suppression USAGE attribute is also propagated to the HOLD file so that if you run a report request against the HOLD file, the minus signs are suppressed on the report output. • The negative suppression option cannot be used in with the following display options: <ul style="list-style-type: none"> ◦ B (bracket negative). ◦ R (credit negative). ◦ - (right side negative).

Edit Option	Meaning	Effect
a	Automatic abbreviation	Calculates the appropriate abbreviation (K, M, B, or T) to use for displaying the number based on the magnitude of the number. This option uses the appropriate abbreviation for the specific value on the current row and, therefore, each row may have a different abbreviation. For example, 1234567890 displays as 1.23B, while 1234567890000 displays as 1.23T.
b	Billions abbreviation	Displays numeric values in terms of billions. For example, 1234567890 displays as 1.23B.
B	Bracket negative	Encloses negative numbers in parentheses.
c	Comma suppress	Suppresses the display of commas. Used with numeric format options M and N (floating and non-floating dollar sign) and data format D (floating-point double-precision).
C	Comma edit	Inserts a comma after every third significant digit, or a period instead of a comma if continental decimal notation is in use.
DMY	Day-Month-Year	Displays alphanumeric or integer data as a date in the form day/month/year.
E	Scientific notation	Displays only significant digits.

Edit Option	Meaning	Effect
k	Thousands abbreviation	Displays numeric values in terms of thousands. For example, 12345 displays as 12.35K.
L	Leading zeroes	Adds leading zeroes.
m	Millions abbreviation	Displays numeric values in terms of millions. For example, 1234567 displays as 1.23M.
M	Floating currency symbol (\$ for US code page)	<p>Places a floating currency symbol to the left of the highest significant digit. The default currency symbol depends on the code page. You can use the SET CURRSYMB=<i>symbol</i> command to specify up to four characters as the currency symbol or one of the following currency codes:</p> <p>USD or '\$' specifies U. S. dollars.</p> <p>GBP specifies the British pound.</p> <p>JPY specifies the Japanese yen or Chinese yuan.</p> <p>EUR specifies the Euro.</p>
MDY	Month-Day-Year	Displays alphanumeric or integer data as a date in the form month/day/year.
N	Fixed currency symbol (\$ for US code page)	Places a currency symbol to the left of the field. The symbol appears only on the first detail line of each page. The default currency symbol depends on the code page. You can use the SET CURRSYMB= <i>symbol</i> command to specify

Edit Option	Meaning	Effect
		<p>up to four characters as the currency symbol or one of the following currency codes:</p> <p>USD or '\$' specifies U. S. dollars.</p> <p>GBP specifies the British pound.</p> <p>JPY specifies the Japanese yen or Chinese yuan.</p> <p>EUR specifies the Euro.</p>
R	Credit (CR) negative	Places CR after negative numbers.
S	Zero suppress	If the data value is zero, prints a blank in its place.
t	Trillions abbreviation	Displays numeric values in terms of trillions. For example, 1234567890000 displays as 1.23T.
T	Month translation	Displays the month as a three-character abbreviation.
YMD	Year-Month-Day	Displays alphanumeric or integer data as a date in the form year/month/day.

i Note: For abbreviation options k, m, b, t, and a.

- The abbreviated value displays with the number of decimal places specified in the format of the field to which is it returned.
- The format options do not change how a value is stored, just how it is displayed.
- Numbers are rounded prior to display in an abbreviated format. Therefore, when a packed or integer formatted number is displayed in abbreviated form using the EXTENDNUM ON setting, overflow values can be mistaken for correct results.

- These display options are supported with all numeric formats and are compatible with additional display options such as -, B, R, C, c, M, and N.

Using Numeric Display Options

The following table shows examples of the display options that are available for numeric fields.

Option	Format	Data	Display
Minus sign	I2- D7- F7.2-	-21 -6148 -8878	21- 6148- 8878.00-
Percent sign	I2% D7% F3.2%	21 6148 48	21% 6,148% 48.00%
Comma suppression	D6c D7Mc D7Nc	41376 6148 6148	41376 \$6148 \$ 6148
Comma inclusion	I6C	41376	41,376
Zero suppression	D6S	0	
Bracket negative	I6B	-64187	(64187)
Credit negative	I8R	-3167	3167 CR

Option	Format	Data	Display
Leading zeroes	F4L	31	0031
Floating dollar	D7M	6148	\$6,148
Non-floating dollar	D7N	5432	\$ 5,432
Scientific notation	D12.5E	1234.5	0.12345D+04
Year/month/day	I6YMD I8YYMD	980421 19980421	98/04/21 1998/04/21
Month/day/year	I6MDY I8MDYY	042198 04211998	04/21/98 04/21/1998
Day/month/year	I6DMY I8DMYY	210498 21041998	21/04/98 21/04/1998
Month translation	I2MT	07	JUL

Several display options can be combined, as shown:

Format	Data	Display
I5CB	-61874	(61,874)

All of the options may be specified in any order. Options M and N (floating and non-floating dollar sign) and data format D (floating-point double-precision) automatically invoke

option C (comma). Options L and S cannot be used together. Option T (Translate) can be included anywhere in an alphanumeric or integer USAGE specification that includes the M (month) display option. Date display options (D, M, T, and Y), which cannot be used with floating-point fields, are described in [Alphanumeric and Numeric Formats With Date Display Options](#).

Using International System (SI) Numeric Format Abbreviation Options

The International System standard provides numeric abbreviations for very large and very small numbers.

FOCUS supports the following SI-compliant numeric abbreviations. The SI-compliant format uses a two-character display code that consists of a lowercase *n* followed by the SI abbreviation.

Prefix	WebFOCUS Format Code	Size	Example	English Name (American/British)
yotta	nY	10**24	10000000000000000000000000	septillion/quadrillion
zetta	nZ	10**21	1000000000000000000000000	sextillion/trilliard
exa	nE	10**18	1000000000000000000000000	quintillion/trillion
peta	nP	10**15	1000000000000000000000000	quadrillion/billiard
tera	nT	10**12	1000000000000000000000000	trillion/billion
giga	nG	10**9	1000000000	billion/milliard
mega	nM	10**6	1000000	million
kilo	nK	10**3	1000	thousand

Prefix	WebFOCUS Format Code	Size	Example	English Name (American/British)
milli	nm	10**(-3)	0.001	thousandth
micro	nu	10**(-6)	0.000001	millionth
nano	nn	10**(-9)	0.000000001	billionth/milliardth
pico	np	10**(-12)	0.000000000001	trillionth/billionth
femto	nf	10**(-15)	0.000000000000001	quadrillionth/billiardth
atto	na	10**(-18)	0.000000000000000001	quintillionth/trillionth
zepto	nz	10**(-21)	0.0000000000000000001	sextillionth/trilliardth
yocto	ny	10**(-24)	0.0000000000000000000001	septillionth/quadrillionth

The following request uses the mega and giga format options. The decimal precision is controlled by the format which, in this case, is a reformat specified in the SUM command.

```

DEFINE FILE GGSales
NEWDOll/D12.2 = DOLLARS * 100;
END
TABLE FILE GGSales
SUM DOLLARS NEWDOll/D12.5nM AS Millions NEWDOll/D12.3nG AS Billions
BY CATEGORY
ON TABLE SET PAGE NOLEAD
ON TABLE SET STYLE *
GRID=OFF,$
ENDSTYLE
END

```

The output is shown in the following image.

<u>Category</u>	<u>Dollar Sales</u>	<u>Millions</u>	<u>Billions</u>
Coffee	17231455	1,723.14550M	1.723G
Food	17229333	1,722.93330M	1.723G
Gifts	11695502	1,169.55020M	1.170G

Extended Currency Symbol Display Options

You can select a currency symbol for display in report output regardless of the default currency symbol configured for National Language Support (NLS). Use the extended currency symbol format in place of the floating dollar (M) or non-floating dollar (N) display option. When you use the floating dollar (M) or non-floating dollar (N) display option, the currency symbol associated with the default code page is displayed. For example, when you use an American English code page, the dollar sign is displayed.

The extended currency symbol format allows you to display a symbol other than the dollar sign. For example, you can display the symbol for a United States dollar, a British pound, a Japanese yen or Chinese yuan, or the euro. Extended currency symbol support is available for numeric formats (I, D, F, and P).

The extended currency symbol formats are specified as two-character combinations *in the last positions* of any numeric display format. The first character in the combination can be either an exclamation point (!) or a colon (:). The colon is the recommended character because it will work in all ASCII and EBCDIC code pages. The exclamation point is not consistent on all EBCDIC code pages and may produce unexpected behavior if the code page you are using translates the exclamation point differently.

In addition, you can use the SET commands SET CURSYM_D, SET CURSYM_E, SET CURSYM_F, SET CURSYM_G, SET CURSYM_L, and SET CURSYM_Y to redefine the default display characters for the extended currency symbol formats. For example, you can display a euro symbol on the right of the number and add a space between the number and the euro symbol by issuing the SET CURSYM_F command and using the extended currency symbol format :F in the request or Master File.

```
SET CURSYM_F = ' €'
```

For more information, see the *Developing Applications* manual.

The following table lists the supported extended currency display options:

Display Option	Description	Example
:C or !C	<p>The currency symbol is determined by the locale settings. Its display is controlled by the following parameters:</p> <ul style="list-style-type: none"> • CURRENCY_PRINT_ISO specifies whether to display the currency symbol or ISO code. • CURRENCY_DISPLAY controls where the currency symbol or ISO code displays relative to the number. • CURRENCY_ISO_CODE sets the ISO code and, therefore, the currency symbol to use. 	D12.2:C
:d or !d	Fixed dollar sign.	D12.2:d
:D or !D	Floating dollar sign.	D12.2:D
:e or !e	Fixed euro symbol.	F9.2:e
:E or !E	Floating euro symbol on the left side.	F9.2:E
:F or !F	Floating euro symbol on the right side.	F9.2:F
:G or !G	Floating dollar symbol on the right side.	F9.2:G
:l or !l	Fixed British pound sign.	D12.1:l
:L or !L	Floating British pound sign.	D12.1:L
:y or !y	Fixed Japanese yen or Chinese yuan symbol.	I9:y
:Y or !Y	Floating Japanese yen or Chinese yuan symbol.	I9:Y

Extended Currency Symbol Formats

The following guidelines apply:

- A format specification cannot be longer than eight characters.
- The extended currency option must be the last option in the format.
- The extended currency symbol format cannot include the floating (M) or non-floating (N) display option.
- A non-floating currency symbol is displayed only on the first row of a report page. If you use field-based reformatting (as in the example that follows) to display multiple currency symbols in a report column, only the symbol associated with the first row is displayed. In this case, do not use non-floating currency symbols.
- Lowercase letters are transmitted as uppercase letters by the terminal I/O procedures. Therefore, the fixed extended currency symbols can only be specified in a procedure.
- Extended currency symbol formats can be used with fields in floating point, decimal, packed, and integer formats. Alphanumeric and variable character formats cannot be used.

Displaying Extended Currency Symbols

The following request displays the euro symbol.

```
SET PAGE-NUM = OFF
TABLE FILE CENTORD
PRINT PRODFNAME QUANTITY PRICE/D10.2!E
BY ORDER_DATE
WHERE QUANTITY GT 700;
ON TABLE HOLD FORMAT HTML
ON TABLE SET STYLE *
TYPE = REPORT, GRID = OFF,$
ENDSTYLE
END
```

The output is:

Date Of Order:	Product Name:	Quantity:	Price:
2001/10/16	R5 Micro Digital Tape Recorder	726	€89.00
	ZT Digital PDA - Commercial	726	€499.00
2002/03/20	R5 Micro Digital Tape Recorder	751	€89.00
	ZT Digital PDA - Commercial	751	€499.00
2002/04/03	ZC Digital PDA - Standard	751	€299.00
2002/06/07	R5 Micro Digital Tape Recorder	751	€89.00
	ZT Digital PDA - Commercial	751	€499.00
	ZC Digital PDA - Standard	751	€299.00
	R5 Micro Digital Tape Recorder	702	€89.00
	ZT Digital PDA - Commercial	702	€499.00
	ZC Digital PDA - Standard	702	€299.00
2002/06/18	R5 Micro Digital Tape Recorder	751	€89.00
	ZT Digital PDA - Commercial	751	€499.00
2002/10/16	R5 Micro Digital Tape Recorder	798	€89.00
	ZT Digital PDA - Commercial	798	€499.00
2002/12/19	2 Hd VCR LCD Menu	701	€179.00

Select an Extended Currency Symbol

```
numeric_format { : | ! } option
```

where:

numeric_format

Is a valid numeric format (data type I, D, F, or P).

: or !

Is required. The exclamation point is not consistent on all EBCDIC code pages and may produce unexpected behavior if the code page you are using translates the exclamation point differently. The colon does not vary across code pages, so it is the recommended symbol to use.

option

Determines the currency symbol that is displayed, and whether the symbol is floating or non-floating. Possible values are:

- **C.** Displays the currency symbol determined by the locale settings.
- **d.** Displays a non-floating dollar sign.
- **D.** Displays a floating dollar sign.
- **e.** Displays a non-floating euro symbol.
- **E.** Displays a floating euro symbol on the left side.
- **F.** Displays a floating euro symbol on the right side.
- **l.** Displays a non-floating British pound sterling symbol.
- **L.** Displays a floating British pound sterling symbol.
- **y.** Displays a non-floating Japanese yen or Chinese yuan symbol.
- **Y.** Displays a floating Japanese yen or Chinese yuan symbol.

The extended currency option *must be in the last positions in the format.*

Displaying Extended Currency Symbols

The following request displays the euro symbol.

```
SET PAGE-NUM = OFF
TABLE FILE CENTORD
PRINT PRODNAME QUANTITY PRICE/D10.2!E
BY ORDER_DATE
WHERE QUANTITY GT 700;
ON TABLE SET STYLE *
TYPE = REPORT, GRID = OFF,$
ENDSTYLE
END
```

The output is:

Date Of Order:	Product Name:	Quantity:	Price:
2001/10/16	R5 Micro Digital Tape Recorder	726	€89.00
	ZT Digital PDA - Commercial	726	€499.00
2002/03/20	R5 Micro Digital Tape Recorder	751	€89.00
	ZT Digital PDA - Commercial	751	€499.00
2002/04/03	ZC Digital PDA - Standard	751	€299.00
2002/06/07	R5 Micro Digital Tape Recorder	751	€89.00
	ZT Digital PDA - Commercial	751	€499.00
	ZC Digital PDA - Standard	751	€299.00
	R5 Micro Digital Tape Recorder	702	€89.00
	ZT Digital PDA - Commercial	702	€499.00
	ZC Digital PDA - Standard	702	€299.00
2002/06/18	R5 Micro Digital Tape Recorder	751	€89.00
	ZT Digital PDA - Commercial	751	€499.00
2002/10/16	R5 Micro Digital Tape Recorder	798	€89.00
	ZT Digital PDA - Commercial	798	€499.00
2002/12/19	2 Hd VCR LCD Menu	701	€179.00

Locale Display Options for Currency Values

The CURRENCY_ISO_CODE and CURRENCY_DISPLAY parameters can be applied on the field level as display parameters in a Master File DEFINE, a DEFINE command, or in a COMPUTE using the :C display option.

i Note: These parameters are not supported with FORMAT EXL2K report output.

The syntax is:

```
fld/fmt:C(CURRENCY_DISPLAY='pos',
  CURRENCY_ISO_CODE='iso')= expression;
```

where:

fld

Is the field to which the parameters are to be applied.

fmt

Is a numeric format that supports a currency value.

pos

Defines the position of the currency symbol relative to a number. The default value is **default**, which uses the position for the format and currency symbol in effect. Valid values are:

- **LEFT_FIXED.** The currency symbol is left-justified preceding the number.
- **LEFT_FIXED_SPACE.** The currency symbol is left-justified preceding the number, with at least one space between the symbol and the number.
- **LEFT_FLOAT.** The currency symbol precedes the number, with no space between them.
- **LEFT_FLOAT_SPACE.** The currency symbol precedes the number, with one space between them.
- **TRAILING.** The currency symbol follows the number, with no space between them.
- **TRAILING_SPACE.** The currency symbol follows the number, with one space between them.

iso

Is a standard three-character currency code, such as USD for US dollars or JPY for Japanese yen. The default value is **default**, which uses the currency code for the configured language code.

expression

Is the expression that creates the virtual field.

**Note:**

If currency parameters are specified at multiple levels, the order of precedence is:

1. Field level parameters.
2. Parameters set in a request (ON TABLE SET).
3. Parameters set in a FOCEXEC outside of a request.
4. Parameters set in a profile, using the precedence for profile processing.

Specifying Currency Parameters in a DEFINE

The following request creates a virtual field named Currency_parms that displays the currency symbol on the right using the ISO code for Japanese yen, 'JPY'.

```
DEFINE FILE WFLITE
  Currency_parms/D20.2:C(CURRENCY_DISPLAY='TRAILING',CURRENCY_ISO_
  CODE='JPY') = COGS_US;
END
TABLE FILE WFLITE
  SUM COGS_US Currency_parms
  BY BUSINESS_REGION AS 'Region'
  ON TABLE SET PAGE NOLEAD
  ON TABLE SET STYLE *
  GRID=OFF,$
END
```

The output is shown in the following image.

<u>Region</u>	<u>Cost of Goods</u>	<u>Currency_parms</u>
EMEA	\$1,247,925.00	1,247,925.00¥
North America	\$1,457,020.00	1,457,020.00¥
Oceania	\$9,613.00	9,613.00¥
South America	\$235,800.00	235,800.00¥

Rounding

When a value with decimal places is assigned to a numeric field, if there are more decimal places in the value than are specified in the field length description, the value is rounded to an acceptable size before either storing or displaying it. The value is rounded down when the first extra decimal digit is less than five, and rounded up when it is five or greater (although an additional consideration is introduced for floating-point values).

For example, consider a packed-decimal field with two decimal places

```
FIELDNAME = PRESSURE, FORMAT = P8.2, $
```

to which you assign a value with *four* decimal places:

```
PRESSURE = 746.1289
```

The first extra digit (that is, the first one past the specified length of two decimal places), is 8. Since 8 is greater than or equal to five, the value is rounded up, and PRESSURE becomes:

```
746.13
```

The details of rounding are handled in the following ways for the following numeric formats:

- **Integer format.** When a value with decimal places is assigned to an integer field, the value is rounded before it is stored. If the value is assigned using a DEFINE or COMPUTE command, the decimal portion of the value is truncated before it is stored.
- **Packed-decimal format.** When a value is assigned to a packed-decimal field, and the value has more decimal places than the field format specifies, the value is rounded before it is stored.
- **Floating-point single-precision and double-precision formats.** When a value is assigned to one of these fields, and the value has more decimal places than the field format specifies, the full value is stored in the field (up to the limit of precision determined by the field internal storage type). When this value is later displayed, however, it is rounded.

Note that if the decimal portion of a floating-point value as it is internally represented in hexadecimal floating-point notation is repeating (that is, non-

terminating), the repeating hexadecimal number is resolved as a non-repeating slightly lower number, and this lower number is stored as the field value. In these situations, if in the original value of the digit to be rounded had been a five (which would be rounded up), in the stored lower value, it would become a four (which is rounded down).

For example, consider a floating-point double-precision field with one decimal place

```
FIELDNAME = VELOCITY, FORMAT = D5.1, $
```

to which you assign a value with two decimal places:

```
VELOCITY = 1.15
```

This value is stored as a slightly smaller number due to the special circumstances of floating-point arithmetic, as previously described:

```
1.149999
```

While the original number, 1.15, would have been rounded upward to 1.2 (since the first extra digit was 5 or greater), the number as stored is slightly less than 1.15 (1.149999) and, as the first extra digit is now less than 5 (4 in this case), it is rounded down to 1.1. To summarize the process:

```
format:    D5.1
entered:   1.15
stored:    1.149999
rounded:   1.1
displayed: 1.1
```

Alphanumeric Format

You can use alphanumeric format for any value to be interpreted as a sequence of characters and composed of any combination of digits, letters, and other characters.

You can also use alphanumeric fields with date display options to provide limited date support. This use of alphanumeric fields is described in [Alphanumeric and Numeric Formats With Date Display Options](#).

The alphanumeric USAGE type is A. The format of the length specification is n, where n is the maximum number of characters in the field. You can have up to 3968 bytes in an alphanumeric field in a FOCUS file segment, and up to 4096 bytes in an XFOCUS file segment. You can have up to 4095 bytes in a fixed-format sequential data source. You may define the length in the Master File, a DEFINE FILE command, or a COMPUTE command.

For example:

Format	Display
A522	The minutes of today's meeting were submitted...
A2	B3
A24	127-A429-BYQ-49

Standard numeric display options are not available for the alphanumeric data format. However, alphanumeric data can be printed under the control of a pattern that is supplied at run time. For instance, if you are displaying a product code in parts, with each part separated by a "-", include the following in a DEFINE command:

```
PRODCODE/A11 = EDIT (fieldname, '999-999-999') ;
```

where:

fieldname

Is the existing field name, not the newly defined field name.

If the value is 716431014, the PRODCODE appears as 716-431-014. See the *FOCUS® Creating Reports* manual for more information.

Usage Notes for 4K Alphanumeric Fields

- Long alphanumeric fields cannot be indexed.

- For FOCUS data sources, a segment still has to fit on a 4K page. Thus, the maximum length of an alphanumeric field depends on the length of the other fields within its segment.
- Long alphanumeric fields cannot be used in a CRTFORM.
- You can print or hold long alphanumeric fields, but you cannot view them online.
- Long alphanumeric fields may be used as keys.
- Long alphanumeric fields are not supported in Hot Screen.

Hexadecimal Format

You can use the USAGE format *Un* to display the hexadecimal representation of alphanumeric data. The corresponding ACTUAL format is A with two times the length of the USAGE format.

The following operations are supported for hexadecimal format:

- Display.
- Reformatting.
- DEFINE.
- COMPUTE.
- HOLD that produces alphanumeric output.
- SAVE.
- Selection on the alphanumeric representation of the characters.
- Assignment between hexadecimal and alphanumeric fields.

For example, the following request prints the hexadecimal representation of the alphanumeric Category field:

```
TABLE FILE GGSALES
SUM CATEGORY/U10 AS Hex,Category DOLLARS UNITS
BY CATEGORY
ON TABLE SET PAGE NOLEAD
ON TABLE SET STYLE *
GRID=OFF,$
```

```
ENDSTYLE
END
```

The output is shown in the following image.

<u>Category</u>	<u>Hex Category</u>	<u>Dollar Sales</u>	<u>Unit Sales</u>
Coffee	436F6666656520202020	17231455	1376266
Food	466F6F64202020202020	17229333	1384845
Gifts	47696674732020202020	11695502	927880

The following version of the request creates the hexadecimal field in a DEFINE command and adds a HOLD command:

```
APP HOLD baseapp
DEFINE FILE GGSales
HEXCAT/U10 = CATEGORY;
END

TABLE FILE GGSales
SUM HEXCAT DOLLARS UNITS
BY CATEGORY
ON TABLE HOLD AS HOLDHEX FORMAT ALPHA
ON TABLE SET PAGE NOLEAD
ON TABLE SET STYLE *
GRID=OFF,$
ENDSTYLE
END
```

The generated Master File follows. The HEXCAT field has USAGE=U10 and ACTUAL=A20.

```
FILENAME=HOLDHEX , SUFFIX=FIX , IOTYPE=STREAM, $
SEGMENT=HOLDHEX, SEGTYPE=S1, $
FIELDNAME=CATEGORY, ALIAS=E01, USAGE=A11, ACTUAL=A11, $
FIELDNAME=HEXCAT, ALIAS=E02, USAGE=U10, ACTUAL=A20,
$
FIELDNAME=DOLLARS, ALIAS=E03, USAGE=I08, ACTUAL=A08, $
FIELDNAME=UNITS, ALIAS=E04, USAGE=I08, ACTUAL=A08, $
```

String Format

Certain relational data sources support a data type called STRING to store alphanumeric data that has an unlimited length. This type of data can be mapped to the TX data type. However, text fields have limitations on their use in FOCUS sort and selection phrases.

The format specification for a STRING field has no length specification. The length is determined on retrieval. For example:

```
FIELD1/STRING
```

The STRING data type has all of the functionality of alphanumeric data types in FOCUS. The limit to a STRING field value length is 2 GB. It can be propagated to relational data sources that have the STRING data type and to delimited HOLD files, where both the USAGE and ACTUAL formats are generated as STRING.

Date Formats

Date format enables you to define a field as a date, then manipulate the field value and display that value in ways appropriate to a date. Using date format, you can:

- Define date components, such as year, quarter, month, day, and day of week, and extract them easily from date fields.
- Sort reports into date sequence, regardless of how the date appears.
- Perform arithmetic with dates and compare dates without resorting to special date-handling functions.
- Refer to dates in a natural way, such as JAN 1 1995, without regard to display or editing formats.
- Automatically validate dates in transactions.

Date Display Options

The date format does not specify type or length. Instead, it specifies date component options (D, W, M, Q, Y, and YY) and display options. These options are shown in the following chart.

Display Option	Meaning	Effect
D	Day	Prints a value from 1 to 31 for the day.
M	Month	Prints a value from 1 to 12 for the month.
Y	Year	Prints a two-digit year.
YY	Four-digit year	Prints a four-digit year.
T	Translate month or day	Prints a three-letter abbreviation for months in uppercase, if M is included in the USAGE specification. Otherwise, it prints day of week.
t	Translate month or day	Functions the same as uppercase T (described above), except that the first letter of the month or day is uppercase and the following letters are lowercase.*
TR	Translate month or day	Functions the same as uppercase T (described above), except that the entire month or day name is printed instead of an abbreviation.
tr	Translate month or day	Functions the same as lowercase t (described above), except that the entire month or day name is printed instead of an abbreviation.*
Q	Quarter	Prints Q1 - Q4.

Display Option	Meaning	Effect
W	Day-of-Week	If it is included in a USAGE specification with other date component options, prints a three-letter abbreviation of the day of the week in uppercase. If it is the only date component option in the USAGE specification, it prints the number of the day of the week (1-7; Mon=1).
w	Day-of-Week	Functions the same as uppercase W (described above), except that the first letter is uppercase and the following letters are lowercase.*
WR	Day-of-Week	Functions the same as uppercase W (described above), except that the entire day name is printed instead of an abbreviation.
wr	Day-of-Week	Functions the same as lowercase w (described above), except that the entire day name is printed instead of an abbreviation.*
J[UL] or JULIAN	Julian format	Prints date in Julian format.
YYJ[UL]	Julian format	Prints a Julian format date in the format YYYYDDD. The 7-digit format displays the four-digit year and the number of days counting from January 1. For example, January 3, 2001 in Julian format is 2001003.

i Note: When using these display options, be sure they are actually stored in the Master File as lowercase letters. To store characters in lowercase when using TED, you must first issue the command CASE M on the TED command line.

The following combinations of date components are not supported in date formats:

I2M, A2M, I2MD, A2MD

How Field Formats Y, YY, M, and W Are Stored

The Y, YY, and M formats are not smart dates. Smart date formats YMD and YYMD are stored as an offset from the base date of 12/31/1900. Smart date formats YM, YQ, YYM, and YYQ are stored as an offset from the base date 01/1901 on z/OS and 12/1900 on other platforms. W formats are stored as integers with a display length of one, containing values 1-7 representing the days of the week. Y, YY, and M formats are stored as integers. Y and M have display lengths of two. YY has a display length of four. When using Y and YY field formats, keep in mind these two important points:

- The Y formats do not sort based on DEFCENT and YRTHRESH settings. A field with a format of Y does not equal a YY field, as this is not a displacement, but a 4-digit integer.
- It is possible to use DEFCENT and YRTHRESH to convert a field from Y to YY format.

Date Literals Interpretation Table

This table illustrates the behavior of date formats. The columns indicate the number of input digits for a date format. The rows indicate the usage or format of the field. The intersection of row and column describes the result of input and format.

Date Format	1	2	3	4
YYMD	*	*	CC00/0m/dd	CC00/mm/dd
MDYY	*	*	*	*
DMYY	*	*	*	*
YMD	*	*	CC00/0m/dd	CC00/mm/dd
MDY	*	*	*	*
DMY	*	*	*	*
YYM	CC00/0m	CC00/mm	CC0y/mm	CCyy/mm
MYY	*	*	*	*
YM	CC00/0m	CC00/mm	CC0y/mm	CCyy/mm
MY	*	*	0m/CCyy	mm/CCyy
M	0m	mm	*	*

Date Format	1	2	3	4
YYQ	CC00/q	CC0y/q	CCyy/q	0yyy/q
QYY	*	*	q/CCyy	*
YQ	CC00/q	CC0y/q	CCyy/q	0yyy/q
QY	*	*	q/CCyy	*
Q	q	*	*	*
JUL	00/00d	00/0dd	00/ddd	0y/ddd
YYJUL	CC00/00d	CC00/0dd	CC00/ddd	CC0y/ddd
YY	000y	00yy	0yyy	yyyy
Y	0y	yy	*	*
D	0d	dd	*	*
W	w	*	*	*

Date Format	5	6	7	8
YYMD	CC0y/mm/dd	CCyy/mm/dd	0yyy/mm/dd	yyyy/mm/dd
MDYY	0m/dd/CCyy	mm/dd/CCyy	0m/dd/yyyy	mm/dd/yyyy
DMYY	0d/mm/CCyy	dd/mm/CCyy	0d/mm/yyyy	dd/mm/yyyy
YMD	CC0y/mm/dd	CCyy/mm/dd	0yyy/mm/dd	yyyy/mm/dd
MDY	0m/dd/CCyy	mm/dd/CCyy	0m/dd/yyyy	mm/dd/yyyy
DMY	0d/mm/CCyy	dd/mm/CCyy	0d/mm/yyyy	dd/mm/yyyy
YYM	0yyy/mm	yyyy/mm	*	*
MYY	0m/yyyy	mm/yyyy	*	*
YM	0yyy/mm	yyyy/mm	*	*
MY	0m/yyyy	mm/yyyy	*	*
M	*	*	*	*

Date Format	5	6	7	8
YYQ	yyyy/q	*	*	*
QYY	q/yyyy	*	*	*
YQ	yyyy/q	*	*	*
QY	q/yyyy	*	*	*
Q	*	*	*	*
JUL	yy/ddd	*	*	*
YYJUL	CCyy/ddd	0yyy/ddd	yyyy/ddd	*
YY	*	*	*	*
Y	*	*	*	*
D	*	*	*	*
W	*	*	*	*

i Note:

- CC stands for two century digits provided by DFC/YRT settings.
- * stands for message FOC177 (invalid date constant).
- Date literals are read from right to left. Date literals and fields can be used in computational expressions, as described in the *FOCUS® Creating Reports* manual.

Controlling the Date Separator

You can control the date separators when the date appears. In basic date format, such as YMD and MDYY, the date components appear separated by a slash character (/). The same is true for the year-month format, which appears with the year and quarter separated by a blank (for example, 94 Q3 or Q3 1994). The single component formats display just the single number or name.

The separating character can also be a period, a dash, or a blank, or can even be eliminated entirely. The following table shows the USAGE specifications for changing the separating character.

Format	Display
YMD	93/12/24
Y.M.D	93.12.24
Y-M	93-12
YBMDB	93 12 24 (The letter B signifies blank spaces.)

Format	Display
Y M D	931224 (The concatenation symbol () eliminates the separation character.)

**Note:**

- You can change the date separator in the following date formats: YYMD, MDYY, DMY, YMD, MDY, DMY, YYM, MYY, YM, MY, YYQ, QYY, YQ, and QY.
- You cannot change the date separator in a format that includes date translation options.
- You cannot change the date separator (/) in an alphanumeric or numeric format with date display options (for example, I8YYMD).

Date Translation

Numeric months and days can be replaced by a translation, such as JAN, January, Wed, or Wednesday. The translated month or day can be abbreviated to three characters or fully spelled out. It can appear in either uppercase or lowercase. In addition, the day of the week (for example, Monday) can be appended to the beginning or end of the date. All of these options are independent of each other.

Translation	Display
MT	JAN
Mt	Jan

Translation	Display
MTR	JANUARY
Mtr	January
WR	MONDAY
wr	Monday

Using a Date Format

The following chart shows sample USAGE and ACTUAL formats for data stored in a non-FOCUS data source. The Value column shows the actual data value, and the Display column shows how the data appears.

USAGE	ACTUAL	Value	Display
wrMtrDYY	A6YMD	990315	Monday, March 15 1999
YQ	A6YMD	990315	99 Q1
QYY	A6YMD	990315	Q1 1999
YMD	A6	990315	99/03/15

USAGE	ACTUAL	Value	Display
MDYY	A6YMD	990315	03/15/1999

Note that the date attributes in the ACTUAL format specify the order in which the date is stored in the non-FOCUS data source. If the ACTUAL format does not specify the order of the month, day, and year, it is inferred from the USAGE format.

Using a Date Field

A field formatted as a date is automatically validated when entered. It can be entered as a natural date literal (for example, JAN 12 1999) or as a numeric date literal (for example, 011299).

Natural date literals enable you to specify a date in a natural, easily understandable way, by including spaces between date components and using abbreviations of month names. For example, April 25, 1999 can be specified as any of the following natural date literals:

```
APR 25 1999
25 APR 1999
1999 APR 25
```

Natural date literals can be used in all date computations, and all methods of data source updating. The following code shows examples:

```
In WHERE screening           WHERE MYDATE IS 'APR 25 1999'
In arithmetic expressions    MYDATE - '1999 APR 25'
In computational date comparisons  IF MYDATE GT '25 APR 1999'
In replies to MODIFY prompts MYDATE==> APR 25 1999
In comma-delimited data      ...,MYDATE = APR 25 1999, ...
```

Note that natural date literals cannot be used to enter dates using FIDEL.

The following chart describes the format of natural date literals.

Literal	Format
Year-month-day	Four-digit year, uppercase three-character abbreviation, or uppercase full name, of the month, and one-digit or two-digit day of the month (for example, 1999 APR 25 or APRIL 25 1999).
Year-month	Year and month as described above.
Year-quarter	Year as described above, Q plus quarter number for the quarter (for example, 1999 Q3).
Month	Month as described above.
Quarter	Quarter as described above.
Day of week	Three-character, uppercase abbreviation, or full, uppercase name, of the day (for example, MON or MONDAY).

The date components of a natural date literal can be specified in any order, regardless of their order in the USAGE specification of the target field. Date components are separated by one or more blanks.

For example, if a USAGE specification for a date field is YM, a natural date literal written to that field can include the year and month in any order. MAY 1999 and 1990 APR are both valid literals.

Numeric Date Literals

Numeric date literals differ from natural date literals in that they are simple strings of digits. The order of the date components in a numeric date literal must match the order of the date components in the corresponding USAGE specification. In addition, the numeric date literal must include all of the date components included in the USAGE specification. For example, if the USAGE specification is DMY, then April 25 1999 must be represented as:

250499

Numeric date literals can be used in all date computations and all methods of data source updating.

Date Fields in Arithmetic Expressions

The general rule for manipulating date fields in arithmetic expressions is that date fields in the same expression must specify the same date components. The date components can be specified in any order, and display options are ignored. Y or YY, Q, M, W, and D are valid components.

Note that arithmetic expressions assigned to quarters, months, or days of the week are computed modulo 4, 12, and 7, respectively, so that anomalies like fifth quarters and thirteenth months are avoided.

For example, if NEWQUARTER and THISQUARTER both have USAGE specifications of Q, and the value of THISQUARTER is 2, then the following statement gives NEWQUARTER a value of 1 (that is, the remainder of 5 divided by 4):

```
NEWQUARTER = THISQUARTER + 3
```

Converting a Date Field

Two types of conversion are possible: format conversion and date component conversion. In the first case, the value of a date format field can be assigned to an alphanumeric or integer field that uses date display options (see the following section). The reverse conversion is also possible.

In the second case, a field whose USAGE specifies one set of date components can be assigned to another field specifying different date components.

For example, the value of REPORTDATE (DMY) can be assigned to ORDERDATE (Y). In this case, the year is being extracted from REPORTDATE. If REPORTDATE is Apr 27 99, ORDERDATE is 99.

You can also assign the value of ORDERDATE to REPORTDATE. If the value of ORDERDATE is 99, the value of REPORTDATE is Jan 1 99. In this case, REPORTDATE is given values for the missing date components.

Convert a Date Field

```
field1/format = field2;
```

where:

field1

Is a date format field, or an alphanumeric or integer format field using date display options.

format

Is the USAGE (or FORMAT) specification of *field1* (the target field).

field2

Is a date format field, or an alphanumeric or integer format field using date display options. The format types (alphanumeric, integer, or date) and the date components (YY, Y, Q, M, W, D) of *field1* and *field2* do not need to match.

How a Date Field Is Represented Internally

Date fields are represented internally as four-byte binary integers indicating the time elapsed since the date format base date. For each field, the unit of elapsed time is that field smallest date component.

For example, if the USAGE specification of REPORTDATE is MDY, then elapsed time is measured in days, and internally the field contains the number of days elapsed between the entered date and the base date. If you enter the numeric literal for February 13, 1964 (that is, 021364), and then print the field in a report, 02/13/64 appears. If you use it in the equation:

```
NEWDATE = 'FEB 28 1964' - REPORTDATE ;
DAYS/D = NEWDATE ;
```

then the value of DAYS is 15. However, the internal representation of REPORTDATE is a four byte binary integer representing the number of days between December 31, 1900 and February 13, 1964.

Just as the unit of elapsed time is based on a field's smallest date component, so too is the base date. For example, for a YQ field, elapsed time is measured in quarters, and the base date is the first quarter of 1901 on z/OS and the last quarter of 1900 on other platforms. For a YM field, elapsed time is measured in months, and the base date is the first month of 1901 on z/OS and the last month of 1900 on other platforms.

To display blanks or the actual base date in a report, use the SET DATEDISPLAY command described in the *Developing Applications* manual. The default value, OFF, displays blanks when a date matches the base date. ON displays the actual base date value.

You do not need to be concerned with the date format's internal representation, except to note that all dates set to the base date appear as blanks, and all date fields that are entered blank or as all zeroes are accepted during validation and interpreted as the base date. They appear as blanks, but are interpreted as the base date in date computations and expressions.

There are several types of formats you can use to represent date components, and the different types do not represent the same values or offsets.

- Full date formats are stored as the number of days from the base date 12/31/1900.
- Single component formats Y, YY, M, W, and D are stored as integers, not as offsets from a base date.
- Partial date formats YM, YQ, YYM, and YYQ are stored as an offset from the base date 01/1901 on z/OS and 12/1900 on other platforms. Both of these base dates are different from the base date for full component dates (12/31/1900). The offset is expressed in a number of months from the base date for YM and YYM, and as a number of quarters from the base date for YQ and YYQ.
- Full date formats with component display options, such as YYMDy, YYMDm, and YYMDq, display the same values as the component formats such as YYQ and YM. However, they are stored as full component dates (the number of days from the base date 12/31/1900). Therefore, while they display the same types of dates as the component date formats YM, YYM, YQ, and YYQ, their internal offset values are not the same. They are considered different types of date formats and cannot be compared or subtracted.
- When either a partial date or a component date is assigned to a field with a full date format, the missing components are assigned the value 01.

Using Full Date Formats and Component Date Formats

The following request retrieves the current date as a full date field named FULLDATE. It creates a partial date field named PARTIALDATE with format YYM, and a component date field named FULLCOMPONENT with format YYMDm, from the full date field. It then creates two new full dates FULLDATE2 and FULLDATE3 by assigning the partial date to one and the component date to the other.

```
DEFINE FILE GGSALES
FULLDATE/YYMD = '2017/09/12';
PARTIALDATE/YYM =FULLDATE;
FULLCOMPONENT/YYMDm = FULLDATE;
FULLDATE2/YYMD = FULLCOMPONENT;
FULLDATE3/YYMD = PARTIALDATE;
END
TABLE FILE GGSALES
PRINT FULLDATE PARTIALDATE FULLCOMPONENT FULLDATE2 FULLDATE3
BY CATEGORY
WHERE RECORDLIMIT EQ 1
ON TABLE SET PAGE NOLEAD
ON TABLE SET STYLE *
GRID=OFF,$
ENDSTYLE
END
```

The output is shown in the following image. Note that when the partial and component dates are assigned to FULLDATE2 and FULLDATE3, the day assigned is 01 in both cases.

<u>Category</u>	<u>FULLDATE</u>	<u>PARTIALDATE</u>	<u>FULLCOMPONENT</u>	<u>FULLDATE2</u>	<u>FULLDATE3</u>
Coffee	2017/09/12	2017/09	2017/09	2017/09/01	2017/09/01

Displaying a Non-Standard Date Format

By default, if a date field in a non-FOCUS data source contains an invalid date, a message appears and the entire record fails to appear in a report. For example, if a date field contains '980450' with an ACTUAL of A6 and a USAGE of YMD, the record containing that field does not appear. The SET ALLOWCVTERR command enables you to display the rest of the record that contains the incorrect date.

i Note: The ALLOWCVTERR parameter is not supported for virtual fields.

Invoke ALLOWCVTERR

```
SET ALLOWCVTERR = {ON|OFF}
```

where:

ON

Enables you to display a field containing an incorrect date.

OFF

Generates a diagnostic message if incorrect data is encountered, and does not display the record containing the bad data. OFF is the default value.

When a bad date is encountered, ALLOWCVTERR sets the value of the field to either MISSING or to the base date, depending on whether MISSING=ON.

The following chart shows the results of interaction between DATEDISPLAY and MISSING, assuming ALLOWCVTERR=ON and the presence of a bad date.

	MISSING=OFF	MISSING=ON
DATEDISPLAY=ON	Displays Base Date 19001231 or 1901/1	.
DATEDISPLAY=OFF	Displays Blanks	.

DATEDISPLAY affects only how the base date appears. See the *Developing Applications* manual for a description of DATEDISPLAY.

Date Format Support

Date format fields are used in special ways with the following facilities:

- **Dialogue Manager.** Amper variables can function as date fields if they are set to natural date literals. For example:

```
-SET &NOW = 'APR 25 1960' ;
-SET &LATER = '1990 25 APR' ;
-SET &DELAY = &LATER - &NOW ;
```

In this case, the value of &DELAY is the difference between the two dates, measured in days: 10,957.

- **Extract files.** Date fields in SAVB and unformatted HOLD files are stored as four-byte binary integers representing the difference between the field face value and the standard base date. Date fields in SAVE files and formatted HOLD files (for example, USAGE WP) are stored without any display options.
- **GRAPH.** Date fields are not supported as sort fields in ACROSS and BY phrases.
- **FML.** Date fields are not supported within the RECAP statement.

Alphanumeric and Numeric Formats With Date Display Options

In addition to the standard date format, you can also represent a date by using an alphanumeric, integer, or packed-decimal field with date display options (D, M, Y, and T). Note, however, that this does not offer the full date support that is provided by the standard date format.

Alphanumeric and integer fields used with date display options have some date functionality when used with special date functions, as described in the *FOCUS® Creating Reports* manual.

When representing dates as alphanumeric or integer fields with date display options, you can specify the year, month, and day. If all three of these elements are present, then the date has six digits (or eight if the year is presented as four digits), and the USAGE can be:

Format	Display
I6MDY	04/21/98
I6YMD	98/04/21
P6DMY	21/04/98
I8DMYY	21/04/1998

The number of a month (1 to 12) can be translated to the corresponding month name by adding the letter T to the format, immediately after the M. For instance:

Format	Data	Display
I6MTDY	05/21/98	MAY 21 98
I4MTY	0698	JUN 98
I2MT	07	JUL

If the date has only the month element, a format of I2MT displays the value 4 as APR, for example. This is particularly useful in reports where columns or rows are sorted by month. They then appear in correct calendar order. For example, JAN, FEB, MAR, because the sorting is based on the numeric, not alphabetical, values. (Note that without the T display option, I2M is interpreted as an integer with a floating dollar sign.)

Date-Time Formats

The date-time data type supports both the date and time, similar to the timestamp data types available in many relational data sources.

Date-time fields are stored in eight, ten, or 12 bytes: four bytes for date and either four, six, or eight bytes for time, depending on whether the format specifies a microsecond or nanosecond.

Computations only allow direct assignment within data types: alpha to alpha, numeric to numeric, date to date, and date-time to date-time. All other operations are accomplished through a set of date-time functions. See the *Using Functions* manual for information on subroutines for manipulating date-time fields.

Date-time formats can also produce output values and accept input values that are compatible with the ISO 8601:2000 date-time notation standard. A SET parameter and specific formatting options enable this notation.

Enable ISO Standard Date-Time Notation

```
SET DTSTANDARD = {OFF|ON|STANDARD|STANDARDU}
```

where:

OFF

Does not provide compatibility with the ISO 8601:2000 date-time notation standard. OFF is the default value.

ON|STANDARD

Enables recognition and output of the ISO standard formats, including use of T as the delimiter between date and time, use of period or comma as the delimiter of fractional seconds, use of Z at the end of universal times, and acceptance of inputs with time zone information. STANDARD is a synonym for ON.

STANDARDU

Enables ISO standard formats (like STANDARD) and also, where possible, converts input strings to the equivalent universal time (formerly known as Greenwich Mean Time), thus

enabling applications to store all date-time values in a consistent way.

Using SET DTSTANDARD

The following request displays date-time values input in ISO 8601:2000 date-time standard formats. With SET DTSTANDARD=OFF, the request terminates with a (FOC177): INVALID DATE CONSTANT:

```

SET DTSTANDARD = &STAND
DEFINE FILE EMPLOYEE
- * The following input is format YYYY-MM-DDThh:mm:ss.sTZD
DT1/HYYMDs = DT(2004-06-01T19:20:30.45+01:00);
- * The following input has comma as the decimal separator
DT2/HYYMDs = DT(2004-06-01T19:20:30,45+01:00);
DT3/HYYMDs = DT(20040601T19:20:30,45);
DT4/HYYMDUs = DT(2004-06-01T19:20:30,45+01:00);
END
TABLE FILE EMPLOYEE
HEADING CENTER
"DTSANDARD = &STAND "
" "
SUM CURR_SAL NOPRINT DT1 AS 'DT1: INPUT = 2004-06-01T19:20:30.45+01:00'
OVER DT2 AS 'DT2: INPUT = 2004-06-01T19:20:30,45+01:00'
OVER DT3 AS 'DT3: INPUT = 20040601T19:20:30,45'
OVER DT4 AS 'DT4: OUTPUT FORMAT HYYMDUs'
END

```

With DTSTANDARD= STANDARD, the output shows that the input values were accepted, but the time zone offsets in DT1, DT2, and DT4 (+01:00) were ignored on output. The character U in the format for DT4 causes the T separator to be used between the date and the time:

```

DTSANDARD = STANDARD

DT1: INPUT = 2004-06-01T19:20:30.45+01:00    2004-06-01 19:20:30.450
DT2: INPUT = 2004-06-01T19:20:30,45+01:00    2004-06-01 19:20:30.450
DT3: INPUT = 20040601T19:20:30,45            2004-06-01 19:20:30.450
DT4: OUTPUT FORMAT HYYMDUs                    2004-06-01T19:20:30.450

```

With DTSTANDARD= STANDARDU, the output shows that the values DT1, DT2, and DT4 were converted to universal time by subtracting the time zone offsets (+01:00):

```
DTSANDARD = STANDARDU
```

```
DT1: INPUT = 2004-06-01T19:20:30.45+01:00 2004-06-01 18:20:30.450
DT2: INPUT = 2004-06-01T19:20:30,45+01:00 2004-06-01 18:20:30.450
DT3: INPUT = 20040601T19:20:30,45 2004-06-01 19:20:30.450
DT4: OUTPUT FORMAT HYYMDUs 2004-06-01T18:20:30.450
```

Describing a Date-Time Field

In a Master File, the USAGE (or FORMAT) attribute determines how date-time field values appear in report output and forms, and how they behave in expressions and functions. For FOCUS data sources, it also determines how they are stored.

Format type H describes date-time fields. The USAGE attribute for a date-time field contains the H format code and can identify either the length of the field or the relevant date-time display options.

The MISSING attribute for date-time fields can be ON or OFF. If it is OFF, and the date-time field has no value, it defaults to blank.

Describe a Numeric Date-Time Value Without Display Options

This format is appropriate for alphanumeric HOLD files or transaction files.

```
USAGE = Hn
```

where:

n

Is the field length, from 1 to 23, including up to eight characters for displaying the date and up to nine, 12, or 15 characters for the time. For lengths less than 20, the date is truncated on the right.

An eight-character date includes four digits for the year, two for the month, and two for the day of the month, YYYYMMDD.

A nine-character time includes two digits for the hour, two for the minute, two for the second, and three for the millisecond, HHMMSSsss. The millisecond component represents the decimal portion of the second to three places.

A twelve-character time includes two digits for the hour, two for the minute, two for the second, three for the millisecond, and three for the microsecond, HHMMSSsssmmm. The millisecond component represents the decimal portion of the second value to three places. The microsecond component represents three additional decimal places beyond the millisecond value.

A fifteen-character time includes two digits for the hour, two for the minute, two for the second, three for the millisecond, three for the microsecond and three for the nanosecond, HHMMSSsssmmmnnn. The millisecond component represents the decimal portion of the second value to three places. The microsecond component represents three additional decimal places beyond the millisecond value. The nanosecond component represents three additional decimal places beyond the microsecond value.

With this format, there are no spaces between the date and time components, no decimal points, and no spaces or separator characters within either component. The time must be entered using the 24-hour system. For example, the value 19991231225725333444 represents 1999/12/31 10:57:25.333444PM.

Describe a Time-Only Value

```
USAGE = Htimefmt1
```

where:

timefmt1

Is the USAGE format for displaying time only. Hour, minute, and second components are always separated by colons (:), with no intervening blanks. A time value can have a blank immediately preceding an am/pm indicator. For more information, see [Display Options for a Time-Only Value](#).

Display Options for a Time-Only Value

The following table lists the valid time display options for a time-only USAGE attribute. Assume the time value is 2:05:27.123456444 a.m.

Option	Meaning	Effect
H	Hour (two digits). If the format includes the option a, b, A, or B, the hour value is from 01 to 12. Otherwise, the hour value is from 00 to 23, with 00 representing midnight.	Prints a two-digit hour. For example: USAGE = HH prints 02
h	Hour with zero suppression. If the format includes the option a, b, A, or B, the hour value is from 1 to 12. Otherwise, the hour is from 0 to 23.	Displays the hour with zero suppression. For example: USAGE = Hh prints 2
I	Minute (two digits). The minute value is from 00 to 59.	Prints the two-digit minute. For example: USAGE = HHI prints 02:05
i	Minute with zero suppression. The minute value is from 0 to 59.	Prints the minute with zero suppression. This cannot be used together with an hour format (H or h). For example: USAGE = Hi prints 5
S	Second (two digits).	Prints the two-digit second. For example:

Option	Meaning	Effect
	S: 00 to 59	USAGE = HHIS prints 02:05:27
s	Millisecond (three digits, after the decimal point in the second). 000 to 999	Prints the second to three decimal places. For example: USAGE = HHISs prints 02:05:27.123
m	Microsecond (three additional digits after the millisecond). 000 through 999	Prints the second to six decimal places. For example: USAGE = HSsm prints 27.123456
n	Nanosecond (three additional digits after the microsecond). 000 through 999	Prints the second to nine decimal places. For example: USAGE = HSsn prints 27.123456444
x	Instead of using S, s, m, or n, you can specify up to nine decimal places for seconds using the x option, where x is a number from 1 to 9. Alternatively, you can use the s, m, and n formats to display three, six, or nine decimal places.	USAGE = HHI1 prints 02:05:27.1
A	12-hour time display with AM or PM in uppercase.	Prints the hour from 01 to 12, followed by AM or PM. For example: USAGE = HHISA prints 02:05:27AM
a	12-hour time display with am or pm in lowercase.	Prints the hour from 01 to 12, followed by am or pm. For example:

Option	Meaning	Effect
		USAGE = HHISa prints 02:05:27am
B	12-hour time display with AM or PM in uppercase, with a blank space before the AM or PM.	Prints the hour from 01 to 12, followed by a space and then AM or PM. For example: USAGE = HHISB prints 02:05:27 AM
b	12-hour time display with am or pm in lowercase, with a blank space before the am or pm.	Prints the hour from 01 to 12, followed by a space followed by am or pm. For example: USAGE = HHISb prints 02:05:27 am
Z	24-hour time display with Z to indicate universal time. Z is incompatible with AM/PM output.	Prints the hour from 01 to 24, followed by Z. For example: USAGE = HHISZ prints 14:30 [:20.99]Z

When the format includes more than one time display option:

- The options must appear in the order hour, minute, second, millisecond, microsecond, nanosecond.
- The first option must be either hour, minute, or second.
- No intermediate component can be skipped. If hour is specified, the next option must be minute. It cannot be second.

i Note: Unless you specify one of the AM/PM time display options, the time component appears using the 24-hour system.

Describe a Date-Time Value

```
USAGE = Hdatefmt [separator] [timefmt2]
```

where:

datefmt

Is the USAGE format for displaying the date portion of the date-time field. For more information, see [Display Options for the Date Component of a Date-Time Field](#).

separator

Is a separator between the date components. The default separator is a slash (/). Other valid separators are: period (.), hyphen (-), blank (B), or none (N). With translated months, these separators can only be specified when the k option is not used.

With the STANDARD and STANDARDU settings, the separator for dates is always hyphen. The separator between date and time is blank by default. However, if you specify the character U as the separator option, the date and time will be separated by the character T.

timefmt2

Is the format for a time that follows a date. Time is separated from the date by a blank. Time components are separated from each other by colons. Unlike the format for time alone, a time format that follows a date format consists of at most two characters: a single character to represent all of the time components that appear and, optionally, one character for an AM/PM option. For more information, see [Display Options for the Date Component of a Date-Time Field](#).

Display Options for the Date Component of a Date-Time Field

The date format can include the following display options, as long as they conform to the allowed combinations. In the following table, assume the date is February 5, 1999.

Option	Meaning	Example
Y	2-digit year	99

Option	Meaning	Example
YY	4-digit year	1999
M	2-digit month (01 - 12)	02
MT	Full month name	February
Mt	Short month name	Feb
D	2-digit day	05
d	Zero-suppressed day. A blank space replaces the zero.	5
e	Zero-removed day. The day number is shifted to the left, and any components to the right of this are shifted to the left. Requires a date separator.	5
o	Zero-removed month. Automatically implements the e option for a zero-removed day. The month and day numbers are shifted to the left, and any components to the right of these are also shifted. Required a date separator.	5
k	For formats in which month or day is followed by year, and month is translated to a short or full name, k separates the year from the day with a comma and	USAGE = HMtDkYY

Option	Meaning	Example
	blank. Otherwise, the separator is a blank.	prints Feb 05, 1999

i Note: Unless you specify one of the AM/PM time display options, the time component uses the 24-hour system.

Using Zero Removal for Date-Time Month and Day Numbers

The following request creates the date-time value 01/01/2013. It then displays this value using:

- Normal month and day numbers, format HMDYY.
- Month removal and day removal, format HoeYY.
- Month removal without day removal (which forces day removal), format HodYY.
- Day removal without month removal, format HMeYY. Note that month removal is not forced by day removal.

```
DEFINE FILE GGSALES
DATE1A/HMDYY = DT(01/01/2013);
DATE1B/HoeYY = DATE1A;
DATE1C/HodYY = DATE1A;
DATE1D/HMeYY = DATE1A;
END
TABLE FILE GGSALES
SUM DOLLARS NOPRINT
DATE1A AS 'HMDYY'
DATE1B AS 'HoeYY'
DATE1C AS 'HodYY'
DATE1D AS 'HMeYY'
ON TABLE SET PAGE NOPAGE
END
```

The output is:

HMDYY	HoeYY	HodYY	HMeYY
-----	-----	-----	-----
01/01/2013	1/1/2013	1/1/2013	01/1/2013

Comparing Zero Suppression With Zero Removal

The following request creates two dates with date-time formats in which the date component has a leading zero (01). In the first date, the day component is the first component and displays on the left. In the second date, the day component is the second component and displays in the middle. The request prints these dates:

- With all zeros displayed, format HDMYY.
- With zero suppression for the day component, format HdMYy.
- With zero removal for the day component, format HeMYy.

```

DEFINE FILE GGSales
DATE1A/HDMYY = DT(01/12/2012);
DATE2A/HMDYY = DT(12/01/2012);
DATE1B/HdMYy = DATE1A;
DATE2B/HMdYY = DATE2A;
DATE1C/HeMYy = DATE1A;
DATE2C/HMeYY = DATE2A;
END
TABLE FILE GGSales
SUM DOLLARS NOPRINT
DATE1A AS 'HDMYY'
DATE2A AS '' OVER
DATE1B AS 'HdMYy'
DATE2B AS '' OVER
DATE1C AS 'HeMYy'
DATE2C AS ''
ON TABLE SET PAGE NOPAGE

```

On the output, the first row shows the date with all zeros displayed. The second row shows zero suppression of the day number, where the zero has been replaced by a blank space so that all the components are aligned with the components on row 1. The last row shows zero removal, where the zero has been removed from the day number, and all of the remaining characters have been shifted over to the left:

HDMYY	01/12/2012	12/01/2012
HdMYY	1/12/2012	12/ 1/2012
HeMYY	1/12/2012	12/1/2012

Display Options for the Time Component of a Date-Time Field

The following table lists the valid options. Assume the date is February 5, 1999 and the time is 02:05:25.444555333 a.m.

Option	Meaning	Example
H	Prints hour.	USAGE = HYYMDH prints 1999/02/05 02
I	Prints hour:minute.	USAGE = HYYMDI prints 1999/02/05 02:05
S	Prints hour:minute:second.	USAGE = HYYMDS prints 1999/02/05 02:05:25
s	Prints hour:minute:second.millisecond.	USAGE = HYYMDs prints 1999/02/05 02:05:25.444
m	Prints hour:minute:second.microsecond.	USAGE = HYYMDm prints 1999/02/05 02:05:25.444555
n	Prints hour:minute:second.nanosecond.	USAGE = HYYMDn prints 1999/02/05 02:05:25.444555333
x	Instead of using S, s, m, or n, you can specify up to nine decimal places for seconds using the x	USAGE = HYYMD1 prints 1999/02/05 02:05:25.4

Option	Meaning	Example
	option, where x is a number from 1 to 9. Alternatively, you can use the s, m, and n formats to display three, six, or nine decimal places.	
A	Prints AM or PM. This uses the 12-hour system and causes the hour to be printed with zero suppression.	USAGE = HYYMDSA prints 1999/02/05 2:05:25AM
a	Prints am or pm. This uses the 12-hour system and causes the hour to be printed with zero suppression.	USAGE = HYYMDSa prints 1999/02/05 2:05:25am
B	Prints AM or PM, preceded by a blank space. This uses the 12-hour system and causes the hour to be printed with zero suppression.	USAGE = HYYMDSB prints 1999/02/05 2:05:25 AM
b	Prints am or pm, preceded by a blank space. This uses the 12-hour system and causes the hour to be printed with zero suppression.	USAGE = HYYMDSb prints 1999/02/05 2:05:25 am
Z	Prints Z to indicate universal time. This uses the 24-hour system. Z is incompatible with AM/PM output.	USAGE = HHISZ prints 14:30 [:20.99]Z

The date components can be in any of the following combinations and order:

- Year-first combinations: Y, YY, YM, YYM, YMD, YYMD.
- Month-first combinations: M, MD, MY, MYY, MDY, MDYY.
- Day-first combinations: D, DM, DMY, DMYY.

Date-Time Usage Notes

- In order to have a time component, you must have a day component.
- If you use the *k* option, you cannot change the date separator.

Character Format *AnV*

The character format *AnV* is supported in Master Files for FOCUS, XFOCUS, and relational data sources. This format is used to represent the VARCHAR (variable length character) data types supported by relational database management systems.

For relational data sources, *AnV* keeps track of the actual length of a VARCHAR column. This information is important when the value is used to populate a VARCHAR column in a different RDBMS. It affects whether trailing blanks are retained in string concatenation and, for Oracle, string comparisons (the other relational engines ignore trailing blanks in string comparisons).

In a FOCUS or XFOCUS data source, *AnV* does not provide true variable length character support. It is a fixed-length character field with two extra leading bytes to contain the actual length of the data stored in the field. This length is stored as a short integer value occupying two bytes. Trailing blanks entered as part of an *AnV* field count in its length.

i Note: Because of the two bytes of overhead and the additional processing required to strip them, *AnV* format is not recommended for use in non-relational data sources.

Specify *AnV* Fields in a Master File

```
FIELD=name, ALIAS=alias, USAGE=AnV [,ACTUAL=AnV] , $
```

where:

n

Is the size (maximum length) of the field. It can be from 1 to 4093. Note that because of the additional two bytes used to store the length, an A4093V field is actually 4095 bytes long. A size of zero (A0V) is not supported. The length of an instance of the field can be zero.

i **Note:** HOLD FORMAT ALPHA creates an ACTUAL format of AnW in the Master File. See [Propagating an AnV Field to a HOLD File](#).

Specifying the AnV Format in a Master File

The following represents a VARCHAR field in a Master File for a Db2 data source with size 200:

```
$ VARCHAR FIELD USING AnV
  FIELD=VARCHAR200, ALIAS=VC200, USAGE=A200V, ACTUAL=A200V,MISSING=ON , $
```

The following represents an AnV field in a Master File for a FOCUS data source with size 200:

```
FIELD=ALPHAV, ALIAS=AV200, USAGE=A200V, MISSING=ON , $
```

If a data source has an AnV field, specify the following in order to create a HOLD FORMAT ALPHA file without the length designator:

```
FIELD=ALPHA, USAGE=A25, ACTUAL=A25V, $
```

or

```
DEFINE ...
  ALPHA/A25 = VARCHAR ;
END
```

or

```
COMPUTE ALPHA/A25 = VARCHAR ;
```

In order to alter or create a Master File to include *AnV*, the data must be converted and the length added to the beginning of the field. For example, issue a HOLD command when the field is described as follows:

```
FIELD=VARCHAR, ,USAGE=A25V, ACTUAL=A25, $
```

or

```
DEFINE ...  
  VARCHAR/A25V = ALPHA ;  
END
```

or

```
COMPUTE VARCHAR/A25V = ALPHA ;
```

Usage Notes for *AnV* Format

- *AnV* can be used anywhere that *An* can be used, except for the restrictions listed in these notes.
- Full FOCUS and SQL operations are supported with this data type, including CREATE FILE for relational data sources.
- Joins are not supported between *An* and *AnV* fields.
- DBCS characters are supported. As with the *An* format, the number of characters must fit within the 4K data area.
- COMPUTE and DEFINE generate the data type specified on the left-hand side.
- Conversion between *AnV* and TX fields is not supported.
- *AnV* fields cannot have date display options.

Propagating an AnV Field to a HOLD File

When a user propagates an AnV field to a sequential data source using the HOLD FORMAT ALPHA command, the two-byte integer length is converted to a six-digit alphanumeric length. The field in the HOLD file consists of this six-digit number followed by the character data. The format attributes for this field are:

```
... USAGE= $AnV$ , ACTUAL= $AnW$ 
```

AnW is created as a by-product of HOLD FORMAT ALPHA. However, it can be read and used for input as necessary. The number of bytes occupied by this field in the HOLD file is $6+n$.

Propagating an AnV Field to a HOLD File

The A39V field named TITLEV, is propagated to the HOLD file as:

```
FIELDNAME = TITLEV ,E03 ,A39V ,A39W , $\$$ 
```

In a binary HOLD file, the USAGE and ACTUAL formats are AnV , although the ACTUAL format may be padded to a full 4-byte word. The number of bytes occupied by this field in the HOLD file is $2+n$.

When an AnV field is input into a data source, all bytes in the input field beyond the given length are ignored. These bytes are set to blanks as part of the input process.

When a user creates a relational data source using the HOLD FORMAT *sqlengine* command, the AnV field generates a VARCHAR column in the relational data source.

For example, the A39V field named TITLEV, is propagated to a HOLD FORMAT DB2 file as:

```
FIELDNAME = 'TITLEV', 'TITLEV', A39V, A39V , $\$$ 
```

Text Field Format

You can store any combination of characters as a text field.

Specify a Text Field in a Master File

```
FIELD = fieldname, ALIAS = aliasname, USAGE = TXn[F],$
```

where:

fieldname

Is the name you assign the text field.

aliasname

Is an alternate name for the field name.

n

Is the output display length in TABLE for the text field. The display length may be between 1 and 256 characters.

F

Is used to format the text field for redisplay when TED is called using ON MATCH or ON NOMATCH. When F is specified, the text field is formatted as TX80 and appears. When F is not specified, the field reappears exactly as entered.

For example, the text field in the COURSES data source is specified as:

```
FIELD = DESCRIPTION, ALIAS = CDESC, USAGE = TX50,$
```

All letters, digits, and special characters can be stored with this format. The following are some sample text field formats.

Format	Display
TX50	This course provides the DP professional with the skills needed to create, maintain, and report from FOCUS data sources.
TX35	This course provides the DP professional with

Format	Display
	<pre>the skills needed to create, maintain, and report from FOCUS data sources.</pre>

The standard edit options are not available for the text field format.

Usage Notes for Text Field Format

- Conversion between text and alphanumeric fields is supported in DEFINE and COMPUTE commands.
- Multiple text fields are supported, and they can be anywhere in the segment.

The Stored Data Type: ACTUAL

ACTUAL describes the type and length of data as it is actually stored in the data source. While some data types, such as alphanumeric, are universal, others differ between different types of data sources. Some data sources support unique data types. For this reason, the values you can assign to the ACTUAL attribute differ for each type of data source.

ACTUAL Attribute

This attribute describes the type and length of your data as it actually exists in the data source. The source of this information is your existing description of the data source (such as a COBOL FD statement). The ACTUAL attribute is one of the distinguishing characteristics of a Master File for non-FOCUS data sources. Since this attribute exists only to describe the format of a non-FOCUS data structure, it is not used in the Master File of a FOCUS data structure.

If your data source has a date stored as an alphanumeric field and you need to convert it to a FOCUS date for sorting or aggregation in a report, you can use the DATEPATTERN attribute in the Master File. FOCUS then uses the pattern specified to convert the alphanumeric date to a FOCUS date.

Specify the ACTUAL Attribute

ACTUAL = format

where:

format

Consists of values taken from the following table, which shows the codes for the types of data that can be read.

ACTUAL Type	Meaning
DATE	Four-byte integer internal format, representing the difference between the date to be entered and the date format base date.
An	<p>Where $n = 1-4095$ for fixed-format sequential and VSAM data sources, and $1-256$ for other non-FOCUS data sources. Alphanumeric characters A-Z, 0-9, and the special characters in the EBCDIC display mode.</p> <p>An accepts all the date-time string formats, as well as the Hn display formats. ACTUAL=An also accepts a date-time field as it occurs in an alphanumeric HOLD file or SAVE file.</p> <p>Alphanumeric format can also be used with the hexadecimal USAGE format (U). The length of the ACTUAL has to be twice the length of the USAGE.</p>
D8	Double-precision, floating-point numbers, stored internally in eight bytes.
F4	Single-precision, floating-point numbers, stored internally in four bytes.
Hn	H8, H10, or H12 accepts a date-time field as it occurs in a binary HOLD file or SAVB file.

ACTUAL Type	Meaning
In	<p>Binary integers:</p> <p>I1 = single-byte binary integer.</p> <p>I2 = half-word binary integer (2 bytes).</p> <p>I4 = full-word binary integer (4 bytes).</p> <p>I8 = double-word binary integer (8 bytes).</p> <p>Note: The USAGE must be P or D. Decimals are honored, with proper conversion to the decimals of the P or D USAGE.</p>
M8	<p>Decimal precision floating-point numbers (MATH), stored internally in eight bytes.</p>
Pn	<p>Where $n = 1-16$. Packed decimal internal format. n is the number of bytes, each of which contains two digits, except for the last byte which contains a digit and the sign (+ or -). For example, P6 means 11 digits plus a sign.</p>
STRING	<p>For Relational data sources that have a STRING data type. There is no length specification.</p>
X16	<p>Extended decimal precision floating-point numbers (XMATH), stored internally in 16 bytes.</p>
Zn	<p>Where $n = 1-31$. Zoned decimal internal format. n is the number of digits, each of which takes a byte of storage. The last digit contains a digit and the sign.</p> <p>If the field contains an assumed decimal point, represent the field with an ACTUAL format of Zn and a USAGE format of $Pm.d$, where m is the total number of digits in the display plus the assumed decimal point, d is the number of decimal places, and m must be at least 1 greater than the value of n. For example, a field with ACTUAL=Z5 and one decimal place needs USAGE=P6.1 (or P7.1, or greater).</p>

i Note:

- Unless your data source is created by a program, all of the characters are either of type A (alphanumeric) or type Z (zoned decimal).
- ACTUAL formats supported for date-time values are An , H8, H10, and H12. An accepts all the date-time string formats, as well as the Hn USAGE display format. ACTUAL=H8, H10, or H12 accepts a date-time field as it occurs in a binary HOLD file or SAVB file. ACTUAL= An accepts a date-time field as it occurs in an alphanumeric HOLD file or SAVE file.
- If you create a binary HOLD file from a data source with a date-time field, the ACTUAL format for that field is of the form Hn . If you create an alphanumeric HOLD file from a data source with a date-time field, the ACTUAL format for that field is of the form An .

ACTUAL to USAGE Conversion

The following conversions from ACTUAL format to USAGE (display) format are automatically handled and do not require invoking a function:

ACTUAL	USAGE
A	A, D, F, I, P, date format, date-time format
D	D
DATE	date format
F	F

ACTUAL	USAGE
H	H
I	I, date format
M	M
P	P, date format
X	X
Z	D, F, I, P

COBOL Picture to USAGE Format Conversion

The following table shows the USAGE and ACTUAL formats for COBOL, FORTRAN, PL1, and Assembler field descriptions.

COBOL USAGE FORMAT	BYTES OF COBOL PICTURE	INTERNAL STORAGE	ACTUAL FORMAT	USAGE FORMAT
DISPLAY	X(4)	4	A4	A4
DISPLAY	S99	2	Z2	P3
DISPLAY	9(5)V9	6	Z6.1	P8.1
DISPLAY	99	2	A2	A2

COBOL USAGE FORMAT	BYTES OF COBOL PICTURE	INTERNAL STORAGE	ACTUAL FORMAT	USAGE FORMAT
COMP COMP COMP* COMP COMP-1**	S9 S9(4) S9(5) S9(9) —	4 4 4 4 4	I2 I2 I4 I4 F4	I1 I4 I5 I9 F6
COMP-2***	—	8	D8	D15
COMP-3 COMP-3 COMP-3	9 S9V99 9(4)V9(3)	8 8 8	P1 P2 P4	P1 P5.2 P8.3
FIXED BINARY(7) (COMP-4)	B or XL1	8	I4	I7

* Equivalent to INTEGER in FORTRAN, FIXED BINARY(31) in PL/1, and F in Assembler.

** Equivalent to REAL in FORTRAN, FLOAT(6) in PL/1, and E in Assembler.

*** Equivalent to DOUBLE PRECISION or REAL*8 in FORTRAN, FLOAT(16) in PL/1, and D in Assembler.

i Note:

1. The USAGE lengths shown are minimum values. They may be larger if desired. Additional edit options may also be added.
2. In USAGE formats, an extra character position is required for the minus sign if negative values are expected.
3. PICTURE clauses are not permitted for internal floating-point items.
4. USAGE length should allow for the maximum possible number of digits.
5. In USAGE formats, an extra character position is required for the decimal point.

Note that FOCUS data sources do not use the ACTUAL attribute, and instead rely upon the USAGE attribute to specify both how a field is stored and formatted.

Adding a Geographic Role for a Field

When a field represents a geographic location or coordinate, you can identify its correct geographic role using the GEOGRAPHIC_ROLE attribute in the Master File.

GEOGRAPHIC_ROLE Attribute

This attribute specifies the type of location intelligence data represented by the field.

Specify a Geographic Role

```
GEOGRAPHIC_ROLE = georole
```

where:

georole

Is a valid geographic role. Geographic roles can be names, postal codes, ISO (International Organization for Standardization) codes, FIPS (Federal Information Processing Standards) codes, or NUTS (Nomenclature of Territorial Units for Statistics) codes. The following is a list of supported geographic roles.

- ADDRESS_FULL. Full address.
- ADDRESS_LINE. Number and street name.
- CITY. City name.
- CONTINENT. Continent name.
- CONTINENT_ISO2. Continent ISO-3166 code.
- COUNTRY. Country name.
- COUNTRY_FIPS. Country FIPS code.
- COUNTRY_ISO2. Country ISO-3166-2 code.
- COUNTRY_ISO3. Country ISO-3166-3 code.
- GEOMETRY_AREA. Geometry area.
- GEOMETRY_LINE. Geometry line.
- GEOMETRY_POINT. Geometry point.
- LATITUDE. Latitude.
- LONGITUDE. Longitude.
- NUTS0. Country name (NUTS level 0).
- NUTS0_CC. Country code (NUTS level 0).
- NUTS1. Region name (NUTS level 1).
- NUTS1_CC. Region code (NUTS level1).
- NUTS2. Province name (NUTS level 2).
- NUTS2_CC. Province code (NUTS level 2).
- NUTS3. District name (NUTS level 3).
- NUTS3_CC. District code (NUTS level 3).

- `POSTAL_CODE`. Postal code.
- `STATE`. State name.
- `STATE_FIPS`. State FIPS code.
- `STATE_ISO_SUB`. US State ISO subdivision code.
- `USSCITY`. US city name.
- `USCITY_FIPS`. US city FIPS code.
- `USCOUNTY`. US county name.
- `USCOUNTY_FIPS`. US county FIPS code.
- `USSTATE`. US state name.
- `USSTATE_ABBR`. US state abbreviation.
- `USSTATE_FIPS`. US state FIPS code.
- `ZIP3`. US 3-digit postal code.
- `ZIP5`. US 5-digit postal code.

Null or MISSING Values: MISSING

If a segment instance exists but no data has been entered into one of its fields, that field has no value. Some types of data sources represent this absence of data as a blank space () or zero (0), but others explicitly indicate an absence of data with a null indicator or as a special null value. Null values (sometimes known as missing data) are significant in reporting applications, especially those that perform aggregating functions, such as averaging.

If your type of data source supports missing data, as do FOCUS data sources and most relational data sources, then you can use the optional MISSING attribute to enable null values to be entered into and read from a field. MISSING plays a role when you:

- **Create new segment instances.** If no value is supplied for a field for which MISSING has been turned ON in the Master File or in a DEFINE or COMPUTE definition, then the field is assigned a missing value.
- **Generate reports.** If a field with a null value is retrieved, the field value is not used in aggregating calculations, such as averaging and summing. If the report calls for the field value to display, a special character appears to indicate a missing value. The

default character is a period (.), but you can change it to any character string you wish using the SET NODATA command or the SET HNODATA command for HOLD files, as described in the *Developing Applications* manual.

Specify a Missing Value

```
MISSING = {ON|OFF}
```

where:

ON

Distinguishes a missing value from an intentionally entered blank or zero when creating new segment instances and reporting.

OFF

Does not distinguish between missing values and blank or zero values when creating new segment instances and reporting. OFF is the default value.

Usage Notes for MISSING

Note the following rules when using MISSING:

- **Alias.** MISSING does not have an alias.
- **Value.** It is recommended that you set the MISSING attribute to match the field predefined null characteristic (whether the characteristic is explicitly set when the data source is created, or set by default). For example, if a relational table column has been created with the ability to accept null data, describe the field with the MISSING attribute set to ON so that its null values are correctly interpreted.

FOCUS data sources also support MISSING=ON, which assigns sets an internal flag for missing values.

- **Changes.** You can change the MISSING attribute at any time. Note that changing MISSING does not affect the actual stored data values that were entered using the old setting. However, it does affect how that data is interpreted. If null data is entered when MISSING is turned ON, and then MISSING is switched to OFF, the data

originally entered as null is interpreted as blanks (for alphanumeric fields) or zeroes (for numeric fields).

Using a Missing Value

Consider the field values shown in the following four records:

		1	3
--	--	---	---

If you average these values without declaring the field with the MISSING attribute, a value of zero is automatically supplied for the two blank records. Thus, the average of these four records is $(0+0+1+3)/4$, or 1. If you turn MISSING to ON, the two blank records are not used in the calculation, so the average is $(1+3)/2$, or 2.

Missing values in a unique segment are also automatically supplied with a zero, a blank, or a missing value depending on the MISSING attribute. What distinguishes missing values in unique segments from other values is that they are not stored. You do have to supply a MISSING attribute for fields in unique segments on which you want to perform counts or averages.

The *FOCUS® Creating Reports* manual contains a more thorough discussion of using null values (sometimes called missing data) in reports. It includes alternative ways of distinguishing these values in reports, such as using the WHERE phrase with MISSING selection operators, and creating virtual fields using the DEFINE FILE command with the SOME or ALL phrase.

Describing an FML Hierarchy

The Financial Modeling Language (FML) supports dynamic reporting against hierarchical data structures.

You can define the hierarchical relationships between fields in a Master File and automatically display these fields using FML. You can also provide descriptive captions to appear in reports in place of the specified hierarchy field values.

In the Master File, use the PROPERTY=PARENT_OF and REFERENCE=*hierarchyfld* attributes to define the hierarchical relationship between two fields.

The parent and child fields must have the same FORMAT or USAGE, and their relationship should be hierarchical. The formats of the parent and child fields must both be numeric or both alphanumeric.

Specify a Hierarchy Between Fields in a Master File

```
FIELD=parentfield,...,PROPERTY=PARENT_OF, REFERENCE=[seg.]hierarchyfld,$
```

where:

parentfield

Is the parent field in the hierarchy.

PROPERTY=PARENT_OF

Identifies this field as the parent of the referenced field in a hierarchy.

These attributes can be specified on every field. Therefore, multiple hierarchies can be defined in one Master File. However, an individual field can have only one parent. If multiple fields have PARENT_OF attributes for the same hierarchy field, the first parent found by traversing the structure in top-down, left-to-right order is used as the parent.

seg

Is the segment location of the hierarchy field. Required if more than one segment has a field named *hierarchyfield*.

hierarchyfld

Is the child field in the hierarchy.

PARENT_OF is also allowed on a virtual field in the Master File:

```
DEFINE name/fmt=expression;,PROPERTY=PARENT_OF,REFERENCE=hierarchyfld,$
```

Assign Descriptive Captions for Hierarchy Field Values

The following attributes specify a caption for a hierarchy field in a Master File

```
FIELD=captionfield,..., PROPERTY=CAPTION, REFERENCE=[seg.]hierarchyfld,$
```

where:

captionfield

Is the name of the field that contains the descriptive text for the hierarchy field. For example, if the employee ID is the hierarchy field, the last name may be the descriptive text that appears on the report in place of the ID.

PROPERTY=CAPTION

Signifies that this field contains a descriptive caption that appears in place of the hierarchy field values.

A caption can be specified for every field, but an individual field can have only one caption. If multiple fields have CAPTION attributes for the same hierarchy field, the first parent found by traversing the structure in top-down, left-to-right order is used as the caption.

seg

Is the segment location of the hierarchy field. Required if more than one segment has a field named *hierarchyfield*.

hierarchyfld

Is the hierarchy field.

CAPTION is also allowed on a virtual field in the Master File:

```
DEFINE name/format=expression;,PROPERTY=CAPTION,REFERENCE=hierarchyfld,$
```

Defining a Hierarchy in a Master File

The CENTGL Master File contains a chart of accounts hierarchy. The field GL_ACCOUNT_PARENT is the parent field in the hierarchy. The field GL_ACCOUNT is the hierarchy field. The field GL_ACCOUNT_CAPTION can be used as the descriptive caption for the hierarchy field:

```
FILE=CENTGL      ,SUFFIX=FOC
SEGNAME=ACCOUNTS,SEGTYPE=S01
FIELDNAME=GL_ACCOUNT,      ALIAS=GLACCT,  FORMAT=A7,
      TITLE='Ledger,Account', FIELDTYPE=I, $
FIELDNAME=GL_ACCOUNT_PARENT, ALIAS=GLPAR,  FORMAT=A7,
      TITLE=Parent,
      PROPERTY=PARENT_OF, REFERENCE=GL_ACCOUNT, $
FIELDNAME=GL_ACCOUNT_TYPE,  ALIAS=GLTYPE,  FORMAT=A1,
      TITLE=Type,$
FIELDNAME=GL_ROLLUP_OP,     ALIAS=GLROLL,  FORMAT=A1,
      TITLE=Op, $
FIELDNAME=GL_ACCOUNT_LEVEL, ALIAS=GLLEVEL,  FORMAT=I3,
      TITLE=Lev, $
FIELDNAME=GL_ACCOUNT_CAPTION, ALIAS=GLCAP,  FORMAT=A30,
      TITLE=Caption,
      PROPERTY=CAPTION, REFERENCE=GL_ACCOUNT, $
FIELDNAME=SYS_ACCOUNT,     ALIAS=ALINE,  FORMAT=A6,
      TITLE='System,Account,Line', MISSING=ON, $
```

Validating Data: ACCEPT

ACCEPT is an optional attribute that you can use to validate data as it is entered into a field from a MODIFY or FSCAN procedure.

The ACCEPT test is applied immediately after a FIXFORM CRTFORM, PROMPT, FIXFORM, or FREEFORM is processed after which subsequent COMPUTE statements can manipulate the value. By including ACCEPT in a field declaration, you can define a list or range of acceptable field values. In relational terms, you are defining the domain.

The ACCEPT attribute supports the following types of operations:

- ACCEPT = *value1* OR *value2* ...
This option is used to specify one or more acceptable values.
- ACCEPT = *value1* TO *value2*

This option is used to specify a range of acceptable values.

- ACCEPT = FIND

This option is used to validate incoming transaction data against a value from a FOCUS data source when performing maintenance operations on another data source. FIND is only supported for FOCUS data sources and does not apply to OLAP-enabled synonyms. Note also that, in the Maintain environment, FIND is not supported when developing a synonym.

- ACCEPT = DECODE

This option is used to supply pairs of values for auto amper-prompting. Each pair consists of one value that can be looked up in the data source and a corresponding value for display.

- ACCEPT = FOCEXEC

This option is used to retrieve lookup and display field values by running a FOCEXEC. Each row in the output must include one value for lookup and a corresponding value for display. These values can be anywhere in the row, in any order. The FOCEXEC can return other columns as well.

- ACCEPT = SYNONYM

This option is used to look up values in another data source and retrieve a corresponding display value. The lookup field values must exist in both data sources, although they do not need to have matching field names. You supply the name of the synonym, the lookup field name, and the display field name.

Validate Data

```
ACCEPT = list
```

```
ACCEPT = value1 TO value2
```

```
ACCEPT = FIND (field [AS name] IN file)
```

```
ACCEPT=SYNONYM(lookup_field AS display_field IN lookup_synonym)
```

```
ACCEPT=FOCEXEC(lookup_field AS display_field IN lookup_focexec)
```

where:

list

Is a string of acceptable values. The syntax is:

```
value1 OR value2 OR value3...
```

For example, ACCEPT = RED OR WHITE OR BLUE. You can also use a blank as an item separator. If the list of acceptable values runs longer than one line, continue it on the next. The list is terminated by a comma.

value1 TO value2

Gives the range of acceptable values. For example, ACCEPT = 150 TO 1000.

FIND

Verifies the incoming data against the values in another indexed field. This option is available only in MODIFY procedures for FOCUS data sources.

SYNONYM

Looks up values in another data source and retrieves a corresponding display value. The lookup field values must exist in both data sources, although they do not need to have matching field names. You supply the name of the synonym, the lookup field name and the display field name.

FOCEXEC

Retrieves lookup and corresponding display values by running a FOCEXEC. Each row must return a lookup field value and its corresponding display field value anywhere in the row, in any order. You supply the name of the FOCEXEC, the lookup field name, and the display field name.

lookup_field

Is the field in the lookup_synonym or returned by the lookup_focexec whose value will be used in the filter (WHERE dialogue) or by the amper autoprompt facility that will be compared with the field that has the ACCEPT attribute.

display_field

Is the field in the lookup_synonym or returned by the lookup_focexec, whose value will be displayed for selection in the filter dialogue or amper autoprompt drop-down list.

lookup_synonym

Is the name of the synonym that describes the lookup data.

lookup_focexec

Is the name of the FOCEXEC that returns the lookup and display field values, in any order. This FOCEXEC can return other field values as well.

Any value in the ACCEPT that contains an embedded blank (for example, Great Britain) must be enclosed within single quotation marks.

If the ACCEPT attribute is included in a field declaration and the SET command parameter ACCBLN has a value of OFF, blank () and zero (0) values are accepted only if they are explicitly coded into the ACCEPT. SET ACCBLN is described in the *Developing Applications* manual.

Specifying a List With an Embedded Blank

```
ACCEPT = SPAIN OR ITALY OR FRANCE OR 'GREAT BRITAIN'
```

Usage Notes for ACCEPT

Note the following rules when using ACCEPT:

- **Alias.** ACCEPT does not have an alias.
- **Changes.** You can change the information in an ACCEPT attribute at any time.
- **Virtual fields.** You cannot use the ACCEPT attribute to validate virtual fields created with the DEFINE attribute.
- **HOLD files.** If you wish to propagate the ACCEPT attribute into the Master File of a HOLD file, use the SET HOLDATTR command. HOLD files are discussed in the *FOCUS® Creating Reports* manual. **ACCEPT=FOUND** is used only in MODIFY procedures. It is

useful for providing one central validation list to be used by several procedures. The FIND function is useful when the list of values is large or undergoes frequent change.

- **The HELPMESSAGE attribute** defines a message to display based on the results of an ACCEPT test.

Alternative Report Column Titles: TITLE

When you generate a report, each column title in the report defaults to the name of the field that appears in that column. However, you can change the default column title by specifying the optional TITLE attribute for that field.

You can also specify a different column title within an individual report by using the AS phrase in that report request, as described in the *FOCUS® Creating Reports* manual.

Note that the TITLE attribute has no effect in a report if the field is used with a prefix operator, such as AVE. You can supply an alternative column title for fields used with prefix operators by using the AS phrase.

Master Files support TITLE attributes for multiple languages. For more information, see [Multilingual Metadata](#).

Specify an Alternative Title

```
TITLE = 'text'
```

where:

text

Is any string of up to 512 characters, in a single-byte character set. If you are working in a Unicode environment, this length will be affected by the number of bytes used to represent each character, as described in the chapter named *Unicode Support* in the *FOCUS® Overview and Operating Environments* manual. You can split the text across as many as five separate title lines by separating the lines with a comma (,). Include blanks at the end of a column title by including a slash (/) in the final blank position. You must enclose the string within single quotation marks if it includes commas or leading blanks.

Replacing the Default Column Title

The following FIELD declaration:

```
FIELD = LNAME, ALIAS = LN, USAGE = A15, TITLE = 'Client,Name', $
```

replaces the default column heading, LNAME, with the following:

```
Client
Name
-----
```

Usage Notes for TITLE

Note the following rules when using TITLE:

- **Alias.** TITLE does not have an alias.
- **Changes.** You can change the information in TITLE at any time. You can also override the TITLE with an AS name in a request, or turn it off with the SET TITLES=OFF command.
- **Virtual fields.** If you use the TITLE attribute for a virtual field created with the DEFINE attribute, the semicolon (;) terminating the DEFINE expression must be on the same line as the TITLE keyword.
- **HOLD files.** To propagate the TITLE attribute into the Master File of a HOLD file, use the SET HOLDATTR command. HOLD files are discussed in the *FOCUS® Creating Reports* manual.

Documenting the Field: DESCRIPTION

DESCRIPTION is an optional attribute that enables you to provide comments and other documentation for a field within the Master File. You can include any comment up to 2K (2048) characters in length.

Note that you can also add documentation to a field declaration, or to a segment or file declaration, by typing a comment in the columns following the terminating dollar sign. You

can even create an entire comment line by inserting a new line following a declaration and placing a dollar sign at the beginning of the line.

The DESCRIPTION attribute for a FOCUS data source can be changed at any time without rebuilding the data source.

Master Files support description attributes for multiple languages. For more information, see [Multilingual Metadata](#).

Supply Field Documentation

```
DESC[RIPTION] = text
```

where:

DESCRIPTION

Can be shortened to DESC. Abbreviating the keyword has no effect on its function.

text

Is any string of up to 2K (2048) characters. If it contains a comma, the string must be enclosed within single quotation marks.

Specifying a DESCRIPTION

The following FIELD declaration provides a DESCRIPTION:

```
FIELD=UNITS,ALIAS=QTY,USAGE=I6, DESC='QUANTITY SOLD, NOT RETURNED', $
```

Usage Notes for DESCRIPTION

Note the following rules when using the DESCRIPTION attribute:

- **Alias.** The DESCRIPTION attribute has an alias of DEFINITION.
- **Changes.** You can change DESCRIPTION at any time.

- **Virtual fields.** You can use the DESCRIPTION attribute for a virtual field created with the DEFINE attribute.

Multilingual Metadata

Master Files support column headings and descriptions in multiple languages.

The heading or description used depends on the value of the LANG parameter and whether a TITLE_*ln* or DESC_*ln* attribute is specified in the Master File, or a set of translation files exist for the Master File, where *ln* identifies the language to which the column heading or description applies.

In a Master File, column headings are taken from:

1. A heading specified in the report request using the AS phrase.
2. A TITLE attribute in the Master File, if no AS phrase is specified in the request and SET TITLES=ON.
3. The field name specified in the Master File, if no AS phrase or TITLE attribute is specified, or if SET TITLES=OFF.

Activate the Use of a Language

Issue the following command in a supported profile, on the command line, or in a FOCEXEC:

```
SET LANG = lng
```

or

```
SET LANG = ln
```

where:

lng

Is the three-letter abbreviation for the language.

ln

Is the two-letter ISO language code.

i Note: If SET LANG is used in a procedure, its value will override the values set in nlscfg.err or in any profile.

Activating a Language in the NLS Configuration File

In the NLSCGF ERRORS configuration file, issue the following command:

```
LANG = lng
```

Languages and Language Code Abbreviations

Language Name	Two-Letter Language Code	Three-Letter Language Abbreviation
Arabic	ar	ARB
Baltic	lt	BAL
Chinese - Simplified GB	zh	PRC
Chinese - Traditional Big-5	tw	ROC
Czech	cs	CZE
Danish	da	DAN

Language Name	Two-Letter Language Code	Three-Letter Language Abbreviation
Dutch	nl	DUT
English - American	en	AME or ENG
English - UK	uk	UKE
Finnish	fi	FIN
French - Canadian	fc	FRE
French - Standard	fr	FRE
German - Austrian	at	GER
German - Standard	de	GER
Greek	el	GRE
Hebrew	iw	HEW
Italian	it	ITA
Japanese - Shift-JIS(cp942) on ascii cp939 on EBCDIC	ja	JPN
Japanese - EUC(cp10942) on ascii (UNIX)	je	JPE
Korean	ko	KOR
Norwegian	no	NOR
Polish	pl	POL
Portuguese - Brazilian	br	POR

Language Name	Two-Letter Language Code	Three-Letter Language Abbreviation
Portuguese - Portugal	pt	POR
Russian	ru	RUS
Spanish	es	SPA
Swedish	sv	SWE
Thai	th	THA
Turkish	tr	TUR

Placing Multilingual Metadata Directly in a Master File

You can place `TITLE_`*ln* and `DESCRIPTION_`*ln* attributes directly in the Master file, where *ln* specifies the language code.

i **Note:** You can also create a set of language translation files and include the `trans_file` attribute at the file level of the Master File. For information on this technique, see [Storing Localized Metadata in Language Files](#).

Specify Multilingual Metadata in a Master File

```
FIELDNAME = field, ...
.
.
TITLE= default_column_heading, TITLE_
```



```

.
.
.
DESC= default_desc, DESC_ln = desc_for_ln,
.
.
.

```

where:

field

Is a field in the Master File.

default_column_heading

Is the column heading to use when SET TITLES=ON and either the LANG parameter is set to the default language for FOCUS, or another language is set but the Master File has no corresponding TITLE_*ln* attribute for that field. This column heading is also used if the *ln* value is invalid.

default_desc

Is the description to use when either the LANG parameter is set to the default language for FOCUS, or another language is set but the Master File has no corresponding DESC_*ln* attribute for that field. This description is also used if the *ln* value is invalid.

TITLE_ln = column_heading_for_ln

Specifies the language for which the column heading applies and the text of the column heading in that language. That column heading is used when SET TITLES=ON, the LANG parameter is set to a non-default language for FOCUS, and the Master File has a corresponding TITLE_*ln* attribute, where *ln* is the two-digit code for the language specified by the LANG parameter. Valid values for *ln* are the two-letter ISO 639 language code abbreviations. For more information, see [Languages and Language Code Abbreviations](#).

DESC_ln = desc_for_ln

Specifies the language for which the description applies and the description text in that language. This description is used when the LANG parameter is set to a non-default language for FOCUS and the Master File has a corresponding DESC_*ln* attribute. Valid values for *ln* are the two-letter ISO 639 language code abbreviations.

Usage Notes for Multilingual Metadata

- To generate the correct characters, all languages used must be on the code page specified at startup.
- Master Files should be stored using the code page used by FOCUS.
- Multilingual descriptions are supported with all fields described in the Master File, including DEFINE and COMPUTE fields.
- The user must create the NLSCFG file. The NLSCFG file must be a member in the concatenation of data sets allocated to DDNAME ERRORS.
- If you issue a HOLD command with SET HOLDATTR=ON, only one TITLE attribute is propagated to the HOLD Master File. Its value is the column heading that would have appeared on the report output.
- After it is referenced in a request, the Master File is stored in memory. If you want to produce a report against the same Master File but generate column titles in a different language, you must make sure the Master File is re-read after you issue the SET LANG command and prior to running the request. You can make sure the Master File is re-read by issuing a CHECK FILE command for that Master File.

Using Multilingual Descriptions in a Master File

The following Master File for the CENTINV data source specifies French descriptions (DESC_FR) and Spanish descriptions (DESC_ES) as well as default descriptions (DESC) for the PROD_NUM and PRODDNAME fields:

```
FILE=CENTINV, SUFFIX=FOC, FDFC=19, FYRT=00
SEGNAME=INVINFO, SEGTYPE=S1, $
FIELD=PROD_NUM, ALIAS=PNUM, FORMAT=A4, INDEX=I,
  DESCRIPTION='Product Number'
DESC='Product Number',
DESC_ES='Numero de Producto',
DESC_FR='Nombre de Produit', $
FIELD=PRODDNAME, ALIAS=PNAME, FORMAT=A30,
WITHIN=PRODCAT,
DESCRIPTION='Product Name'
DESC_FR='Nom de Produit',
DESC_ES='Nombre de Producto', $
```

```

FIELD=QTY_IN_STOCK, ALIAS=QIS, FORMAT=I7,
DESCRIPTION='Quantity In Stock', $
FIELD=PRICE, ALIAS=RETAIL, FORMAT=D10.2,
TITLE='Price:',
DESCRIPTION=Price, $

```

Using Multilingual Titles in a Request

The following Master File for the CENTINV data source specifies French titles (TITLE_FR) and Spanish titles (TITLE_ES) as well as default titles (TITLE) for the PROD_NUM and PRODNAME fields:

```

FILE=CENTINV, SUFFIX=FOC, FDFC=19, FYRT=00
SEGNAME=INVINFO, SEGTYPE=S1, $
FIELD=PROD_NUM, ALIAS=PNUM, FORMAT=A4, INDEX=I,
TITLE='Product,Number:',
TITLE_FR='Nombre,de Produit:',
TITLE_ES='Numero,de Producto:',
DESCRIPTION='Product Number', $
FIELD=PRODNAME, ALIAS=PNAME, FORMAT=A30,
WITHIN=PRODCAT,
TITLE='Product,Name:',
TITLE_FR='Nom,de Produit:',
TITLE_ES='Nombre,de Producto:'
DESCRIPTION='Product Name', $
FIELD=QTY_IN_STOCK, ALIAS=QIS, FORMAT=I7,
TITLE='Quantity,In Stock:',
DESCRIPTION='Quantity In Stock', $
FIELD=PRICE, ALIAS=RETAIL, FORMAT=D10.2,
TITLE='Price:',
DESCRIPTION=Price, $

```

The default language is English and, by default, SET TITLES=ON. Therefore, the following request, uses the TITLE attributes to produce column headings that are all in English:

```

TABLE FILE CENTINV
PRINT PROD_NUM PRODNAME PRICE
WHERE PRICE LT 200
END

```

The output is:

Product Number:	Product Name:	Price:
-----	-----	-----
1004	2 Hd VCR LCD Menu	179.00
1008	DVD Upgrade Unit for Cent. VCR	199.00
1026	AR3 35MM Camera 10 X	129.00
1028	AR2 35MM Camera 8 X	109.00
1030	QX Portable CD Player	169.00
1032	R5 Micro Digital Tape Recorder	89.00

Now, issue the following command to set the language to Spanish and run the same request:

```
SET LANG = SPA
```

Issue the CHECK FILE CENTINV command to re-read the Master File, and rerun the request.

The output now displays column headings from the TITLE_ES attributes where they exist (Product Number and Product Name). Where no Spanish title is specified (the Price field), the column heading in the TITLE attribute appears:

Numero de Producto:	Nombre de Producto:	Price:
-----	-----	-----
1004	2 Hd VCR LCD Menu	179.00
1008	DVD Upgrade Unit for Cent. VCR	199.00
1026	AR3 35MM Camera 10 X	129.00
1028	AR2 35MM Camera 8 X	109.00
1030	QX Portable CD Player	169.00
1032	R5 Micro Digital Tape Recorder	89.00

Describing a Virtual Field: DEFINE

DEFINE is an optional attribute used to create a virtual field for reporting. You can derive the virtual field value from information already in the data source (that is, from permanent fields). Some common uses of virtual data fields include:

- Computing new numeric values that are not on the data record.
- Computing a new string of alphanumeric characters from other strings.

- Classifying data values into ranges or groups.
- Invoking subroutines in calculations.

Virtual fields are available whenever the data source is used for reporting.

Define a Virtual Field

```
DEFINE fieldname/format [(GEOGRAPHIC_ROLE = georole)]  
  [REDEFINES field2] = expression;  
  [,TITLE='title',]  
  [TITLE_ln='title\n', ... ,]  
  [,DESC[CRPTION]='desc',]  
  [DESC_ln='desc\n', ... ,]$\
```

where:

fieldname

Is the name of the virtual field. The name is subject to the same conventions as names assigned using the FIELDNAME attribute. FIELDNAME is described in [The Field Name: FIELDNAME](#).

format

Is the field format. It is specified in the same way as formats assigned using the USAGE attribute, which is described in [The Displayed Data Type: USAGE](#). If you do not specify a format, it defaults to D12.2.

georole

Is a valid geographic role. Geographic roles can be names, postal codes, ISO (International Organization for Standardization) codes, FIPS (Federal Information Processing Standards) codes, or NUTS (Nomenclature of Territorial Units for Statistics) codes. The following is a list of supported geographic roles.

- ADDRESS_FULL. Full address.
- ADDRESS_LINE. Number and street name.
- CITY. City name.

- CONTINENT. Continent name.
- CONTINENT_ISO2. Continent ISO-3166 code.
- COUNTRY. Country name.
- COUNTRY_FIPS. Country FIPS code.
- COUNTRY_ISO2. Country ISO-3166-2 code.
- COUNTRY_ISO3. Country ISO-3166-3 code.
- GEOMETRY_AREA. Geometry area.
- GEOMETRY_LINE. Geometry line.
- GEOMETRY_POINT. Geometry point.
- LATITUDE. Latitude.
- LONGITUDE. Longitude.
- NUTS0. Country name (NUTS level 0).
- NUTS0_CC. Country code (NUTS level 0).
- NUTS1. Region name (NUTS level 1).
- NUTS1_CC. Region code (NUTS level 1).
- NUTS2. Province name (NUTS level 2).
- NUTS2_CC. Province code (NUTS level 2).
- NUTS3. District name (NUTS level 3).
- NUTS3_CC. District code (NUTS level 3).
- POSTAL_CODE. Postal code.
- STATE. State name.
- STATE_FIPS. State FIPS code.
- STATE_ISO_SUB. US State ISO subdivision code.
- USSCITY. US city name.
- USCITY_FIPS. US city FIPS code.

- USCOUNTY. US county name.
- USCOUNTY_FIPS. US county FIPS code.
- USSTATE. US state name.
- USSTATE_ABBR. US state abbreviation.
- USSTATE_FIPS. US state FIPS code.
- ZIP3. US 3-digit postal code.
- ZIP5. US 5-digit postal code.

field2

Enables you to redefine or recompute a field whose name exists in more than one segment.

expression

Is a valid expression. The expression must end with a semicolon (;). Expressions are fully described in the *FOCUS® Creating Reports* manual.

Note that when an IF-THEN phrase is used in the expression of a virtual field, it must include the ELSE phrase.

TITLE='title'

Is a column title for the virtual field in the default language.

TITLE_ln='titleln'

Is a column title for the virtual field in the language specified by the language code **ln**.

DESC[CRPTION]='desc'

Is a description for the virtual field in the default language.

DESC_ln='descln'

Is a description for the virtual field in the language specified by the language code **ln**.

Place each DEFINE attribute after all of the field descriptions for that segment.

Defining a Field

The following shows how to define a field called PROFIT in the segment CARS:

```
SEGMENT = CARS ,SEGTYPE = S1 ,PARENT = CARREC, $  
FIELDNAME = DEALER_COST ,ALIAS = DCOST ,USAGE = D7, $  
FIELDNAME = RETAIL_COST ,ALIAS = RCOST ,USAGE = D7, $  
DEFINE PROFIT/D7 = RETAIL_COST - DEALER_COST; $
```

Usage Notes for Virtual Fields in a Master File

Note the following rules when using DEFINE:

- **Alias.** DEFINE does not have an alias.
- **Changes.** You can change the virtual field declaration at any time.
- A DEFINE FILE command takes precedence over a DEFINE in the Master with the same name.
- If the expression used to derive the virtual field invokes a function, parameter numbers and types are not checked unless the USERFCHK parameter is set to FULL.

Using a Virtual Field

A DEFINE attribute cannot contain qualified field names on the left-hand side of the expression. Use the WITH phrase on the left-hand side to place the defined field in the same segment as any real field you choose. This will determine when the DEFINE expression will be evaluated.

Expressions on the right-hand side of the DEFINE can refer to fields from any segment in the same path. The expression on the right-hand side of a DEFINE statement in a Master File can contain qualified field names.

A DEFINE attribute in a Master File can refer to only fields in its own path. If you want to create a virtual field that derives its value from fields in several different paths, you have to create it with a DEFINE FILE command using an alternate view prior to a report request, as discussed in the *FOCUS® Creating Reports* manual. The DEFINE FILE command is also helpful when you wish to create a virtual field that is only used once, and you do not want to add a declaration for it to the Master File.

Virtual fields defined in the Master File are available whenever the data source is used, and are treated like other stored fields. Thus, a field defined in the Master File cannot be cleared in your report request.

A virtual field cannot be used for cross-referencing in a join. It can, however, be used as a host field in a join.

**Note:**

Maintain Data does not support DEFINE attributes that have a constant value. Using such a field in a Maintain Data procedure generates the following message:

```
(FOC03605) name is not recognized.
```

Describing a Calculated Value: COMPUTE

COMPUTE commands can be included in Master Files and referenced in subsequent TABLE requests, enabling you to build expressions once and use them in multiple requests.

Include a COMPUTE Command in a Master File

```
COMPUTE fieldname/fmt [(GEOGRAPHIC_ROLE = georole)]
=expression;
[,TITLE='title',]
[TITLE_ln='title\n', ... ,]
[,DESC[CRPTION]='desc',]
[DESC_ln='desc\n', ... ,]$
```

where:

fieldname

Is name of the calculated field.

fmt

Is the format and length of the calculated field.

georole

Is a valid geographic role. Geographic roles can be names, postal codes, ISO (International Organization for Standardization) codes, FIPS (Federal Information Processing Standards) codes, or NUTS (Nomenclature of Territorial Units for Statistics) codes. The following is a list of supported geographic roles.

- ADDRESS_FULL. Full address.
- ADDRESS_LINE. Number and street name.
- CITY. City name.
- CONTINENT. Continent name.
- CONTINENT_ISO2. Continent ISO-3166 code.
- COUNTRY. Country name.
- COUNTRY_FIPS. Country FIPS code.
- COUNTRY_ISO2. Country ISO-3166-2 code.
- COUNTRY_ISO3. Country ISO-3166-3 code.
- GEOMETRY_AREA. Geometry area.
- GEOMETRY_LINE. Geometry line.
- GEOMETRY_POINT. Geometry point.
- LATITUDE. Latitude.
- LONGITUDE. Longitude.
- NUTS0. Country name (NUTS level 0).
- NUTS0_CC. Country code (NUTS level 0).
- NUTS1. Region name (NUTS level 1).
- NUTS1_CC. Region code (NUTS level1).
- NUTS2. Province name (NUTS level 2).
- NUTS2_CC. Province code (NUTS level 2).
- NUTS3. District name (NUTS level 3).
- NUTS3_CC. District code (NUTS level 3).

- `POSTAL_CODE`. Postal code.
- `STATE`. State name.
- `STATE_FIPS`. State FIPS code.
- `STATE_ISO_SUB`. US State ISO subdivision code.
- `USSCITY`. US city name.
- `USCITY_FIPS`. US city FIPS code.
- `USCOUNTY`. US county name.
- `USCOUNTY_FIPS`. US county FIPS code.
- `USSTATE`. US state name.
- `USSTATE_ABBR`. US state abbreviation.
- `USSTATE_FIPS`. US state FIPS code.
- `ZIP3`. US 3-digit postal code.
- `ZIP5`. US 5-digit postal code.

expression

Is the formula for calculating the value of the field.

TITLE='title'

Is a column title for the calculated field in the default language.

TITLE_ln='titleln'

Is a column title for the calculated field in the language specified by the language code **ln**.

DESC[CRPTION]='desc'

Is a description for the calculated field in the default language.

DESC_ln='descln'

Is a description for the calculated field in the language specified by the language code **ln**.

Usage Notes for COMPUTE in a Master File

In all instances, COMPUTEs in the Master File have the same functionality and limitations as temporary COMPUTEs. Specifically, fields computed in the Master File must follow these rules:

- They cannot be used in JOIN, DEFINE, or ACROSS phrases, or with prefix operators.
- When used as selection criteria, the syntax is either IF TOTAL field or WHERE TOTAL field.
- When used as sort fields, the syntax is BY TOTAL COMPUTE field.
- To insert a calculated value into a heading or footing, you must reference it prior to the HEADING or FOOTING command.

Note: Maintain Data does not currently support using COMPUTEs in Master Files.

Coding a COMPUTE in the Master File and Accessing the Computed Value

Use standard COMPUTE syntax to add a calculated value to your Master File. You can then access the calculated value by referencing the computed fieldname in subsequent TABLE requests. When used as a verb object, as in the following example, the syntax is SUM (or PRINT) COMPUTE field.

The following is the SALESTES Master File (the SALES FILE modified with an embedded COMPUTE):

```
FILENAME=SALESTES, SUFFIX=FOC,
SEGNAME=STOR_SEG, SEGTYPE=S1,
  FIELDNAME=STORE_CODE, ALIAS=SNO, FORMAT=A3, $
  FIELDNAME=CITY, ALIAS=CTY, FORMAT=A15, $
  FIELDNAME=AREA, ALIAS=LOC, FORMAT=A1, $

SEGNAME=DATE_SEG, PARENT=STOR_SEG, SEGTYPE=SH1,
  FIELDNAME=DATE, ALIAS=DTE, FORMAT=A4MD, $

SEGNAME=PRODUCT, PARENT=DATE_SEG, SEGTYPE=S1,
  FIELDNAME=PROD_CODE, ALIAS=PCODE, FORMAT=A3, FIELDTYPE=I, $
```

```

FIELDNAME=UNIT_SOLD,      ALIAS=SOLD,      FORMAT=I5,      $
FIELDNAME=RETAIL_PRICE,  ALIAS=RP,        FORMAT=D5.2M,   $
FIELDNAME=DELIVER_AMT,   ALIAS=SHIP,      FORMAT=I5,      $
FIELDNAME=OPENING_AMT,   ALIAS=INV,        FORMAT=I5,      $
FIELDNAME=RETURNS,       ALIAS=RTN,        FORMAT=I3,      MISSING=ON, $
FIELDNAME=DAMAGED,       ALIAS=BAD,        FORMAT=I3,      MISSING=ON, $

COMPUTE REVENUE/D12.2M=UNIT_SOLD*RETAIL_PRICE;

```

The following TABLE request uses the REVENUE field:

```

TABLE FILE SALESTES
HEADING CENTER
"NEW YORK PROFIT REPORT"
" "
SUM UNIT_SOLD AS 'UNITS,SOLD' RETAIL_PRICE AS 'RETAIL_PRICE'
COMPUTE REVENUE;
BY PROD_CODE AS 'PROD,CODE'
WHERE CITY EQ 'NEW YORK'
END

```

The output is:

```

                NEW YORK PROFIT REPORT

PROD  UNITS
CODE  SOLD  RETAIL_PRICE      REVENUE
----  ----  -
B10   30     $ .85             $25.50
B17   20     $1.89             $37.80
B20   15     $1.99             $29.85
C17   12     $2.09             $25.08
D12   20     $2.09             $41.80
E1    30     $ .89             $26.70
E3    35     $1.09             $38.15

```

Describing a Filter: FILTER

Boolean virtual fields (DEFINE fields that evaluate to TRUE or FALSE) can be used as record selection criteria. If the primary purpose of a virtual field is for use in record selection, you can clarify this purpose and organize virtual fields in the Master File by storing the

expression using a FILTER declaration rather than a DEFINE. Filters offer the following features:

- They allow you to organize and store popular selection criteria in a Master File, group them in a Business View, and reuse them in multiple requests and tools.
- For some data sources (such as VSAM and ISAM), certain filter expressions can be inserted inline into the WHERE or IF clause, enhancing optimization compared to a Boolean DEFINE.

Declare a Filter in a Master File

```
FILTER filtername = expression; [MANDATORY={YES|NO}]
[, DESC[RIPTION]='desc']
[, DESC_ln='desc\n', ... ] , $
```

where:

filtername

Is the name assigned to the filter. The filter is internally assigned a format of I1, which cannot be changed.

expression

Is a logical expression that evaluates to TRUE (which assigns the value 1 to the filter field) or FALSE (which assigns the value 0 to the filter field). For any other type of expression, the field becomes a standard numeric virtual field in the Master File. Dialogue Manager variables (amper variables) can be used in the filter expression in the same way they are used in standard Master File DEFINES.

MANDATORY={YES|NO}

Specifies whether to apply the filter even if it is not referenced in a request against the synonym. YES applies the filter to all requests against the synonym. NO applies the filter only when it is referenced in a request. NO is the default value.

i Note: Unlike a filter created using the FILTER FILE command, which can be toggled ON and OFF, this setting can only be turned off by removing or changing the value in the Master File.

DESC[RIPTION]='desc'

Is a description for the sort object in the default language.

DESC_In='descln'

Is a description for the sort object in the language specified by the language code **ln**.

Use a Master File Filter in a Request

```
TABLE FILE filename
.
.
.
{WHERE|IF} expression_using_filters
```

where:

expression_using_filters

Is a logical expression that references a filter. In a WHERE phrase, the logical expression can reference one or more filters and/or virtual fields.

Usage Notes for Filters in a Master File

- The filter field name is internally assigned a format of I1 which cannot be changed.
- A filter can be used as a standard numeric virtual field anywhere in a report request, except that they are not supported in WHERE TOTAL tests.
- A mandatory filter can be used to force access to a segment (for example, a table in a cluster synonym) that is not referenced in a request.

Defining and Using a Master File Filter

Consider the following filter declaration added to the MOVIES Master File:

```
FILTER G_RATING = RATING EQ 'G' OR 'PG'; $
```

The following request applies the G_RATING filter:

```
TABLE FILE MOVIES
HEADING CENTER
"Rating G and PG"
PRINT TITLE CATEGORY RATING
WHERE G_RATING
ON TABLE SET PAGE NOPAGE
ON TABLE SET GRID OFF
ON TABLE HOLD FORMAT HTML
ON TABLE SET STYLE *
type=report, style=bold, color=black, bgcolor=yellow, $
type=data, bgcolor=aqua, $
ENDSTYLE
END
```

The output is shown in the following image:

Rating G and PG		
TITLE	CATEGORY	RATING
JAWS	ACTION	PG
CABARET	MUSICALS	PG
BABETTE'S FEAST	FOREIGN	G
SHAGGY DOG, THE	CHILDREN	G
REAR WINDOW	MYSTERY	PG
VERTIGO	MYSTERY	PG
BACK TO THE FUTURE	COMEDY	PG
GONE WITH THE WIND	CLASSIC	G
AIRPLANE	COMEDY	PG
ALICE IN WONDERLAND	CHILDREN	G
ANNIE HALL	COMEDY	PG
FIDDLER ON THE ROOF	MUSICALS	G
BIG	COMEDY	PG
TOP GUN	ACTION	PG
FAMILY, THE	FOREIGN	PG
BAMBI	CHILDREN	G
DEATH IN VENICE	FOREIGN	PG

Using a Mandatory Filter

Consider the following filter declaration added to the MOVIES Master File:

```
FILTER G_RATING = RATING EQ 'G' OR 'PG'; MANDATORY=YES , $
```

The following request does not reference the G_RATING filter:

```
TABLE FILE MOVIES
HEADING CENTER
"Rating G and PG"
PRINT TITLE CATEGORY RATING
ON TABLE SET PAGE NOPAGE
ON TABLE SET GRID OFF
ON TABLE HOLD FORMAT HTML
```

```
ON TABLE SET STYLE *
type=report, style=bold, color=black, bgcolor=yellow, $
type=data, bgcolor=aqua, $
ENDSTYLE
END
```

The output is shown in the following image. Note that the G_RATING filter is applied even though it is not referenced in the request:

Rating G and PG		
TITLE	CATEGORY	RATING
JAWS	ACTION	PG
CABARET	MUSICALS	PG
BABETTE'S FEAST	FOREIGN	G
SHAGGY DOG, THE	CHILDREN	G
REAR WINDOW	MYSTERY	PG
VERTIGO	MYSTERY	PG
BACK TO THE FUTURE	COMEDY	PG
GONE WITH THE WIND	CLASSIC	G
AIRPLANE	COMEDY	PG
ALICE IN WONDERLAND	CHILDREN	G
ANNIE HALL	COMEDY	PG
FIDDLER ON THE ROOF	MUSICALS	G
BIG	COMEDY	PG
TOP GUN	ACTION	PG
FAMILY, THE	FOREIGN	PG
BAMBI	CHILDREN	G
DEATH IN VENICE	FOREIGN	PG

Describing a Sort Object: SORTOBJ

You can define sort phrases and attributes in a Master File and reference them by name in a request against the Master File. The entire text of the sort object is substituted at the point in the TABLE where the sort object is referenced. The sort phrases in the sort object

are not verified prior to this substitution. The only verification is that there is a sort object name and an equal sign in the Master File SORTOBJ record.

Usage Notes for Sort Objects in a Master File

- The sort object declaration can appear anywhere after the first SEGNAME/SEGMENT record. However, it must appear after all fields mentioned by it in the Master File, including virtual fields.
- A sort object can use both Master File and local virtual fields.
- Unlimited sort object declarations may appear in a Master File, but the number referenced by a TABLE request cannot result in more than the maximum number of sort phrases in the request.
- The sort object declaration can be followed by optional attributes.
- If a sort object has the same name as a field, the sort object will be used when referenced in a request.

Declare a Sort Object in a Master File

```
FILE= ...
SEG= ...
FIELD= ...
SORTOBJ sortname = {BY|ACROSS} sortfield1 [attributes]
  [{BY|ACROSS} sortfield2 ... ];
  [,DESC[CRPTION]='desc',]
  [DESC_ln='descln', ... ,]$
```

where:

sortname

Is a name for the sort object.

sortfield1, sortfield2 ..

Are fields from the Master File or local DEFINE fields that will be used to sort the report output.

attributes

Are any valid sort attributes.

;

Is required syntax for delimiting the end of the sort object expression.

DESC[CRPTION]='desc'

Is a description for the sort object in the default language.

DESC_In='descln'

Is a description for the sort object in the language specified by the language code **ln**.

Reference a Sort Object in a Request

```
TABLE FILE ...
.
.
.
BY sortname .
.
.
END
```

where:

sortname

Is the sort object to be inserted into the request.

Declaring and Referencing a Sort Object

The following sort object for the GGSALES Master File is named CRSORT. It defines two sort phrases:

- BY the REGION field, with a SKIP-LINE attribute.
- ACROSS the CATEGORY field.

```
SORTOBJ CRSORT = ACROSS CATEGORY BY REGION SKIP-LINE ; , $
```

The following request references the CRSORT sort object:

```
TABLE FILE GGSales
SUM DOLLARS
BY CRSORT
ON TABLE SET PAGE NOPAGE
END
```

The output is:

Region	Category		
	Coffee	Food	Gifts
Midwest	4178513	4404483	2931349
Northeast	4201057	4445197	2848289
Southeast	4435134	4308731	3037420
West	4493483	4204333	2977092

Calling a DEFINE FUNCTION in a Master File

You can reference a DEFINE FUNCTION in an expression in a Master File DEFINE, COMPUTE, or FILTER field. The DEFINE FUNCTION will be loaded into memory when its associated expression is used in a request.

Note: A DEFINE FUNCTION cannot be used in a multi-root Master File.

Call a DEFINE FUNCTION in a Master File Expression

```
DF.[apiname/]filename.functionname(parm1, parm2, ...);
[DESCRIPTION='description', $
```

where:

appname

Is an optional application name under which the DEFINE FUNCTION FOCEXEC is stored.

filename

Is the name of the FOCEXEC that contains the DEFINE FUNCTION definition. The FOCEXEC can contain multiple DEFINE FUNCTION definitions.

functionname(parm1, parm2, ...)

Is the function name with the parameters to be used in the expression.

'description'

Is an optional description enclosed in single quotation marks.

Using a DEFINE FUNCTION in a Master File

The following DEFINE FUNCTION is stored in the DMFUNCS FOCEXEC. Given a last name and first name, it generates a full name in the format Lastname, Firstname:

```
DEFINE FUNCTION DMPROPER
DESCRIPTION 'Convert name to proper case and last, first format'
(LASTNAME/A17, FIRSTNAME/A14)
DMPROPER/A34V=LCWORD(17, LASTNAME, 'A17')
|| (' , ' | LCWORD(14, FIRSTNAME, 'A14'));
END
```

The following is the DEFINE field named WHOLENAME added to the CUSTOMER Master File that calls the DEFINE FUNCTION:

```
DEFINE WHOLENAME/A40 = DF.DMFUNCS.DMPROPER(LASTNAME, FIRSTNAME);
DESCRIPTION = 'Calls DMPROPER to create full name', $
```

The following request uses the DEFINE field WHOLENAME:

```
TABLE FILE CUSTOMER
PRINT WHOLENAME AS Whole,Name
BY ID_CUSTOMER
WHERE ID_CUSTOMER LT 600
```

```
ON TABLE SET PAGE NOPAGE
END
```

The output is:

ID Customer	Whole Name
-----	-----
15	Nolan, Tyler
20	Bull, Joshua
78	Wood, Zara
124	Mckenzie, Callum
125	Charlton, Bradley
132	Griffiths, Henry
152	Rowe, Anthony
161	Storey, Max
185	Thomas, Evie
201	Birch, Brandon
213	Parry, Maisie
239	Barrett, Taylor
258	Lord, Harvey
270	Bell, Jay
312	Dunn, Daisy
352	Mckenzie, Callum
379	Fisher, Leo
454	Day, Zak
472	Howarth, Molly
503	Barrett, Daniel
531	Hargreaves, Chloe
566	Fitzgerald, Bethany

Using Date System Amper Variables in Master File DEFINES

Master File DEFINE fields can use Dialogue Manager system date variables to capture the system date each time the Master File is parsed for use in a request.

The format of the returned value for each date variable is the format indicated in the variable name. For example, &DATEYYMD returns a date value with the format YYMD. The exceptions are &DATE and &TOD, which return alphanumeric values and must be assigned

to a field with an alphanumeric format. The variable names &DATE and &TOD must also be enclosed in single quotation marks in the DEFINE expression.

The variables supported for use in Master File DEFINES are:

- &DATE
- &TOD
- &DATEMDY
- &DATEDMY
- &DATEYMD
- &DATEMDYY
- &DATEDMY
- &DATEYYMD
- &DMY
- &YMD
- &MDY
- &YYMD
- &MDYY
- &DMYY

Note that all other reserved ampers variables are not supported in Master Files.

Using the Date Variable &DATE in a Master File DEFINE

The following version of the EMPLOYEE Master File has the DEFINE field named TDATE added to it. TDATE has format A12 and retrieves the value of &DATE, which returns an alphanumeric value and must be enclosed in single quotation marks:

```
FILENAME=EMPLOYEE, SUFFIX=FOC
SEGNAME=EMPINFO, SEGTYPE=S1
FIELDNAME=EMP_ID, ALIAS=EID, FORMAT=A9, $
FIELDNAME=LAST_NAME, ALIAS=LN, FORMAT=A15, $
```



```

FIELDNAME=FIRST_NAME, ALIAS=FN, FORMAT=A10, $
FIELDNAME=HIRE_DATE, ALIAS=HDT, FORMAT=I6YMD, $
FIELDNAME=DEPARTMENT, ALIAS=DPT, FORMAT=A10, $
FIELDNAME=CURR_SAL, ALIAS=CSAL, FORMAT=D12.2M, $
FIELDNAME=CURR_JOBCODE, ALIAS=CJC, FORMAT=A3, $
FIELDNAME=ED_HRS, ALIAS=OJT, FORMAT=F6.2, $
DEFINE TDATE/A12 = '&DATE';, $
.
.
.

```

The following request displays the value of TDATE:

```

TABLE FILE EMPLOYEE
PRINT LAST_NAME FIRST_NAME HIRE_DATE TDATE AS 'TODAY''S,DATE'
WHERE LAST_NAME EQ 'BANNING'
END

```

The output is:

LAST_NAME	FIRST_NAME	HIRE_DATE	TODAY'S DATE
BANNING	JOHN	82/08/01	05/11/04

			TODAY'S
<u>LAST NAME</u>	<u>FIRST NAME</u>	<u>HIRE DATE</u>	<u>DATE</u>
BANNING	JOHN	82/08/01	06/17/04

Using the Date Variable &YYMD in a Master File DEFINE

The following version of the EMPLOYEE Master File has the DEFINE field named TDATE added to it. TDATE has the format YYMD and retrieves the value of &YYMD:

```

FILENAME=EMPLOYEE, SUFFIX=FOC
SEGNAME=EMPINFO, SEGTYPE=S1
FIELDNAME=EMP_ID, ALIAS=EID, FORMAT=A9, $
FIELDNAME=LAST_NAME, ALIAS=LN, FORMAT=A15, $

```

```

FIELDNAME=FIRST_NAME,    ALIAS=FN,        FORMAT=A10,      $
FIELDNAME=HIRE_DATE,     ALIAS=HDT,      FORMAT=I6YMD,   $
FIELDNAME=DEPARTMENT,    ALIAS=DPT,      FORMAT=A10,      $
FIELDNAME=CURR_SAL,      ALIAS=CSAL,     FORMAT=D12.2M,  $
FIELDNAME=CURR_JOBCODE,  ALIAS=CJC,      FORMAT=A3,       $
FIELDNAME=ED_HRS,        ALIAS=OJT,      FORMAT=F6.2,    $
DEFINE TDATE/YYMD      = &YYMD ;, $
.
.
.

```

The following request displays the value of TDATE:

```

TABLE FILE EMPLOYEE
PRINT LAST_NAME FIRST_NAME HIRE_DATE TDATE AS 'TODAY''S,DATE'
WHERE LAST_NAME EQ 'BANNING'
END

```

The output is:

LAST_NAME	FIRST_NAME	HIRE_DATE	TODAY'S DATE
BANNING	JOHN	82/08/01	2004/05/11

LAST NAME	FIRST NAME	HIRE DATE	TODAY'S DATE
BANNING	JOHN	82/08/01	2004/06/17

Messages for Date System Amper Variables in Master File DEFINES

The following message appears if an attempt is made to use an unsupported amper variable in a Master File DEFINE:

```
(FOC104) DEFINE IN MASTER REFERS TO A FIELD OUTSIDE ITS SCOPE: var
```

Parameterizing Master and Access File Values Using Variables

You can define global variables in a Master File and use them to parameterize certain attributes in the Master File and its corresponding Access File. For example, you can parameterize the connection attribute in the Access File with a variable you define in the Master File and then specify the actual connection name at run time.

Create a Master File Variable

Add variable definitions after the FILE declaration in the Master File:

```
VARIABLE NAME=[&&]var, USAGE=A\ln, [DEFAULT=defvalue,][QUOTED={OFF|ON},]
[PERSISTENT={ON|OFF},]$
```

where:

[&&]var

Is the name you are assigning to the global variable. When you reference the variable in the Master or Access File, you must prepend the name with two ampersands. However, the ampersands are optional when defining the variable.

ln

Is the maximum length for the variable value.

defvalue

Is the default value for the variable. If no value is set at run time, this value is used.

QUOTED = {OFF|ON}

ON adds single quotation marks around the assigned string for the variable. A single quotation mark within the string is converted to two single quotation marks. OFF is the default value.

PERSISTENT = {ON|OFF}

ON indicates that the default value assigned to this variable cannot be changed, preventing the use of this variable as a filter selection. The value ON is assigned to this

setting, by default.

OFF indicates that the default value assigned to this variable can be changed, permitting the use of this variable as a filter selection.

Support for Variables in Master and Access File Attributes

In the Master File, the following attributes can be parameterized with variables: POSITION, OCCURS, REMARKS, DESCRIPTION, TITLE, HELPMESSAGE.

In the DBA section of a Master File, the following attributes can be parameterized: USER, VALUE. For information about using these variables in a Master File profile to create dynamic DBA rules, see [Creating and Using a Master File Profile](#).

In the Access File, the following attributes can be parameterized with variables: CONNECTION, TABLENAME, WORKSHEET (Excel via Direct Retrieval) START, CHKPT_SAVE, CHKPT_FILE, POLLING, TIMEOUT, MAXLUWS, ACTION, MSGLIMIT, DIRECTORY, NAME, EXTENSION, DATA_ORIGIN, MAXFILES, MAXRECS, OBJECT, PICKUP, TRIGGER, DISCARD, ARCHIVE.

i Note: You can concatenate multiple variables to create an attribute value.

Parameterizing Attributes in a Master and Access File

The following request creates an Oracle table named ORAEMP from the FOCUS data source named EMPLOYEE:

```
TABLE FILE EMPLOYEE
SUM LAST_NAME FIRST_NAME CURR_SAL CURR_JOBCODE DEPARTMENT
BY EMP_ID
ON TABLE HOLD AS ORAEMP FORMAT SQLORA
END
```

The following is the Master File created by the request:

```

FILENAME=ORAEMP , SUFFIX=SQLORA , $
SEGMENT=SEG01, SEGTYPE=S0, $
  FIELDNAME=EMP_ID, ALIAS=EID, USAGE=A9, ACTUAL=A9, $
  FIELDNAME=LAST_NAME, ALIAS=LN, USAGE=A15, ACTUAL=A15, $
  FIELDNAME=FIRST_NAME, ALIAS=FN, USAGE=A10, ACTUAL=A10, $
  FIELDNAME=CURR_SAL, ALIAS=CSAL, USAGE=D12.2M, ACTUAL=D8, $
  FIELDNAME=CURR_JOBCODE, ALIAS=CJC, USAGE=A3, ACTUAL=A3, $
  FIELDNAME=DEPARTMENT, ALIAS=DPT, USAGE=A10, ACTUAL=A10, $

```

The following is the Access File created by the request:

```

SEGNAME=SEG01, TABLENAME=ORAEMP, KEYS=01, WRITE=YES, $

```

Add the following variable definitions to the Master File in order to parameterize the TABLENAME attribute in the Access File and the TITLE attribute for the EMP_ID column in the Master File:

```

FILENAME=ORAEMP, SUFFIX=SQLORA , $
VARIABLE NAME=table, USAGE=A8, DEFAULT=EDUCFILE, $
VARIABLE NAME=emptitle, USAGE=A30, DEFAULT=empid,$

```

Now, in the Master File, add the TITLE attribute to the FIELD declaration for EMP_ID:

```

FIELDNAME=EMP_ID, ALIAS=EID, USAGE=A9, ACTUAL=A9,
  TITLE='&&emptitle', $

```

In the Access File, replace the value for the TABLENAME attribute with the variable name:

```

SEGNAME=SEG01, TABLENAME=&&table, KEYS=01, WRITE=YES, $

```

The following request sets the values of the variables and then issues a TABLE request:

```

--SET &&table = ORAEMP;
--SET &&emptitle = 'Id,number';
TABLE FILE ORAEMP
PRINT EMP_ID LAST_NAME FIRST_NAME DEPARTMENT
END

```

Note that the value for &&emptitle is enclosed in single quotation marks in the --SET command because it contains a special character (the comma). The single quotation marks are not part of the string and do not display on the report output. The column title would

display enclosed in single quotation marks if the variable definition contained the attribute QUOTED=ON.

On the report output, the column title for the employee ID column displays the value set for &emptitle, and the table accessed by the request is the ORAEMP table created as the first step in the example:

Id number	LAST_NAME	FIRST_NAME	DEPARTMENT
-----	-----	-----	-----
071382660	STEVENS	ALFRED	PRODUCTION
112847612	SMITH	MARY	MIS
117593129	JONES	DIANE	MIS
119265415	SMITH	RICHARD	PRODUCTION
119329144	BANNING	JOHN	PRODUCTION
123764317	IRVING	JOAN	PRODUCTION
126724188	ROMANS	ANTHONY	PRODUCTION
219984371	MCCOY	JOHN	MIS
326179357	BLACKWOOD	ROSEMARIE	MIS
451123478	MCKNIGHT	ROGER	PRODUCTION
543729165	GREENSPAN	MARY	MIS
818692173	CROSS	BARBARA	MIS

Concatenating Variables to Create an Attribute Value

In the following example, the TABLENAME attribute requires a multipart name consisting of a database name, an owner ID, a table prefix, and a static table name with a variable suffix. In this case, you can define separate variables for the different parts and concatenate them.

First, define separate variables for each part:

```
VARIABLE NAME=db,USAGE=A8,DEFAULT=mydb,$
VARIABLE NAME=usr,USAGE=A8,DEFAULT=myusrid,$
VARIABLE NAME=tprf,USAGE=A4,DEFAULT=test_, $
VARIABLE NAME=tsuf,USAGE=YYM,$
```

In the Access File, concatenate the variables to create the TABLENAME attribute. Note that the separator for between each part is a period, but to concatenate a variable name and retain the period, you must use two periods:

```
TABLENAME=&db..&usr..&tprf.table&tsuf,
```

Based on the defaults, the TABLENAME would be:

```
TABLENAME=mydb.myusrid.test_table
```

In a request, set the following values for the separate variables:

```
I-SET &&db=db1;  
-SET &&tprf=prod_  
-SET &&tsuf=200801;
```

With these values, the TABLENAME used is the following:

```
TABLENAME=db1.myusrid.prod_table200801
```

Converting Alphanumeric Dates to FOCUS Dates

In some data sources, date values are stored in alphanumeric format without any particular standard, with any combination of components, such as year, quarter, and month, and with any delimiter. In a sorted report, if such data is sorted alphabetically, the sequence does not make business sense. To ensure adequate sorting, aggregation, and reporting on date fields, FOCUS can convert the alphanumeric dates into standard FOCUS date format using a conversion pattern that you can specify in the Master File attribute called DATEPATTERN.

Each element in the pattern is either a constant character which must appear in the actual input or a variable that represents a date component. You must edit the USAGE attribute in the Master File so that it accounts for the date elements in the date pattern. The maximum length of the DATEPATTERN string is 64.

Usage Notes for DATEPATTERN

- If your original date has elements with no FOCUS USAGE format equivalent, the converted date will not look like the original data. In that case, if you want to display the original data, you may be able to use an OCCURS segment to redefine the field with the original alphanumeric format and display that field in the request.
- DATEPATTERN requires an ACTUAL format to USAGE format conversion. Therefore, it is not supported for SUFFIX=FOC and SUFFIX=XFOC data sources.

Specifying Variables in a Date Pattern

The valid date components (variables) are year, quarter, month, day, and day of week. In the date pattern, variables are enclosed in square brackets (these brackets are not part of the input or output. Note that if the data contains brackets, you must use an escape character in the date pattern to distinguish the brackets in the data from the brackets used for enclosing variables).

Specify Years in a Date Pattern

[YYYY]

Specifies a four-digit year.

[YYYY]

Specifies a four-digit year.

[YY]

Specifies a two-digit year.

[yy]

Specifies a zero-suppressed two-digit year (for example, 8 for 2008).

[by]

Specifies a blank-padded two-digit year.

Specify Month Numbers in a Date Pattern

[MM]

Specifies a two-digit month number.

[mm]

Specifies a zero-suppressed month number.

[bm]

Specifies a blank-padded month number.

Specify Month Names in a Date Pattern

[MON]

Specifies a three-character month name in upper case.

[mon]

Specifies a three-character month name in lower case.

[Mon]

Specifies a three-character month name in mixed case.

[MONTH]

Specifies a full month name in upper case.

[month]

Specifies a full month name in lower case.

[Month]

Specifies a full month name in mixed case.

Specify Days of the Month in a Date Pattern

[DD]

Specifies a two-digit day of the month.

[dd]

Specifies a zero-suppressed day of the month.

[bd]

Specifies a blank-padded day of the month.

Specify Julian Days in a Date Pattern

[DDD]

Specifies a three-digit day of the year.

[ddd]

Specifies a zero-suppressed day of the year.

[bdd]

Specifies a blank-padded day of the year.

Specify Day of the Week in a Date Pattern

[WD]

Specifies a one-digit day of the week.

[DAY]

Specifies a three-character day name in upper case.

[day]

Specifies a three-character day name in lower case.

[Day]

Specifies a three-character day name in mixed case.

[WDAY]

Specifies a full day name in upper case.

[wday]

Specifies a full day name in lower case.

[Wday]

Specifies a full day name in mixed case.

For the day of the week, the WEEKFIRST setting defines which day is day 1.

Specify Quarters in a Date Pattern

[Q]

Specifies a one-digit quarter number (1, 2, 3, or 4).

For a string like Q2 or Q02, use constants before [Q], for example, Q0[Q].

Specifying Constants in a Date Pattern

Between the variables, you can insert any constant values.

If you want to insert a character that would normally be interpreted as part of a variable, use the backslash character as an escape character. For example:

- Use \[to specify a left square bracket constant character.
- Use \\ to specify a backslash constant character.

For a single quotation mark, use two consecutive single quotation marks (').

Sample Date Patterns

If the date in the data source is of the form CY 2001 Q1, the DATEPATTERN attribute is:

```
DATEPATTERN = 'CY [YYYY] Q[Q]'
```

If the date in the data source is of the form Jan 31, 01, the DATEPATTERN attribute is:

```
DATEPATTERN = '[Mon] [DD], [YY]'
```

If the date in the data source is of the form APR-06, the DATEPATTERN attribute is:

```
DATEPATTERN = '[MON]-[YY]'
```

If the date in the data source is of the form APR - 06, the DATEPATTERN attribute is:

```
DATEPATTERN = '[MON] - [YY]'
```

If the date in the data source is of the form APR '06, the DATEPATTERN attribute is:

```
DATEPATTERN = '[MON] ''[YY]'
```

If the date in the data source is of the form APR [06], the DATEPATTERN attribute is:

```
DATEPATTERN = '[MON] \[[YY]\]' (or '[MON] \[[YY]]')
```

Note that the right square bracket does not have to be escaped.

Sorting By an Alphanumeric Date

In the following example, DATE1 is a sequential file containing the following data:

```
June 1, '02
June 2, '02
June 3, '02
June 10, '02
June 11, '02
June 12, '02
```

```

June 20, '02
June 21, '02
June 22, '02
June 1, '03
June 2, '03
June 3, '03
June 10, '03
June 11, '03
June 12, '03
June 20, '03
June 21, '03
June 22, '03
June 1, '04
June 2, '04
June 3, '04
June 4, '04
June 10, '04
June 11, '04
June 12, '04
June 20, '04
June 21, '04
June 22, '04

```

In the DATE1 Master File, the DATE1 field has alphanumeric USAGE and ACTUAL formats, each A18:

```

FILENAME=DATE1 , SUFFIX=FIX ,
DATASET = 'USER1.DATE1.FOCTEMP' , $
SEGMENT=FILE1, SEGTYPE=S0, $
FIELDNAME=DATE1, ALIAS=E01, USAGE=A18, ACTUAL=A18, $

```

The following request sorts by the DATE1 FIELD:

```

TABLE FILE DATE1
PRINT DATE1 NOPRINT
BY DATE1
ON TABLE SET PAGE NOPAGE
END

```

The output shows that the alphanumeric dates are sorted alphabetically, not chronologically:

```

DATE1
-----
June 1, '02
June 1, '03
June 1, '04
June 10, '02
June 10, '03
June 10, '04
June 11, '02
June 11, '03
June 11, '04
June 12, '02
June 12, '03
June 12, '04
June 2, '02
June 2, '03
June 2, '04
June 20, '02
June 20, '03
June 20, '04
June 21, '02
June 21, '03
June 21, '04
June 22, '02
June 22, '03
June 22, '04
June 3, '02
June 3, '03
June 3, '04
June 4, '04

```

In order to sort the data correctly, you can add a DATEPATTERN attribute to the Master File that enables FOCUS to convert the date to a FOCUS date field. You must also edit the USAGE format to make it a FOCUS date format. To construct the appropriate pattern, you must account for all of the components in the stored date. The alphanumeric date has the following variables and constants:

- Variable: full month name in mixed case, [Month].
- Constant: blank space.
- Variable: zero-suppressed day of the month number, [dd].
- Constant: comma followed by a blank space followed by an apostrophe (coded as two apostrophes in the pattern).

- Variable: two-digit year, [YY].

The edited Master File follows. Note the addition of the DEFCENT attribute to convert the two-digit year to a four-digit year:

```
FILENAME=DATE1    , SUFFIX=FIX  ,
  DATASET = 'USER1.DATE1.FOCTEM'P    , $
  SEGMENT=FILE1, SEGTYPE=S0, $
  FIELDNAME=DATE1, ALIAS=E01, USAGE=MtrDYY, ACTUAL=A18,
  DEFCENT=20,
  DATEPATTERN = '[Month] [dd], ''[YY]'' , $
```

Now, issuing the same request produces the following output. Note that DATE1 has been converted to a FOCUS date in MtrDYY format (as specified in the USAGE format):

```
DATE1
-----
June  1, 2002
June  2, 2002
June  3, 2002
June 10, 2002
June 11, 2002
June 12, 2002
June 20, 2002
June 21, 2002
June 22, 2002
June  1, 2003
June  2, 2003
June  3, 2003
June 10, 2003
June 11, 2003
June 12, 2003
June 20, 2003
June 21, 2003
June 22, 2003
June  1, 2004
June  2, 2004
June  3, 2004
June  4, 2004
June 10, 2004
June 11, 2004
June 12, 2004
June 20, 2004
June 21, 2004
June 22, 2004
```

Describing a Sequential, VSAM, or ISAM Data Source

You can describe and report from sequential, VSAM, and ISAM data sources.

In a sequential data source, records are stored and retrieved in the same order as they are entered.

With VSAM and ISAM data sources, a new element is introduced: the key or group key. A group key consists of one or more fields, and can be used to identify the various record types in the data source. In the Master File representation of a data source with different record types, each record type is assigned its own segment.

For VSAM and ISAM data sources, you must allocate the Master File name to the CLUSTER component of the data source.

For information about working with compressed VSAM and sequential files, see [User Exits for a Non-FOCUS Data Source](#).

For information about updating VSAM data sources, see the *VSAM Write Data Adapter User's Manual*.

Sequential Data Source Formats

Sequential data sources formatted in the following ways are recognized:

- Fixed-format, in which each field occupies a predefined position in the record.
- Delimited, in which fields can occupy any position in a record and are separated by a delimiter:
 - Comma-delimited or tab-delimited, in which fields can occupy any position in a record and are separated by a comma or a tab, respectively. Ending a line terminates the record.

Free-format is a type of comma-delimited data source in which a record can span multiple lines and is terminated by a comma-dollar sign (,\$) character

combination.

- Token-delimited, in which the delimiter can be any combination of characters. For more information on describing token-delimited files, see [Describing a Token-Delimited Data Source](#).

i Note: SET HOLDLIST is not supported for delimited files.

You can describe two types of sequential data sources:

- **Simple.** This is the most basic type, consisting of only one segment. It is supported in all formats.
- **Complex.** This is a multi-segment data source. The descendant segments exist in the data source as multiply occurring fields (which are supported in both fixed-format and free-format) or multiple record types (which are supported only in fixed-format).

What Is a Fixed-Format Data Source?

Fixed-format data sources are sequential data sources in which each field occupies a predefined position in the record. You describe the record format in the Master File.

For example, a fixed-format record might look like this:

```
1352334556George Eliot The Mill on the Floss H
```

The simplest form of a fixed-record data source can be described by providing just field declarations. For example, suppose you have a data source for a library that consists of the following components:

- A number, like an ISBN number, that identifies the book by publisher, author, and title.
- The name of the author.
- The title of the book.
- A single letter that indicates whether the book is hard-bound or soft-bound.
- The book's price.
- A serial number that actually identifies the individual copies of the book in the library

(a call number).

- A synopsis of the book.

This data source might be described with the seven field declarations shown here:

```
FIELDNAME = PUBNO      ,ALIAS = PN   ,USAGE = A10   ,ACTUAL = A10   ,,$
FIELDNAME = AUTHOR    ,ALIAS = AT   ,USAGE = A25   ,ACTUAL = A25   ,,$
FIELDNAME = TITLE     ,ALIAS = TL   ,USAGE = A50   ,ACTUAL = A50   ,,$
FIELDNAME = BINDING   ,ALIAS = BI   ,USAGE = A1    ,ACTUAL = A1    ,,$
FIELDNAME = PRICE     ,ALIAS = PR   ,USAGE = D8.2N ,ACTUAL = D8    ,,$
FIELDNAME = SERIAL    ,ALIAS = SN   ,USAGE = A15   ,ACTUAL = A15   ,,$
FIELDNAME = SYNOPSIS  ,ALIAS = SYN  ,USAGE = A150  ,ACTUAL = A150  ,,$
```

i Note:

- Each declaration begins with the word FIELDNAME, and normally contains four elements (a FIELDNAME, an ALIAS, a USAGE attribute, and an ACTUAL attribute).
- ALIAS=, USAGE=, and ACTUAL= may be omitted as identifiers, since they are positional attributes following FIELDNAME.
- If you omit the optional ALIAS, its absence must be signaled by a second comma between FIELDNAME and USAGE (FIELDNAME=PUBNO,,A10,A10,\$).
- Both the USAGE and the ACTUAL attributes must be included. Failure to specify both is a common cause of errors in describing non-FOCUS data sources (FOCUS data sources do not have ACTUAL attributes).
- Each declaration can span multiple lines and must be terminated with a comma followed by a dollar sign (,\$). Typically, the LRECL for a Master File is 80 and the RECFM is F. Support also exists for LRECL up to 32K and RECFM V.
- When using Maintain Data to read a fixed-format data source, the record length as described in the Master File may not exceed the actual length of the data record (the LRECL value).

You must describe the entire record. The values for field name and alias can be omitted for fields that do not need to be accessed. This is significant when using existing data sources, because they frequently contain information that you do not need for your requests. You describe only the fields to include in your reports or calculations, and use filler fields to represent the rest of the logical record length (LRECL) of the data source.

In the above example, the book synopsis is hardly necessary for most reports. The synopsis can therefore be replaced with a filler field, as follows:

```
FIELDNAME = FILLER, ALIAS = FILL1, USAGE = A150, ACTUAL = A150,$
```

Fillers of this form may contain up to 4095 characters. If you need to describe larger areas, use several filler fields together:

```
FIELDNAME = FILLER, ,A256,A256,$
FIELDNAME = FILLER, ,A200,A200,$
```

The field name FILLER is no different than any other field name. To prevent access to the data in the field, you can use a blank field name. For example:

```
FIELDNAME = , ,A200,A200,$
```

It is recommended that you include file and segment attributes, even for simple data sources, to complete your documentation. The example below shows the Master File for the library data source with file and segment declarations added.

```
FILENAME = LIBRARY1, SUFFIX = FIX,$
SEGNAME = BOOKS, SEGTYPE = S0,$
FIELDNAME = PUBNO ,ALIAS = PN ,USAGE = A10 ,ACTUAL = A10 ,,$
FIELDNAME = AUTHOR ,ALIAS = AT ,USAGE = A25 ,ACTUAL = A25 ,,$
FIELDNAME = TITLE ,ALIAS = TL ,USAGE = A50 ,ACTUAL = A50 ,,$
FIELDNAME = BINDING ,ALIAS = BI ,USAGE = A1 ,ACTUAL = A1 ,,$
FIELDNAME = PRICE ,ALIAS = PR ,USAGE = D8.2N ,ACTUAL = D8 ,,$
FIELDNAME = SERIAL ,ALIAS = SN ,USAGE = A15 ,ACTUAL = A15 ,,$
FIELDNAME = FILLER ,ALIAS = FILL1 ,USAGE = A150 ,ACTUAL = A150 ,,$
```

What Is a Comma or Tab-Delimited Data Source?

Master Files for comma-delimited and tab-delimited sequential data sources can have SUFFIX values of COM, COMT, TAB, or TABT. Comma-delimited data sources are sequential data sources in which field values are separated by commas. Tab-delimited data sources are sequential data sources in which field values are separated by tabs.

i Note: SET HOLDLIST is not supported for delimited files.

You can also create delimited files using any token as the delimiter. For more information, see [Describing a Token-Delimited Data Source](#).

You can use the SET HNODATA command to specify how to propagate missing data to these data sources when you create them using the HOLD command. For more information, see the *Developing Applications* manual.

For the SUFFIX values of COM, COMT, TAB and TABT, if the data is numeric and has a zoned format (ACTUAL=Zn), the data must be unsigned (cannot contain a positive or negative value).

Accessing SUFFIX=COM Data Sources

A Master File containing the attribute SUFFIX=COM can be used to access two styles of comma-delimited sequential data sources:

- Free-format style is described in [What Is a Free-Format Data Source?](#). Character values are not enclosed in double quotation marks, and the comma-dollar sign character combination terminates the record. With this style of comma-delimited data source, records can span multiple lines. A field that contains a comma as a character must be enclosed within single quotation marks.
- The second style is consistent with the current industry standard for comma-delimited data sources. Character values are enclosed in double quotation marks, and the cr/lf (carriage-return, line-feed) character combination terminates the record, although the comma-dollar sign combination is also accepted. In addition, each input record must be completely contained on a single input line. A double quotation mark within a field is identified by two consecutive double quotation marks.

Note that the setting PCOMMA=ON is required in conjunction with the SUFFIX=COM Master File when accessing this type of data source in order to interpret the double quotation marks around character values correctly. Without this setting, the double quotation marks are considered characters within the field, not delimiters enclosing the field values.

Accessing SUFFIX=COMT Data Sources

A Master File containing the attribute SUFFIX=COMT can be used to access comma-delimited sequential data sources in which all of the following conditions are met:

- The first record of the data source contains column titles. This record is ignored when the data source is accessed in a request.
- Character values are enclosed in double quotation marks. A double quotation mark within a field is identified by two consecutive double quotation marks.
- Each record is completely contained on one line and terminated with the cr/lf character combination.

Accessing SUFFIX=TAB Data Sources

A Master File containing the attribute SUFFIX=TAB can be used to access tab-delimited sequential data sources in which all of the following conditions are met:

- Character values are not enclosed in double quotation marks.
- Each record is completely contained on one line and terminated with the cr/lf character combination.

Accessing SUFFIX=TABT Data Sources

A Master File containing the attribute SUFFIX=TABT can be used to access tab-delimited sequential data sources in which all of the following conditions are met:

- The first record of the data source contains column titles. This record is ignored when the data source is accessed in a request.
- Character values are not enclosed in double quotation marks.
- Each record is completely contained on one line and terminated with the cr/lf character combination.

What Is a Free-Format Data Source?

A common type of external structure is a comma-delimited sequential data source. These data sources are a convenient way to maintain low volumes of data, since the fields in a record are separated from one another by commas rather than being padded with blanks or zeroes to fixed field lengths. Comma-delimited data sources must be stored as physical sequential data sources.

i Note: SET HOLDLIST is not supported for delimited files.

The report request language processes free-format comma-delimited data sources the same way it processes fixed-format data sources. The same procedure is used to describe these data sources in a comma-delimited Master File. The only difference is that the file suffix is changed to COM, as shown:

```
FILENAME = filename, SUFFIX = COM,$
```

i Note: Free-format comma-delimited data sources do not have character fields enclosed in double quotation marks, and use the comma-dollar sign character combination to terminate the record.

You can use the system editor to change values, add new records, and delete records. Since the number of data fields on a line varies depending on the presence or absence of fields and the actual length of the data values, a logical record may be one or several lines. Hence, you need to use a terminator character to signal the end of the logical record. This is a dollar sign following the last comma (,\$).

A section of comma-delimited data might look like this:

```
PUBNO=1352334556, AUTHOR='Eliot, George',  
TITLE='The Mill on the Floss', BINDING=H,$
```

The order in which the data values are described in the Master File plays an important role in comma-delimited data sources. If the data values are typed in their natural order, then only commas between the values are necessary. If a value is out of its natural order, then it is identified by its name or alias and an equal sign preceding it, for example, AUTHOR='Eliot, George'.

Rules for Maintaining a Free-Format Data Source

If a logical record contains every data field, it contains the same number of commas used as delimiters as there are data fields. It also has a dollar sign following the last comma, signaling the end of the logical record. Thus, a logical record containing ten data fields contains ten commas as delimiters, plus a dollar sign record terminator.

A logical record may occupy as many lines in the data source as is necessary to contain the data. A record terminator (,\$) must follow the last physical field.

Each record need not contain every data field, however. The identity of a data field that might be out of sequence can be provided in one of the following ways:

- You can use the field name, followed by an equal sign and the data value.
- You can use the field alias, followed by an equal sign and the data value.
- You can use the shortest unique truncation of the field name or alias, followed by an equal sign and the data value.
- If a field name is not mentioned, it inherits its value from the prior record.

Thus, the following statements are all equivalent:

```
BI=H, PRICE=17.95,$  
BI=H, PR=17.95,$  
BI=H, P=17.95,$
```

Standard Master File Attributes for a Sequential Data Source

Most standard Master File attributes are used with sequential data sources in the standard way. For more information, see [Identifying a Data Source](#), [Describing a Group of Fields](#), and [Describing an Individual Field](#).

- **SEGTYPE.** The SEGTYPE attribute is ignored with free-format data sources.

The SEGTYPE value for fixed-format data sources has a default of S0. However, if you

use keyed retrieval, the SEGTYPE value depends on the number of keys and sort sequence. See [Describing a FOCUS Data Source](#), for a description of the SEGTYPE attribute. For a description of keyed retrieval from fixed-format data sources, see the *FOCUS® Creating Reports* manual.

- **ACTUAL.** The ACTUAL values for sequential data sources are described in [Describing an Individual Field](#).

Note that file and segment declarations are optional for simple sequential data sources that you are not joining. However, they are recommended in order to make the data source description self-documenting, and to give you the option of joining the data source in the future.

Standard Master File Attributes for a VSAM or ISAM Data Source

Most standard Master File attributes are used with VSAM and ISAM data sources in the standard way. For more information, see [Identifying a Data Source](#), [Describing a Group of Fields](#), and [Describing an Individual Field](#).

- **SUFFIX.** The SUFFIX attribute in the file declaration for these data sources has the value VSAM or ISAM.
- **SEGNAME.** The SEGNAME attribute of the first or root segment in a Master File for a VSAM or ISAM data source must be ROOT. The remaining segments can have any valid segment name.

The only exception involves unrelated RECTYPES, where the root SEGNAME must be DUMMY.

All non-repeating data goes in the root segment. The remaining segments may have any valid name from one to eight characters.

Any segment except the root is the descendant, or child, of another segment. The PARENT attribute supplies the name of the segment that is the hierarchical parent or owner of the current segment. If no PARENT attribute appears, the default is the immediately preceding segment. The PARENT name may be one to eight characters.

- **SEGTYPE.** The SEGTYPE attribute should be S0 for VSAM data sources. (For a general description of the SEGTYPE attribute, see [Describing a Group of Fields](#).)
- **GROUP.** The keys of a VSAM or ISAM data source are defined in the segment

declarations as GROUPs consisting of one or more fields.

Describing a Group Field With Formats

A single-segment data source may have only one key field, but it must still be described with a GROUP declaration. The group must have ALIAS=KEY.

Groups can also be assigned simply to provide convenient reference names for groups of fields. Suppose that you have a series of three fields for an employee: last name, first name, and middle initial. You use these three fields consistently to identify the employee. You can identify the three fields in your Master File as a GROUP named EMPINFO. Then, you can refer to these three linked fields as a single unit, called EMPINFO. When using the GROUP feature for non-keys, the parameter ALIAS= must still be used, but should not equal KEY.

For group fields, you must supply both the USAGE and ACTUAL formats in alphanumeric format. The length must be exactly the sum of the subordinate field lengths.

The GROUP declaration USAGE attribute specifies how many positions to use to describe the key in a VSAM KSDS data source. If a Master File does not completely describe the full key at least once, the following warning message appears:

```
(FOC1016) INVALID KEY DESCRIPTION IN MASTER FILE
```

The cluster key definition is compared to the Master File for length and displacement.

When you expand on the key in a RECTYPE data source, describe the key length in full on the last non-OCCURS segment on each data path.

Do not describe a group with ALIAS=KEY for OCCURS segments.

If the fields that make up a group key are not alphanumeric fields, the format of the group key is still alphanumeric, but its length is determined differently. The ACTUAL length is still the sum of the subordinate field lengths. The USAGE format, however, is the sum of the internal storage lengths of the subordinate fields because regardless of the data types, the group will be displayed as alphanumeric. You determine these internal storage lengths as follows:

- Fields of type I have a value of 4.
- Fields of type F have a value of 4.

- Fields of type P that are 8 bytes can have a USAGE of P15.x or P16 (sign and decimal for a total of 15 digits). Fields that are 16 bytes have a USAGE of P16.x, P17 or larger.
- Fields of type D have a value of 8.
- Alphanumeric fields have a value equal to the number of characters they contain as their field length.

i Note:

- Since all group fields must be defined in alphanumeric format, those that include numeric component fields should not be used as verb objects in a report request.
- The MISSING attribute is not supported on the group field, but is supported on the individual fields comprising the group.

Describe a VSAM Group Field With Formats

```
GROUP = keyname, ALIAS = KEY, USAGE = Ann, ACTUAL = Ann , $
```

where:

keyname

Can have up to 66 characters.

Describing a VSAM Group Field With Formats

In the library data source, the first field, PUBNO, can be described as a group key. The publisher number consists of three elements: a number that identifies the publisher, one that identifies the author, and one that identifies the title. They can be described as a group key, consisting of a separate field for each element if the data source is a VSAM data structure.

The Master File looks as follows:

```
FILE = LIBRARY5, SUFFIX = VSAM, $
SEGMENT = ROOT, SEGTYPE = S0, $
```

```

GROUP = BOOKKEY      ,ALIAS = KEY ,USAGE = A10    ,ACTUAL = A10    ,,$
FIELDNAME = PUBNO    ,ALIAS = PN ,USAGE = A3     ,ACTUAL = A3     ,,$
FIELDNAME = AUTHNO   ,ALIAS = AN ,USAGE = A3     ,ACTUAL = A3     ,,$
FIELDNAME = TITLNO   ,ALIAS = TN ,USAGE = A4     ,ACTUAL = A4     ,,$
FIELDNAME = AUTHOR   ,ALIAS = AT ,USAGE = A25    ,ACTUAL = A25    ,,$
FIELDNAME = TITLE    ,ALIAS = TL ,USAGE = A50    ,ACTUAL = A50    ,,$
FIELDNAME = BINDING  ,ALIAS = BI ,USAGE = A1     ,ACTUAL = A1     ,,$
FIELDNAME = PRICE    ,ALIAS = PR ,USAGE = D8.2N  ,ACTUAL = D8     ,,$
FIELDNAME = SERIAL   ,ALIAS = SN ,USAGE = A15    ,ACTUAL = A15    ,,$
FIELDNAME = SYNOPSIS ,ALIAS = SY ,USAGE = A150   ,ACTUAL = A150   ,,$
FIELDNAME = RECTYPE  ,ALIAS = B  ,USAGE = A1     ,ACTUAL = A1     ,,$

```

Describing a VSAM Group Field With Multiple Formats

```

GROUP = A, ALIAS = KEY, USAGE = A14, ACTUAL = A8    ,,$
FIELDNAME = F1, ALIAS = F1, USAGE = P6, ACTUAL=P2  ,,$
FIELDNAME = F2, ALIAS = F2, USAGE = I9, ACTUAL=I4  ,,$
FIELDNAME = F3, ALIAS = F3, USAGE = A2, ACTUAL=A2  ,,$

```

The lengths of the ACTUAL attributes for subordinate fields F1, F2, and F3 total 8, which is the length of the ACTUAL attribute of the group key. The display lengths of the USAGE attributes for the subordinate fields total 17. However, the length of the group key USAGE attribute is found by adding their internal storage lengths as specified by their field types: 8 for USAGE=P6, 4 for USAGE=I9, and 2 for USAGE=A2, for a total of 14.

Accessing a Group Field With Multiple Formats

When you use a group field with multiple formats in a query, you must account for each position in the group, including trailing blanks or leading zeros. The following example illustrates how to access a group field with multiple formats in a query:

```

GROUP = GRPB, ALIAS = KEY, USAGE = A8, ACTUAL = A8 ,,$
FIELDNAME = FIELD1, ALIAS = F1, USAGE = A2, ACTUAL = A2 ,,$
FIELDNAME = FIELD2, ALIAS = F2, USAGE = I8, ACTUAL = I4 ,,$
FIELDNAME = FIELD3, ALIAS = F3, USAGE = A2, ACTUAL = A2 ,,$

```

The values in fields F1 and F3 may include some trailing blanks, and the values in field F2 may include some leading zeros. When using the group in a query, you must account for each position. Because FIELD2 is a numeric field, you cannot specify the IF criteria as follows:

```
IF GRPB EQ 'A 0334BB'
```

You can eliminate this error by using a slash (/) to separate the components of the group key:

```
IF GRPB EQ 'A/334/BB'
```

i Note: Blanks and leading zeros are assumed where needed to fill out the key.

Describing a Group Field as a Set of Elements

A GROUP declaration in a Master File describes several fields as a single entity. One use of a group is to describe Group keys in a VSAM data source. Sometimes referring to several fields by one group name facilitates ease of reporting.

Traditionally, when describing a GROUP field, you had to take account of the fact that while the USAGE and ACTUAL format for the GROUP field are both alphanumeric, the length portion of the USAGE format for the group had to be calculated as the sum of the component lengths, where each integer or single precision field counted as 4 bytes, each double precision field as 8 bytes, and each packed field counted as either 8 or 16 bytes depending on its size.

To avoid the need to calculate these lengths, you can use the GROUP ELEMENTS option, which describes a group as a set of elements without USAGE and ACTUAL formats.

Describe a GROUP Field as a Set of Elements

```
GROUP=group1, ALIAS=g1a1ias,ELEMENTS=n1,$
    FIELDNAME=field11, ALIAS=alias11, USAGE=ufmt11, ACTUAL=afmt11, $
```

```

.
.
.
  FIELDNAME=field1h, ALIAS=alias1h, USAGE=ufmt1h, ACTUAL=afmt1h, $
GROUP=group2,ALIAS=g2alias,ELEMENTS=n2,$
  FIELDNAME=field21, ALIAS=alias21, USAGE=ufmt21, ACTUAL=afmt21, $
.
.
.
  FIELDNAME=field2k, ALIAS=alias2k, USAGE=ufmt2k, ACTUAL=afmt2k, $

```

where:

group1, group2

Are valid names assigned to a group of fields. The rules for acceptable group names are the same as the rules for acceptable field names.

n1, n2

Are the number of elements (fields and/or groups) that compose the group. If a group is defined within another group, the subgroup (with all of its elements) counts as one element of the parent group.

field11, field2k

Are valid field names.

alias11, alias2k

Are valid alias names.

ufmt11, ufmt2k

Are USAGE formats for each field.

afmt11, afmt2k

Are ACTUAL formats for each field.

Usage Notes for Group Elements

- To use the ELEMENTS attribute, the GROUP field declaration should specify only a

group name and number of elements.

- If a group declaration specifies USAGE and ACTUAL *without* the ELEMENTS attribute, the USAGE and ACTUAL are accepted as specified, even if incorrect.
- If a group declaration specifies USAGE and ACTUAL *with* the ELEMENTS attribute, the ELEMENTS attribute takes precedence.
- Each subgroup counts as one element. Its individual fields and subgroups do not count in the number of elements of the parent group.

Declaring a GROUP With ELEMENTS

In the following Master File, GRP2 consists of two elements, fields FIELDA and FIELDDB. GRP1 consists of two elements, GRP2 and field FIELDDC. Field FIELDDD is not part of a group:

```
FILENAME=XYZ      , SUFFIX=FIX      , $
SEGMENT=XYZ, SEGTYPE=S2, $
GROUP=GRP1, ALIAS=CCR, ELEMENTS=2, $
  GROUP=GRP2, ALIAS=CC, ELEMENTS=2, $
    FIELDNAME=FIELDA, ALIAS=E01, USAGE=A10, ACTUAL=A10, $
    FIELDNAME=FIELDDB, ALIAS=E02, USAGE=A16, ACTUAL=A16, $
    FIELDNAME=FIELDDC, ALIAS=E03, USAGE=P27, ACTUAL=A07, $
    FIELDNAME=FIELDDD, ALIAS=E04, USAGE=D7, ACTUAL=A07, $
```

The following chart shows the offsets and formats of these fields.

Field Number	Field Name	Offset	USAGE	ACTUAL
1	GRP1	0	A42 - Supports 16 characters for FIELDDC (P27)	A33
2	GRP2	0	A26	A26
3	FIELDA	0	A10	A10
4	FIELDDB	10	A16	A16

Field Number	Field Name	Offset	USAGE	ACTUAL
5	FIELD C	26	P27	A7
6	FIELD D	42	D7	A7

Note that the display characteristics of the group have not changed. The mixed format group GRP1 will still display as all alphanumeric.

Describing a Multiply Occurring Field in a Free-Format Data Source

Since any data field not explicitly referred to in a logical record continues to have the same value as it did the last time one was assigned, up until the point a new data value is entered, a free-format sequential data source can resemble a hierarchical structure. The parent information needs to be entered only once, and it carries over for each descendant segment.

Describing a Multiply Occurring Field in a Free-Format Data Source

Consider the example of a library data source. The information for two copies of *The Sun Also Rises*, one hardcover and one paperback, can be entered as follows:

```
PUBNO=1234567890, AUTHOR='Hemingway, Ernest',
TITLE='The Sun Also Rises',
BI=H,PR=17.95, $
BI=S,PR=5.25, $
```

There are two values for binding and price, which both correspond to the same publisher number, author, and title. In the Master File, the information that occurs only once (the publisher number, author, and title) is placed in one segment, and the information that occurs several times in relation to this information is placed in a descendant segment.

Similarly, information that occurs several times in relation to the descendant segment, such as an individual serial number for each copy of the book, is placed in a segment that is a descendant of the first descendant segment, as shown in the following diagram:

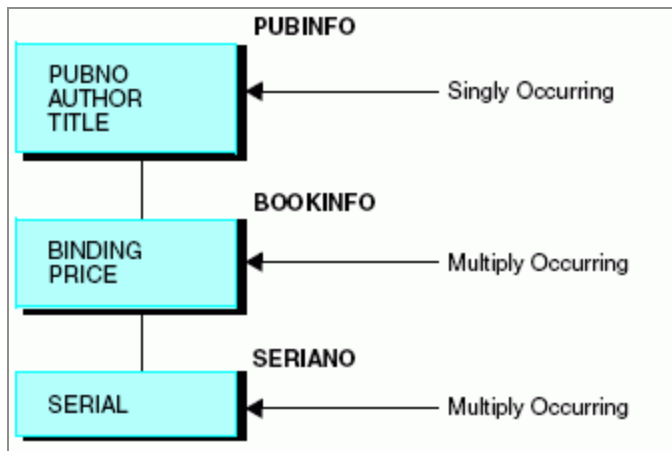

Describe this data source as follows:

```

FILENAME = LIBRARY4, SUFFIX = COM, $
SEGNAME = PUBINFO, SEGTYPE=S0, $
  FIELDNAME = PUBNO, ALIAS = PN, USAGE = A10, ACTUAL = A10, $
  FIELDNAME = AUTHOR, ALIAS = AT, USAGE = A25, ACTUAL = A25, $
  FIELDNAME = TITLE, ALIAS = TL, USAGE = A50, ACTUAL = A50, $
SEGNAME = BOOKINFO, PARENT = PUBINFO, SEGTYPE=S0, $
  FIELDNAME = BINDING, ALIAS = BI, USAGE = A1, ACTUAL = A1, $
  FIELDNAME = PRICE, ALIAS = PR, USAGE = D8.2N, ACTUAL = D8, $
SEGNAME = SERIANO, PARENT = BOOKINFO, SEGTYPE=S0, $
  FIELDNAME = SERIAL, ALIAS = SN, USAGE = A15, ACTUAL = A15, $
  
```

Note that each segment other than the first has a PARENT attribute. You use the PARENT attribute to signal that you are describing a hierarchical structure.

Describing a Multiply Occurring Field in a Fixed-Format, VSAM, or ISAM Data Source

Fixed-format sequential, VSAM, or ISAM data sources can have repeating fields. Consider the following data structure:



Fields C1 and C2 repeat within this data record. C1 has an initial value, as does C2. C1 then provides a second value for that field, as does C2. Thus, there are two values for fields C1 and C2 for every one value for fields A and B.

The number of times C1 and C2 occur does not have to be fixed. It can depend on the value of a counter field. Suppose field B is this counter field. In the case shown above, the value of field B is 2, since C1 and C2 occur twice. The value of field B in the next record can be 7, 1, 0, or any other number you choose, and fields C1 and C2 occur that number of times.

The number of times fields C1 and C2 occur can also be variable. In this case, everything after fields A and B is assumed to be a series of C1s and C2s, alternating to the end of the record.

Describe these multiply occurring fields by placing them in a separate segment. Fields A and B are placed in the root segment. Fields C1 and C2, which occur multiply in relation to A and B, are placed in a descendant segment. You use an additional segment attribute, the OCCURS attribute, to specify that these segments represent multiply occurring fields. In certain cases, you may also need a second attribute, called the POSITION attribute.

Using the OCCURS Attribute

The OCCURS attribute is an optional segment attribute used to describe records containing repeating fields or groups of fields. Define such records by describing the singly occurring fields in one segment, and the multiply occurring fields in a descendant segment. The OCCURS attribute appears in the declaration for the descendant segment.

You can have several sets of repeating fields in your data structure. Describe each of these sets of fields as a separate segment in your data source description. Sets of repeating fields can be divided into two basic types: parallel and nested.

Specify a Repeating Field

```
OCCURS = occurstype
```

Possible values for *occurstype* are:

n

Is an integer value showing the number of occurrences (from 1 to 4095).

fieldname

Names a field in the parent segment or a virtual field in an ancestor segment whose integer value contains the number of occurrences of the descendant segment. Note that if you use a virtual field as the OCCURS value, it cannot be redefined inside or outside of the Master File.

VARIABLE

Indicates that the number of occurrences varies from record to record. The number of occurrences is computed from the record length (for example, if the field lengths for the segment add up to 40, and 120 characters are read in, it means there are three occurrences).

Place the OCCURS attribute in your segment declaration after the PARENT attribute.

When different types of records are combined in one data source, each record type can contain only one segment defined as OCCURS=VARIABLE. It may have OCCURS descendants (if it contains a nested group), but it may not be followed by any other segment with the same parent. There can be no other segments to its right in the hierarchical data structure. This restriction is necessary to ensure that data in the record is interpreted unambiguously.

Using the OCCURS Attribute

Consider the following simple data structure:



You have two occurrences of fields C1 and C2 for every one occurrence of fields A and B. Thus, to describe this data source, you place fields A and B in the root segment, and fields C1 and C2 in a descendant segment, as shown here:

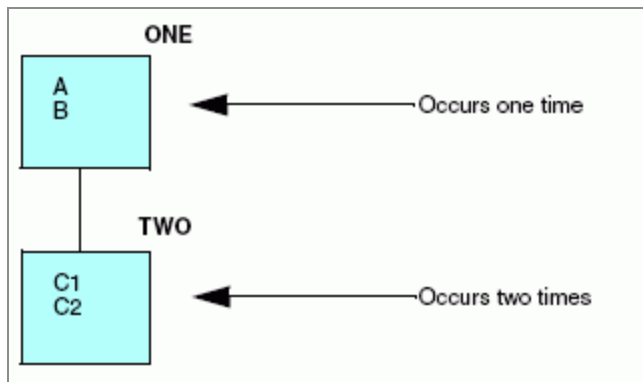

Describe this data source as follows:

```
FILENAME = EXAMPLE1, SUFFIX = FIX, $
SEGNAME = ONE, SEGTYPE=S0, $
  FIELDNAME = A, ALIAS=, USAGE = A2, ACTUAL = A2, $
  FIELDNAME = B, ALIAS=, USAGE = A1, ACTUAL = A1, $
SEGNAME = TWO, PARENT = ONE, OCCURS = 2, SEGTYPE=S0, $
  FIELDNAME = C1, ALIAS=, USAGE = I4, ACTUAL = I2, $
  FIELDNAME = C2, ALIAS=, USAGE = I4, ACTUAL = I2, $
```

Describing a Parallel Set of Repeating Fields

Parallel sets of repeating fields are those that have nothing to do with one another (that is, they have no parent-child or logical relationship). Consider the following data structure:

A 1	A 2	B 1	B 2	B 1	B 2	C 1	C 2	C 1	C 2	C 1	C 2
--------	--------	--------	--------	--------	--------	--------	--------	--------	--------	--------	--------

In this example, fields B1 and B2 and fields C1 and C2 repeat within the record. The number of times that fields B1 and B2 occur has nothing to do with the number of times fields C1 and C2 occur. Fields B1 and B2 and fields C1 and C2 are parallel sets of repeating fields. They should be described in the data source description as children of the same parent, the segment that contains fields A1 and A2.

The following data structure reflects their relationship:

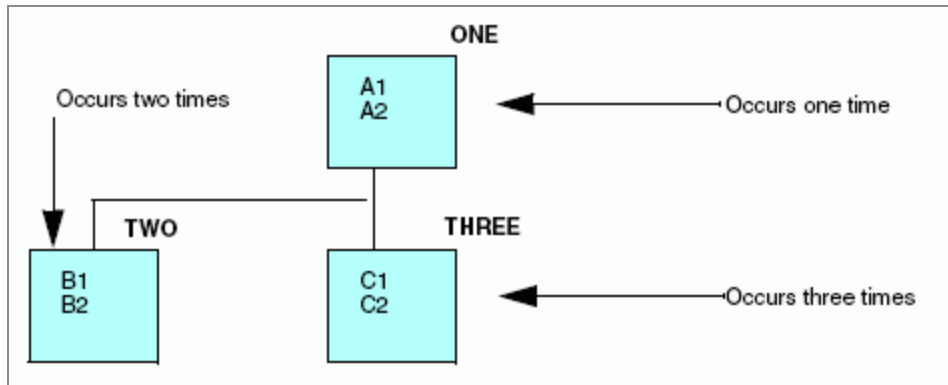

Describing a Nested Set of Repeating Fields

Nested sets of repeating fields are those whose occurrence depends on one another in some way. Consider the following data structure:

A 1	A 2	B 1	B 2	C 1	C 1	B 1	B 2	C 1	C 1	C 1
--------	--------	--------	--------	--------	--------	--------	--------	--------	--------	--------

In this example, field C1 only occurs after fields B1 and B2 occur once. It occurs varying numbers of times, recorded by a counter field, B2. There is not a set of occurrences of C1 which is not preceded by an occurrence of fields B1 and B2. Fields B1, B2, and C1 are a nested set of repeating fields.

These repeating fields can be represented by the following data structure:

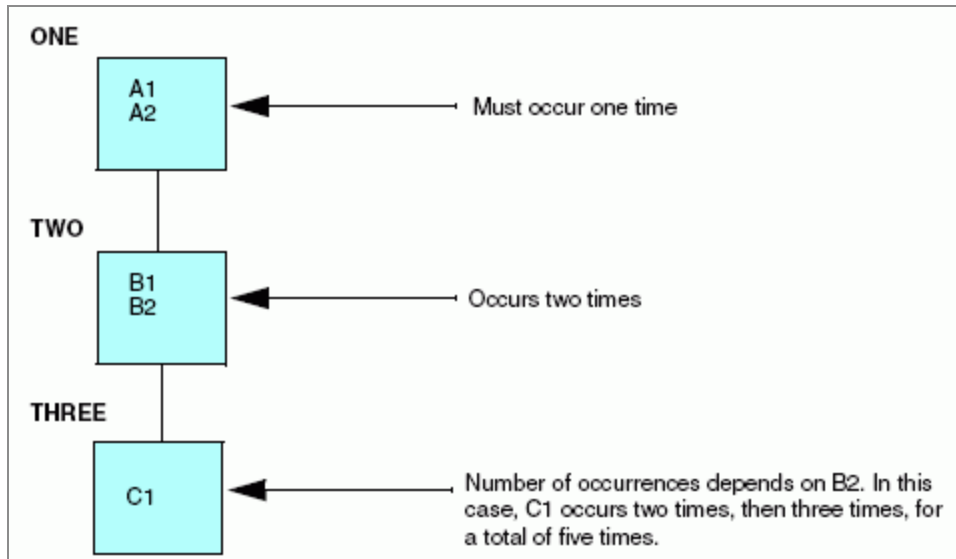

Since field C1 repeats with relation to fields B1 and B2, which repeat in relation to fields A1 and A2, field C1 is described as a separate, descendant segment of Segment TWO, which is in turn a descendant of Segment ONE.

Describing Parallel and Nested Repeating Fields

The following data structure contains both nested and parallel sets of repeating fields.

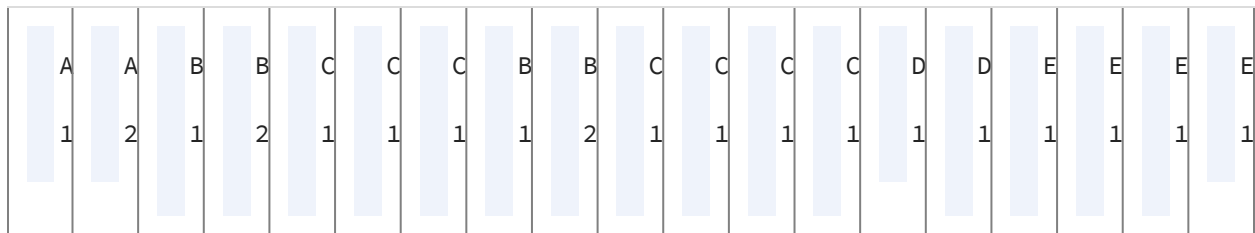

It produces the following data structure:

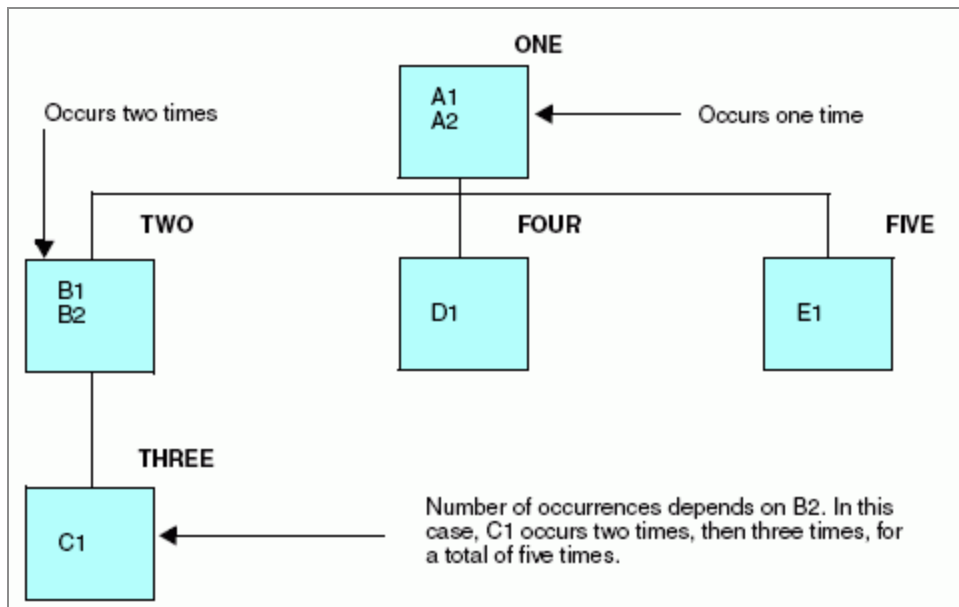

Describe this data source as follows. Notice that the assignment of the PARENT attributes shows you how the occurrences are nested.

```

FILENAME = EXAMPLE3, SUFFIX = FIX,$
SEGNAME = ONE,   SEGTYPE=S0,$
  FIELDNAME = A1 ,ALIAS= ,ACTUAL = A1  ,USAGE = A1  ,$
  FIELDNAME = A2 ,ALIAS= ,ACTUAL = I1  ,USAGE = I1  ,$
SEGNAME = TWO,   SEGTYPE=S0, PARENT = ONE, OCCURS = 2  ,$
  FIELDNAME = B1 ,ALIAS= ,ACTUAL = A15 ,USAGE = A15 ,$
  FIELDNAME = B2 ,ALIAS= ,ACTUAL = I1  ,USAGE = I1  ,$
SEGNAME = THREE, SEGTYPE=S0, PARENT = TWO, OCCURS = B2 ,$
  FIELDNAME = C1 ,ALIAS= ,ACTUAL = A25 ,USAGE = A25 ,$
SEGNAME = FOUR,  SEGTYPE=S0, PARENT = ONE, OCCURS = A2 ,$
  FIELDNAME = D1 ,ALIAS= ,ACTUAL = A15 ,USAGE = A15 ,$
SEGNAME = FIVE,  SEGTYPE=S0, PARENT = ONE, OCCURS = VARIABLE,$
  FIELDNAME = E1 ,ALIAS= ,ACTUAL = A5  ,USAGE = A5  ,$

```

i Note:

- Segments ONE, TWO, and THREE represent a nested group of repeating segments. Fields B1 and B2 occur a fixed number of times, so OCCURS equals 2. Field C1 occurs a certain number of times within each occurrence of fields B1 and B2. The number of times C1 occurs is determined by the value of field B2, which is a counter. In this case, its value is 3 for the first occurrence of Segment TWO and 4 for the second occurrence.
- Segments FOUR and FIVE consist of fields that repeat independently within the parent segment. They have no relationship to each other or to Segment TWO except their common parent, so they represent a parallel group of repeating segments.
- As in the case of Segment THREE, the number of times Segment FOUR occurs is determined by a counter in its parent, A2. In this case, the value of A2 is two.
- The number of times Segment FIVE occurs is variable. This means that all the rest of the fields in the record (all those to the right of the first occurrence of E1) are read as recurrences of field E1. To ensure that data in the record is interpreted unambiguously, a segment defined as OCCURS=VARIABLE must be at the end of the record. In a data structure diagram, it is the rightmost segment. Note that there can be only one segment defined as OCCURS=VARIABLE for each record type.

Using the POSITION Attribute

The POSITION attribute is an optional attribute used to describe a structure in which multiply occurring fields with an established number of occurrences are located in the middle of the record. You describe the data source as a hierarchical structure, made up of a parent segment and at least one child segment that contains the multiply occurring fields. The parent segment is made up of whatever singly occurring fields are in the record, as well as one or more alphanumeric fields that appear where the multiply occurring fields appear in the record. The alphanumeric field may be a dummy field that is the exact length of the combined multiply occurring fields. For example, if you have four occurrences of an eight-character field, the length of the field in the parent segment is 32 characters.

You can also use the POSITION attribute to redescribe fields with SEGTYPE=U. For more information, see [Redefining a Field in a Non-FOCUS Data Source](#).

Specify the Position of a Repeating Field

The POSITION attribute is described in the child segment. It gives the name of the field in the parent segment that specifies the starting position and overall length of the multiply occurring fields. The syntax of the POSITION attribute is

```
POSITION = fieldname
```

where:

fieldname

Is the name of the field in the parent segment that defines the starting position of the multiple field occurrences.

Specifying the Position of a Repeating Field

Consider the following data structure:

A1	Q1	Q1	Q1	Q1	A2	A3	A4
----	----	----	----	----	----	----	----

In this example, field Q1 repeats four times in the middle of the record. When you describe this structure, you specify a field or fields that occupy the position of the four Q1 fields in the record. You then assign the actual Q1 fields to a multiply occurring descendant segment. The POSITION attribute, specified in the descendant segment, gives the name of the field in the parent segment that identifies the starting position and overall length of the Q fields.

Use the following Master File to describe this structure:

```
FILENAME = EXAMPLE3, SUFFIX = FIX,$
SEGNAME = ONE, SEGTYPE=S0,$
  FIELDNAME = A1 ,ALIAS= ,USAGE = A14 ,ACTUAL = A14 ,,$
  FIELDNAME = QFIL ,ALIAS= ,USAGE = A32 ,ACTUAL = A32 ,,$
  FIELDNAME = A2 ,ALIAS= ,USAGE = I2 ,ACTUAL = I2 ,,$
  FIELDNAME = A3 ,ALIAS= ,USAGE = A10 ,ACTUAL = A10 ,,$
  FIELDNAME = A4 ,ALIAS= ,USAGE = A15 ,ACTUAL = A15 ,,$
```



```
SEGNAME = TWO, SEGTYPE=S0, PARENT = ONE, POSITION = QFIL, OCCURS = 4 , $
FIELDNAME = Q1 , ALIAS= , USAGE = D8 , ACTUAL = D8 , $
```

This produces the following structure:

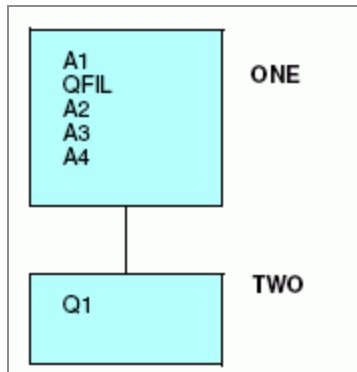

If the total length of the multiply occurring fields is longer than 4095, you can use a filler field after the dummy field to make up the remaining length. This is required, because the format of an alphanumeric field cannot exceed 4095 bytes.

Notice that this structure works only if you have a fixed number of occurrences of the repeating field. This means the OCCURS attribute of the descendant segment must be of the type OCCURS=*n*. OCCURS=*fieldname* or OCCURS=VARIABLE does not work.

Specifying the ORDER Field

In an OCCURS segment, the order of the data may be significant. For example, the values may represent monthly or quarterly data, but the record itself may not explicitly specify the month or quarter to which the data applies.

To associate a sequence number with each occurrence of the field, you may define an internal counter field in any OCCURS segment. A value is automatically supplied that defines the sequence number of each repeating group.

Specify the Sequence of a Repeating Field

The syntax rules for an ORDER field are:

- It must be the last field described in an OCCURS segment.

- The field name is arbitrary.
- The ALIAS is ORDER.
- The USAGE is In, with any appropriate edit options.
- The ACTUAL is I4.

Order values are 1, 2, 3, and so on, within each occurrence of the segment. The value is assigned prior to any selection tests that might accept or reject the record, and so it can be used in a selection test.

Using the ORDER Attribute in a Selection Test

The following declaration assigns ACT_MONTH as the ORDER field:

```
FIELD = ACT_MONTH, ALIAS = ORDER, USAGE = I2MT, ACTUAL = I4, $
```

The following WHERE test obtains data for only the month of June:

```
SUM AMOUNT...  
WHERE ACT_MONTH IS 6
```

The ORDER field is a virtual field used internally. It does not alter the logical record length (LRECL) of the data source being accessed.

Redefining a Field in a Non-FOCUS Data Source

Redefining record fields in non-FOCUS data sources is supported. This enables you to describe a field with an alternate layout.

Within the Master File, the redefined fields must be described in a separate unique segment (SEGTYPE=U) using the POSITION=fieldname and OCCURS=1 attributes.

The redefined fields can have any user-defined name.

Redefine a Field

```
SEGNAME = segname, SEGTYPE = U, PARENT = parentseg,
OCCURS = 1, POSITION = fieldname,$
```

where:

segname

Is the name of the segment.

parentseg

Is the name of the parent segment.

fieldname

Is the name of the first field being redefined. Using the unique segment with redefined fields helps avoid problems with multipath reporting.

A one-to-one relationship forms between the parent record and the redefined segment.

Redefining a VSAM Structure

The following example illustrates the redefinition of the VSAM structure described in the COBOL file description, where the COBOL FD is:

```
01 ALLFIELDS
  02 FLD1    PIC X(4)          - this describes alpha/numeric data
  02 FLD2    PIC X(4)          - this describes numeric data
  02 RFLD1   PIC 9(5)V99 COMP-3 REDEFINES FLD2
  02 FLD3    PIC X(8)          - this describes alpha/numeric data

FILE = REDEF, SUFFIX = VSAM,$
SEGNAME = ONE, SEGTYPE = S0,$
GROUP = RKEY, ALIAS = KEY, USAGE = A4 ,ACTUAL = A4 ,$
  FIELDNAME = FLD1,, USAGE = A4 ,ACTUAL = A4 ,$
  FIELDNAME = FLD2,, USAGE = A4 ,ACTUAL = A4 ,$
  FIELDNAME = FLD3,, USAGE = A8 ,ACTUAL = A8 ,$
SEGNAME = TWO, SEGTYPE = U, POSITION = FLD2,OCCURS = 1, PARENT = ONE ,$
  FIELDNAME = RFLD1,, USAGE = P8.2 ,ACTUAL = Z4 ,$
```

Special Considerations for Redefining a Field

- Redefinition is a read-only feature and is used only for presenting an alternate view of the data. It is not used for changing the format of the data.
- For non-alphanumeric fields, you must know your data. Attempts to print numeric fields that contain alphanumeric data produce data exceptions or errors in converting values. It is recommended that the first definition always be alphanumeric to avoid conversion errors.
- More than one field can be redefined in a segment.
- Redefines are supported only for IDMS, IMS, VSAM, DB2, and FIX data sources.

Extra-Large Record Length Support

MAXLRECL indicates the largest actual file record length that FOCUS can read. The limit for MAXLRECL is 65536 bytes, allowing the user to read a record twice as large as the length of the internal matrix, which is limited to 32K.

If the Master File describes a data source with OCCURS segments, and if the longest single record in the data source is larger than 16K bytes, it is necessary to specify a larger record size in advance.

Define the Maximum Record Length

```
SET MAXLRECL = nnnnn
```

where:

nnnnn

Is an integer value up to 65536.

For example, SET MAXLRECL=12000 allows handling of records that are 12000 bytes long. After you have entered the SET MAXLRECL command, you can obtain the current value of the MAXLRECL parameter by using the ? SET MAXLRECL command.

If the actual record length is longer than specified, retrieval halts and the actual record length appear in hexadecimal notation.

Describing Multiple Record Types

Fixed-format sequential, VSAM, and ISAM data sources can contain more than one type of record. When they do, they can be structured in one of two ways:

- A positional relationship may exist between the various record types, with a record of one type being followed by one or more records containing detailed information about the first record.

If a positional relationship exists between the various record types, with a parent record of one type followed by one or more child records containing detail information about the parent, you describe the structure by defining the parent as the root, and the detail segments as descendants.

Some VSAM and ISAM data sources are structured so that descendant records relate to each other through concatenating key fields. That is, the key fields of a parent record serve as the first part of the key of a child record. In such cases, the segment key fields must be described using a GROUP declaration. Each segment GROUP key fields consist of the renamed key fields from the parent segment plus the unique key field from the child record.

- The records have no meaningful positional relationship, and records of varying types exist independently of each other in the data source.

If the records have no meaningful positional relationship, you have to provide some means for interpreting the type of record that has been read. Do this by creating a dummy root segment for the records.

In order to describe sequential data sources with several types of records, regardless of whether they are logically related, use the PARENT segment attribute and the RECTYPE field attribute. Any complex sequential data source is described as a multi-segment structure.

Key-sequenced VSAM and complex ISAM data sources also use the RECTYPE attribute to distinguish various record types within the data source.

A parent does not always share its RECTYPE with its descendants. It may share some other identifying piece of information, such as the PUBNO in the example. This is the field that should be included in the parent key, as well as the keys of all of its descendants, to relate them.

When using the RECTYPE attribute in VSAM or ISAM data sources with group keys, the RECTYPE field can be part of the segment group key only when it belongs to a segment that has no descendants, or to a segment whose descendants are described with an OCCURS attribute. In [Describing VSAM Positionally Related Records](#), the RECTYPE field is added to the group key in the SERIANO segment, the lowest descendant segment in the chain.

SEGTYPE Attributes With RECTYPE Fields

It is always assumed that at least one record for each SEGTYPE will exist in positionally related types. The SEGTYPE is usually S0.

In the case where there is a unique relationship between the parent RECTYPE and a child RECTYPE, and only one record of the child is expected for a given parent, a SEGTYPE of U may be used. This will have the effect of making the second segment be a logical extension of the parent. An example is when a given bookcode has only one book name but might have multiple editions. Then, edition information can be sorted by BOOKCODE or BOOKNAME.

i Note: When specifying SEGTYPE U for this type of file, the rule is that there must be an instance of the child for each parent instance. If the child instance is missing, the results are unpredictable and will not be defaulted to blanks.

Describing a RECTYPE Field

When a data source contains multiple record types, there must be a field in the records themselves that can be used to differentiate between the record types. You can find information on this field in your existing description of the data source (for example, a COBOL FD statement). This field must appear in the same physical location of each record. For example, columns 79 and 80 can contain a different two-digit code for each unique record type. Describe this identifying field with the field name RECTYPE.

Another technique for redefining the parts of records is to use the MAPFIELD and MAPVALUE attributes described in [Describing a Repeating Group Using MAPFIELD](#).

Specify a Record Type Field

The RECTYPE field must fall in the same physical location of each record in the data source, or the record is ignored. The syntax to describe the RECTYPE field is

```
FIELDNAME = RECTYPE, ALIAS = value, USAGE = format, ACTUAL = format,  
ACCEPT = {list|range} , $
```

where:

value

Is the record type in alphanumeric format, if an ACCEPT list is not specified. If there is an ACCEPT list, this can be any value.

format

Is the data type of the field. In addition to RECTYPE fields in alphanumeric format, RECTYPE fields in packed and integer formats (formats P and I) are supported. Possible values are:

An (where n is 1-4095) indicates character data, including letters, digits, and other characters.

In indicates ACTUAL (internal) format binary integers:

- I1 = single-byte binary integer.
- I2 = half-word binary integer (2 bytes).
- I4 = full-word binary integer (4 bytes).

The USAGE format can be I1 through I9, depending on the magnitude of the ACTUAL format.

Pn (where n is 1-16) indicates packed decimal ACTUAL (internal) format. *n* is the number of bytes, each of which contains two digits, except for the last byte which contains a digit and the sign. For example, P6 means 11 digits plus a sign.

If the field contains an assumed decimal point, represent the field with a USAGE format of *Pm.n*, where *m* is the total number of digits, and *n* is the number of decimal places. Thus, P11.1 means an eleven-digit number with one decimal place.

list

Is a list of one or more lines of specific RECTYPE values for records that have the same segment layout. The maximum number of characters allowed in the list is 255. Separate each item in the list with either a blank or the keyword OR. If the list contains embedded blanks or commas, it must be enclosed within single quotation marks. The list may contain a single RECTYPE value. For example:

```
FIELDNAME = RECTYPE, ALIAS = TYPEABC, USAGE = A1, ACTUAL = A1,
ACCEPT = A OR B OR C, $
```

range

Is a range of one or more lines of RECTYPE values for records that have the same segment layout. The maximum number of characters allowed in the range is 255. If the range contains embedded blanks or commas, it must be enclosed within single quotation marks.

To specify a range of values, include the lowest value, the keyword TO, and the highest value, in that order. For example:

```
FIELDNAME = RECTYPE, ALIAS = ACCTREC, USAGE = P3, ACTUAL = P2,
ACCEPT = 100 TO 200, $
```

Specifying the RECTYPE Field

The following field description is of a one-byte packed RECTYPE field containing the value 1:

```
FIELD = RECTYPE, ALIAS = 1, USAGE = P1, ACTUAL = P1, $
```

The following field description is of a three-byte alphanumeric RECTYPE field containing the value A34:

```
FIELD = RECTYPE, ALIAS = A34, USAGE = A3, ACTUAL = A3, $
```

Describing Positionally Related Records

The following diagram shows a more complex version of the library data source:

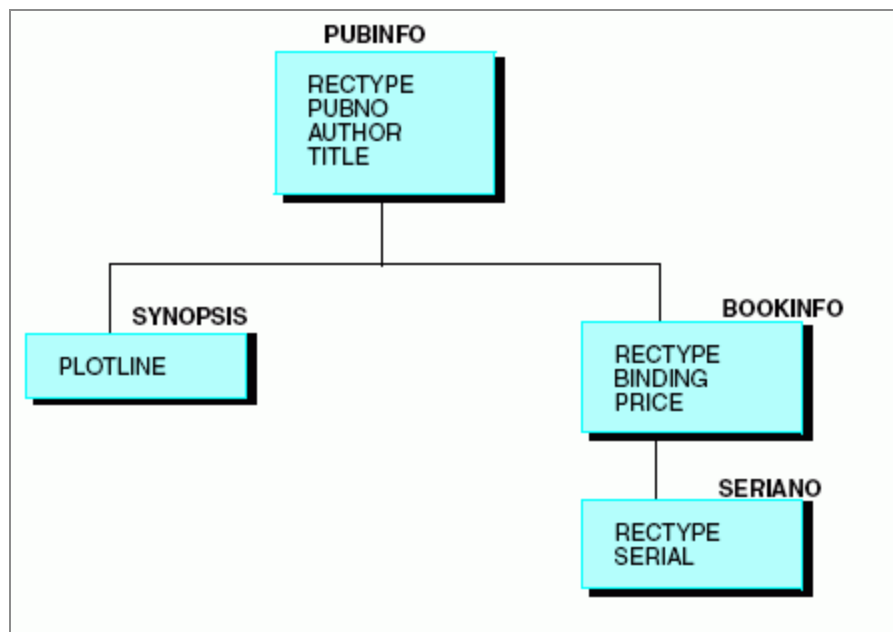

Information that is common to all copies of a given book (the identifying number, the author name, and its title) has the same record type. All of this information is assigned to the root segment in the Master File. The synopsis is common to all copies of a given book, but in this data source it is described as a series of repeating fields of ten characters each, in order to save space.

The synopsis is assigned to its own subordinate segment with an attribute of OCCURS=VARIABLE in the Master File. Although there are segments in the diagram to the right of the OCCURS=VARIABLE segment, OCCURS=VARIABLE is the rightmost segment within its own record type. Only segments with a RECTYPE that is different from the OCCURS=VARIABLE segment can appear to its right in the structure. Note also that the OCCURS=VARIABLE segment does not have a RECTYPE. This is because it is part of the same record as its parent segment.

Binding and price can vary among copies of a given title. For instance, the library may have two different versions of *Pamela*, one a paperback costing \$7.95, the other a hardcover costing \$15.50. These two fields are of a second record type, and are assigned to a descendant segment in the Master File.

Finally, every copy of the book in the library has its own identifying serial number, which is described in a field of record type S. In the Master File, this information is assigned to a segment that is a child of the segment containing the binding and price information.

Use the following Master File to describe this data source:

```

FILENAME = LIBRARY2, SUFFIX = FIX,$
SEGNAME = PUBINFO, SEGTYPE = S0,$
  FIELDNAME = RECTYPE ,ALIAS = P      ,USAGE = A1      ,ACTUAL = A1  ,$
  FIELDNAME = PUBNO   ,ALIAS = PN     ,USAGE = A10    ,ACTUAL = A10 ,$
  FIELDNAME = AUTHOR  ,ALIAS = AT     ,USAGE = A25    ,ACTUAL = A25 ,$
  FIELDNAME = TITLE   ,ALIAS = TL     ,USAGE = A50    ,ACTUAL = A50 ,$
SEGNAME = SYNOPSIS, PARENT = PUBINFO, OCCURS = VARIABLE, SEGTYPE =
S0,$
  FIELDNAME = PLOTLINE ,ALIAS = PLOTL ,USAGE = A10    ,ACTUAL = A10 ,$
SEGNAME = BOOKINFO, PARENT = PUBINFO, SEGTYPE = S0,$
  FIELDNAME = RECTYPE ,ALIAS = B      ,USAGE = A1      ,ACTUAL = A1  ,$
  FIELDNAME = BINDING ,ALIAS = BI     ,USAGE = A1      ,ACTUAL = A1  ,$
  FIELDNAME = PRICE   ,ALIAS = PR     ,USAGE = D8.2N   ,ACTUAL = D8  ,$
SEGNAME = SERIANO, PARENT = BOOKINFO, SEGTYPE = S0,$
  FIELDNAME = RECTYPE ,ALIAS = S      ,USAGE = A1      ,ACTUAL = A1  ,$
  FIELDNAME = SERIAL  ,ALIAS = SN     ,USAGE = A15     ,ACTUAL = A15 ,$

```

Note that each segment, except OCCURS, contains a field named RECTYPE and that the ALIAS for the field contains a unique value for each segment (P, B, and S). If there is a record in this data source with a RECTYPE other than P, B, or S, the record is ignored. The RECTYPE field must fall in the same physical location in each record.

Ordering of Records in the Data Source

Physical order determines parent/child relationships in sequential records. Every parent record does not need descendants. Specify how you want data in missing segment instances handled in your reports by using the SET command to change the ALL parameter. The SET command is described in the *Developing Applications* manual.

In the example in [Describing Positionally Related Records](#), if the first record in the data source is not a PUBINFO record, the record is considered to be a child without a parent. Any information allotted to the SYNOPSIS segment appears in the PUBINFO record. The next record may be a BOOKINFO or even another PUBINFO (in which case the first PUBINFO is assumed to have no descendants). Any SERIANO records are assumed to be descendants of the previous BOOKINFO record. If a SERIANO record follows a PUBINFO record with no intervening BOOKINFO, it is treated as if it has no parent.

Describing VSAM Positionally Related Records

Consider the following VSAM data source that contains three types of records. The ROOT records have a key that consists of the publisher number, PUBNO. The BOOKINFO segment has a key that consists of that same publisher number, plus a hard-cover or soft-cover indicator, BINDING. The SERIANO segment key consists of the first two elements, plus a record type field, RECTYPE.

```

FILENAME = LIBRARY6, SUFFIX = VSAM,$
SEGNAME = ROOT, SEGTYPE = S0,$
  GROUP=PUBKEY      ,ALIAS=KEY      ,USAGE=A10      ,ACTUAL=A10      ,$
  FIELDNAME=PUBNO   ,ALIAS=PN      ,USAGE=A10      ,ACTUAL=A10      ,$
  FIELDNAME=FILLER  ,ALIAS=        ,USAGE=A1       ,ACTUAL=A1       ,$
  FIELDNAME=RECTYPE ,ALIAS=1       ,USAGE=A1       ,ACTUAL=A1       ,$
  FIELDNAME=AUTHOR  ,ALIAS=AT      ,USAGE=A25      ,ACTUAL=A25      ,$
  FIELDNAME=TITLE   ,ALIAS=TL      ,USAGE=A50      ,ACTUAL=A50      ,$
SEGNAME=BOOKINFO, PARENT=ROOT, SEGTYPE=S0,$
  GROUP=BOINKEY     ,ALIAS=KEY     ,USAGE=A11     ,ACTUAL=A11     ,$
  FIELDNAME=PUBNO1  ,ALIAS=P1     ,USAGE=A10     ,ACTUAL=A10     ,$
  FIELDNAME=BINDING ,ALIAS=BI     ,USAGE=A1     ,ACTUAL=A1     ,$
  FIELDNAME=RECTYPE ,ALIAS=2     ,USAGE=A1     ,ACTUAL=A1     ,$
  FIELDNAME=PRICE   ,ALIAS=PR     ,USAGE=D8.2N   ,ACTUAL=D8     ,$
SEGNAME=SERIANO, PARENT=BOOKINFO, SEGTYPE=S0,$
  GROUP=SERIKEY     ,ALIAS=KEY     ,USAGE=A12     ,ACTUAL=A12     ,$
  FIELDNAME=PUBNO2  ,ALIAS=P2     ,USAGE=A10     ,ACTUAL=A10     ,$
  FIELDNAME=BINDING1 ,ALIAS=B1     ,USAGE=A1     ,ACTUAL=A1     ,$
  FIELDNAME=RECTYPE ,ALIAS=3     ,USAGE=A1     ,ACTUAL=A1     ,$
  FIELDNAME=SERIAL  ,ALIAS=SN     ,USAGE=A15     ,ACTUAL=A15     ,$
SEGNAME=SYNOPSIS, PARENT=ROOT, SEGTYPE=S0, OCCURS=VARIABLE,$
  FIELDNAME=PLOTLINE ,ALIAS=POTL   ,USAGE=A10     ,ACTUAL=A10     ,$

```

Notice that the length of the key fields specified in the USAGE and ACTUAL attributes of a GROUP declaration is the length of the key fields from the parent segments, plus the length of the added field of the child segment (RECTYPE field). In the example above, the length of the GROUP key SERIKEY equals the length of PUBNO2 and BINDING1, the group key from the parent segment, plus the length of RECTYPE, the field added to the group key in the child segment. The length of the key increases as you traverse the structure.

i Note: Each segment key describes as much of the true key as needed to find the next instance of that segment.

In the sample data source, the repetition of the publisher number as PUBNO1 and PUBNO2 in the descendant segments interrelates the three types of records.

The data source can be diagrammed as the following structure:

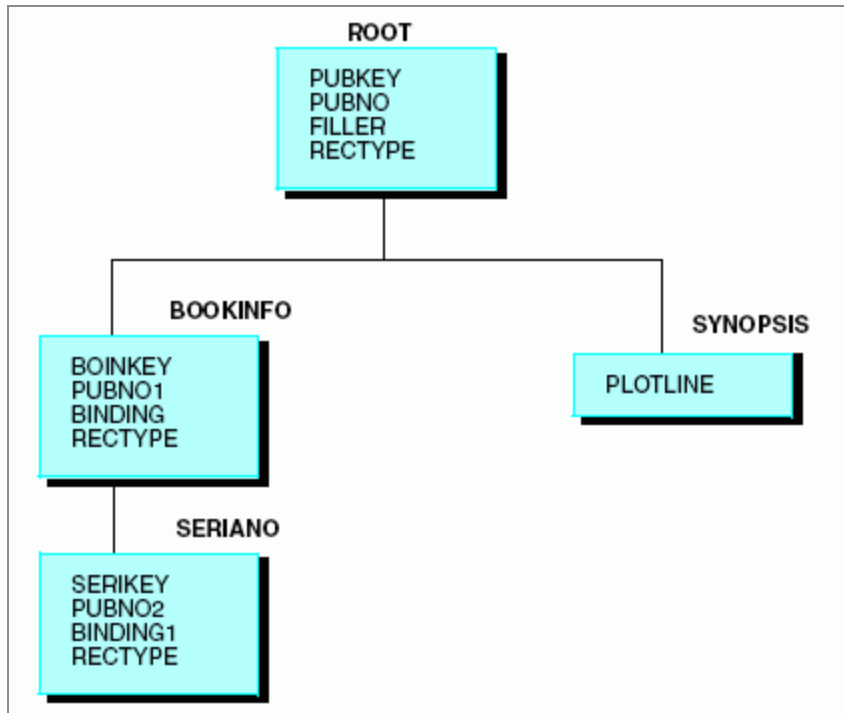

A typical query may request information on price and call numbers for a specific publisher number:

```

PRINT PRICE AND SERIAL BY PUBNO
IF PUBNO EQ 1234567890 OR 9876054321
  
```

Since PUBNO is part of the key, retrieval can occur quickly, and the processing continues. To further speed retrieval, add search criteria based on the BINDING field, which is also part of the key.

Describing Unrelated Records

Some VSAM and ISAM data sources do not have records that are related to one another. That is, the VSAM or ISAM key of one record type is independent of the keys of other record types. To describe data sources with unrelated records, define a dummy root segment for the record types. The following rules apply to the dummy root segment:

- The name of the root segment must be DUMMY.
- It must have only one field with a blank name and alias.
- The USAGE and ACTUAL attributes must both be A1.

All other non-repeating segments must point to the dummy root as their parent. Except for the root, all non-repeating segments must have a RECTYPE and a PARENT attribute and describe the full VSAM/ISAM key. If the data source does not have a key, the group should not be described. RECTYPES may be anywhere in the record.

Describing Unrelated Records Using a Dummy Root Segment

The library data source has three types of records: book information, magazine information, and newspaper information. Since these three record types have nothing in common, they cannot be described as parent records followed by detail records.

The data source can look like this:



A structure such as the following can also describe this data source:

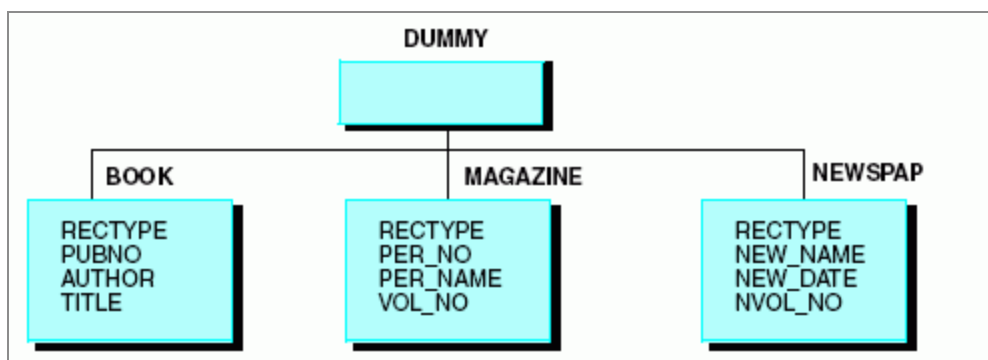

The Master File for the structure in this example is:

```
FILENAME = LIBRARY3, SUFFIX = FIX,$
SEGMENT = DUMMY, SEGTYPE = S0,$
```

```

FIELDNAME=          ,ALIAS=          ,USAGE = A1      ,ACTUAL = A1    , $
SEGMENT = BOOK, PARENT = DUMMY, SEGTYPE = S0,$
FIELDNAME = RECTYPE ,ALIAS = B   ,USAGE = A1      ,ACTUAL = A1    , $
FIELDNAME = PUBNO   ,ALIAS = PN  ,USAGE = A10     ,ACTUAL = A10   , $
FIELDNAME = AUTHOR  ,ALIAS = AT  ,USAGE = A25     ,ACTUAL = A25   , $
FIELDNAME = TITLE   ,ALIAS = TL  ,USAGE = A50     ,ACTUAL = A50   , $
FIELDNAME = BINDING ,ALIAS = BI  ,USAGE = A1      ,ACTUAL = A1    , $
FIELDNAME = PRICE   ,ALIAS = PR  ,USAGE = D8.2N   ,ACTUAL = D8    , $
FIELDNAME = SERIAL  ,ALIAS = SN  ,USAGE = A15     ,ACTUAL = A15   , $
FIELDNAME = SYNOPSIS ,ALIAS = SY  ,USAGE = A150    ,ACTUAL = A150  , $
SEGMENT = MAGAZINE, PARENT = DUMMY, SEGTYPE = S0,$
FIELDNAME = RECTYPE ,ALIAS = M   ,USAGE = A1      ,ACTUAL = A1    , $
FIELDNAME = PER_NO  ,ALIAS = PN  ,USAGE = A10     ,ACTUAL = A10   , $
FIELDNAME = PER_NAME ,ALIAS = NA  ,USAGE = A50     ,ACTUAL = A50   , $
FIELDNAME = VOL_NO  ,ALIAS = VN  ,USAGE = I2      ,ACTUAL = I2    , $
FIELDNAME = ISSUE_NO ,ALIAS = IN  ,USAGE = I2      ,ACTUAL = I2    , $
FIELDNAME = PER_DATE ,ALIAS = DT  ,USAGE = I6MDY   ,ACTUAL = I6    , $
SEGMENT = NEWSPAP, PARENT = DUMMY, SEGTYPE = S0,$
FIELDNAME = RECTYPE ,ALIAS = N   ,USAGE = A1      ,ACTUAL = A1    , $
FIELDNAME = NEW_NAME ,ALIAS = NN  ,USAGE = A50     ,ACTUAL = A50   , $
FIELDNAME = NEW_DATE ,ALIAS = ND  ,USAGE = I6MDY   ,ACTUAL = I6    , $
FIELDNAME = NVOL_NO  ,ALIAS = NV  ,USAGE = I2      ,ACTUAL = I2    , $
FIELDNAME = ISSUE    ,ALIAS = NI  ,USAGE = I2      ,ACTUAL = I2    , $

```

Describing a VSAM Data Source With Unrelated Records

Consider another VSAM data source containing information on the library. This data source has three types of records: book information, magazine information, and newspaper information.

There are two possible structures:

The RECTYPE is the beginning of the key. The key structure is:

RECTYPE B	Book Code
RECTYPE M	Magazine Code
RECTYPE N	Newspaper Code

The sequence of records is:

Book
Book
Magazine
Magazine
Newspaper
Newspaper

Note the difference between the use of the RECTYPE here and its use when the records are positionally related. In this case, the codes are unrelated and the database designer has chosen to accumulate the records by type first (all the book information together, all the magazine information together, and all the newspaper information together), so the RECTYPE may be the initial part of the key.

The RECTYPE is not in the beginning of the key or is outside of the key.

The key structure is:

Book Code
Magazine Code
Newspaper Code

The sequence of record types in the data source can be arbitrary.

Both types of file structure can be represented by the following:

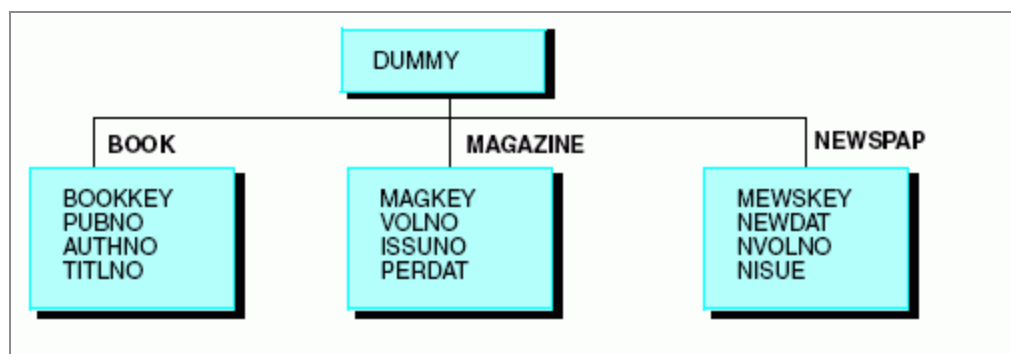

Describing a Key and a Record Type for a VSAM Data Source With Unrelated Records

```

FILE=LIBRARY7, SUFFIX=VSAM,$
SEGMENT=DUMMY,$
FIELDNAME=          ,ALIAS=          ,USAGE=A1    ,ACTUAL=A1    ,$
SEGMENT=BOOK,      PARENT=DUMMY, SEGTYPE=S0,$
GROUP=BOOKKEY      ,ALIAS=KEY   ,USAGE=A11   ,ACTUAL=A11   ,$
FIELDNAME=PUBNO    ,ALIAS=PN    ,USAGE=A3    ,ACTUAL=A3    ,$
FIELDNAME=AUTHNO   ,ALIAS=AN    ,USAGE=A3    ,ACTUAL=A3    ,$
FIELDNAME=TITLNO   ,ALIAS=TN    ,USAGE=A4    ,ACTUAL=A4    ,$
FIELDNAME=RECTYPE  ,ALIAS=B     ,USAGE=A1    ,ACTUAL=A1    ,$
FIELDNAME=AUTHOR   ,ALIAS=AT    ,USAGE=A25   ,ACTUAL=A25   ,$
FIELDNAME=TITLE    ,ALIAS=TL    ,USAGE=A50   ,ACTUAL=A50   ,$
FIELDNAME=BINDING  ,ALIAS=BI    ,USAGE=A1    ,ACTUAL=A1    ,$
FIELDNAME=PRICE    ,ALIAS=PR    ,USAGE=D8.2N ,ACTUAL=D8    ,$
FIELDNAME=SERIAL   ,ALIAS=SN    ,USAGE=A15   ,ACTUAL=A15   ,$
FIELDNAME=SYNOPSIS ,ALIAS=SY    ,USAGE=A150  ,ACTUAL=A150  ,$
SEGMENT=MAGAZINE, PARENT=DUMMY, SEGTYPE=S0,$
GROUP=MAGKEY       ,ALIAS=KEY   ,USAGE=A11   ,ACTUAL=A11   ,$
FIELDNAME=VOLNO    ,ALIAS=VN    ,USAGE=A2    ,ACTUAL=A2    ,$
FIELDNAME=ISSUNO   ,ALIAS=IN    ,USAGE=A2    ,ACTUAL=A2    ,$
FIELDNAME=PERDAT   ,ALIAS=DT    ,USAGE=A6    ,ACTUAL=A6    ,$
FIELDNAME=RECTYPE  ,ALIAS=M     ,USAGE=A1    ,ACTUAL=A1    ,$
FIELDNAME=PER_NAME ,ALIAS=PRN   ,USAGE=A50   ,ACTUAL=A50   ,$
SEGMENT=NEWSPAP, PARENT=DUMMY, SEGTYPE=S0,$
GROUP=NEWSKEY      ,ALIAS=KEY   ,USAGE=A11   ,ACTUAL=A11   ,$
FIELDNAME=NEWDAT   ,ALIAS=ND    ,USAGE=A6    ,ACTUAL=A6    ,$
FIELDNAME=NVOLNO   ,ALIAS=NV    ,USAGE=A2    ,ACTUAL=A2    ,$
FIELDNAME=NISSUE   ,ALIAS=NI    ,USAGE=A2    ,ACTUAL=A2    ,$
FIELDNAME=RECTYPE  ,ALIAS=N     ,USAGE=A1    ,ACTUAL=A1    ,$
FIELDNAME=NEWNAME  ,ALIAS=NN    ,USAGE=A50   ,ACTUAL=A50   ,$
  
```

Using a Generalized Record Type

If your fixed-format sequential, VSAM, or ISAM data source has multiple record types that share the same layout, you can specify a single generalized segment that describes all record types that have the common layout. By using a generalized segment (also known as a generalized RECTYPE) instead of one segment per record type, you reduce the number of segments you need to describe in the Master File.

When using a generalized segment, you identify RECTYPE values using the ACCEPT attribute. You can assign any value to the ALIAS attribute.

Specify a Generalized Record Type

```
FIELDNAME = RECTYPE, ALIAS = alias, USAGE = format, ACTUAL = format,
ACCEPT = {list|range} , $
```

where:

RECTYPE

Is the required field name.

i Note: Since the field name, RECTYPE, may not be unique across segments, you should not use it in this way unless you qualify it. An alias is not required. You may leave it blank.

alias

Is any valid alias specification. You can specify a unique name as the alias value for the RECTYPE field only if you use the ACCEPT attribute. The alias can then be used in a TABLE request as a display field, a sort field, or in selection tests using either WHERE or IF.

list

Is a list of one or more lines of specific RECTYPE values for records that have the same segment layout. The maximum number of characters allowed in the list is 255. Each item in the list must be separated by either a blank or the keyword OR. If the list contains embedded blanks or commas, it must be enclosed within single quotation

marks. The list may contain a single RECTYPE value. For example:

```
FIELDNAME = RECTYPE, ALIAS = TYPEABC, USAGE = A1, ACTUAL = A1,
ACCEPT = A OR B OR C, $
```

range

Is a range of one or more lines of RECTYPE values for records that have the same segment layout. The maximum number of characters allowed in the range is 255. If the range contains embedded blanks or commas, it must be enclosed within single quotation marks.

To specify a range of values, include the lowest value, the keyword TO, and the highest value, in that order. For example:

```
FIELDNAME = RECTYPE, ALIAS = ACCTREC, USAGE = P3, ACTUAL = P2,
ACCEPT = 100 TO 200, $
```

Using a Generalized Record Type

To illustrate the use of the generalized record type in a VSAM Master File, consider the following record layouts in the DOC data source. Record type DN is the root segment and contains the document number and title. Record types M, I, and C contain information about manuals, installation guides, and course guides, respectively. Notice that record types M and I have the same layout.

Record type DN:

```
---KEY---
+-----+
DOCID  FILLER          RECTYPE  TITLE
+-----+
```

Record type M:

```
-----KEY-----
+-----+
MDOCID  MDATE          RECTYPE  MRELEASE  MPAGES  FILLER
+-----+
```

Record type I:

```

-----KEY-----
+-----+
IDOCID  IDATE          RECTYPE  IRELEASE          IPAGES  FILLER
+-----+

```

Record type C:

```

-----KEY-----
+-----+
CRSEDOC  CDATE          RECTYPE  COURSENUM  LEVEL  CPAGES  FILLER
+-----+

```

Without the ACCEPT attribute, each of the four record types must be described as separate segments in the Master File. A unique set of field names must be provided for record type M and record type I, although they have the same layout.

The generalized RECTYPE capability enables you to code just one set of field names that applies to the record layout for both record type M and I. The ACCEPT attribute can be used for any RECTYPE specification, even when there is only one acceptable value.

```

FILENAME=DOC2, SUFFIX=VSAM,$
SEGNAME=ROOT, SEGTYPE=SO,$
GROUP=DOCNUM, ALIAS=KEY, A5, A5, $
FIELD=DOCID, ALIAS=SEQNUM, A5, A5, $
FIELD=FILLER, ALIAS=, A5, A5, $
FIELD=RECTYPE, ALIAS=DOCRECORD, A3, A3, ACCEPT = DN,$
FIELD=TITLE, ALIAS=, A18, A18, $
SEGNAME=MANUALS, PARENT=ROOT, SEGTYPE=SO,$
GROUP=MDOCNUM, ALIAS=KEY, A10, A10,$
FIELD=MDOCID, ALIAS=MSEQNUM, A5, A5, $
FIELD=MDATE, ALIAS=MPUBDATE, A5, A5, $
FIELD=RECTYPE, ALIAS=MANUAL, A3, A3, ACCEPT = M OR I,$
FIELD=MRELEASE, ALIAS=, A7, A7, $
FIELD=MPAGES, ALIAS=, I5, A5, $
FIELD=FILLER, ALIAS=, A6, A6, $
SEGNAME=COURSES, PARENT=ROOT, SEGTYPE=SO,$
GROUP=CRSEDOC, ALIAS=KEY, A10, A10,$
FIELD=CDOCID, ALIAS=CSEQNUM, A5, A5, $
FIELD=CDATE, ALIAS=CPUBDATE, A5, A5, $
FIELD=RECTYPE, ALIAS=COURSE, A3, A3, ACCEPT = C,$
FIELD=COURSENUM, ALIAS=CNUM, A4, A4, $
FIELD=LEVEL, ALIAS=, A2, A2, $

```

```
FIELD=CPAGES,    ALIAS=,          I5,  A5,  $
FIELD=FILLER,    ALIAS=,          A7,  A7,  $
```

Using an ALIAS in a Report Request

You can include an alias for the RECTYPE field if you use the ACCEPT attribute to specify one or more RECTYPE values in the Master File. This enables you to use the alias in a report request as a display field, as a sort field, or in selection tests using either WHERE or IF.

Using a RECTYPE Value in a Display Command

Display the RECTYPE values by including the alias as a display field. In this example, the alias MANUAL displays the RECTYPE values M and I:

```
TABLE FILE DOC
PRINT MANUAL MRELEASE MPAGES
BY DOCID BY TITLE BY MDATE
END
```

The output is:

```
PAGE 1

DOCID      TITLE                                MDATE  RECTYPE  MRELEASE  MPAGES
-----
40001     FOCUS USERS MANUAL                 8601    M        5.0       1800
          8708    M        5.5       2000
40057     MVS INSTALL GUIDE                 8806    I        5.5.3     66
          8808    I        5.5.4     66
40114     zOS INSTALL GUIDE                 8806    I        5.5.3     58
          8808    I        5.5.4     58
```

Using a RECTYPE Value in a WHERE Test

You can use the alias in a WHERE test to display a subset of records:

```
TABLE FILE DOC
PRINT MANUAL MRELEASE MPAGES
BY DOCID BY TITLE BY MDATE
WHERE MANUAL EQ 'I'
END
```

The output is:

```
PAGE 1

DOCID      TITLE                MDATE  RECTYPE  MRELEASE  MPAGES
-----      -
40057      MVS INSTALL  GUIDE  8806    I         5.5.3     66
           8808    I         5.5.4     66
40114      zOS INSTALL  GUIDE  8806    I         5.5.3     58
           8808    I         5.5.4     58
```

Combining Multiply Occurring Fields and Multiple Record Types

You can have two types of descendant segments in a single fixed-format sequential, VSAM, or ISAM data source:

- Descendant segments consisting of multiply occurring fields.
- Additional descendant segments consisting of multiple record types.

Describing a Multiply Occurring Field and Multiple Record Types

In the data structure shown below, the first record (of type 01) contains several different sequences of repeating fields, all of which must be described as descendant segments with an OCCURS attribute. The data source also contains two separate records, of types 02 and 03, which contain information that is related to that in record type 01.

The relationship between the records of various types is expressed as parent-child relationships. The children that contain record types 02 and 03 do not have an OCCURS

attribute. They are distinguished from their parent by the field declaration where field=RECTYPE.

0	T	N	B	B	C	C	D	D	D	D	D	D	D	B	B	C	C	D	D	D	D	D	D
1	1	1	1	2	1	1	1	1	1	1	1	1	1	1	2	1	1	1	1	1	1	1	1

02	E1
----	----

03	F1
----	----

The description for this data source is:

```

FILENAME = EXAMPLE1, SUFFIX = FIX,$
SEGNAME = A, SEGTYPE=S0,$
  FIELDNAME = RECTYPE ,ALIAS = 01 ,USAGE = A2 ,ACTUAL = A2 ,$
  FIELDNAME = T1 ,ALIAS = ,USAGE = A2 ,ACTUAL = A1 ,$
  FIELDNAME = N1 ,ALIAS = ,USAGE = A1 ,ACTUAL = A1 ,$
SEGNAME = B, PARENT = A, OCCURS = VARIABLE, SEGTYPE=S0,$
  FIELDNAME = B1 ,ALIAS = ,USAGE = I2 ,ACTUAL = I2 ,$
  FIELDNAME = B2 ,ALIAS = ,USAGE = I2 ,ACTUAL = I2 ,$
SEGNAME = C, PARENT = B, OCCURS = B1, SEGTYPE=S0,$
  FIELDNAME = C1 ,ALIAS = ,USAGE = A1 ,ACTUAL = A1 ,$
SEGNAME = D, PARENT = B, OCCURS = 7, SEGTYPE=S0,$
  FIELDNAME = D1 ,ALIAS = ,USAGE = A1 ,ACTUAL = A1 ,$
SEGNAME = E, PARENT = A, SEGTYPE=S0,$
  FIELDNAME = RECTYPE ,ALIAS = 02 ,USAGE = A2 ,ACTUAL = A2 ,$
  FIELDNAME = E1 ,ALIAS = ,USAGE = A1 ,ACTUAL = A1 ,$
SEGNAME = F, PARENT = E, SEGTYPE=S0,$
  FIELDNAME = RECTYPE ,ALIAS = 03 ,USAGE = A2 ,ACTUAL = A2 ,$
  FIELDNAME = F1 ,ALIAS = ,USAGE = A1 ,ACTUAL = A1 ,$

```

It produces the following data structure:

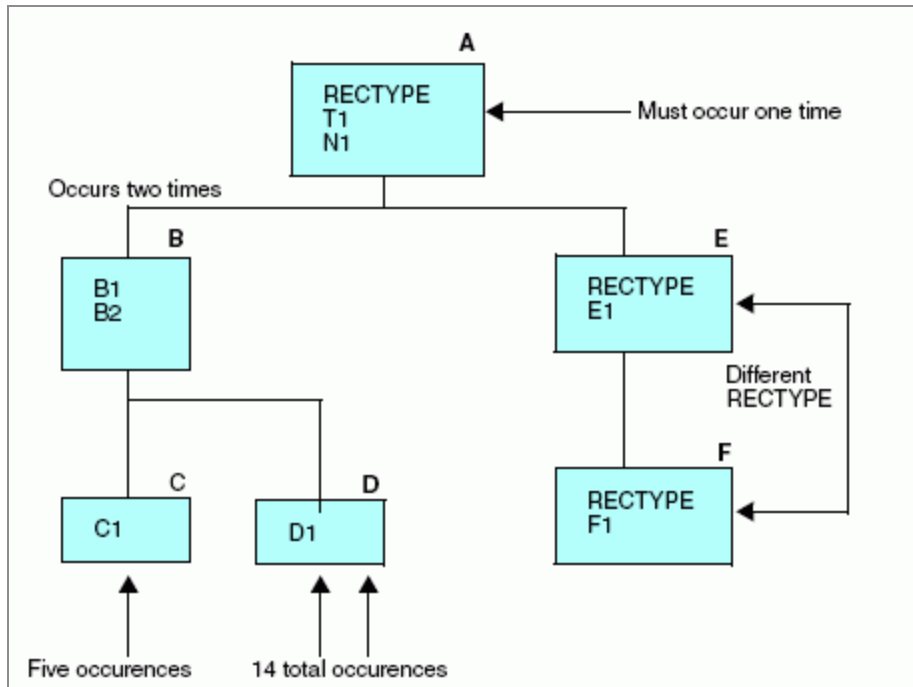

Segments A, B, C, and D all belong to the same record type. Segments E and F each are stored as separate record types.

i Note:

- Segments A, E, and F are different records that are related through their record types. The record type attribute consists of certain prescribed values, and is stored in a fixed location in the records. Records are expected to be retrieved in a given order. If the first record does not have a RECTYPE of 01, the record is considered to be a child without a parent. The next record can have a RECTYPE of either 01 (in which case, the first record is considered to have no descendants except the OCCURS descendants) or 02. A record with a RECTYPE of 03 can follow only a record with a RECTYPE of 02 (its parent) or another 03.
- The OCCURS descendants all belong to the record whose RECTYPE is 01. (This is not a necessary condition. Records of any type can have OCCURS descendants.) Note that the OCCURS=VARIABLE segment, Segment B, is the right-most segment within its own record type. If you look at the data structure, the pattern that makes up Segment B and its descendants (the repetition of fields B1, B2, C1, and D1) extends from the first mention of fields B1 and B2 to the end of the record.
- Although fields C1 and D1 appear in separate segments, they are actually part of the repeating pattern that makes up the OCCURS=VARIABLE segment. Since they occur multiple times within Segment B, they are each assigned to their own descendant segment. The number of times field C1 occurs depends on the value of field B2. In the example, the first value of field B2 is 3. The second, 2. Field D1 occurs a fixed number of times, 7.

Describing a VSAM Repeating Group With RECTYPES

Suppose you want to describe a data source that, schematically, looks like this:

A	RECTYPE	B C	RECTYPE	B C
A	RECTYPE	D	RECTYPE	D

You must describe three segments in your Master File, with A as the root segment, and segments for B, C, and D as two descendant OCCURS segments for A.

The following diagram illustrates these segments.

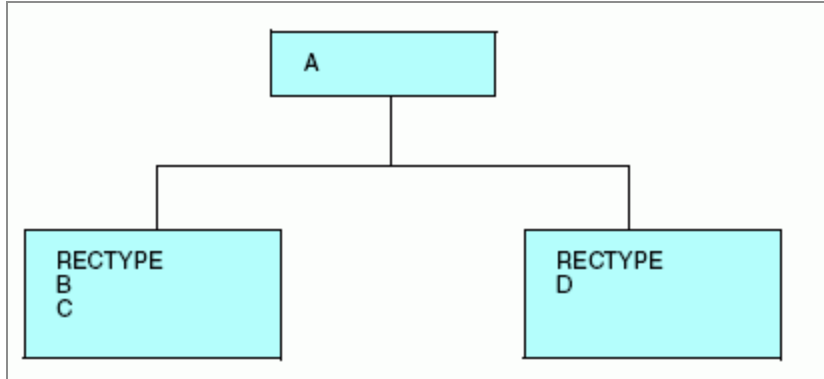

Each of the two descendant OCCURS segments in this example depends on the RECTYPE indicator that appears for each occurrence.

All the rules of syntax for using RECTYPE fields and OCCURS segments also apply to RECTYPEs within OCCURS segments.

Since each OCCURS segment depends on the RECTYPE indicator for its evaluation, the RECTYPE must appear at the start of the OCCURS segment. This enables you to describe complex data sources, including those with nested and parallel repeating groups that depend on RECTYPEs.

Describing a VSAM Repeating Group With RECTYPEs

In this example, B/C, and D represent a nested repeating group, and E represents a parallel repeating group.

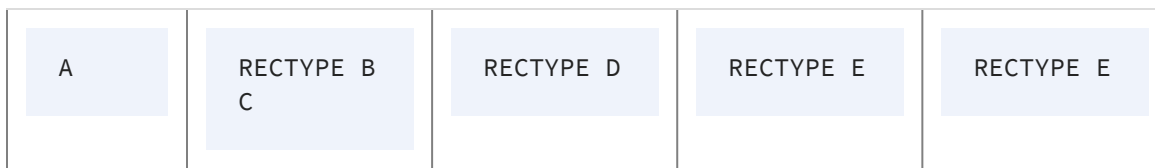

```
FILENAME=SAMPLE,SUFFIX=VSAM,$
SEGNAME=ROOT,SEGTYPE=S0,$
GROUP=GRPKEY,ALIAS=KEY,USAGE=A8,ACTUAL=A8,$
FIELD=FLD000,E00,A08,A08,$
```

```

FIELD=A_DATA      ,E01      ,A02      ,A02      ,,$
SEGNAME=SEG001,PARENT=ROOT,OCURS=VARIABLE,SEGTYPE=S0 ,,$
FIELD=RECTYPE     ,A01      ,A01      ,ACCEPT=B OR C ,,$
FIELD=B_OR_C_DATA ,E02      ,A08      ,A08      ,,$
SEGNAME=SEG002,PARENT=SEG001,OCURS=VARIABLE,SEGTYPE=S0 ,,$
FIELD=RECTYPE     ,D        ,A01      ,A01      ,,$
FIELD=D_DATA      ,E03      ,A07      ,A07      ,,$
SEGNAME=SEG003,PARENT=ROOT,OCURS=VARIABLE,SEGTYPE=S0 ,,$
FIELD=RECTYPE     ,E        ,A01      ,A01      ,,$
FIELD=E_DATA      ,E04      ,A06      ,A06      ,,$

```

Describing a Repeating Group Using MAPFIELD

In another combination of record indicator and OCCURS, a record contains a record indicator that is followed by a repeating group. In this case, the record indicator is in the fixed portion of the record, not in each occurrence. Schematically, the record appears like this:

A B	record indicator (1)	C D	C D	C D
A B	record indicator (2)	E E		

The first record contains header information, values for A and B, followed by an OCCURS segment of C and D that was identified by its preceding record indicator. The second record has a different record indicator and contains a different repeating group, this time for E.

The following diagram illustrates this relationship:

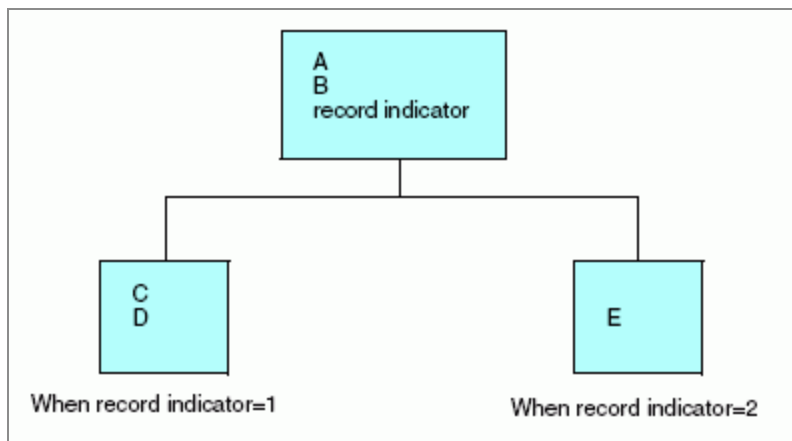

Since the OCCURS segments are identified by the record indicator rather than the parent A/B segment, you must use the keyword MAPFIELD. MAPFIELD identifies a field in the same way as RECTYPE, but since each OCCURS segment has its own value for MAPFIELD, the value of MAPFIELD is associated with each OCCURS segment by means of a complementary field named MAPVALUE.

The following diagram illustrates this relationship:

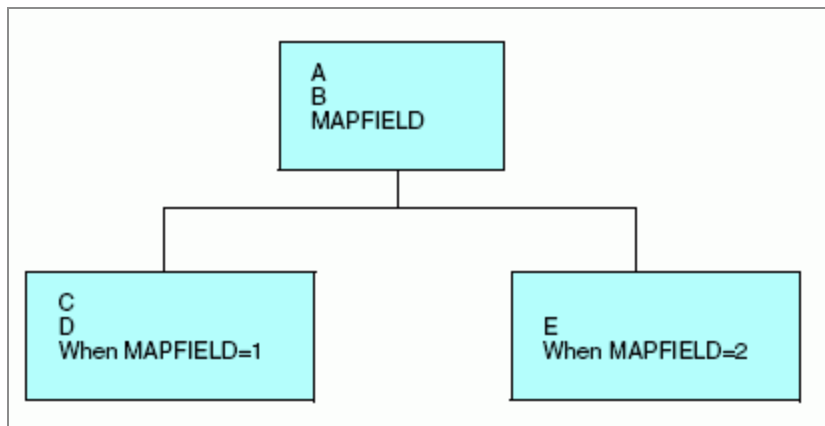

MAPFIELD is assigned as the ALIAS of the field that is the record indicator. It may have any name.

Describe a Repeating Group With MAPFIELD

```
FIELD = name, ALIAS = MAPFIELD, USAGE = format, ACTUAL = format,$
```

where:

name

Is the name you choose to provide for this field.

ALIAS

MAPFIELD is assigned as the alias of the field that is the RECTYPE indicator.

USAGE

Follows the usual field format.

ACTUAL

Follows the usual field format.

The descendant segment values depend on the value of the MAPFIELD. They are described as separate segments, one for each possible value of MAPFIELD, and all descending from the segment that has the MAPFIELD. A special field, MAPVALUE, is described as the last field in these descendant segments after the ORDER field, if one has been used. The actual MAPFIELD value is supplied as the ALIAS of MAPVALUE.

Use MAPFIELD for a Descendant Repeating Segment in a Repeating Group

```
FIELD = MAPVALUE, ALIAS = alias, USAGE = format, ACTUAL = format,
ACCEPT = {list|range} , $
```

where:

MAPVALUE

Indicates that the segment depends on a MAPFIELD in its parent segment.

alias

Is the primary MAPFIELD value, if an ACCEPT list is not specified. If there is an ACCEPT list, this can be any value.

USAGE

Is the same format as the MAPFIELD format in the parent segment.

ACTUAL

Is the same format as the MAPFIELD format in the parent segment.

list

Is the list of one or more lines of specified MAPFIELD values for records that have the same segment layout. The maximum number of characters allowed in the list is 255. Each item in the list must be separated by either a blank or the keyword OR. If the list contains embedded blanks or commas, it must be enclosed within single quotation

marks ('). The list may contain a single MAPFIELD value.

For example:

```
FIELDNAME = MAPVALUE, ALIAS = A, USAGE = A1, ACTUAL = A1,
ACCEPT = A OR B OR C,$
```

range

Is a range of one or more lines of MAPFIELD values for records that have the same segment layout. The maximum number of characters allowed in the range is 255. If the range contains embedded blanks or commas, it must be enclosed in single quotation marks (').

To specify a range of values, include the lowest value, the keyword TO, and the highest value, in that order.

Using MAPFIELD and MAPVALUE

Using the sample data source at the beginning of this section, the Master File for this data source looks like this:

```
FILENAME=EXAMPLE,SUFFIX=FIX,$
SEGNAME=ROOT,SEGTYPE=S0,$
  FIELD =A,           ,A14   ,A14  ,$
  FIELD =B,           ,A10   ,A10  ,$
  FIELD =FLAG ,MAPFIELD ,A01   ,A01  ,$
SEGNAME=SEG001,PARENT=ROOT,OCCURS=VARIABLE,SEGTYPE=S0  ,$
  FIELD =C,           ,A05   ,A05  ,$
  FIELD =D,           ,A07   ,A07  ,$
  FIELD =MAPVALUE ,1   ,A01   ,A01  ,$
SEGNAME=SEG002,PARENT=ROOT,OCCURS=VARIABLE,SEGTYPE=S0  ,$
  FIELD =E,           ,D12.2 ,D8   ,$
  FIELD =MAPVALUE ,2   ,A01   ,A01  ,$
```

i Note: MAPFIELD can only exist on an OCCURS segment that has not been re-mapped. This means that the segment definition cannot contain `POSITION=fieldname`.

MAPFIELD and MAPVALUE may be used with SUFFIX=FIX and SUFFIX=VSAM data sources.

Establishing VSAM Data and Index Buffers

Two SET commands make it possible to establish DATA and INDEX buffers for processing VSAM data sources online.

The AMP subparameters BUFND and BUFNI enable z/OS batch users to enhance the I/O efficiency of TABLE, TABLEF, MODIFY, and JOIN against VSAM data sources by holding frequently used VSAM Control Intervals in memory, rather than on physical DASD. By reducing the number of physical Input/Output operations, you may improve job throughput. The SET commands enable users (in z/OS and MSO) to realize similar performance gains in interactive sessions. In general, BUFND (data buffers) increases the efficiency of physical sequential reads, whereas BUFNI (index buffers) are most beneficial in JOIN or KEYED access operations.

Establish VSAM Data and Index Buffers

```
MVS VSAM SET BUFND {n|8}
MVS VSAM SET BUFNI {n|1}
```

where:

n

Is the number of data or index buffers. BUFND=8 and BUFNI=1 (eight data buffers and one index buffer) are the default values.

i Note: The AMODE setting controls whether the buffers are created above or below the line. SET AMODE=31 places the buffers above the line. SET AMODE=24 places the buffers below the line.

Determining How Many Buffers Are in Effect

```
MVS VSAM SET ?
```

Using a VSAM Alternate Index

VSAM key-sequenced data sources support the use of alternate key indexes (keys). A key-sequenced VSAM data source consists of two components: an index component and a data component. The data component contains the actual data records, while the index component is the key used to locate the data records in the data source. Together, these components are referred to as the base cluster.

An alternate index is a separate, additional index structure that enables you to access records in a KSDS VSAM data source based on a key other than the data source primary key. For instance, you may usually use a personnel data source sequenced by Social Security number, but occasionally need to retrieve records sorted by job description. The job description field might be described as an alternate index. An alternate index must be related to the base cluster it describes by a path, which is stored in a separate data source.

The alternate index is a VSAM structure and is, consequently, created and maintained in the VSAM environment. It can, however, be described in your Master File, so that you can take advantage of the benefits of an alternate index.

The primary benefit of these indexes is improved efficiency. You can use it as an alternate, more efficient, retrieval sequence or take advantage of its potential indirectly, with screening tests (IF...LT, IF...LE, IF...GT, IF...GE, IF...EQ, IF...FROM...TO, IF...IS), which are translated into direct reads against the alternate index. You can also join data sources with the JOIN command through this alternate index.

It is not necessary to identify the indexed view explicitly in order to take advantage of the alternate index. An alternate index is automatically used when described in the Master File.

To take advantage of a specific alternate index during a TABLE request, provide a WHERE or IF test on the alternative index field that meets the above criteria. For example:

```
TABLE FILE CUST
PRINT SSN
WHERE LNAME EQ 'SMITH'
END
```

As you see in the Master File in [Describing a VSAM Alternate Index](#), the LNAME field is defined as an alternate index field. The records in the data source are retrieved according to their last names, and certain IF screens on the field LNAME result in direct reads. Note that if the alternate index field name is omitted, the primary key (if there is any) is used for a sequential or a direct read, and the alternate indexes are treated as regular fields.

Alternate indexes must be described in the Master File as fields with FIELDTYPE=I. The ALIAS of the alternate index field must be the file name allocated to the corresponding path name. Alternate indexes can be described as GROUPs if they consist of portions with dissimilar formats. Remember that ALIAS=KEY must be used to describe the primary key.

Only one record type can be referred to in the request when using alternate indexes, but there is no restriction on the number of OCCURS segments.

Note that the path name in the allocation is different from both the cluster name and the alternate index name.

If you are not sure of the path names and alternate indexes associated with a given base cluster, you can use the IDCAMS utility. (See the IBM manual entitled *Using VSAM Commands and Macros* for details.)

Describing a VSAM Alternate Index

Consider the following:

```
FILENAME = CUST, SUFFIX = VSAM,$
SEGNAME = ROOT, SEGTYPE = S0,$
GROUP = G, ALIAS = KEY, A10, A10,$
FIELD = SSN, SSN, A10, A10,$
FIELD = FNAME, DD1, A10, A10, FIELDTYPE=I,$
FIELD = LNAME, DD2, A10, A10, FIELDTYPE=I,$
```

In this example, SSN is a primary key and FNAME and LNAME are alternate indexes. The path data set must be allocated to the ddname specified in ALIAS= of your alternate index field. In this Master File, ALIAS=DD1 and ALIAS=DD2 each have an allocation pointing to the path data set. FNAME and LNAME must have INDEX=I or FIELDTYPE=I coded in the Master File. CUST must be allocated to the base cluster.

Using IDCAMS

The following example demonstrates how to use IDCAMS to find the alternate index and path names associated with a base cluster named CUST.DATA:

First, find the alternate index names (AIX) associated with the given cluster.

```
IDCAMS input:
LISTCAT CLUSTER ENTRIES(CUST.DATA) ALL
```

```
IDCAMS output (fragments):
CLUSTER ----- CUST.DATA
ASSOCIATIONS
AIX ----- CUST.INDEX1
AIX ----- CUST.INDEX2
```

This gives you the names of the alternate indexes (AIX): CUST.INDEX1 and CUST.INDEX2.

Next, find the path names associated with the given AIX name:

```
IDCAMS input:
LISTCAT AIX ENTRIES (CUST.INDEX1 CUST.INDEX2) ALL
```

```
IDCAMS output (fragments):
AIX -----CUST.INDEX1
ASSOCIATIONS
CLUSTER -- CUST.DATA
PATH -----CUST.PATH1
AIX -----CUST.INDEX2
ASSOCIATIONS
CLUSTER -- CUST.DATA
PATH -----CUST.PATH2
```

This gives you the path names: CUST.PATH1 and CUST.PATH2.

This information, along with the TSO DDNAME command, may be used to ensure the proper allocation of your alternate index.

Describing a Token-Delimited Data Source

You can read files in which fields are separated by any type of delimiter including commas, tabs and other characters. Defining a Master File with the SUFFIX=DFIX attribute lets you specify any combination of characters as the field delimiter. Delimiters may consist of printable or non-printable characters, or any combination of printable and non-printable characters.

Two methods of describing delimited files are supported:

- Placing delimiter information in the Master File.

- Placing delimiter information in the Access File. This method also allows you to specify an enclosure character for alphanumeric fields, preserve leading and trailing blank spaces in alphanumeric data, and specify whether you want a header record in the file to contain column titles for the fields in the file. In addition, you can create this type of delimited file using the HOLD FORMAT DFIX command. For information on HOLD formats, see the *FOCUS® Creating Reports* manual.

Note: SET HOLDLIST is not supported for delimited files.

Defining a Delimiter in the Master File

Delimiters in the Master File are defined using a special field named DELIMITER. The FILE declaration must include the attribute SUFFIX=DFIX.

Define a File With Delimiters in the Master File

Describe the delimiter characters in a special field or group named DELIMITER. The delimiter characters are specified in the ALIAS attribute of this special field or group.

To use a delimiter that consists of a single non-printable character or of one or more printable characters, the delimiter is defined as a field with the following attributes:

```
FIELDNAME=DELIMITER, ALIAS=delimiter, USAGE=ufmt, ACTUAL=afmt , $
```

To use a delimiter that consists of multiple non-printable characters or a combination of printable and non-printable characters, the delimiter is defined as a group:

```
GROUP=DELIMITER, ALIAS= , USAGE=ufmtg, ACTUAL=afmtg , $
FIELDNAME=DELIMITER, ALIAS=delimiter1, USAGE=ufmt1, ACTUAL=afmt1 , $
.
.
.
FIELDNAME=DELIMITER, ALIAS=delimitern, USAGE=ufmtn, ACTUAL=afmtn , $
```

where:

DELIMITER

Indicates that the field or group is used as the delimiter in the data source.

delimiter

Identifies a delimiter, up to 30 characters long. For one or more printable characters, the value consists of the actual characters. The delimiter must be enclosed in single quotation marks if it includes characters used as delimiters in Master File syntax. For a non-printable character, the value is the decimal equivalent of the EBCDIC or ASCII representation of the character, depending on your operating environment.

ufmt, afmt

Are the USAGE and ACTUAL formats for the delimiter. Possible values are:

Type of delimiter	USAGE	ACTUAL
Printable characters	An where n is the number of characters	An where n is the number of characters
Non-printable character such as Tab	I4	I1
Group (combination of printable and non-printable characters, or multiple non-printable characters)	Sum of the individual USAGE lengths	Sum of the individual ACTUAL lengths

Usage Notes for a Token-Delimited File

- If the delimiter is alphanumeric and the delimiter value contains special characters (those used as delimiters in Master File syntax), it must be enclosed in single quotation marks.
- If the data is numeric and has a zoned format (ACTUAL=Zn), the data must be unsigned (cannot contain a positive or negative value).
- Numeric values may be used to represent any character, but are predominantly used

for non-printable characters such as Tab. The numeric values may differ between EBCDIC and ASCII platforms.

- A delimiter is needed to separate field values. A pair of delimiters denotes a missing or default field value.
- Trailing delimiters are not necessary except that all fields must be terminated with the delimiter if the file has fixed length records.
- Only one delimiter field or group is permitted per Master File.
- Token-delimited files support the RECTYPE, POSITION, and OCCURS attributes. For information about RECTYPE, see [Describing Multiple Record Types](#). For information about OCCURS, see [Describing a Multiply Occurring Field in a Fixed-Format, VSAM, or ISAM Data Source](#).

Defining a Delimiter in the Master File

The following example shows a one-character alphanumeric delimiter:

```
FIELDNAME=DELIMITER, ALIAS=', ' ,USAGE=A1, ACTUAL=A1 ,,$
```

The following example shows a two-character alphanumeric delimiter:

```
FIELDNAME=DELIMITER, ALIAS='/' ,USAGE=A2, ACTUAL=A2 ,,$
```

The following example shows how to use the Tab character as a delimiter:

```
FIELDNAME=DELIMITER, ALIAS=05 ,USAGE=I4, ACTUAL=I1 ,,$
```

The following example shows how to use a blank character described as a numeric delimiter:

```
FIELDNAME=DELIMITER, ALIAS=64 ,USAGE=I4, ACTUAL=I1 ,,$
```

The following example shows a group delimiter (Tab-slash-Tab combination):

```
GROUP=DELIMITER, ALIAS= ,USAGE=A9, ACTUAL=A3 ,,$
FIELDNAME=DEL1, ALIAS=05 ,USAGE=I4, ACTUAL=I1 ,,$
```

```
FIELDNAME=DEL2, ALIAS=/ ,USAGE=A1, ACTUAL=A1 , $
FIELDNAME=DEL3, ALIAS=05 ,USAGE=I4, ACTUAL=I1 , $
```

Separating Field Values for Missing Data

The following Master File shows the MISSING attribute specified for the CAR field:

```
FILE=DFIXF01 ,SUFFIX=DFIX
SEGNAME=SEG1 ,SEGTYPE=S0
FIELDNAME=COUNTRY ,ALIAS=F1 ,USAGE=A10 ,ACTUAL=A10 , $
FIELDNAME=CAR ,ALIAS=F2 ,USAGE=A16 ,ACTUAL=A16 ,MISSING=ON, $
FIELDNAME=NUMBER ,ALIAS=F3 ,USAGE=P10 ,ACTUAL=Z10 , $
FIELDNAME=DELIMITER ,ALIAS=' , ' ,USAGE=A1 ,ACTUAL=A1 , $
```

In the source file, two consecutive comma delimiters indicate missing values for CAR:

```
GERMANY ,VOLKSWAGEN ,1111
GERMANY ,BMW ,
USA ,CADILLAC ,22222
USA ,FORD
USA , ,44444
JAPAN
ENGLAND ,
FRANCE
```

The output is:

COUNTRY	CAR	NUMBER
-----	---	-----
GERMANY	VOLKSWAGEN	1111
GERMANY	BMW	0
USA	CADILLAC	22222
USA	FORD	0
USA	.	44444
JAPAN	.	0
ENGLAND	.	0
FRANCE	.	0

Defining a Delimiter in the Access File

The Master File has the standard attributes for any sequential file. The SUFFIX value is DFIX. All of the delimiter information is in the Access File.

In addition, you can use the HOLD FORMAT DFIX command to create this type of Master and Access File for a token-delimited file. For information on HOLD formats, see the *FOCUS® Creating Reports* manual.

Access File Attributes for a Delimited Sequential File

```
DELIMITER = delimiter [,ENCLOSURE = enclosure]
            [,HEADER = {YES|NO}] [,SKIP_ROWS = n] [,PRESERVESPACE={YES|NO}]
            [,RDELIMITER=rdelimiter], $
```

where:

delimiter

Is the delimiter sequence consisting of up to 30 printable or non-printable non-null characters. This represents character semantics. For example, if you are using DBCS characters, the delimiter can be up to 60 bytes. For a non-printable character, enter the hexadecimal value that represents the character. If you use a mixture of printable and non-printable characters, you must enter them all as hexadecimal values. For printable characters you can either use the characters themselves or their hexadecimal equivalents (for example, the ampersand character may be interpreted as the beginning of a variable name rather than as part of the delimiter). To create a tab-delimited file, you can specify the delimiter value as **TAB** or as its hexadecimal equivalent (0x09 on ASCII platforms or 0x05 on EBCDIC platforms). To create a file delimited by a single quotation mark, you must specify the single quotation mark delimiter value as its hexadecimal equivalent (0x27 on ASCII platforms or 0x7D on EBCDIC platforms), otherwise the request will not be parsed correctly and will result in an unusable HOLD file.

Note that numeric digits and symbols used in numbers, such as a period (.), plus sign (+), or minus sign (-) cannot be used in the delimiter sequence.

enclosure

Is the enclosure sequence. It can be up to four printable or non-printable characters used to enclose each alphanumeric value in the file. This represents character semantics. For example, if you are using DBCS characters, the enclosure can be up to 8 bytes. Most alphanumeric characters can be used as all or part of the enclosure sequence. However, numeric digits and symbols used in numbers, such as a period (.), plus sign (+), or minus sign (-) cannot be used in the enclosure sequence. Also note that, in order to specify a single quotation mark as the enclosure character, you must enter four consecutive single quotation marks. The most common enclosure is one double quotation mark.

If you use a mixture of printable and non-printable characters, you must enter them all as hexadecimal values. For printable characters, you can either use the characters themselves or their hexadecimal equivalents (for example, the ampersand character may be interpreted as the beginning of a variable name rather than as part of the enclosure).

HEADER = {YES|NO}

Specifies whether to include a header record that contains the names of the fields in the delimited sequential file generated by the request. NO is the default value.

SKIP_ROWS = n

Specifies the number of rows above the header row that should be ignored when creating the synonym and reading the data.

PRESERVE SPACE={YES|NO}

Specifies whether to retain leading and trailing blanks in alphanumeric data. YES preserves leading and trailing blanks. NO only preserves leading and trailing blanks that are included within the enclosure characters. NO is the default value.



Note: PRESERVE SPACE is overridden by the ENCLOSURE option. Therefore, exclude the enclosure option in order to have the PRESERVE SPACE setting respected.

rdelimiter

Is the record delimiter sequence consisting of up to 30 printable or non-printable non-null characters. (This represents character semantics. For example, if you are using DBCS characters, the delimiter can be up to 60 bytes.) For a non-printable character,

enter the hexadecimal value that represents the character. If you use a mixture of printable and non-printable characters, you must enter them all as hexadecimal values. For printable characters you can either use the characters themselves or their hexadecimal equivalents (for example, the ampersand character may be interpreted as the beginning of a variable name rather than as part of the delimiter.) To use a tab character as the record delimiter, you can specify the delimiter value as **TAB** or as its hexadecimal equivalent (0x09 on ASCII platforms or 0x05 on EBCDIC platforms). The comma (,) is not supported as a record delimiter.

Note that numeric digits and symbols used in numbers, such as a period (.), plus sign (+), or minus sign (-) cannot be used in the delimiter sequence. When RDELIMITER is included, the RECFM is UB.

Master and Access File for a Pipe Delimited File

The pipe delimited file named PIPE1 contains the following data in which each data value is delimited by a pipe character (|). Note that you can create a delimited file as output from a request using the HOLD FORMAT DFIX command in a request:

```
EAST|2000|3907|1145655.77
EAST|2001|495922|127004359.88
EAST|2002|543678|137470917.05
NORTH|2001|337168|85750735.54
NORTH|2002|370031|92609802.80
SOUTH|2000|3141|852550.45
SOUTH|2001|393155|99822662.88
SOUTH|2002|431575|107858412.0
WEST|2001|155252|39167974.18
WEST|2002|170421|42339953.45
```

The PIPE1 Master File is:

```
FILENAME=PIPE1 , SUFFIX=DFIX , $
  SEGMENT=PIPE1, SEGTYPE=S2, $
    FIELDNAME=REGION, ALIAS=E01, USAGE=A5, ACTUAL=A05, $
    FIELDNAME=YEAR, ALIAS=E02, USAGE=YY, ACTUAL=A04, $
    FIELDNAME=QUANTITY, ALIAS=E03, USAGE=I8C, ACTUAL=A08, $
    FIELDNAME=LINEPRICE, ALIAS=E04, USAGE=D12.2MC, ACTUAL=A12, $
```

The PIPE1 Access File is:

```
SEGNAME=PIPE1, DELIMITER=|, HEADER=NO, $
```

In the following version of the PIPE1 delimited file, each alphanumeric value is enclosed in double quotation marks:

```
"EAST" | 2000 | 3907 | 1145655.77
"EAST" | 2001 | 495922 | 127004359.88
"EAST" | 2002 | 543678 | 137470917.05
"NORTH" | 2001 | 337168 | 85750735.54
"NORTH" | 2002 | 370031 | 92609802.80
"SOUTH" | 2000 | 3141 | 852550.45
"SOUTH" | 2001 | 393155 | 99822662.88
"SOUTH" | 2002 | 431575 | 107858412.01
"WEST" | 2001 | 155252 | 39167974.18
"WEST" | 2002 | 170421 | 42339953.45
```

The Master File does not change, but the Access File now specifies the enclosure character:

```
SEGNAME=PIPE1, DELIMITER=|, ENCLOSURE=", $
```

In this version of the PIPE1 delimited file, the first record in the file specifies the name of each field, and each alphanumeric value is enclosed in double quotation marks:

```
"REGION" | "YEAR" | "QUANTITY" | "LINEPRICE"
"EAST" | 2000 | 3907 | 1145655.77
"EAST" | 2001 | 495922 | 127004359.88
"EAST" | 2002 | 543678 | 137470917.05
"NORTH" | 2001 | 337168 | 85750735.54
"NORTH" | 2002 | 370031 | 92609802.80
"SOUTH" | 2000 | 3141 | 852550.45
"SOUTH" | 2001 | 393155 | 99822662.88
"SOUTH" | 2002 | 431575 | 107858412.01
"WEST" | 2001 | 155252 | 39167974.18
"WEST" | 2002 | 170421 | 42339953.45
```

The Master File remains the same. The Access File now specifies that there is a header record in the data file:

```
SEGNAME=PIPE1, DELIMITER=|, ENCLOSURE=", HEADER=YES, $
```

Creating a Delimited File With Blank Spaces Preserved

The following request against the GGSALES data source creates a comma-delimited file. The original alphanumeric data has trailing blank spaces. The PRESERVE SPACE YES option in the HOLD command preserves these trailing blank spaces:

```
APP HOLDDATA APP1
APP HOLDMETA APP1
TABLE FILE GGSALES
SUM DOLLARS UNITS
BY REGION
BY CATEGORY
BY PRODUCT
ON TABLE HOLD AS DFIX1 FORMAT DFIX DELIMITER , PRESERVE SPACE YES
END
```

The following Master File is generated:

```
FILENAME=DFIX1 , SUFFIX=DFIX , $
SEGMENT=DFIX1, SEGTYPE=S3, $
FIELDNAME=REGION, ALIAS=E01, USAGE=A11, ACTUAL=A11, $
FIELDNAME=CATEGORY, ALIAS=E02, USAGE=A11, ACTUAL=A11, $
FIELDNAME=PRODUCT, ALIAS=E03, USAGE=A16, ACTUAL=A16, $
FIELDNAME=DOLLARS, ALIAS=E04, USAGE=I08, ACTUAL=A08, $
FIELDNAME=UNITS, ALIAS=E05, USAGE=I08, ACTUAL=A08, $
```

The following Access File is generated:

```
SEGNAME=DFIX1, DELIMITER=',', HEADER=NO, PRESERVE SPACE=YES, $
```

In the DFIX1 file, the alphanumeric fields contain all of the blank spaces that existed in the original file:

```
Midwest ,Coffee ,Espresso ,1294947,101154
Midwest ,Coffee ,Latte ,2883566,231623
Midwest ,Food ,Biscotti ,1091727,86105
Midwest ,Food ,Croissant ,1751124,139182
Midwest ,Food ,Scone ,1495420,116127
```

```

Midwest ,Gifts ,Coffee Grinder ,619154,50393
Midwest ,Gifts ,Coffee Pot ,599878,47156
Midwest ,Gifts ,Mug ,1086943,86718
Midwest ,Gifts ,Thermos ,577906,46587
Northeast ,Coffee ,Capuccino ,542095,44785
Northeast ,Coffee ,Espresso ,850107,68127
Northeast ,Coffee ,Latte ,2771815,222866
Northeast ,Food ,Biscotti ,1802005,145242
Northeast ,Food ,Croissant ,1670818,137394
Northeast ,Food ,Scone ,907171,70732
Northeast ,Gifts ,Coffee Grinder ,509200,40977
Northeast ,Gifts ,Coffee Pot ,590780,46185
Northeast ,Gifts ,Mug ,1144211,91497
Northeast ,Gifts ,Thermos ,604098,48870
Southeast ,Coffee ,Capuccino ,944000,73264
Southeast ,Coffee ,Espresso ,853572,68030
Southeast ,Coffee ,Latte ,2617836,209654
Southeast ,Food ,Biscotti ,1505717,119594
Southeast ,Food ,Croissant ,1902359,156456
Southeast ,Food ,Scone ,900655,73779
Southeast ,Gifts ,Coffee Grinder ,605777,47083
Southeast ,Gifts ,Coffee Pot ,645303,49922
Southeast ,Gifts ,Mug ,1102703,88474
Southeast ,Gifts ,Thermos ,632457,48976
West ,Coffee ,Capuccino ,895495,71168
West ,Coffee ,Espresso ,907617,71675
West ,Coffee ,Latte ,2670405,213920
West ,Food ,Biscotti ,863868,70436
West ,Food ,Croissant ,2425601,197022
West ,Food ,Scone ,912868,72776
West ,Gifts ,Coffee Grinder ,603436,48081
West ,Gifts ,Coffee Pot ,613624,47432
West ,Gifts ,Mug ,1188664,93881
West ,Gifts ,Thermos ,571368,45648

```

Creating the same file with PRESERVE SPACE NO removes the trailing blank spaces:

```

Midwest,Coffee,Espresso,1294947,101154
Midwest,Coffee,Latte,2883566,231623
Midwest,Food,Biscotti,1091727,86105
Midwest,Food,Croissant,1751124,139182
Midwest,Food,Scone,1495420,116127
Midwest,Gifts,Coffee Grinder,619154,50393
Midwest,Gifts,Coffee Pot,599878,47156
Midwest,Gifts,Mug,1086943,86718
Midwest,Gifts,Thermos,577906,46587

```

```
Northeast,Coffee,Capuccino,542095,44785
Northeast,Coffee,Espresso,850107,68127
Northeast,Coffee,Latte,2771815,222866
Northeast,Food,Biscotti,1802005,145242
Northeast,Food,Croissant,1670818,137394
Northeast,Food,Scone,907171,70732
Northeast,Gifts,Coffee Grinder,509200,40977
Northeast,Gifts,Coffee Pot,590780,46185
Northeast,Gifts,Mug,1144211,91497
Northeast,Gifts,Thermos,604098,48870
Southeast,Coffee,Capuccino,944000,73264
Southeast,Coffee,Espresso,853572,68030
Southeast,Coffee,Latte,2617836,209654
Southeast,Food,Biscotti,1505717,119594
Southeast,Food,Croissant,1902359,156456
Southeast,Food,Scone,900655,73779
Southeast,Gifts,Coffee Grinder,605777,47083
Southeast,Gifts,Coffee Pot,645303,49922
Southeast,Gifts,Mug,1102703,88474
Southeast,Gifts,Thermos,632457,48976
West,Coffee,Capuccino,895495,71168
West,Coffee,Espresso,907617,71675
West,Coffee,Latte,2670405,213920
West,Food,Biscotti,863868,70436
West,Food,Croissant,2425601,197022
West,Food,Scone,912868,72776
West,Gifts,Coffee Grinder,603436,48081
West,Gifts,Coffee Pot,613624,47432
West,Gifts,Mug,1188664,93881
West,Gifts,Thermos,571368,45648
```

Specifying a Record Delimiter

In the following request against the GGSales data source, the field delimiter is a comma, the enclosure character is a single quotation mark, and the record delimiter consists of both printable and non-printable characters, so it is specified as the following hexadecimal sequence:

- 0x: character sequence identifying the delimiter as consisting of hexadecimal character codes.
- 2C: hexadecimal value for comma (,).
- 24: hexadecimal value for dollar sign (\$).

- 0D: hexadecimal value for carriage return.
- 0A: hexadecimal value for new line.

```
TABLE FILE GGSALES
PRINT DOLLARS UNITS CATEGORY REGION
ON TABLE HOLD AS RDELIM1 FORMAT DFIX DELIMITER , ENCLOSURE '''
HEADER NO RDELIMITER 0x2C240D0A
END
```

The generated Master File follows:

```
FILENAME=RDELIM1 , SUFFIX=DFIX , $
SEGMENT=RDELIM1, SEGTYPE=S0, $
  FIELDNAME=DOLLARS, ALIAS=E01, USAGE=I08, ACTUAL=A08, $
  FIELDNAME=UNITS, ALIAS=E02, USAGE=I08, ACTUAL=A08, $
  FIELDNAME=CATEGORY, ALIAS=E03, USAGE=A11, ACTUAL=A11, $
  FIELDNAME=REGION, ALIAS=E04, USAGE=A11, ACTUAL=A11, $
```

The Access File contains the delimiters and enclosure characters:

```
SEGNAME=RDELIM1,
DELIMITER=',',
ENCLOSURE='''',
HEADER=NO,
RDELIMITER=0x2C240D0A,
PRESERVE SPACE=NO, $
```

Each row of the resulting DFIX file ends with the comma-dollar combination and a carriage return and line space. A partial listing follows:

```
20805,1387,'Coffee','Northeast', $
20748,1729,'Coffee','Northeast', $
20376,1698,'Coffee','Northeast', $
20028,1669,'Coffee','Northeast', $
19905,1327,'Coffee','Northeast', $
19470,1770,'Coffee','Northeast', $
19118,1738,'Coffee','Northeast', $
18720,1560,'Coffee','Northeast', $
18432,1536,'Coffee','Northeast', $
17985,1199,'Coffee','Northeast', $
17630,1763,'Coffee','Northeast', $
16646,1189,'Coffee','Northeast', $
15650,1565,'Coffee','Northeast', $
```

```
15450,1545,'Coffee','Northeast',$  
15435,1029,'Coffee','Northeast',$  
14270,1427,'Coffee','Northeast',$
```

Describing a FOCUS Data Source

The following covers data description topics unique to FOCUS data sources:

- **Design tips.** Provides suggestions for designing a new FOCUS data source or changing the design of an existing data source.
- **Describing segments.** Contains information about Master File segment declarations for FOCUS data sources, including defining segment relationships, keys, and sort order using the SEGTYPE attribute, and storing segments in different locations using the LOCATION attribute.
- **Describing fields.** Contains information about Master File field declarations for FOCUS data sources, including the FIND option of the ACCEPT attribute, indexing fields using the INDEX attribute, redefining sequences of fields using the GROUP attribute, and the internal storage requirements of each data type defined by the FORMAT attribute, and of null values described by the MISSING attribute.
- **Describing partitioned data sources.** Contains information about Master File and Access File declarations for intelligently partitioned FOCUS data sources.

Types of FOCUS Data Sources

The type of FOCUS data source you create depends on the amount of storage you require:

- FOCUS data sources with SUFFIX = FOC consist of 4K database pages.
- XFOCUS data sources with SUFFIX = XFOCUS consist of 16K database pages.

The following table lists the usable bytes in a segment in FOCUS and XFOCUS data sources.

Type of Segment	FOCUS Data Source	XFOCUS Data Source
Segment in a single-segment Master File	3968	16284
Root or leaf of a multi segment Master File	3964	16280

Type of Segment	FOCUS Data Source	XFOCUS Data Source
Any other type of segment	3960	16276

Using a SUFFIX=FOC Data Source

The FOCUS data source size can be a maximum of two gigabytes per physical data file. Through partitioning, one logical FOCUS data source can consist of up to 1022 physical files of up to two gigabytes each.

Using an XFOCUS Data Source

The XFOCUS data source is a database structure that parallels the original FOCUS data source, but extends beyond its capabilities with several significant performance and data volume improvements:

- Allows over four times the amount of data per segment instance.
- Holds 16 times as much data in a single physical file - up to 32 gigabytes.
- With the multi-dimensional index (MDI) paradigm, sophisticated indexed searches are possible, with retrieval time improved by as much as 90%. (Performance without the MDI may show only marginal improvement.)

The XFOCUS data source has 16K database pages. The SUFFIX in the Master File is XFOCUS. FOCUS data sources (SUFFIX=FOC) have 4K database pages.

All existing commands that act on FOCUS files work on XFOCUS files. No new syntax is required, except for MDI options.

You can convert to an XFOCUS data source from a FOCUS data source by changing the SUFFIX in the Master File and applying the REBUILD utility.

Specify an XFOCUS Data Source

```
FILE = filename, SUFFIX = XFOCUS, $
```

where:

filename

Can be any valid file name.

Control the Number of Pages Used for XFOCUS Data Source Buffers

FOCUS data sources use buffer pages that are allocated by the BINS setting. Buffer pages for XFOCUS data sources are allocated by the XFOCUSBINS setting

```
SET XFOCUSBINS = n
```

where:

n

Is the number of pages used for XFOCUS data source buffers. Valid values are 16 to 1023. 64 is the default value.

The memory is not actually allocated until an XFOCUS data source is used in the session. Therefore, if you issue the ? SET XFOCUSBINS query command, you will see the number of pages set for XFOCUS buffers and an indication of whether the memory has actually been allocated (passive for no, active for yes).

Create an XFOCUS Data Source

There are two methods for creating an XFOCUS data source. You can either issue the CREATE FILE command or use the HOLD FORMAT XFOCUS command.

Do the following to create an XFOCUS data source using the CREATE FILE command:

Procedure

1. Create a Master File that specifies SUFFIX=XFOCUS.
2. Issue the CREATE FILE command

```
CREATE FILE name
```

where:

name

Is the name of the Master File that specifies SUFFIX=XFOCUS.

Usage Notes for the XFOCUS Data Source

- On mainframe platforms, the LRECL and BLKSIZE are both 16384 (16K).
- The extension on UNIX and Windows is .foc.
- Alphanumeric fields with the format A4096 are supported. They are not limited to A3968 as in SUFFIX=FOC.
- The CALCFILE utility automatically adjusts the calculation algorithm to the suffix type and can be used to size the file.
- The USE command supports 1022 files of mixed XFOCUS and FOC suffixes as long as each type of data source has its own Master File with the correct suffix (FOC for the FOCUS data sources, XFOCUS for the XFOCUS data sources).

Specify USE...AS for the data sources with suffix FOC and another AS for the data sources with suffix XFOCUS in the same USE.

- An attempt to access a SUFFIX=XFOCUS data source with an earlier release causes an error because SUFFIX=XFOCUS is not recognized as a valid value.
- JOIN commands with suffix FOC and suffix XFOCUS data sources are supported. Master File cross-references are supported to other suffix XFOCUS data sources only.
- The COMBINE command supports SUFFIX=XFOCUS data sources. You can COMBINE SUFFIX FOC and XFOCUS in a single COMBINE.

Designing a FOCUS Data Source

The database management system enables you to create sophisticated hierarchical data structures. The following sections provide information to help you design an effective and

efficient FOCUS data source and tell you how you can change the design after the data source has been created.

Data Relationships

The primary consideration when designing a data source is the set of relationships among the various fields. Before you create the Master File, draw a diagram of these relationships. Is a field related to any other fields? If so, is it a one-to-one or a one-to-many relationship? If any of the data already exists in another data source, can that data source be joined to this one?

In general, use the following guidelines:

- All information that occurs once for a given record should be placed in the root segment or a unique child segment.
- Any information that can be retrieved from a joined data source should, in most cases, be retrieved in this way, and not redundantly maintained in two different data sources.
- Any information that has a many-to-one relationship with the information in a given segment should be stored in a descendant of that segment.
- Related data in child segments should be stored in the same path. Unrelated data should be placed in different paths.

The following illustration summarizes the rules for data relationship considerations:

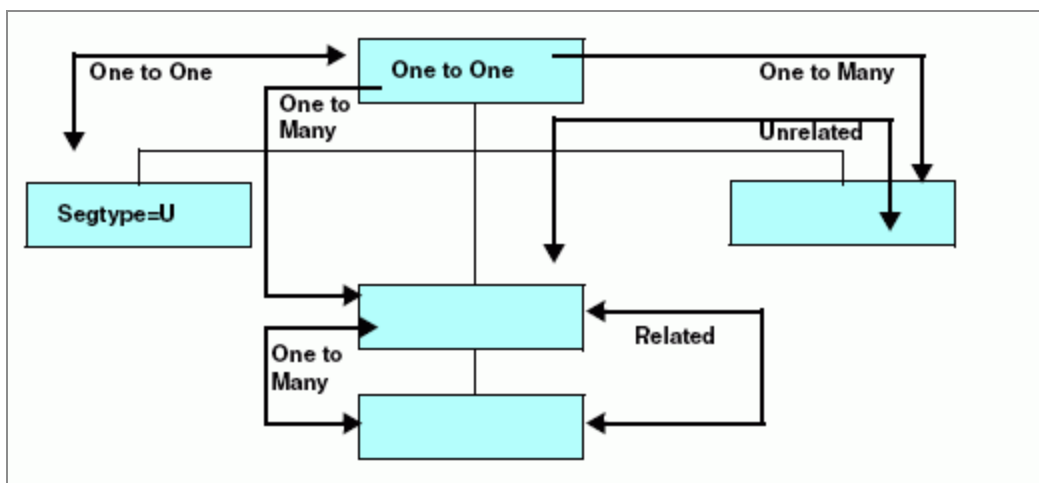

Join Considerations

If you plan to join one segment to another, remember that both the host and cross-referenced fields must have the same format, and the cross-referenced field must be indexed using the INDEX attribute. In addition, for a cross-reference in a Master File, the host and cross-referenced fields must share the same name. The name or alias of both fields must be identical, or else the name of one field must be identical to the alias of the other.

General Efficiency Considerations

A FOCUS data source reads the root segment first, then traverses the hierarchy to satisfy your query. The smaller you make the root segment, the more root segment instances can be read at one time, and the faster records can be selected to process a query.

You can also improve record substitution efficiency by setting AUTOPATH. AUTOPATH is the automation of TABLE FILE *ddname.fieldname* syntax, where the field name is not indexed, and physical retrieval starts at the field name segment. AUTOPATH is described in the *Developing Applications* manual.

As with most information processing issues, there is a trade-off when designing an efficient FOCUS data source: you must balance the desire to speed up record retrieval, by reducing the size of the root segment, against the need to speed up record selection, by placing fields used in record selection tests as high in the data structure as possible. The segment location of fields used in WHERE or IF tests is significant to the processing efficiency of a request. When a field fails a record selection test, there is no additional processing to that segment instance or its descendants. The higher the selection fields are in a data structure, the fewer the number of segments that must be read to determine a record status.

After you have designed and created a data source, if you want to select records based on fields that are low in the data structure, you can rotate the data structure to place those fields temporarily higher by using an alternate view. Alternate views are discussed in [Describing a Group of Fields](#). For details on using alternate views in report requests, see the *FOCUS® Creating Reports* manual.

Use the following guidelines to help you design an efficient data structure:

- Limit the information in the root segment to what is necessary to identify the record and what is used often in screening conditions.

- Avoid unnecessary key fields. Segments with a SEGTYPE of S1 are processed much more efficiently than those with, for example, a SEGTYPE of S9.
- Index the first field of the segment (the key field) if the root segment of your data source is SEGTYPE S1, for increased efficiency in MODIFY procedures that read transactions from unsorted data sources (FIXFORM).
- Use segments with a SEGTYPE of SH1 when adding and maintaining data in date sequence. In this case, a SEGTYPE of SH1 logically positions the most recent dates at the beginning of the data source, not at the end.
- If a segment contains fields frequently used in record selection tests, keep the segment small by limiting it to key fields, selection fields, and other fields frequently used in reports.
- Index the fields on which you perform frequent searches of unique instances. When you specify that a field be indexed, you construct and maintain a table of data values and their corresponding physical locations in the data source. Thus, indexing a field speeds retrieval.

You can index any field you want, although it is advisable to limit the number of indexes in a data source since each index requires additional storage space. You must weigh the increase in speed against the increase in space.

Changing a FOCUS Data Source

After you have designed and created a FOCUS data source, you can change some of its characteristics simply by editing the corresponding attribute in the Master File. The documentation for each attribute specifies whether it can be edited after the data source has been created.

Some characteristics whose attributes cannot be edited can be changed if you rebuild the data source using the REBUILD facility, as described in the *Maintaining Databases* manual. You can also use REBUILD to add new fields to a data source.

Describing a Single Segment

In a segment description, you can describe key fields, sort order, and segment relationships. The number of segments cannot exceed 64 in a FOCUS data source, or 512 in

an XFOCUS data source. This count includes segments plus indexes plus the number of TEXT location files (each TEXT location file can have multiple TEXT fields).

Structures created using JOIN or COMBINE commands can have up to 1024 segments, and FOCUS data sources can participate in join or COMBINE structures that consist of up to 1024 segments.

Using an indexed view reduces the maximum number of segments plus indexes to 191 for the structure being used. If AUTOINDEX is ON, you may be using an indexed view without specifically asking for one.

You can code LOCATION segments in a Master File to expand the file size by pointing to another physical file location.

You can also create a field to timestamp changes to a segment using AUTODATE.

Three additional segment attributes that describe joins between FOCUS segments, CRFILE, CRKEY, and CRSEGNAME, are described in [Defining a Join in a Master File](#).

Describing Keys, Sort Order, and Segment Relationships: SEGTYPE

FOCUS data sources use the SEGTYPE attribute to describe segment key fields and sort order, as well as the relationship of the segment to its parent.

The SEGTYPE attribute is also used with SUFFIX=FIX data sources to indicate a logical key sequence for that data source. SEGTYPE is described in [Describing a Group of Fields](#).

Describe a Segment

The syntax of the SEGTYPE attribute when used for a FOCUS data source is

```
SEGTYPE = segtype
```

Valid values are:

SH[n]

Indicates that the segment instances are sorted from highest to lowest value, based on the value of the first n fields in the segment. n can be any number from 1 to 99. If you do not specify it, it defaults to 1.

S[n]

Indicates that the segment instances are sorted from lowest value to highest, based on the value of the first n fields in the segment. n can be any number from 1 to 255. If you do not specify it, it defaults to 1.

S0

Indicates that the segment has no key field and is therefore not sorted. New instances are added to the end of the segment chain. Any search starts at the current position.

S0 segments are often used to store text for applications where the text needs to be retrieved in the order entered, and the application does not need to search for particular instances.

(blank)

Indicates that the segment has no key field, and is therefore not sorted. New instances are added to the end of the segment chain. Any search starts at the beginning of the segment chain.

SEGTYPE = blank segments are often used in situations where there are very few segment instances, and the information stored in the segment does not include a field that can serve as a key.

Note that a root segment cannot be a SEGTYPE blank segment.

U

Indicates that the segment is unique, with a one-to-one relationship to its parent. Note that a unique segment described with a SEGTYPE of U cannot have any children.

KM

Indicates that this is a cross-referenced segment joined to the data source using a static join defined in the Master File and has a one-to-many relationship to the host segment. Joins defined in the Master File are described in [Defining a Join in a Master File](#). The parent-child pointer is stored in the data source.

KU

Indicates that this is a cross-referenced segment joined to the data source using a static join defined in the Master File, and has a one-to-one relationship to the host segment (that is, it is a unique segment). Joins defined in the Master File are described in [Defining a Join in a Master File](#). The parent-child pointer is stored in the data source.

DKM

Indicates that this is a cross-referenced segment joined to the data source using a dynamic join defined in the Master File, and has a one-to-many relationship to the host segment. Joins defined in the Master File are described in [Defining a Join in a Master File](#). The parent-child pointer is resolved at run time, and therefore new instances can be added without rebuilding.

DKU

Indicates that this is a cross-referenced segment joined to the data source using a dynamic join defined in the Master File, and has a one-to-one relationship to the host segment (that is, it is a unique segment). Joins defined in the Master File are described in [Defining a Join in a Master File](#). The parent-child pointer is resolved at run time, and therefore new instances can be added without rebuilding.

KL

Indicates that this segment is described in a Master File defined join as descending from a KM, KU, DKM, or DKU segment in a cross-referenced data source, and has a one-to-many relationship to its parent.

KLU

Indicates that this segment is described in a Master File defined join as descending from a KM, KU, DKM, or DKU segment in a cross-referenced data source, and has a one-to-one relationship to its parent (that is, it is a unique segment).

Usage Notes for SEGTYPE

Note the following rules when using the SEGTYPE attribute with a FOCUS data source:

- **Alias.** SEGTYPE does not have an alias.
- **Changes.** You can change a SEGTYPE of S[n] or SH[n] to S0 or b, or increase the number of key fields. To make any other change to SEGTYPE, you must use the

REBUILD facility. REBUILD is described in the *Maintaining Databases* manual.

Describing a Key Field

Use the SEGTYPE attribute to describe which fields in a segment are key fields. The values of these fields determine how the segment instances are sequenced. The keys must be the first fields in a segment. You can specify up to 255 keys in a segment that is sorted from low to high (SEGTYPE = S_n), and up to 99 keys in a segment sorted from high to low (SEGTYPE = SH_n). To maximize efficiency, it is recommended that you specify only as many keys as you need to make each record unique. You can also choose not to have any keys (SEGTYPE = S_0 and SEGTYPE = blank).

i Note: Text fields cannot be used as key fields.

Describing Sort Order

For segments that have key fields, use the SEGTYPE attribute to describe the segment sort order. You can sort a segment instances in two ways:

- **Low to high.** By specifying a SEGTYPE of S_n (where n is the number of keys), the instances are sorted using the concatenated values of the first n fields, beginning with the lowest value and continuing to the highest.
- **High to low.** By specifying a SEGTYPE of SH_n (where n is the number of keys), the instances are sorted using the concatenated values of the first n fields, beginning with the highest value and continuing to the lowest.

Segments whose key is a date field often use a high-to-low sort order, since it ensures that the segment instances with the most recent dates are the first ones encountered in a segment chain.

Understanding Sort Order

Suppose the following fields in a segment represent a department code and the employee last name:

06345	19887	19887	23455	21334
Jones	Smith	Frank	Walsh	Brown

If you set SEGTYPE to S1, the department code becomes the key. Note that two records have duplicate key values in order to illustrate a point about S2 segments later in this example. Duplicate key values are not recommended for S1 and SH1 segments. The segment instances are sorted as follows:

06345	19887	19887	21334	23455
Jones	Smith	Frank	Brown	Walsh

If you change the field order to put the last name field before the department code and leave SEGTYPE as S1, the last name becomes the key. The segment instances are sorted as follows:

Brown	Frank	Jones	Smith	Walsh
21334	19887	06345	19887	23455

Alternately, if you leave the department code as the first field, but set SEGTYPE to S2, the segments are sorted first by the department code and then by last name, as follows:

06345	19887	19887	21334	23455
Jones	Frank	Smith	Brown	Walsh

Describing Segment Relationships

The SEGTYPE attribute describes the relationship of a segment to its parent segment:

- Physical one-to-one relationships are usually specified by setting SEGTYPE to U. If a segment is described in a Master File-defined join as descending from the cross-referenced segment, then SEGTYPE is set to KLU in the join description.
- Physical one-to-many relationships are specified by setting SEGTYPE to any valid

value beginning with S (such as S0, SH n , and S n) to blank, or, if a segment is described in a Master File-defined join as descending from the cross-referenced segment, to KL.

- One-to-one joins defined in a Master File are specified by setting SEGTYPE to KU or DKU, as described in [Defining a Join in a Master File](#).
- One-to-many joins defined in a Master File are specified by setting SEGTYPE to KM or DKM, as described in [Defining a Join in a Master File](#).

Storing a Segment in a Different Location: LOCATION

By default, all of the segments in a FOCUS data source are stored in one physical file. For example, all of the EMPLOYEE data source segments are stored in the data source named EMPLOYEE.

Use the LOCATION attribute to specify that one or more segments be stored in a physical file separate from the main data source file. The LOCATION file is also known as a horizontal partition. You can use a total of 64 LOCATION files per Master File (one LOCATION attribute per segment, except for the root). This is helpful if you want to create a data source larger than the FOCUS limit for a single data source file, or if you want to store parts of the data source in separate locations for security or other reasons.

There are at least two cases in which to use the LOCATION attribute:

- Each physical file is individually subject to a maximum file size. You can use the LOCATION attribute to increase the size of your data source by splitting it into several physical files, each one subject to the maximum size limit. (See [Defining a Join in a Master File](#) to learn if it is more efficient to structure your data as several joined data sources.)
- You can also store your data in separate physical files to take advantage of the fact that only the segments needed for a report must be present. Unreferenced segments stored in separate data sources can be kept on separate storage media to save space or implement separate security mechanisms. In some situations, separating the segments into different data sources allows you to use different disk drives.

Divided data sources require more careful file maintenance. Be especially careful about procedures that are done separately to separate data sources, such as backups. For example, if you do backups on Tuesday and Thursday for two related data sources, and

you restore the FOCUS structure using the Tuesday backup for one half and the Thursday backup for the other, there is no way of detecting this discrepancy.

Store a Segment in a Different Location

```
LOCATION = filename [,DATASET = physical_filename]
```

where:

filename

Is the ddname of the file in which the segment is to be stored.

physical_filename

Is the physical name of the data source, dependent on the platform.

Specifying Location for a Segment

The following illustrates the use of the LOCATION attribute:

```
FILENAME = PEOPLE, SUFFIX = FOC, $
SEGNAME = SSNREC,  SEGTYPE = S1, $
  FIELD = SSN,     ALIAS = SOCSEG, USAGE = I9,  $
SEGNAME = NAMEREC, SEGTYPE = U,  PARENT = SSNREC, $
  FIELD = LNAME,  ALIAS = LN,     USAGE = A25, $
SEGNAME = HISTREC, SEGTYPE = S1, PARENT = SSNREC, LOCATION = HISTFILE, $
  FIELD = DATE,   ALIAS = DT,     USAGE = YMD,  $
SEGNAME = JOBREC,  SEGTYPE = S1, PARENT = HISTREC, $
  FIELD = JOBCODE, ALIAS = JC,     USAGE = A3,   $
SEGNAME = SKREC,   SEGTYPE = S1, PARENT = SSNREC, $
  FIELD = SCODE,   ALIAS = SC,     USAGE = A3,   $
```

This description groups the five segments into two physical files, as shown in the following diagram:

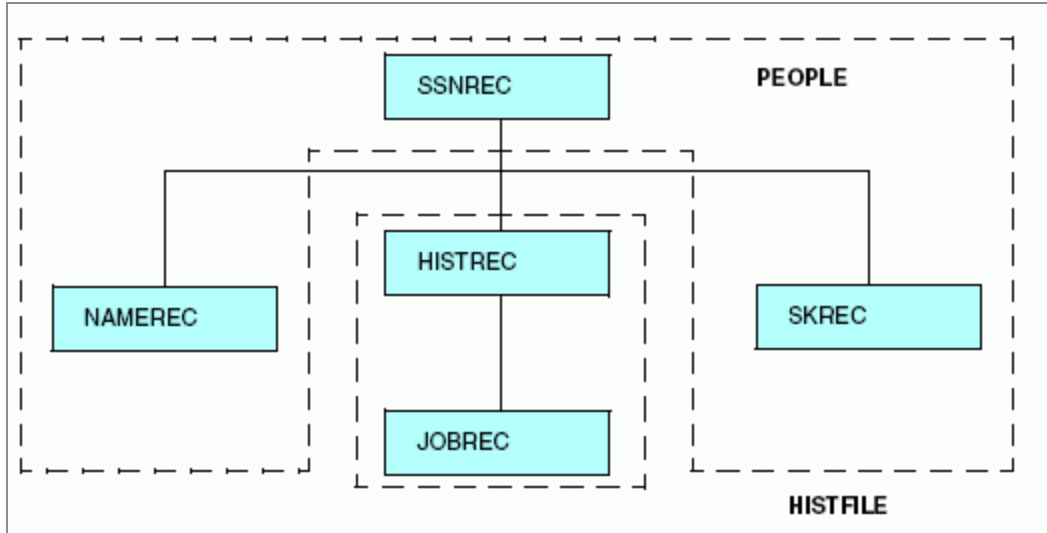

Note that the segment named SKREC, which contains no LOCATION attribute, is stored in the PEOPLE data source. If no LOCATION attribute is specified for a segment, it is placed by default in the same file as its parent. In this example, you can assign the SKREC segment to a different file by specifying the LOCATION attribute in its declaration. However, it is recommended that you specify the LOCATION attribute, and not allow it to default.

Separating Large Text Fields

Text fields, by default, are stored in one physical file with non-text fields. However, as with segments, a text field can be located in its own physical file, or any combination of text fields can share one or several physical files. Specify that you want a text field stored in a separate file by using the LOCATION attribute in the field definition.

For example, the text for DESCRIPTION is stored in a separate physical file named CRSEDESC:

```
FIELD = DESCRIPTION, ALIAS = CDESC, USAGE = TX50, LOCATION = CRSEDESC , $
```

i Note: USAGE may equal TXnnF. "F" is used to format the text field for redisplay when TED is called using ON MATCH or ON NOMATCH in MODIFY. For more information, see the *Maintaining Databases* manual.

If you have more than one text field, each field can be stored in its own file, or several text fields can be stored in one file.

In the following example, the text fields DESCRIPTION and TOPICS are stored in the LOCATION file CRSEDESC. The text field PREREQUISITE is stored in another file, PREREQS.

```
FIELD = DESCRIPTION , ALIAS = CDESC , USAGE = TX50 , LOCATION = CRSEDESC , $
FIELD = PREREQUISITE , ALIAS = PREEQ , USAGE = TX50 , LOCATION = PREREQS , $
FIELD = TOPICS , ALIAS = , USAGE = TX50 , LOCATION = CRSEDESC , $
```

As with segments, you might want to use the LOCATION attribute on a text field if it is very long. However, unlike LOCATION segments, LOCATION files for text fields must be present during a request, whether or not the text field is referenced.

The LOCATION attribute can be used independently for segments and for text fields. You can use it for a text field without using it for a segment. You can also use the LOCATION attribute for both the segment and the text field in the same Master File.

i Note: Field names for text fields in a FOCUS Master File are limited to 12 characters. Field names for text fields in an XFOCUS Master File are not subject to this 12 character limitation. However, for both types of data sources, alias names for these fields can be up to 66 characters.

Limits on the Number of Segments, LOCATION Files, Indexes, and Text Fields

The maximum number of segments in a Master File is 64. There is a limit on the number of different location segments and text LOCATION files you can specify. This limit is based on the number of entries allowed in the File Directory Table (FDT) for FOCUS and XFOCUS data sources. The FDT contains the names of the segments in the data source, the names of indexed fields, and the names of LOCATION files for text fields.

FDT Entries for a FOCUS or XFOCUS Data Source

The FDT can contain 189 entries, of which up to 64 can represent segments and LOCATION files. Each unique LOCATION file counts as one entry in the FDT.

Determine the maximum number of LOCATION files for a data source using the following formula:

```
Available FDT entries = 189 - (Number of Segments + Number of Indexes)
Location files = min (64, Available FDT entries)
```

where:

Location files

Is the maximum number of LOCATION segments and text LOCATION files (up to a maximum of 64).

Number of Segments

Is the number of segments in the Master File.

Number of Indexes

Is the number of indexed fields.

For example, a ten-segment data source with 2 indexed fields enables you to specify up to 52 LOCATION segments and/or LOCATION files for text fields (189 - (10 + 2)). Using the formula, the result equals 177. However, the maximum number of text LOCATION files must always be no more than 64.



Note: If you specify a text field with a LOCATION attribute, the main file is included in the text location file count.

Specifying a Physical File Name for a Segment: DATASET

In addition to specifying a DATASET attribute at the file level in a FOCUS Master File, you can specify the attribute on the segment level to specify the physical file name for a LOCATION segment, or a cross-referenced segment with field redefinitions.

For information on specifying the DATASET attribute at the file level, see [Identifying a Data Source](#).

i Note:

- If you issue a USE command or explicit allocation for the file, a warning is issued that the DATASET attribute will be ignored.
- You cannot use both the ACCESSFILE attribute and the DATASET attribute in the same Master File.
- The MODIFY FIND function is not supported with the DATASET attribute. To use FIND with a data source, you must allocate the data source manually.

The segment with the DATASET attribute must be either a LOCATION segment or a cross-referenced segment. For cross-referenced segments:

- If field declarations are specified for the cross-referenced fields, the DATASET attribute is the only method for specifying a physical file, because the cross-referenced Master File is not read and therefore is not able to pick up its DATASET attribute if one is specified.
- If field declarations are not specified for the cross-referenced fields, it is better to place the DATASET attribute at the file level in the cross-referenced Master File. In this case, specifying different DATASET values at the segment level in the host Master File and the file level of the cross-referenced Master File causes a conflict, resulting in a (FOC1998) message.

If DATASET is used in a Master File whose data source is managed by the FOCUS Database Server, the DATASET attribute is ignored on the server side because the FOCUS Database Server does not read Master Files for servicing table requests.

The DATASET attribute in the Master File has the lowest priority:

- A user explicit allocation overrides DATASET attributes.
- The USE command for FOCUS data sources overrides DATASET attributes and explicit allocations.

i Note: If a DATASET allocation is in effect, you must issue a CHECK FILE command in order to override it by an explicit allocation command. The CHECK FILE command deallocates the allocation created by DATASET.

Use the DATASET Attribute on the Segment Level

For a LOCATION segment:

```
SEGNAME=segname, SEGTYPE=segtype, PARENT=parent, LOCATION=filename,
DATASET='physical_filename [ON sinkname]', $
```

For a cross-referenced segment:

```
SEGNAME=segname, SEGTYPE=segtype, PARENT=parent, [CRSEGNAME=crsegname,]
[CRKEY=crkey,] CRFILE=crfile, DATASET='filename1 [ON sinkname]',
FIELD=...
```

where:

filename

Is the logical name of the LOCATION file.

physical_filename

Is the platform-dependent physical name of the data source.

sinkname

Indicates that the data source is located on the FOCUS Database Server. This attribute is valid for FOCUS data sources.

The syntax is:

```
{DATASET|DATA}='qualifier.qualifier ...'
```

or

```
{DATASET|DATA}='ddname ON sinkname'
```

Allocating a Segment Using the DATASET Attribute

On z/OS:

```
FILE = ...
SEGNAME=BODY, SEGTYPE=S1, PARENT=CARREC, LOCATION=BODYSEG,
  DATASET='USER1.BODYSEG.FOCUS',
  FIELDNAME=BODYTYPE, TYPE, A12, $
  FIELDNAME=SEATS, SEAT, I3, $
  FIELDNAME=DEALER_COST, DCOST, D7, $
  FIELDNAME=RETAIL_COST, RCOST, D7, $
  FIELDNAME=SALES, UNITS, I6, $
```

On z/OS with SU:

```
FILE = ...
SEGNAME=BODY, SEGTYPE=S1, PARENT=CARREC, LOCATION=BODYSEG,
  DATASET='BODYSEG ON MYSU',
  FIELDNAME=BODYTYPE, TYPE, A12, $
  FIELDNAME=SEATS, SEAT, I3, $
  FIELDNAME=DEALER_COST, DCOST, D7, $
  FIELDNAME=RETAIL_COST, RCOST, D7, $
  FIELDNAME=SALES, UNITS, I6, $
```

Timestamping a FOCUS Segment: AUTODATE

Each segment of a FOCUS data source can have a timestamp field that records the date and time of the last change to the segment. This field can have any name, but its USAGE format must be AUTODATE. The field is populated each time its segment instance is updated. The timestamp is stored as the format HYMD5, and can be manipulated for reporting purposes using any of the date-time functions.

In each segment of a FOCUS data source, you can define a field with USAGE = AUTODATE. The AUTODATE field cannot be part of a key field for the segment. Therefore, if the SEGTYPE is S2, the AUTODATE field cannot be the first or second field defined in the segment.

The AUTODATE format specification is supported only for a real field in the Master File, not in a DEFINE or COMPUTE command or a DEFINE in the Master File. However, you can use a DEFINE or COMPUTE command to manipulate or reformat the value stored in the AUTODATE field.

After adding an AUTODATE field to a segment, you must REBUILD the data source. REBUILD does not timestamp the field. It does not have a value until a segment instance is inserted or updated.

If a user-written procedure updates the AUTODATE field, the user-specified value is overwritten when the segment instance is written to the data source. No message is generated to inform the user that the value was overwritten.

The AUTODATE field can be indexed. However, it is recommended that you make sure the index is necessary, because of the overhead needed to keep the index up to date each time a segment instance changes.

If you create a HOLD file that contains the AUTODATE field, it is propagated to the HOLD file as a date-time field with the format HYYMDS.

Define an AUTODATE Field for a Segment

```
FIELDNAME = fieldname, ALIAS = alias, {USAGE|FORMAT} = AUTODATE , $
```

where:

fieldname

Is any valid field name.

alias

Is any valid alias.

Defining an AUTODATE Field

Create the EMPDATE data source by performing a REBUILD DUMP of the EMPLOYEE data source and a REBUILD LOAD into the EMPDATE data source. The Master File for EMPDATE is the same as the Master File for EMPLOYEE, with the FILENAME changed and the DATECHK field added:

```
FILENAME=EMPDATE, SUFFIX=FOC
SEGNAME=EMPINFO, SEGTYPE=S1
FIELDNAME=EMP_ID, ALIAS=EID, FORMAT=A9, $
```

```

FIELDNAME=DATECHK, ALIAS=DATE, USAGE=AUTODATE, $
FIELDNAME=LAST_NAME, ALIAS=LN, FORMAT=A15, $
.
.
.

```

To add the timestamp information to EMPDATE, run the following procedure:

```

SET TESTDATE = 20010715
TABLE FILE EMPLOYEE
PRINT EMP_ID CURR_SAL
ON TABLE HOLD
END
MODIFY FILE EMPDATE
FIXFORM FROM HOLD
MATCH EMP_ID
ON MATCH COMPUTE CURR_SAL = CURR_SAL + 10;
ON MATCH UPDATE CURR_SAL
ON NOMATCH REJECT
DATA ON HOLD
END

```

Then reference the AUTODATE field in a DEFINE or COMPUTE command, or display it using a display command. The following request computes the difference of the number of days between the date 7/31/2001 and the DATECHK field:

```

DEFINE FILE EMPLOYEE
DATE_NOW/HYYMD = DT(20010731);
DIFF_DAYS/D12.2 = HDIFF(DATE_NOW, DATECHK, 'DAY', 'D12.2');
END
TABLE FILE EMPDATE
PRINT DATECHK DIFF_DAYS
WHERE LAST_NAME EQ 'BANNING'
END

```

The output is:

DATECHK	DIFF_DAYS
-----	-----
2001/07/15 15:10:37	16.00

Usage Notes for AUTODATE

- PRINT * and PRINT.SEG.*fld* print the AUTODATE field.
- To display the AUTODATE field on a CRTFORM, Winform, or in FSCAN, you must explicitly reference the AUTODATE field name in the request. CRTFORM * does not display the field. CRTFORM always treats the AUTODATE field as a display-only (D.) field.
- MODIFY FIXFORM and FREEFORM requests capture the system date and time per transaction.
- The FOCUS Database Server updates the AUTODATE field per segment using the date and time on the Server.
- Maintain Data processes AUTODATE fields at COMMIT time.
- DBA is permitted on the AUTODATE field. However, when unrestricted fields in the segment are updated, the system updates the AUTODATE field.
- The AUTODATE field does not support the following attributes: MISSING, ACCEPT, and HELPMESSAGE.

GROUP Attribute

A group provides a convenient alternate name for one or more contiguous fields. The group redefines a sequence of fields and does not require any storage of its own.

Group fields enable you to:

- Join to multiple fields in a cross-referenced data source. Redefine the separate fields as a group, index this group key, and join it to the group field.
- Automatically use indexes in MODIFY when the root segment has multiple indexed fields that comprise the key. In this case you define the group as the key. The SEGTYPE then becomes S1, and MODIFY automatically uses the index.
- Use an indexed view in a TABLE request when records are selected based on an equality test on each component of the group. TABLE only uses one index for this type of retrieval, so you can index the group and enhance retrieval efficiency.

Describing a Group Field With Formats

The component fields can contain alphanumeric or numeric data. However, the group field should always have an alphanumeric format. The length of the group field must be the sum of the actual lengths of the component fields. For example, integer fields always have an actual length of four bytes, regardless of the USAGE format that determines how many characters appear on a report.

Define a Group Field With Formats

```
GROUP=groupname, [ALIAS=groupalias,] USAGE=An, [FIELDTYPE=I,] $
  FIELDNAME=field1, ALIAS=alias1, USAGE=fmt1,$
  FIELDNAME=field2, ALIAS=alias2, USAGE=fmt2,$
  .
  .
  .
  FIELDNAME=fieldn, ALIAS=aliasn, USAGE=fmtn,$
```

where:

groupname

Is the name of the group.

groupalias

Is an optional alias name for the group.

An

Is the format for the group field. Its length is the sum of the internal lengths of the component fields:

- Fields of type I have an internal length of 4.
- Fields of type F have an internal length of 4.
- Fields of type P that have a USAGE format of P15 or P16 or smaller have an internal length of 8, and fields of type P that have a USAGE format of P17 or greater have an internal length of 16.
- Fields of type D have an internal length of 8.

- Fields of type A have an internal length equal to the number of characters (n) in their USAGE formats.

Describing the group field with a format other than A does not generate an error message. However, it is not recommended and may produce unpredictable results.

field1, ..., fieldn

Are the component fields in the group.

alias1, ..., aliasn

Are the alias names for the component fields in the group.

fmt1, ..., fmtn

Are the USAGE formats of the component fields in the group.

FIELDTYPE=I

Creates a separate index for the group.

Usage Notes for Group Fields in FOCUS Data Sources

- When at least one component of the group has a numeric or date format, the group field does not appear correctly. However, the value of the group field is correct, and the individual fields appear correctly. Use this type of group in a TABLE request for indexed retrieval on more than one component field or to join to more than one component field.
- You can add or remove a non-key group field definition in a Master File at any time without impact. If the group field is indexed and you MODIFY the data source without the group field definition in the Master File, you must rebuild the index when you add the group field back to the Master File.
- The MISSING attribute is not supported on a group field.
- To use a group field that contains a numeric component in screening criteria, separate the component values with slashes. However, if the value of one the group components contains a slash '/', the slash may not be used as a delimiter and no test

can be issued against this value.

Note that using slashes makes it easier to specify values when the component fields contain trailing blanks, because you do not have to account for those blanks.

The only masks supported in screening criteria for group fields are those that accept any combination of characters for all group components after the first component. For example, if the FULL_NAME group consists of LAST_NAME and FIRST_NAME, the following mask is supported:

```
WHERE FULL_NAME EQ '$R$$$$$*'
```

- To use a group field that contains only alphanumeric components in screening criteria, separating the component values with a slash is optional.
- A group format supports date display options.
- In MODIFY, you can match on the group field when it is the first field in the segment (S1). A MATCH on a component field in the group without matching on the group generates the following:

```
(FOC439) WARNING. A MATCH CONDITION HAS BEEN ASSUMED FOR:
```

- If the group has an index, and the group components are also indexes, you can MATCH on the group level with no need to match on the group components.
- Although MODIFY enables you to update group components even if they are key fields, this is not recommended. Instead, use SCAN or FSCAN to update key fields.
- If both a group and the field following it are part of a key, the number specified for the SEGTYPE attribute must include the group field plus its component fields, plus the field following the group. For example, if the group key has two components and is followed by another field that is also part of the key, the SEGTYPE must be S4:

```
GROUP = ...,           ,$
  FIELDNAME = FIELDG1, ... ,$
  FIELDNAME = FIELDG2, ... ,$
  FIELDNAME = FIELD3, ... ,$
```

Displaying an Alphanumeric Group Field

In the following group field definition, the group length is 25, the sum of the lengths of the LAST_NAME and FIRST_NAME fields:

```
FILENAME=EMPLOYEE, SUFFIX=FOC
SEGNAME=EMPINFO,  SEGTYPE=S1
  FIELDNAME=EMP_ID,      ALIAS=EID,      FORMAT=A9,      $
  GROUP=FULL_NAME,      ,      FORMAT=A25,      $
  FIELDNAME=LAST_NAME,  ALIAS=LN,      FORMAT=A15,      $
  FIELDNAME=FIRST_NAME, ALIAS=FN,      FORMAT=A10,      $
```

The WHERE test on the group field does not need slashes between the component values, because both component fields are alphanumeric:

```
TABLE FILE EMPLOYEE
PRINT EMP_ID HIRE_DATE
BY FULL_NAME
WHERE FULL_NAME GT 'CROSSBARBARA'
END
```

The output is:

FULL_NAME		EMP_ID	HIRE_DATE
-----		-----	-----
GREENSPAN	MARY	543729165	82/04/01
IRVING	JOAN	123764317	82/01/04
JONES	DIANE	117593129	82/05/01
MCCOY	JOHN	219984371	81/07/01
MCKNIGHT	ROGER	451123478	82/02/02
ROMANS	ANTHONY	126724188	82/07/01
SMITH	MARY	112847612	81/07/01
SMITH	RICHARD	119265415	82/01/04
STEVENS	ALFRED	071382660	80/06/02

Screening on a Group Field With an Integer Component

In the following group field definition, the group length is 29, the sum of the lengths of the LAST_NAME, FIRST_NAME, and HIRE_DATE fields. Because HIRE_DATE is an integer field, its

internal length is 4:

```
FILENAME=EMPLOYEE, SUFFIX=FOC
SEGNAME=EMPINFO,  SEGTYPE=S1
  FIELDNAME=EMP_ID,      ALIAS=EID,      FORMAT=A9,      $
  GROUP=FULL_NAME,      ,      FORMAT=A29,      $
FIELDNAME=LAST_NAME,    ALIAS=LN,      FORMAT=A15,      $
  FIELDNAME=FIRST_NAME,  ALIAS=FN,      FORMAT=A10,      $
  FIELDNAME=HIRE_DATE,   ALIAS=HDT,     FORMAT=I6YMD,   $
```

In the following request, the component field values must be separated by slashes in the WHERE test. The request does not display the group field, because the integer component would not appear correctly:

```
TABLE FILE EMPGROUP
PRINT EMP_ID LAST_NAME FIRST_NAME HIRE_DATE
BY FULL_NAME NOPRINT
WHERE FULL_NAME GT 'CROSS/BARBARA/811102'
END
```

The output is:

EMP_ID	LAST_NAME	FIRST_NAME	HIRE_DATE
543729165	GREENSPAN	MARY	82/04/01
123764317	IRVING	JOAN	82/01/04
117593129	JONES	DIANE	82/05/01
219984371	MCCOY	JOHN	81/07/01
451123478	MCKNIGHT	ROGER	82/02/02
126724188	ROMANS	ANTHONY	82/07/01
112847612	SMITH	MARY	81/07/01
119265415	SMITH	RICHARD	82/01/04
071382660	STEVENS	ALFRED	80/06/02

Describing a Group Field as a Set of Elements

A GROUP declaration in a Master File describes several fields as a single entity. One use of a group is to describe Group keys in a VSAM data source. Sometimes referring to several fields by one group name facilitates ease of reporting.

Traditionally, when describing a GROUP field, you had to take account of the fact that while the USAGE and ACTUAL format for the GROUP field are both alphanumeric, the

length portion of the USAGE format for the group had to be calculated as the sum of the component lengths, where each integer or single precision field counted as 4 bytes, each double precision field as 8 bytes, and each packed field counted as either 8 or 16 bytes depending on its size.

To avoid the need to calculate these lengths, you can use the GROUP ELEMENTS option, which describes a group as a set of elements without USAGE and ACTUAL formats.

Describe a GROUP Field as a Set of Elements

```
GROUP=group1, ALIAS=g1alias,ELEMENTS=n1,$
  FIELDNAME=field11, ALIAS=alias11, USAGE=ufmt11, ACTUAL=afmt11, $
  .
  .
  .
  FIELDNAME=field1h, ALIAS=alias1h, USAGE=ufmt1h, ACTUAL=afmt1h, $
GROUP=group2,ALIAS=g2alias,ELEMENTS=n2,$
  FIELDNAME=field21, ALIAS=alias21, USAGE=ufmt21, ACTUAL=afmt21, $
  .
  .
  .
  FIELDNAME=field2k, ALIAS=alias2k, USAGE=ufmt2k, ACTUAL=afmt2k, $
```

where:

group1, group2

Are valid names assigned to a group of fields. The rules for acceptable group names are the same as the rules for acceptable field names.

n1, n2

Are the number of elements (fields and/or groups) that compose the group. If a group is defined within another group, the subgroup (with all of its elements) counts as one element of the parent group.

field11, field2k

Are valid field names.

alias11, alias2k

Are valid alias names.

ufmt11, ufmt2k

Are USAGE formats for each field.

afmt11, afmt2k

Are ACTUAL formats for each field.

Usage Notes for Group Elements

- To use the ELEMENTS attribute, the GROUP field declaration should specify only a group name and number of elements.
 - If a group declaration specifies USAGE and ACTUAL *without* the ELEMENTS attribute, the USAGE and ACTUAL are accepted as specified, even if incorrect.
 - If a group declaration specifies USAGE and ACTUAL *with* the ELEMENTS attribute, the ELEMENTS attribute takes precedence.
- Each subgroup counts as one element. Its individual fields and subgroups do not count in the number of elements of the parent group.

Declaring a GROUP With ELEMENTS

In the following Master File, GRP2 consists of two elements, fields FIELD A and FIELD B. GRP1 consists of two elements, GRP2 and field FIELD C. Field FIELD D is not part of a group:

```

FILENAME=XYZ      , SUFFIX=FIX      , $
  SEGMENT=XYZ, SEGTYPE=S2, $
  GROUP=GRP1, ALIAS=CCR, ELEMENTS=2, $
    GROUP=GRP2, ALIAS=CC, ELEMENTS=2, $
      FIELDNAME=FIELD A, ALIAS=E01, USAGE=A10, ACTUAL=A10, $
      FIELDNAME=FIELD B, ALIAS=E02, USAGE=A16, ACTUAL=A16, $
      FIELDNAME=FIELD C, ALIAS=E03, USAGE=P27, ACTUAL=A07, $
      FIELDNAME=FIELD D, ALIAS=E04, USAGE=D7, ACTUAL=A07, $
  
```

The following chart shows the offsets and formats of these fields.

Field Number	Field Name	Offset	USAGE	ACTUAL
1	GRP1	0	A42 - Supports 16 characters for FIELDC (P27)	A33
2	GRP2	0	A26	A26
3	FIELDA	0	A10	A10
4	FIELDB	10	A16	A16
5	FIELDC	26	P27	A7
6	FIELDD	42	D7	A7

ACCEPT Attribute

ACCEPT is an optional attribute that you can use to validate data that is entered into a field using a MODIFY procedure. For a description of its use with all types of data sources, see [Describing an Individual Field](#). However, ACCEPT has a special option, FIND, that you can use only with FOCUS data sources. FIND enables you to verify incoming data against values stored in another field.

Specify Data Validation

```
ACCEPT = list
ACCEPT = range
ACCEPT = FIND (sourcefield [AS targetfield] IN file)
```

where:

list

Is a list of acceptable values. See [Describing an Individual Field](#).

range

Gives the range of acceptable values. See [Describing an Individual Field](#).

FIND

Verifies the incoming data against the values in an index in a FOCUS data source.

sourcefield

Is the name of the field to which the ACCEPT attribute is being applied, or any other field in the same segment or path to the segment. This must be the actual field name, not the alias or a truncation of the name.

targetfield

Is the name of the field that contains the acceptable data values. This field must be indexed.

file

Is the name of the file describing the data source that contains the indexed field of acceptable values.

INDEX Attribute

Index the values of a field by including the INDEX attribute, or its alias of FIELDTYPE, in the field declaration. An index is an internally stored and maintained table of data values and locations that speeds retrieval. You must create an index to:

- Join two segments based on equality. The cross-referenced field in a joined FOCUS data source must be indexed, as described in [Describing a Single Segment](#) (for joins defined in a Master File), and the *FOCUS® Creating Reports* manual (for joins defined using the JOIN command). Create an alternate view and make it faster, as described in [Describing a Group of Fields](#).
- Use a LOOKUP function in MODIFY.
- Use a FIND function in MODIFY.
- Speed segment selection and retrieval based on the values of a given field, as described for reporting in the *FOCUS® Creating Reports* manual.

Specify Field Indexing

The syntax of the INDEX attribute in the Master File is:

```
INDEX = I or FIELDTYPE = I
```

Text fields cannot be indexed. The maximum field name length for indexed fields in a FOCUS data source is 12 characters. The maximum field name length for indexed fields in an XFOCUS data source is 66 characters.

Specifying an Index for the JOBCODE Field

```
FIELDNAME = JOBCODE, ALIAS = CJC, FORMAT = A3, INDEX = I, $
```

Joins and the INDEX Attribute

In order to cross reference a segment using a static cross-reference, a dynamic cross-reference, or an equijoin, at least one field in the segment must be indexed. This field, called the cross-referenced field, shares values with a field in the host data source. Only the cross-referenced segment requires an indexed field, shown as follows:

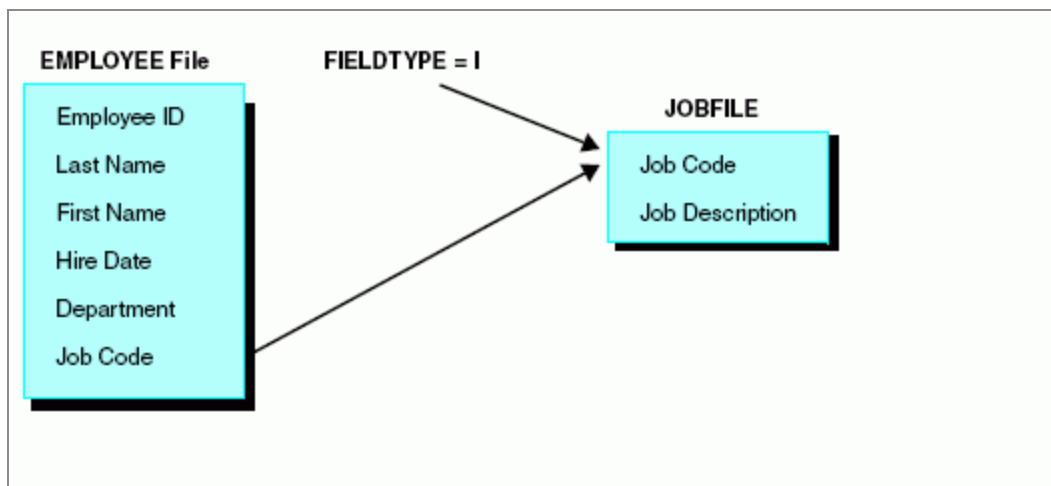

Other data sources locate and use segments through these indexes. Any number of fields may be indexed on a segment, although it is advisable to limit the number of fields you index in a data source.

The value for the field named JOBCODE in the EMPLOYEE data source is matched to the field named JOBCODE in the JOBFIL data source by using the index for the JOBCODE field in the JOBFIL data source, as follows:

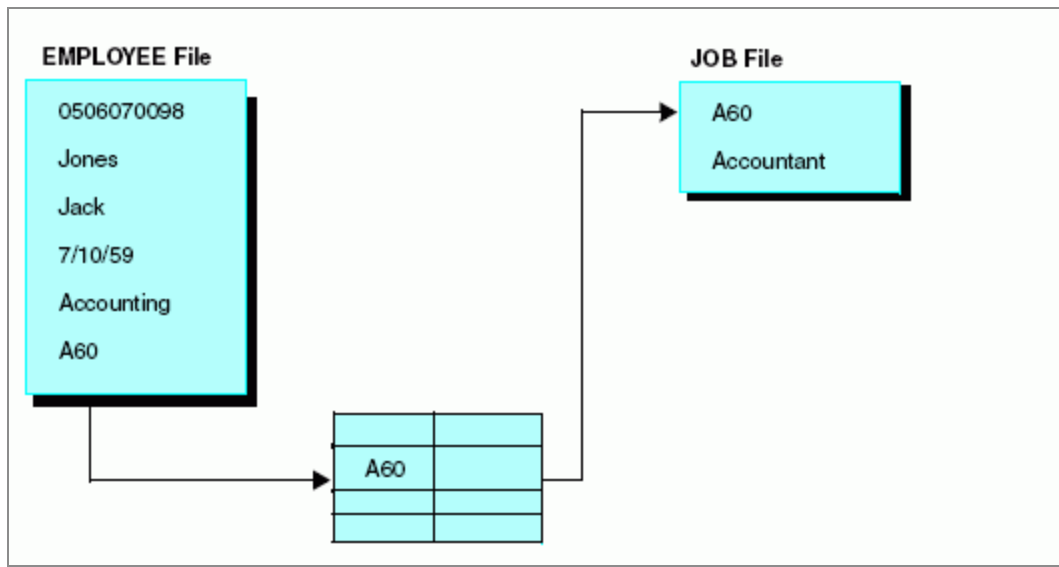

Indexes are stored and maintained as part of the FOCUS data source. The presence of the index is crucial to the operation of the cross-referencing facilities. Any number of external sources may locate and thereby share a segment because of it. New data sources which have data items in common with indexed fields in existing data sources can be added at any time.

Usage Notes for INDEX

Note the following rules when using the INDEX attribute:

- **Alias.** INDEX has an alias of FIELDTYPE.
- **Changes.** If the INDEX attribute is removed from a field, or assigned the equivalent value of blank, the index is longer maintained. If you no longer need the index, use the REORG option of the REBUILD facility to recover space occupied by the index after you remove the INDEX attribute. REBUILD is described in the *Maintaining Databases* manual.

To turn off indexing temporarily (for example, to load a large amount of data into the data source quickly), you can remove the INDEX attribute before loading the data, restore the attribute, and then use the REBUILD command with the INDEX option to create the index. This is known as post-indexing the data source.

You can index the field after the data source has already been created and populated with records, by using the REBUILD facility with the INDEX option.

- **Maximum number.** The total of indexes, text fields, and segments cannot exceed 189 (of which a maximum of 64 can be segments and text LOCATION files).

FORMAT and MISSING: Internal Storage Requirements

Some application developers find it useful to know how different data types and values are represented and stored internally:

- Integer fields are stored as full-word (four byte) binary integers.
- Floating-point double-precision fields are stored as double-precision (eight byte) floating-point numbers.
- Floating-point single-precision fields are stored as single-precision (four byte) floating-point numbers.
- Packed-decimal fields are stored as 8 or 16 bytes and represent decimal numbers with up to 31 digits.
- Date fields are stored as full-word (four byte) binary integers representing the difference between the specified date and the date format base date of December 31, 1900 (or JAN 1901, depending on the date format).
- Date-time fields are stored in 8 or 10 bytes depending on whether the time component specifies microseconds.
- Alphanumeric fields are stored as characters in the specified number of bytes.
- Variable-length alphanumeric fields are stored as characters in the specified number of bytes plus two additional bytes to specify the length of the character string stored in the field.
- Missing values are represented internally by a flag.

Describing a Partitioned FOCUS Data Source

FOCUS data sources can consist of up to 1022 physical files. The horizontal partition is a slice of one or more segments of the entire data source structure. Note, however, that the number of physical files associated with one FOCUS data source is the sum of its partitions and LOCATION files. This sum must be less than or equal to 1022. FOCUS data sources can grow in size over time, and can be repartitioned based on the requirements of the application.

Intelligent Partitioning

The FOCUS data source supports intelligent partitioning, which means that each vertical partition contains the complete data source structure for specific data values or ranges of values. Intelligent partitioning not only lets you separate the data into up to 1022 physical files, it allows you to create an Access File in which you describe the actual data values in each partition using WHERE criteria. When processing a report request, the selection criteria in the request are compared to the WHERE criteria in the Access File to determine which partitions are required for retrieval.

To select applications that can benefit most from partitioning, look for ones that employ USE commands to concatenate data sources, or for data that lends itself to separation based on data values or ranges of values, such as data stored by month or department. Intelligent partitioning functions like an intelligent USE command. It looks at the Access File when processing a report request to determine which partitions to read, whereas the USE command reads all of the files on the list. This intelligence decreases I/O and improves performance.

To take advantage of the partitioning feature, you must:

- Edit the Master File and add the ACCESSFILE attribute.
- Create the Access File using a text editor.

Concatenation of multiple partitions is supported for reporting only. You must load or rebuild each physical partition separately. You can either create a separate Master File for each partition to reference in the load procedure, or you can use the single Master File created for reporting against the partitioned data source, if you:

- Issue an explicit allocation command to link the Master File to each partition in turn.
- Run the load procedure for each partition in turn.

i Note: Report requests automatically read all required partitions without user intervention.

Specifying an Access File in a FOCUS Master File

To take advantage of the partitioning feature, you must edit the Master File and add the ACCESSFILE attribute.

The name of the Access File must be the same as the Master File name, and it must be specified with the ACCESS = attribute in the Master File.

Specify an Access File for a FOCUS Data Source

```
FILENAME=filename, SUFFIX=FOC, ACCESS[FILE]=accessfile,
.
.
.
```

where:

filename

Is the file name of the partitioned data source.

accessfile

Is the name of the Access File. This must be the same as the Master File name.

Master File for the VIDEOTR2 Partitioned Data Source

```
FILENAME=VIDEOTR2, SUFFIX=FOC,
ACCESS=VIDEOTR2, $
SEGNAME=CUST, SEGTYPE=S1
```

```

FIELDNAME=CUSTID,      ALIAS=CIN,           FORMAT=A4,           $
FIELDNAME=LASTNAME,   ALIAS=LN,           FORMAT=A15,          $
FIELDNAME=FIRSTNAME,  ALIAS=FN,           FORMAT=A10,          $
FIELDNAME=EXPDATE,    ALIAS=EXDAT,        FORMAT=YMD,           $
FIELDNAME=PHONE,      ALIAS=TEL,          FORMAT=A10,          $
FIELDNAME=STREET,     ALIAS=STR,          FORMAT=A20,          $
FIELDNAME=CITY,       ALIAS=CITY,         FORMAT=A20,          $
FIELDNAME=STATE,      ALIAS=PROV,         FORMAT=A4,           $
FIELDNAME=ZIP,        ALIAS=POSTAL_CODE, FORMAT=A9,           $
SEGNAME=TRANSDAT, SEGTYPE=SH1, PARENT=CUST
FIELDNAME=TRANSDATE,  ALIAS=OUTDATE,      FORMAT=HYMDI,        $
SEGNAME=SALES,        SEGTYPE=S2, PARENT=TRANSDAT
FIELDNAME=TRANSCODE,  ALIAS=TCOD,         FORMAT=I3,           $
FIELDNAME=QUANTITY,  ALIAS=NO,           FORMAT=I3S,          $
FIELDNAME=TRANSTOT,  ALIAS=TTOT,         FORMAT=F7.2S,        $
SEGNAME=RENTALS,     SEGTYPE=S2, PARENT=TRANSDAT
FIELDNAME=MOVIECODE,  ALIAS=MCOD,         FORMAT=A6, INDEX=I,  $
FIELDNAME=COPY,       ALIAS=COPY,         FORMAT=I2,           $
FIELDNAME=RETURNDATE, ALIAS=INDATE,       FORMAT=YMD,           $
FIELDNAME=FEE,        ALIAS=FEE,          FORMAT=F5.2S,        $
DEFINE DATE/I4 = HPART(TRANSDATE, 'YEAR', 'I4');

```

Using a Partitioned Data Source

The following illustrates how to use an intelligently partitioned data source. The Access File for the VIDEOTR2 data source describes three partitions based on DATE:

```

TABLE FILE VIDEOTR2
PRINT LASTNAME FIRSTNAME DATE
WHERE DATE FROM 1996 TO 1997
END

```

The output is:

LASTNAME	FIRSTNAME	DATE
-----	-----	----
HANDLER	EVAN	1996
JOSEPH	JAMES	1997
HARRIS	JESSICA	1997
HARRIS	JESSICA	1996
MCAHON	JOHN	1996

WU	MARTHA	1997
CHANG	ROBERT	1996

There is nothing in the request or output that signifies that a partitioned data source is used. However, only the second partition is retrieved, reducing I/O and enhancing performance.

Usage Notes for Partitioned FOCUS Data Sources

- Concatenation of multiple partitions in one request is only valid for reporting. To MODIFY or REBUILD a partitioned data source, you must explicitly allocate and MODIFY, Maintain, or REBUILD one partition at a time.
- The order of precedence for allocating data sources is:
 - A USE command that is in effect has the highest precedence. It overrides an Access File or an explicit allocation for a data source.
 - An Access File overrides an explicit allocation for a data source.
- A DATASET attribute cannot be used in the same Master File as an ACCESSFILE attribute.
- Commands that alter a data source (for example, MODIFY, Maintain, and REBUILD) do not use the Access File. If you use a Master File that contains an ACCESSFILE attribute with a command that alters the data source, the following warning message appears:

```
(FOC1968)ACCESS FILE INFORMATION IN MASTER %1 WILL NOT BE
CONSIDERED
```

- The CREATE FILE command automatically issues a dynamic allocation for the data source it creates, and this allocation takes precedence over the ACCESSFILE attribute. In order to use the ACCESSFILE attribute after issuing a CREATE FILE command, you must first free this automatic allocation.
- When the type of command changes from reading a data source to writing to a data source, or vice versa (for example, Maintain to TABLE), the Master File is reparsed.

- When a cross-referenced Master File includes an ACCESSFILE attribute, the host Master File cannot rename the cross-referenced fields.

FOCUS Access File Attributes

Every request supplies the name of a Master File. The Master File is read and the declarations in it are used to access the data source. If the Master File contains an ACCESS= attribute, the Access File is read and used to locate the correct data sources. The Access File must have the same name as the Master File. If there is no Access File with the same name as the ACCESS= attribute in the Master File, the request is processed with the Master File alone.

Access File Attributes for a FOCUS Access File

Each FOCUS Access File describes the files and MDIs for one Master File, and that Master File must have the same file name as the Access File.

All attribute and value pairs are separated by an equal sign (=), and each pair in a declaration is delimited with a comma (,). Each declaration is terminated with the comma dollar sign (,\$).

1. Each Access File starts with a declaration that names its corresponding Master File.
2. Next comes the DATA declaration that describes the location of the physical file. If the file is partitioned, it has multiple DATA declarations.

If the file is *intelligently* partitioned so that an expression describes which data values reside in each partition, the DATA declaration has a WHERE phrase that specifies this expression.

3. If the data source has LOCATION segments the LOCATION declaration names a location segment. Its corresponding DATA declaration points to the physical LOCATION file.
4. If the data source has an MDI, the Access File has an MDI declaration that names the MDI and its target segment, followed by declarations that name the dimensions of the MDI, followed by the MDIDATA declaration that points to the physical MDI file. If the MDI is partitioned, there are multiple MDIDATA declarations for the MDI.

Create a FOCUS Access File

Master File declaration:

```
MASTER=mastername,$
```

where:

mastername

Indicates the name of the Master File with which this Access File is associated. It is the same value included in the Master File ACCESS=filename attribute, used to indicate both the existence of the Access File and its name.

```
DATA=file_specification,
  [WHERE= expression; ,]$
[DATA=file_specification,
  [WHERE= expression; ,]$ ...]
```

where:

file_specification

Points to the file location. This is a complete file specification. There are can be up to 1022 DATA declarations (partitions) in a single Access File. The WHERE clause is the basis of the Intelligent Partitioning feature. The expression is terminated with the semi-colon and the entire declaration with the comma/dollar sign. WHERE expressions of the following type are supported:

```
WHERE= fieldoperatorvalue1 [ OR value2...]; , $
```

```
WHERE= field FROM value1 TO value2 [AND FROM value3 TO value4]; , $
```

Expressions can be combined with the AND operator.

Location File declarations:

```
LOCATION=location_segment_name,
  DATA=location_segment_file_specification,$
```

where:

location_segment_name

Is the name of the segment stored in the location file.

location_segment_file_specification

Is the full file specification for the physical file the segment is located in.

MDI declarations:

```
MDI=mdiname, TARGET_OF = segname,$
  DIM = [filename.]fieldname [, MAXVALUES = n] [, WITHIN = dimname1],$
  [DIM = [filename.]fieldname [, MAXVALUES = n] [, WITHIN = dimname1]
,$ ...]
MDIDATA=mdi_file_specification,$
[MDIDATA=mdi_file_specification,$ ...]
```

where:

mdiname

Is the name of the MDI.

segname

Is the name of the target segment.

filename

Is the name of the file where an MDI dimension resides.

fieldname

Is the name of a field that is a dimension of the MDI.

n

Is the number of distinct values in the dimension. When the MDI is created, the actual dimension value will be converted to an integer of length 1, 2, or 4 bytes, and this number will be stored in the index leaf.

mdi_file_specification

Is the fully-qualified specification of the physical MDI file. If the MDI is partitioned, it is the specification for one partition of the MDI. An MDI can have up to 250 MDIDATA declarations (partitions). An Access File can have an unlimited number of MDIs.

dimname

Defines a hierarchy of dimensions. This dimension is defined within the *dimname* dimension. For example, CITY WITHIN STATE.

Access File for the VIDEOTR2 Data Source

VIDEOTR2 is an intelligently partitioned FOCUS data source. The Master File has an ACCESS=VIDEOTR2 attribute:

```

FILENAME=VIDEOTR2, SUFFIX=FOC, ACCESS=VIDEOTR2
SEGNAME=CUST, SEGTYPE=S1
  FIELDNAME=CUSTID, ALIAS=CIN, FORMAT=A4, $
  FIELDNAME=LASTNAME, ALIAS=LN, FORMAT=A15, $
  FIELDNAME=FIRSTNAME, ALIAS=FN, FORMAT=A10, $
  FIELDNAME=EXPDATE, ALIAS=EXDAT, FORMAT=YMD, $
  FIELDNAME=PHONE, ALIAS=TEL, FORMAT=A10, $
  FIELDNAME=STREET, ALIAS=STR, FORMAT=A20, $
  FIELDNAME=CITY, ALIAS=CITY, FORMAT=A20, $
  FIELDNAME=STATE, ALIAS=PROV, FORMAT=A4, $
  FIELDNAME=ZIP, ALIAS=POSTAL_CODE, FORMAT=A9, $
  FIELDNAME=EMAIL, ALIAS=EMAIL, FORMAT=A18, $
SEGNAME=TRANSDAT, SEGTYPE=SH1, PARENT=CUST
  FIELDNAME=TRANSDATE, ALIAS=OUTDATE, FORMAT=HYMDI,
  MISSING=ON, $
SEGNAME=SALES, SEGTYPE=S2, PARENT=TRANSDAT
  FIELDNAME=TRANSCODE, ALIAS=TCOD, FORMAT=I3, $
  FIELDNAME=QUANTITY, ALIAS=NO, FORMAT=I3S, $
  FIELDNAME=TRANSTOT, ALIAS=TTOT, FORMAT=F7.2S, $
SEGNAME=RENTALS, SEGTYPE=S2, PARENT=TRANSDAT
  FIELDNAME=MOVIECODE, ALIAS=MCOD, FORMAT=A6, INDEX=I, $
  FIELDNAME=COPY, ALIAS=COPY, FORMAT=I2, $
  FIELDNAME=RETURNDATE, ALIAS=INDATE, FORMAT=YMD, $
  FIELDNAME=FEE, ALIAS=FEE, FORMAT=F5.2S, $
DEFINE DATE/I4 = HPART(TRANSDATE, 'YEAR', 'I4');

```

The following shows the Access File, named VIDEOTR2:

```

MASTER=VIDEOTR2 , $
  DATA=USER1.VIDPART1.FOCUS,
  WHERE=DATE EQ 1991; , $

  DATA=USER1.VIDPART2.FOCUS,
  WHERE=DATE FROM 1996 TO 1998; , $

```

```
DATA=USER1.VIDPART3.FOCUS,  
WHERE=DATE FROM 1999 TO 2000;,$
```

Multi-Dimensional Index (MDI)

A multi-dimensional index (MDI) enables you to efficiently and flexibly retrieve information you need for business analysis. It looks at data differently from transaction processing systems in which the goal is to retrieve records based on a key. (FOCUS uses a B-tree index for this type of retrieval). The MDI is for retrieval only. It is not used for MODIFY or Maintain Data requests.

Business analysts may be interested in specific facts (data values, also called measures) about multiple categories of data in the data source. Categories of data, such as region or department, are referred to as dimensions. A multi-dimensional index uses dimensions and all of their hierarchical relationships to point to specific facts.

The MDI is a multi-field index that contains at least two dimensions. This index behaves like a virtual cube of values that intersect at measures of interest. The more dimensions used in a query, the better the retrieval performance.

For example, suppose that the CENTORD data source has an MDI with dimensions STATE, REGION, and PRODCAT. The MDI is used to retrieve the facts (LINEPRICE and QUANTITY data) that lie at the intersection of the dimension values specified in the following request:

```
TABLE FILE CENTORD  
SUM QUANTITY LINEPRICE  
WHERE REGION EQ 'EAST'  
WHERE STATE EQ 'DC'  
WHERE PRODCAT EQ 'Cameras'  
END
```

The MDI also provides the following other retrieval enhancing features: MDI JOIN, Dimensional JOIN, MDI WITHIN, MAXVALUES, MDI Encoding, and AUTOINDEX for MDI.

Specifying an MDI in the Access File

All MDI attributes are specified in the Access File for the data source. The only attribute needed in the Master File is the ACCESSFILE attribute to point to the Access File containing the MDI specifications.

An MDI can be partitioned into multiple MDI files. However, even if the data source on which the MDI is built is partitioned, each MDI partition spans all data source partitions.

Specify an MDI in an Access File

```
MASTER = masterfile,$
  DATA = database_filename1,$
  .
  .
  .
  DATA = database_filenamen , $
  MDI = mdiname,
  TARGET_OF = segname , $
  DIM = field1 [MAXVALUES = n1] [WITHIN = dimname1], $
  .
  .
  .
  DIM = fieldn [MAXVALUES = nn] [WITHIN = dimnamen], $

  MDIDATA = mdifile1 , $
  .
  .
  .
  MDIDATA = mdifilen, $
```

where:

masterfile

Is the Master File name.

database_filename1, ..., database_filenamen

Are fully qualified physical file names in the syntax native to your operating environment. If the name contains blanks or special characters, it must be enclosed in single quotation marks. Multiple DATA declarations describe concatenated partitions.

mdiname

Is the logical name of the MDI, up to 8 characters.

segname

Is the segment that contains the facts pointed to by the MDI. If the target data is distributed among several segments, the target should be the top segment that contains MDI data in order to avoid the multiplicative effect.

field1, ..., fieldn

Are the fields to use as dimensions. At least two dimensions are required for an MDI.

mdifile1, ..., mdifilen

Are fully qualified physical file names for the MDI in the syntax native to your operating environment. If the name contains blanks or special characters, it must be enclosed in single quotation marks. Multiple MDIDATA declarations describe concatenated partitions.

n1, ..., nn

Is the number of distinct values the field can have. This number must be a positive integer.

dimname1, ..., dimnamen

Defines a hierarchy of dimensions. This dimension is defined within the *dimname* dimension. For example, CITY WITHIN STATE.

Defining an MDI

This example shows an MDI with two partitions:

```
MASTER = CAR,$
DATA = USER1.CAR.FOCUS,$
MDI = CARMDI,
  TARGET_OF = ORIGIN,$
  DIM = CAR,$
  DIM = COUNTRY,$
  DIM = MODEL,$
  MDIDATA = USER1.CAR1.MDI,$
  MDIDATA = USER1.CAR2.MDI,$
```

Creating a Multi-Dimensional Index

Each MDI is specified in an Access File for the data source. FOCUS uses the Access File in its retrieval analysis for each TABLE request.

You then use the REBUILD MDINDEX command to build the MDI. The MDI has the following DCB attributes: RECFM=F,LRECL=4096,BLKSIZE=4096.

A multi-dimensional index gives complex queries high-speed access to combinations of dimensions across data sources. If you know what information users want to retrieve and why, you can make intelligent choices about index dimensions.

An Access File can define more than one MDI. If the Access File defines multiple MDIs, the AUTOINDEX facility chooses the best index to use for each query.

The first step in designing an MDI is to find out what kind of information users need from the data source. You can get advice about your MDIs directly from FOCUS.

Choosing Dimensions for Your Index

The choice of index dimensions depends on knowing the data and on analyzing what is needed from it. Examine the record selection (IF and WHERE) tests in your queries to see how many index dimensions each application actually uses to select records. If different applications need different subsets of dimensions, consider separate MDIs for the separate subsets. Although FOCUS can produce high-speed reporting performance with indexes of up to 30 dimensions, smaller indexes usually generate less retrieval overhead. You can create an unlimited number of MDIs.

The following are good candidates for dimensions in an MDI:

- Fields used frequently in record selection tests. Multiple fields used in selection tests within one query belong in the same MDI.
- Fields used as the basis for vertical partitioning, such as date or region.
- Derived dimensions (DEFINE fields) that define a new category based on an existing category. For example, if your data source contains the field STATE but you need a region for your analysis, you can use the STATE field to derive the REGION dimension.
- Fields with many unique values. Fields which have few possible values are not normally good candidates. However, you may want to index such a field if the data source contains very few instances of one of the values, and you want to find those

few instances.

- Packed decimal fields may be used as MDI dimensions on all platforms.
- An MDI can include a field that has a B-tree index as a dimension.
- MDI dimensions support missing values.

Including a field that is updated frequently (such as an AUTODATE field) in the MDI, requires frequent rebuilding of the MDI in order to keep it current. FOCUS can advise you on selecting MDI dimensions.

DEFINE fields described in the Master File can be used as dimensions. Dynamic DEFINE fields cannot be dimensions.

An MDI is for retrieval only. FIND and LOOKUP are not supported on an MDI.

Guidelines for a Multi-Dimensional Index

The following guidelines apply to each MDI:

- The maximum size of an MDI is 200 GB.
- The maximum size of each index partition is 2 GB.
- The total size of all dimensions in an MDI cannot exceed 256 bytes. However, if you include the MAXVALUES attribute in the Access File declaration for a dimension, FOCUS uses a small number of bytes to store the values of that dimension:

MAXVALUES	Number of Bytes Required
1 through 253	1
254 through 65,533	2
Greater than 65,533	4

To allow for expansion, if the maximum number of values is close to a limit, make MAXVALUES big enough to use a larger number of bytes. For example, if you have 250 values, specify 254 for MAXVALUES, and reserve 2 bytes for each dimension value.

Building and Maintaining a Multi-Dimensional Index

The REBUILD command is used to create or maintain a multi-dimensional index. This command can be issued in a FOCUS session or a FOCEXEC.

The best MDI is built by specifying the dimensions in order of best cardinality (most distinct values).

If issued in a FOCUS session, the REBUILD command conducts a dialogue with the user. To issue the REBUILD command in a FOCEXEC, you place the REBUILD command and the user-supplied information needed for REBUILD processing in the FOCEXEC.

If the MDI file might be larger than two gigabytes or if you plan to add more data partitions to it, the MDI index file must be partitioned from the initial REBUILD phase. After the index has been created, you can use it in a retrieval request. You cannot use an MDI for modifying the data source. If you update the data source without rebuilding the MDI and then attempt to retrieve data with it, FOCUS displays a message indicating that the MDI is out of date. You must then rebuild the MDI.

Creating a Multi-Dimensional Index in a FOCUS Session

This example illustrates the creation of an MDI, CARMDI. The Access File contains the following:

```
MASTER = CAR,$
DATA = 'CAR FOCUS A', $
MDI = CARMDI,
  TARGET_OF = ORIGIN,$
  DIM = CAR,$
  DIM = COUNTRY,$
  DIM = MODEL,$
DATA = 'CARMDI MDI A', $
```

The top segment in the CAR data source, segment ORIGIN, is the TARGET_OF segment for the MDI. The following is the REBUILD procedure for the creation of the MDI.

1. Issue REBUILD at the command prompt.

The REBUILD command invokes the REBUILD utility.

The following menu displays:

```
Enter option
1. REBUILD (Optimize the database structure)
2. REORG (Alter the database structure)
3. INDEX (Build/modify the database index)
4. EXTERNAL INDEX (Build/modify an external index database)
5. CHECK (Check the database structure)
6. TIMESTAMP (Change the database timestamp)
7. DATE NEW (Convert old date formats to smartdate formats)
8. MDINDEX (Build/modify a multidimensional index.)
```

2. Enter MDINDEX. The MDINDEX command invokes the MDI option of the REBUILD utility.

The following message appears:

```
NEW/ADD
```

3. Enter NEW. The NEW/ADD option enables you to create a new MDI or to add new data partitions to an existing MDI.

The following message appears:

```
ENTER THE NAME OF THE MASTER
```

4. Enter CAR. The CAR Master File contains the segment that is the TARGET_OF the MDI. The following message appears:

```
ENTER MD_INDEX LOCATION FILE NAME
```

5. Enter CARMDI. CARMDI is the logical name of the CARMDI MDI.

The following message appears:

```
ANY RECORD SELECTION TESTS? (YES/NO)
```

6. Enter NO to indicate that there are no record selection criteria for the index. The user can limit the index to records that meet certain criteria by entering YES, followed by valid record selection expressions, followed by the END command.

Creating a Multi-Dimensional Index in a FOCEXEC

The following FOCEXEC creates the CARMDI MDI and contains each user-supplied value needed for REBUILD processing on a separate line of the FOCEXEC, entered in uppercase:

```
REBUILD
MDINDEX
NEW
CAR
CARMDI
NO
```

Using a Multi-Dimensional Index in a Query

FOCUS allows you to use an MDI in a TABLE or SQL query. The performance is best when all of the dimensions in the MDI are used in selection criteria for the query.

There are two ways to use an MDI with a TABLE query:

- Lazy OR parameters. For example:

```
IF (or WHERE) field EQ value_1 OR value_2 OR value_3. . .
```

- Mask or wildcard characters. For example, the following would show all values for a field that begin with A:

```
IF (or WHERE) field EQ A*
```

where *field* is a dimension in an MDI.

You can use an MDI with an SQL query by issuing an SQL SELECT statement with a WHERE test using a field of an MDI. For example,

```
SELECT field_1, field_2 FROM table WHERE field_3 = value;
```

where *field_3* is a dimension in an MDI.

i Note: AUTOINDEX must be turned on for this feature to be operational.

Querying a Multi-Dimensional Index

FOCUS provides a query command that generates statistics and descriptions for your MDIs. The command ? MDI allows you to display information about MDIs for a given FOCUS/XFOCUS Master File that hosts the target of your MDI.

Query a Multi-Dimensional Index

```
? MDI mastername {mdiname|*} [HOLD [AS holdfile]]
```

where:

mastername

Is the logical name of the Master File. If you do not include any other parameters, a list of all MDI names specified is displayed with the command TARGET_OF in the Access File for this mastername. If the Access File for the mastername does not have any MDI information, a message will display.

mdiname

Is the logical name of an MDI. Specifying this parameter displays all the dimensions that are part of this MDI.

mdiname must be specified as TARGET_OF in the Access File for this *mastername*, or a message will display. If any of the dimensions are involved in a parent-child structure, a tree-like picture will display.

*

Displays a list of all dimensions, by MDI, whose targets are specified inside the Access File for this *mastername*.

HOLD

Saves the output in a text file.

holdfile

Is the file in which the output is saved. If this is not included with the AS phrase, the file is named HOLD.

Using AUTOINDEX to Choose an MDI

When an Access File defines multiple MDIs, retrieval efficiency for a query may become a function of the index it uses to access the data source. The AUTOINDEX facility analyzes each retrieval request and chooses the MDI or B-tree index that provides the best access to the data. You can issue the AUTOINDEX command at the command prompt, in a FOCEXEC, or in a profile. The AUTOINDEX facility can be enabled or disabled. The default is to disable AUTOINDEX, but FOCUS ships with a FOCPARM profile that turns it on when you enter FOCUS.

In its analysis, AUTOINDEX considers the following factors:

- The segment most involved in the query.
- The MDI with the most filtering conditions (IF/WHERE selection tests).
- The percent of index dimensions involved in the request from each MDI.
- How close the fields being retrieved are to the target segment.
- The size of each MDI.

If the selection criteria in a request do not involve any MDI fields, FOCUS looks for an appropriate B-tree index to use for retrieval. If a field is both a B-tree index and a dimension in an MDI, the MDI is used for retrieval if two-thirds of the fields in selection tests are dimensions in the MDI. If it is less than two-thirds, the B-tree index is used. If there are multiple B-tree indexes, the one highest in the hierarchy is used.

If everything else is equal, FOCUS uses the first MDI it finds in the Access File.

Enable or Disable AUTOINDEX for Retrieval

```
SET AUTOINDEX = {ON|OFF}
```

where:

ON

Optimizes MDI retrieval. AUTOINDEX can only be set to ON when the ALL parameter is set to OFF. This value is not the default. However, the FOCPARM file shipped with

FOCUS turns AUTOINDEX ON.

OFF

Disables the AUTOINDEX facility. No MDI will be used for retrieval. This value is the default.



Note:

TABLE requests can automatically turn off AUTOINDEX and select the appropriate index for retrieval by indicating the index name in the request itself:

```
TABLE FILE filename.mdiname
```

You can also assure access with a specific MDI by creating an Access File that describes only that index.

Joining to a Multi-Dimensional Index

Joining to an MDI uses the power of the MDI to produce a fast, efficient join. Instead of joining one field in the source file to an indexed field in the target file, you can join to multiple dimensions of the MDI.

When the join is implemented, the answer set from the source file is created, and the values retrieved for the source fields serve as index values for the corresponding dimensions in the target MDI.

You can join to an MDI in two ways:

- Join to all dimensions of a named MDI (MDI join). In the MDI join, you pick the MDI to use in the join.
- Join certain dimensions in a dimensional join. In this type of join, the JOIN engine picks the most efficient MDI based on the dimensions you choose. The dimensional join supports partial joins.

The source fields must form a one-to-one correspondence with the target dimensions. The MDI engine uses the source field values to get pointers to the target segment of the MDI, expediting data retrieval from the target file.

You can think of the source fields as mirror dimensions. If you put tighter constraints on the mirror dimensions, a smaller answer set is retrieved from the source file, and fewer

index I/Os are required to locate the records from the target file. The speed of the join improves dramatically with the speed of retrieval of the source file answer set. Therefore, you can expedite any TABLE request against the source file by incorporating selection criteria on fields that participate in either a B-tree or MDI.

The following formula computes the time for a TABLE request that uses an MDI Join:

```
Total Time = Time to Retrieve the answer set from the source file (Ts)
+ Time to retrieve the MD index pointers (Tp)
+ Time to retrieve data from the target file (Tt)
```

Using a B-tree index or MDI in data retrieval reduces all types of retrieval time, reducing the total retrieval time.

Join to All Dimensions of a Multi-Dimensional Index

```
JOIN field_1 [AND field_2 ...] IN sfile [TAG tag_1]
TO ALL mdiname IN tfile [TAG tag_2] [AS joinname]
[END]
```

where:

field_1, field_2

Are the join fields from the source file.

sfile

Is the source Master File.

tag_1, tag_2

Are one-character to eight-character names that can serve as unique qualifiers for field names in a request.

mdiname

Is the logical name of the MDI, built on *tfile*, to use in the join.

tfile

Is the target Master File.

joinname

Is a one-character to eight-character join name. A unique join name prevents a subsequent join from overwriting the existing join, allows you to selectively clear the join, and serves as a prefix for duplicate field names in a recursive join.

END

Is required to terminate the JOIN command if it is longer than one line.

Create a Dimensional Join

```
JOIN field_1 [AND field_2 ...] IN sfile [TAG tag_1]  
TO ALL dim_1 [AND dim_2 ...] IN tfile [TAG tag_2] [AS joinname]  
[END]
```

where:

field_1, field_2

Are the join fields from the source file.

sfile

Is the source Master File.

tag_1, tag_2

Are one-character to eight-character names that can serve as unique qualifiers for field names in a request.

dim_1, dim_2

Are dimensions in *tfile*.

tfile

Is the target Master File.

joinname

Is a one-character to eight-character join name. A unique join name prevents a subsequent join from overwriting the existing join, allows you to selectively clear the join, and serves as a prefix for duplicate field names in a recursive join.

END

Is required to terminate the JOIN command if it is longer than one line.

Guidelines for Choosing a Source Field (Dimensional Joins Only)

- A maximum of four mirror and MDI dimensions can participate in a JOIN command.
- The target of the MDI must be a real segment in the target file.
- The order of the mirror dimensions must match the exact physical order of the MDI (target) dimensions.
- The format of each mirror dimension must be identical to that of the corresponding MDI dimension.
- The ALL attribute is required.

Encoding Values in a Multi-Dimensional Index

FOCUS encodes indexed values anytime a field or dimension of an MDI has a MAXVALUES attribute specified or is involved in a parent-child relationship. Encoded values are stored in the MDI file at rebuild time and can be retrieved and decoded with a TABLE request that specifies the MDIENCODING command. The MDIENCODING command allows the user to get output from the MDI file itself without having to read the data source.

Rules for Encoding a Multi-Dimensional Index

The following two rules apply to fields in a TABLE request that uses MDIENCODING:

- Only one MDI can be referred to at a time.
- Only dimensions that are part of the same parent-child hierarchy can be used simultaneously in a request. A dimension that is not part of a parent-child relationship can be used as the field in a request if it has a MAXVALUES attribute.

Retrieve Output From a Multi-Dimensional Index

```
SET MDIENCODING = {ON|OFF}
```

where:

ON

Enables retrieval of output from the MDI file without reading the data source.

OFF

Requires access of the data source to allow retrieval of MDI values.

Encode a Multi-Dimensional Index

```
TABLE FILE mastername.mdiname request  
ON TABLE SET MDIENCODING ON  
END
```

where:

mastername

Is the Master File.

mdiname

Is the logical name of the MDI.

request

Is the TABLE request that decodes the MDI.

Encoding a Multi-Dimensional Index

The following examples show correct MDI encoding:

```
TABLE FILE COMPANY.I DATA1
PRINT CITY BY STATE
ON TABLE SET MDIENCODING ON
END
```

```
TABLE FILE COMPANY.I DATA1
COUNT CITY
IF STATE EQ NY
ON TABLE SET MDIENCODING ON
END
```

```
TABLE FILE COMPANY.I DATA1
PRINT CATEGORY
ON TABLE SET MDIENCODING ON
END
```

The following example is incorrect because CATEGORY is not part of the CITY-STATE hierarchy.

```
TABLE FILE COMPANY.I DATA1
PRINT CITY BY STATE
IF STATE EQ NY
IF CATEGORY EQ RESTAURANT
ON TABLE SET MDIENCODING ON
END
```

Using a Multi-Dimensional Index in a Request

The following TABLE request accesses the CAR data source. It will use the CARMDI index for retrieval because CARMDI is the only MDI described in the Master File:

```

TABLE FILE CAR
SUM RETAIL_COST DEALER_COST
BY BODYTYPE
-* WHERE Condition utilizing MDI fields:
WHERE (COUNTRY EQ 'JAPAN' OR 'ENGLAND')
AND (CAR EQ 'TOYOTA' OR 'JENSEN' OR 'TRIUMPH')
AND (MODEL EQ 'COROLLA 4 DOOR DIX AUTO'
OR 'INTERCEPTOR III' OR 'TR7')
END

```

Partitioning a Multi-Dimensional Index

If the data source has grown due to the addition of new data partitions, and these partitions need to be added to the MDI, you must perform the following steps:

1. Update the Access File to include the new data partitions.
2. Verify that your MDI is partitioned. Remember that the ADD function of the REBUILD utility cannot be executed on a non-partitioned MDI.
3. Perform the REBUILD, MDINDEX, and ADD on the MDI.

Adding a Partition to a Multi-Dimensional Index at the Command Prompt

The following procedure is a REBUILD dialogue:

1. Issue REBUILD at the command prompt. The REBUILD command invokes the REBUILD utility.

The following menu displays:

```

Enter option
1. REBUILD (Optimize the database structure)
2. REORG (Alter the database structure)
3. INDEX (Build/modify the database index)
4. EXTERNAL INDEX (Build/modify an external index database)

```

5. CHECK (Check the database structure)
6. TIMESTAMP (Change the database timestamp)
7. DATE NEW (Convert old date formats to smartdate formats)
8. MDINDEX (Build/modify a multidimensional index.)

2. Enter MDINDEX. This command invokes the MDI option of the REBUILD utility.

The following message appears:

```
NEW/ADD
```

3. Enter ADD. The NEW/ADD option enables you to create a new MDI or to add new data partitions to an existing MDI.

The following message appears:

```
ENTER THE NAME OF THE MASTER
```

4. Enter the name of the Master File. The Master File contains the segment that is the TARGET_OF the MDI.

The following message appears:

```
ENTER MD_INDEX LOCATION FILE NAME
```

5. Enter the logical name of the MDI.

The following message appears:

```
ANY RECORD SELECTION TESTS? (YES/NO)
```

6. Enter NO to indicate that there are no record selection criteria for the index. The user can limit the index to records that meet certain criteria by entering YES, followed by valid record selection expressions, followed by the END command.

Once the MDI is rebuilt to include the new data partitions, any retrieval query that uses the MDI will use the newly added data partitions within that MDI.

Adding a Partition to a Multi-Dimensional Index in a FOCEXEC

The following FOCEXEC contains commands that add a partition to a multi-dimensional index named CARMDI defined on the CAR data source:

```
REBUILD  
MDINDEX  
ADD  
CAR  
CARMDI  
NO
```

After the MDI is rebuilt to include the new data partitions, any retrieval query that uses the MDI will use the newly added data partitions within that MDI.

Querying the Progress of a Multi-Dimensional Index

Use the SET MDIPROGRESS command to view messages about the progress of your MDI build. The messages will show the number of data records accumulated for every n records inserted into the MDI as it is processed.

Query the Progress of a Multi-Dimensional Index

```
SET MDIPROGRESS = {0|n}
```

where:

n

Is an integer greater than 1000, which displays a progress message for every n records accumulated in the MDI build. 100,000 is the default value.

0

Disables progress messages.

Displaying a Warning Message

The SET MDICARDWARN command displays a warning message every time a dimension cardinality exceeds a specified value, offering you the chance to study the MDI build. When the number of equal values of a dimension data reaches a specified percent, a warning message will be issued. In order for MDICARDWARN to be reliable, the data source should contain at least 100,000 records.



Note: In addition to the warning message, a number displays in brackets. This number is the least number of equal values for the dimension mentioned in the warning message text.

Display a Warning Message

```
SET MDICARDWARN = n
```

where:

n

Is a percentage value from 0 to 50.

Defining a Join in a Master File

Describe a new relationship between any two segments that have at least one field in common by joining them. The underlying data structures remain physically separate, but are treated as if they were part of a single structure from which you can report. This section describes how to define a join in a Master File for FOCUS, fixed-format sequential, and VSAM data sources. For information about whether you can define a join in a Master File to be used with other types of data sources, see the appropriate data adapter manual.

Join Types

You can join two data sources in the following ways:

- **Dynamically using the JOIN command.** The join lasts for the duration of the session (or until you clear it during the session) and creates a temporary view of the data that includes all of the segments in both data sources. You can also use the JOIN command to join two data sources of any type, including a FOCUS data source to a non-FOCUS data source. The JOIN command is described in detail in the *FOCUS® Creating Reports* manual.
- **Statically within a Master File.** This method is helpful if you want to access the joined structure frequently. The link (pointer) information needed to implement the join is permanently stored and does not need to be retrieved for each record during each request, saving you time. Like a dynamic Master File defined join, it is always available and retrieves only the segments that you specify. See [Static Joins Defined in the Master File: SEGTYPE = KU and KM](#). This is supported for FOCUS data sources only.
- **Dynamically within a Master File.** This method saves you the trouble of issuing the JOIN command every time you need to join the data sources and gives you flexibility in choosing the segments that will be available within the joined structure. See [Dynamic Joins Defined in the Master File: SEGTYPE = DKU and DKM](#).

- ✔ **Tip:** Some users find it helpful to prototype a database design first using dynamic joins, implemented by issuing the JOIN command or within the Master File. After the design is stable, to change the frequently used joins to static joins defined in the Master File, accelerating data source access. Static joins should be used when the target or cross-referenced data source contents do not change. You can change dynamic joins to static joins by using the REBUILD facility.

- ℹ **Note:** Master File defined joins are sometimes referred to as cross-references.

Static Joins Defined in the Master File: SEGTYPE = KU and KM

Static joins allow you to relate segments in different FOCUS data sources permanently. You specify static joins in the Master File of the host data source.

There are two types of static joins: one-to-one (SEGTYPE KU) and one-to-many (SEGTYPE KM).

- You specify a one-to-one join, also known as a unique join, when you want to retrieve at most one record instance from the cross-referenced data source for each record instance in the host data source.
- You specify a one-to-many join when you want to retrieve any number of record instances from the cross-referenced data source.

Describing a Unique Join: SEGTYPE = KU

In the EMPLOYEE data source, there is a field named JOBCODE in the PAYINFO segment. The JOBCODE field contains a code that specifies the employee job.

The complete description of the job and other related information is stored in a separate data source named JOBFIL. You can retrieve the job description from JOBFIL by locating the record whose JOBCODE corresponds to the JOBCODE value in the EMPLOYEE data source, as shown in the following diagram:

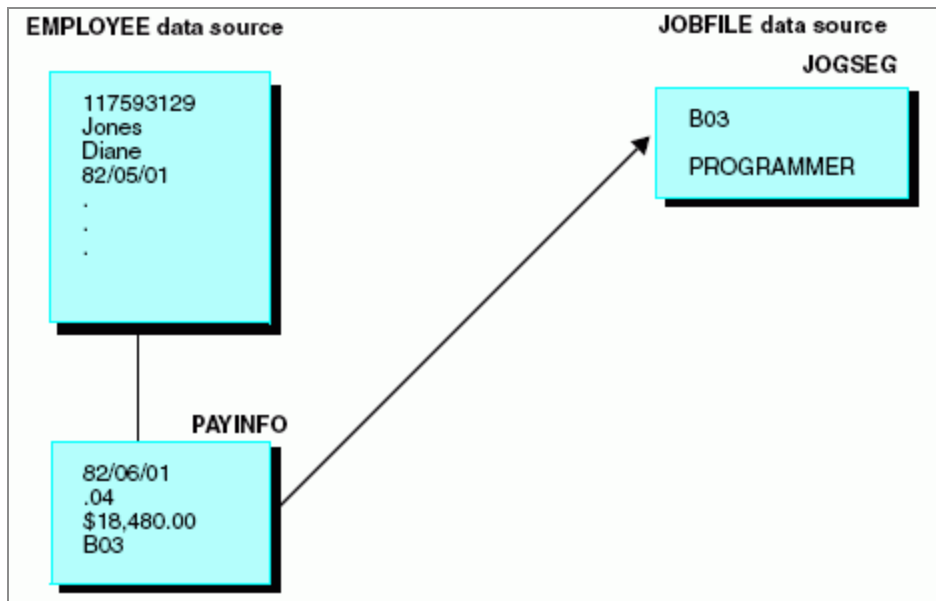

Using a join in this situation saves you the trouble of entering and revising the job description for every record in the EMPLOYEE data source. Instead, you can maintain a single list of valid job descriptions in the JOBFILE data source. Changes need be made only once, in JOBFILE, and are reflected in all of the corresponding joined EMPLOYEE data source records.

Implementing the join as a static join is most efficient because the relationship between job codes and job descriptions is not likely to change.

Although the Employee Information and Job Description segments are stored in separate data sources, for reporting purposes the EMPLOYEE data source is treated as though it also contains the Job Description segment from the JOBFILE data source. The actual structure of the JOBFILE data source is not affected.

The EMPLOYEE data source is viewed as follows:

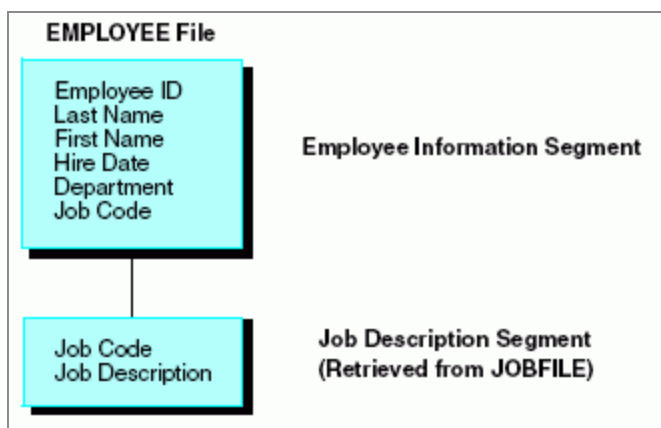

Specify a Static Unique Join

```
SEGNAME = segname, SEGTYPE = KU, PARENT = parent,  
CRFILE = db_name, CRKEY = field, [CRSEGNAME = crsegname,]  
[DATASET = physical_filename,] $
```

where:

segname

Is the name by which the cross-referenced segment will be known in the host data source. You can assign any valid segment name, including the original name of the segment in the cross-referenced data source.

parent

Is the name of the host segment.

db_name

Is the name of the cross-referenced data source. You can change the name without rebuilding the data source.

field

Is the common name (field name or alias) of the host field and the cross-referenced field. The field name or alias of the host field must be identical to the field name of the cross-referenced field. You can change the field name without rebuilding the data source as long as the SEGTYPE remains the same.

Both fields must have the same format type and length.

The cross-referenced field must be indexed (FIELDTYPE=I or INDEX=I).

crsegname

Is the name of the cross-referenced segment. If you do not specify this, it defaults to the value assigned to SEGNAME. After data has been entered into the cross-referenced data source, you cannot change the crsegname without rebuilding the data source.

physical_filename

Optionally, is the platform-dependent physical name of the data source for the CRFILE.

The SEGTYPE value KU stands for keyed unique.

Creating a Static Unique Join

```
SEGNAME = JOBSEG, SEGTYPE = KU, PARENT = PAYINFO,
CRFILE = JOBFILE, CRKEY = JOBCODE, $
```

The relevant sections of the EMPLOYEE Master File follow (nonessential fields and segments are not shown):

```
FILENAME = EMPLOYEE, SUFFIX = FOC, $
SEGNAME = EMPINFO, SEGTYPE = S1, $
.
.
.
SEGNAME = PAYINFO, SEGTYPE = SH1, PARENT = EMPINFO, $
FIELDNAME = JOBCODE, ALIAS = JBC, FORMAT = A3, $
.
.
.
SEGNAME = JOBSEG, SEGTYPE = KU, PARENT = PAYINFO, CRFILE = JOBFILE,
CRKEY = JOBCODE, $
```

Note that you only have to give the name of the cross-referenced segment. The fields in that segment are already known from the cross-referenced data source Master File (JOBFILE in this example). Note that the CRSEGNAME attribute is omitted, since in this example it is identical to the name assigned to the SEGNAME attribute.

The Master File of the cross-referenced data source, as well as the data source itself, must be accessible whenever the host data source is used. There does not need to be any data in the cross-referenced data source.

Using a Unique Join for Decoding

Decoding is the process of matching a code (such as the job code in our example) to the information it represents (such as the job description). Because every code has only one set of information associated with it, the join between the code and the information should be one-to-one, that is, unique. You can decode using a join, as in our example, or using the DECODE function with the DEFINE command, as described in the *FOCUS® Creating Reports* manual. The join method is recommended when there are a large number of codes.

Describing a Non-Unique Join: SEGTYPE = KM

You use a one-to-many join (that is, a non-unique join) when you may have several instances of data in the cross-referenced segment associated with a single instance in the host segment. Using our EMPLOYEE example, suppose that you kept an educational data source named EDUCFILE to track course work for employees. One segment in that data source, ATTNDSEG, contains the dates on which each employee attended a given class. The segment is keyed by attendance date. The EMP_ID field, which identifies the attendees, contains the same ID numbers as the EMP_ID field in the EMPINFO segment of the EMPLOYEE data source.

If you want to see an employee educational record, you can join the EMP_ID field in the EMPINFO segment to the EMP_ID field in the ATTNDSEG segment. You should make this a one-to-many join, since you want to retrieve all instances of class attendance associated with a given employee ID:

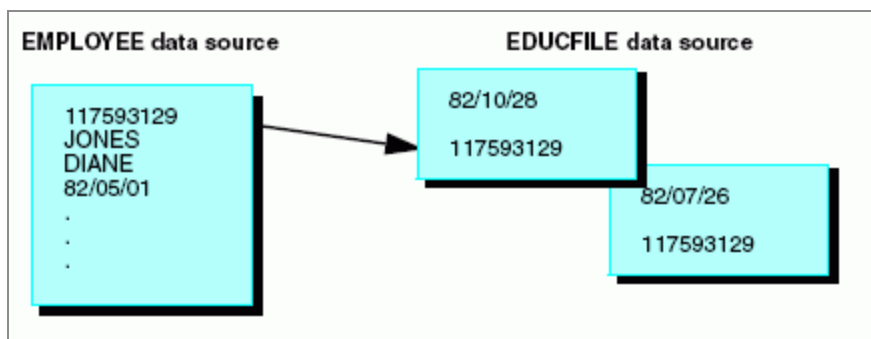

Specify a Static Multiple Join

The syntax for describing one-to-many joins is similar to that for one-to-one joins described in [Specify a Static Unique Join](#), except that you supply a different value, KM (which stands for keyed multiple), for the SEGTYPE attribute, as follows:

```
SEGTYPE = KM
```

Specifying a Static Multiple Join

```
SEGNAME = ATTNDSEG, SEGTYPE = KM, PARENT = EMPINFO,
CRFILE = EDUCFILE, CRKEY = EMP_ID, $
```

The relevant sections of the EMPLOYEE Master File follow (nonessential fields and segments are not shown):

```
FILENAME = EMPLOYEE, SUFFIX = FOC, $
SEGNAME = EMPINFO, SEGTYPE = S1, $
  FIELDNAME = EMP_ID, ALIAS = EID, FORMAT = A9, $
  .
  .
  .
SEGNAME = PAYINFO, SEGTYPE = SH1, PARENT = EMPINFO, $
  FIELDNAME = JOBCODE, ALIAS = JBC, FORMAT = A3, $
  .
  .
  .
SEGNAME = JOBSEG, SEGTYPE = KU, PARENT = PAYINFO, CRFILE = JOBFIL,
  CRKEY = JOBCODE, $
  .
  .
  .
SEGNAME = ATTNDSEG, SEGTYPE = KM, PARENT = EMPINFO, CRFILE = EDUCFILE,
  CRKEY = EMP_ID, $
```

Within a report request, both cross-referenced data sources, JOBFIL and EDUCFILE, are treated as though they are part of the EMPLOYEE data source. The data structure resembles the following:

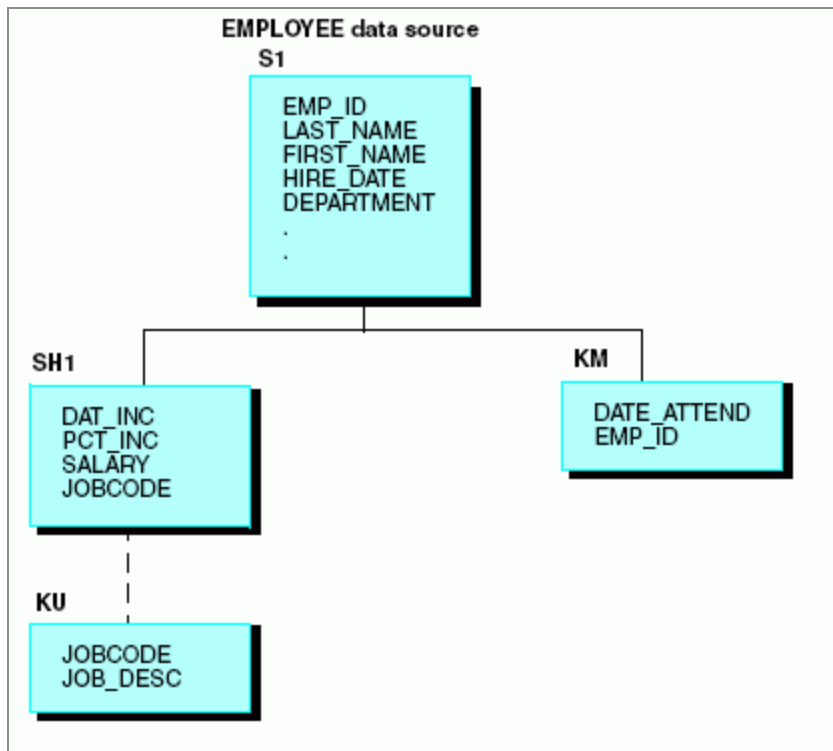

Using Cross-Referenced Descendant Segments: SEGTYPE = KL and KLU

When you join two data sources, you can access any or all of the segments in the cross-referenced data source, not just the cross-referenced segment itself. These other segments are sometimes called linked segments. From the perspective of the host data source, all of the linked segments are descendants of the cross-referenced segment. It is as though an alternate view had been taken on the cross-referenced data source to make the cross-referenced segment the root. To access a linked segment, you only need to declare it in the Master File of the host data source.

Identify Cross-Referenced Descendant Segments

```
SEGNAME = segname, SEGTYPE = {KL|KLU}, PARENT = parentname,  
CRFILE = db_name, [CRSEGNAME = crsegname,]  
[DATASET = physical_filename,] $
```

where:

segname

Is the name assigned to the cross-referenced segment in the host data source.

KL

Indicates that this segment is a descendant segment in a cross-referenced data source (as viewed from the perspective of the host data source), and has a one-to-many relationship to its parent. KL stands for keyed through linkage.

KLU

Indicates that this segment is a descendant segment in a cross-referenced data source (as viewed from the perspective of the host data source), and has a one-to-one relationship to its parent. KLU stands for keyed through linkage, unique.

parentname

Is the name of the segment parent in the cross-referenced data source, as viewed from the perspective of the host data source.

db_name

Is the name of the cross-referenced data source. You can change the name without rebuilding the data source.

crsegname

Is the name of the cross-referenced segment. If you do not specify this, it defaults to the value assigned to SEGNAME.

physical_filename

Optionally, is the platform-dependent physical name of the data source for the CRFILE.

Identifying a Cross-Referenced Descendant Segment

```
SEGNAME = SECSEG,   SEGTYPE = KLU, PARENT = JOBSEG, CRFILE = JOBFILE, $
SEGNAME = SKILLSEG, SEGTYPE = KL,  PARENT = JOBSEG, CRFILE = JOBFILE, $
```

Note that you do not use the CRKEY attribute in a declaration for a linked segment, since the common join field (which is identified by CRKEY) needs to be specified only for the cross-referenced segment.

Using a Cross-Referenced Descendant Segment

Consider our EMPLOYEE example. JOBFILE is a multi-segment data source:

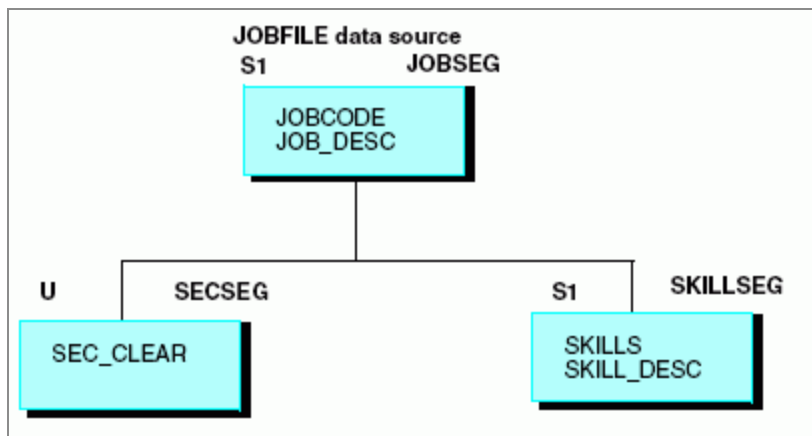

In your EMPLOYEE data source application, you may need the security information stored in the SECSEG segment and the job skill information stored in the SKILLSEG segment. After you have created a join, you can access any or all of the other segments in the cross-referenced data source using the SEGTYPE value KL for a one-to-many relationship (as seen from the host data source), and KLU for a one-to-one relationship (as seen from the host data source). KL and KLU are used to access descendant segments in a cross-referenced data source for both static (KM) and dynamic (DKM) joins.

When the JOBSEG segment is retrieved from JOBFILE, it also retrieves all of the children for JOBSEG that were declared with KL or KLU SEGTYPEs in the EMPLOYEE Master File:

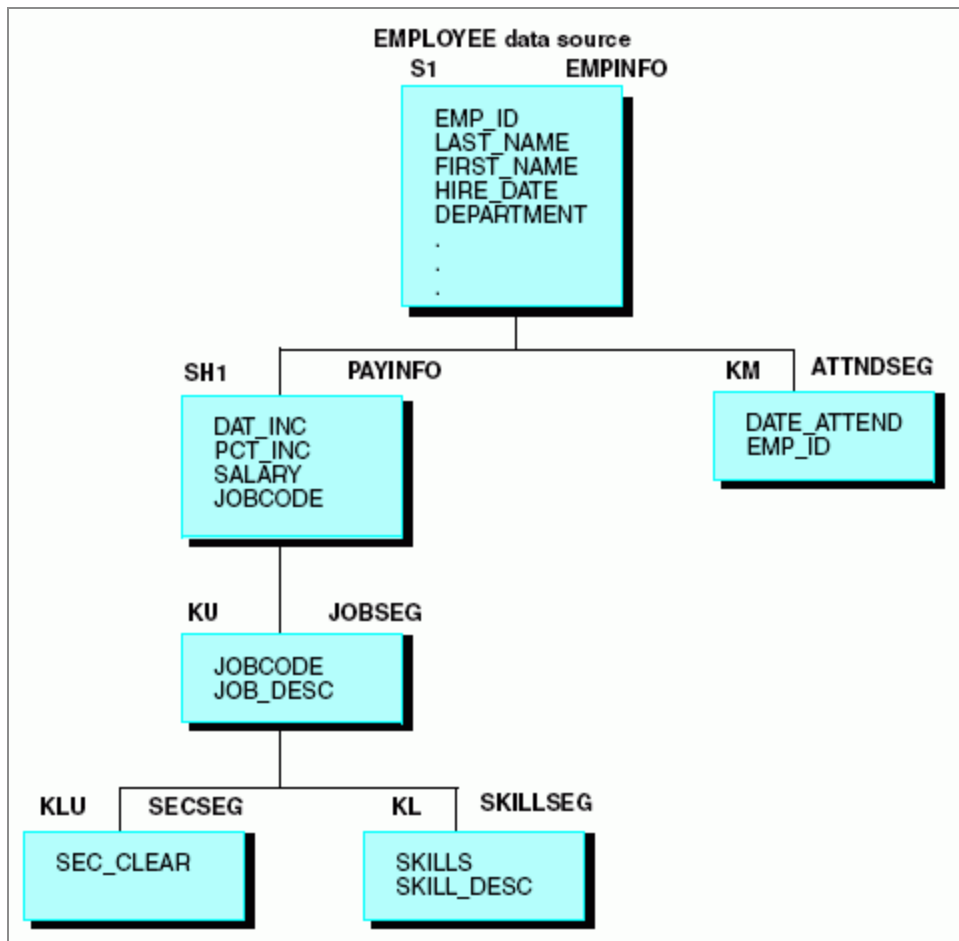

Using a Cross-Referenced Ancestral Segment

Remember that you can retrieve all of the segments in a cross-referenced data source, including both descendants and ancestors of the cross-referenced segment. Ancestor segments should be declared in the host Master File with a SEGTYPE of KLU, as a segment can have only one parent and so, from the perspective of the host data source, this is a one-to-one relationship.

Consider the EDUCFILE data source used in our example. The COURSEG segment is the root and describes each course. ATTNDSEG is a child and includes employee attendance information:

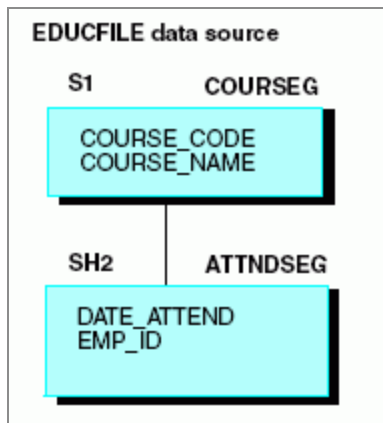

When you join EMPINFO in EMPLOYEE to ATTNDSEG in EDUCFILE, you can access course descriptions in COURSEG by declaring it as a linked segment.

From this perspective, COURSEG is a child of ATTNDSEG, as shown in the following diagram.

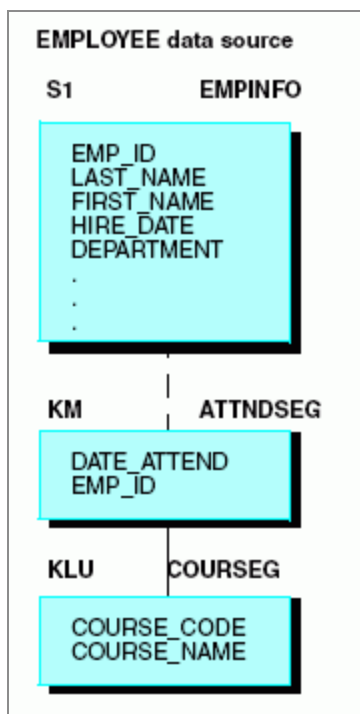

The sections of the EMPLOYEE Master File used in the examples follow (nonessential fields and segments are not shown).

```
FILENAME = EMPLOYEE, SUFFIX = FOC, $
SEGNAME = EMPINFO, SEGTYPE = S1, $
```

```

FIELDNAME = EMP_ID, ALIAS = EID, FORMAT = A9, $
.
.
.
SEGNAME = PAYINFO, SEGTYPE = SH1, PARENT = EMPINFO, $
  FIELDNAME = JOBCODE, ALIAS = JBC, FORMAT = A3, $
.
.
.
SEGNAME = JOBSEG,  SEGTYPE = KU, PARENT = PAYINFO,  CRFILE = JOBFILE,
  CRKEY = JOBCODE, $
SEGNAME = SECSEG,  SEGTYPE = KLU,PARENT = JOBSEG,    CRFILE = JOBFILE, $
SEGNAME = SKILLSEG,SEGTYPE = KL, PARENT = JOBSEG,    CRFILE = JOBFILE, $
SEGNAME = ATTNDSEG,SEGTYPE = KM, PARENT = EMPINFO,   CRFILE = EDUCFILE,
  CRKEY = EMP_ID, $
SEGNAME = COURSEG, SEGTYPE = KLU,PARENT = ATTNDSEG,  CRFILE = EDUCFILE, $

```

Hierarchy of Linked Segments

A KL segment may lead to other KL segments. Graphically, this can be illustrated as:

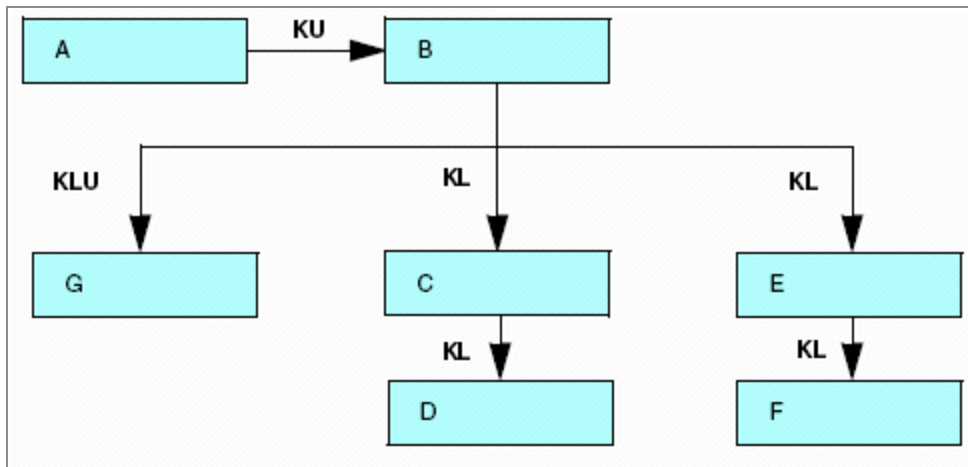

The letters on the arrows are the SEGTYPEs.

Note that segment G may either be a unique descendant of B or the parent of B.

Dynamic Joins Defined in the Master File: SEGTYPE = DKU and DKM

You can define a dynamic join in a Master File using the SEGTYPE attribute. There are two types of dynamic Master File defined joins: one-to-one (SEGTYPE DKU) and one-to-many (SEGTYPE DKM).

- As with a static join, specify a one-to-one join, also known as a unique join, when you want to retrieve at most one record instance from the cross-referenced data source for each record instance in the host data source.
- You specify a one-to-many join when you want to retrieve any number of record instances from the cross-referenced data source.

The difference between static and dynamic joins deals with storage, speed, and flexibility:

- The links (pointers) for a static join are retrieved once and then permanently stored in the host data source (and automatically updated as needed).
- The links for a dynamic join are not saved and need to be retrieved for each record in each report request.

This makes static joins much faster than dynamic ones, but harder to change. You can redefine or remove a static join only using the REBUILD facility. You can redefine or remove a dynamic join at any time by editing the Master File.

Specify a Dynamic Join in a Master File

You specify a dynamic Master File defined join the same way that you specify a static join (as described in [Specify a Static Unique Join](#)), except that the value of the SEGTYPE attribute for the cross-referenced segment is DKU (standing for dynamic keyed unique) for a one-to-one join, and DKM (standing for dynamic keyed multiple) for a one-to-many join.

For example:

```
SEGNAME = JOBSEG, SEGTYPE = DKU, PARENT = PAYINFO,  
CRFILE = JOBFIL, CRKEY = JOBCODE, $
```

You declare linked segments in a dynamic join the same way that you do in a static join. In both cases, SEGTYPE has a value of KLU for unique linked segments, and KL for non-unique linked segments.

Specifying a Dynamic Join in a Master File

The following Master File includes the relevant sections of EMPLOYEE and the segments joined to it, but with the static joins replaced by dynamic joins (nonessential fields and segments are not shown):

```

FILENAME = EMPLOYEE, SUFFIX = FOC, $
SEGNAME = EMPINFO, SEGTYPE = S1, $
    FIELDNAME = EMP_ID, ALIAS = EID, FORMAT = A9, $
    .
    .
    .
SEGNAME = PAYINFO, SEGTYPE = SH1, PARENT = EMPINFO, $
    FIELDNAME = JOBCODE, ALIAS = JBC, FORMAT = A3, $
    .
    .
    .
SEGNAME = JOBSEG, SEGTYPE = DKU, PARENT = PAYINFO, CRFILE = JOBFILE,
    CRKEY = JOBCODE, $
SEGNAME = SECSEG, SEGTYPE = KLU, PARENT = JOBSEG, CRFILE = JOBFILE, $
SEGNAME = SKILLSEG, SEGTYPE = KL, PARENT = JOBSEG, CRFILE = JOBFILE, $
SEGNAME = ATTNDSEG, SEGTYPE = DKM, PARENT = EMPINFO, CRFILE = EDUCFILE,
    CRKEY = EMP_ID, $
SEGNAME = COURSEG, SEGTYPE = KLU, PARENT = ATTNDSEG, CRFILE = EDUCFILE, $

```

Conditional Joins in the Master File

The conditional (or WHERE-based) join describes how to relate rows from two data sources based on any condition. In this type of embedded join, the Master File for one data source contains a cross-reference to the Master File for the other data source. When used to relate non-FOCUS data sources, a conditional embedded join does not require a multi-table Access File.

How to Define a Conditional Join in the Master File

The conditions specified in the join are considered virtual fields in the Master File. You can use the CRJOINTYPE attribute to specify the type of join.

```
FILENAME=filename, SUFFIX=suffix    [,$]
  SEGNAME=file1, SEGTYPE= {S0|KL} [,CRFILE=crfile1] [,$]
    FIELD=name1,...,$
      .
      .
      .
  SEGNAME=seg,  SEGTYPE=styp,  PARENT=parseg,
    CRFILE=xmfd, [CRSEG=xseg, ], [CRJOINTYPE = {INNER|LEFT_OUTER}]
    JOIN_WHERE=expression; [JOIN_WHERE=expression; ...] ,$
```

where:

filename

Is the name of the Master File.

suffix

Is the SUFFIX value.

file1

Is the SEGNAME value for the parent segment.

name

Is any field name.

seg

Is the segment name for the joined segment. Only this segment participates in the join, even if the cross-referenced Master File describes multiple segments.

styp

Is the segment type for the joined segment. Can be DKU, DKM, KU, or KM, as with traditional cross-references in the Master File.

i Note: If you specify a unique join when the relationship between the host and cross-referenced files is one-to-many, the results will be unpredictable.

parseg

Is the parent segment name.

xmfd

Is the cross-referenced Master File.

xseg

Is the cross-referenced segment, if *seg* is not the same name as the SEGNAME in the cross-referenced Master File.

expression

Is any expression valid in a DEFINE FILE command. All of the fields referenced in all of the expressions must lie on a single path.

Using a Conditional Join in the Master File

The following Master File named EMPDATAJ1 defines a conditional join between the EMPDATA and JOBHIST data sources.

```
FILENAME=EMPDATA, SUFFIX=FOC , DATASET=ibisamp/empdata.foc
SEGNAME=EMPDATA, SEGTYPE=S1
FIELDNAME=PIN, ALIAS=ID, FORMAT=A9, INDEX=I, $
FIELDNAME=LASTNAME, ALIAS=LN, FORMAT=A15, $
FIELDNAME=FIRSTNAME, ALIAS=FN, FORMAT=A10, $
FIELDNAME=MIDINITIAL, ALIAS=MI, FORMAT=A1, $
FIELDNAME=DIV, ALIAS=CDIV, FORMAT=A4, $
FIELDNAME=DEPT, ALIAS=CDEPT, FORMAT=A20, $
FIELDNAME=JOBCLASS, ALIAS=CJCLAS, FORMAT=A8, $
FIELDNAME=TITLE, ALIAS=CFUNC, FORMAT=A20, $
FIELDNAME=SALARY, ALIAS=CSAL, FORMAT=D12.2M, $
FIELDNAME=HIREDATE, ALIAS=HDAT, FORMAT=YMD, $
SEGNAME=JOBHIST, PARENT=EMPDATA, SEGTYPE=DKM, CRFILE=ibisamp/jobhist,
CRJOINTYPE=INNER,$
JOIN_WHERE = EMPDATA.JOBCLASS CONTAINS '257' AND JOBHIST.JOBCLASS
CONTAINS '019';$
```

The following request uses the joined Master File.

```
TABLE FILE EMPDATAJ1
SUM SALARY TITLE AS 'Empdata Title' FUNCTITLE AS 'Jobhist Title'
BY LASTNAME
BY FIRSTNAME
BY EMPDATA.JOBCLASS AS 'Empdata Job'
BY JOBHIST.JOBCLASS AS 'Jobhist Job'
WHERE LASTNAME LT 'D'
ON TABLE SET PAGE NOPAGE
  ON TABLE HOLD FORMAT HTML
ON TABLE SET STYLE *
GRID=OFF,$
FONT=ARIAL, SIZE=8,$
TYPE=TITLE, STYLE=BOLD,$
END
```

The following image shows that all of the job class values from the EMPDATA segment start with the characters 257, and all of the job class values from the JOBHIST segment start with the characters 019, as specified in the join condition:

<u>LASTNAME</u>	<u>FIRSTNAME</u>	<u>Empdata Job</u>	<u>Jobhist Job</u>	<u>SALARY</u>	<u>Empdata Title</u>	<u>Jobhist Title</u>
ADAMS	RUTH	257PTB	019PTB	\$250,000.00	MARKETING DIRECTOR	MNGR OF SALESPEOPLE
			019PUA	\$250,000.00	MARKETING DIRECTOR	EXECUTIVE MANAGER
			019PUB	\$62,500.00	MARKETING DIRECTOR	ASST VICE PRESIDENT
			019PVA	\$62,500.00	MARKETING DIRECTOR	INTERNAL VICE PRES
			019PVB	\$62,500.00	MARKETING DIRECTOR	EXEC VICE PRES
BELLA	MICHAEL	257PSB	019PTB	\$250,000.00	INDUSTRIAL MARKETER	MNGR OF SALESPEOPLE
			019PUA	\$250,000.00	INDUSTRIAL MARKETER	EXECUTIVE MANAGER
			019PUB	\$62,500.00	INDUSTRIAL MARKETER	ASST VICE PRESIDENT
			019PVA	\$62,500.00	INDUSTRIAL MARKETER	INTERNAL VICE PRES
			019PVB	\$62,500.00	INDUSTRIAL MARKETER	EXEC VICE PRES
CHISOLM	HENRY	257PRB	019PTB	\$172,000.00	SALES SPECIALIST	MNGR OF SALESPEOPLE
			019PUA	\$172,000.00	SALES SPECIALIST	EXECUTIVE MANAGER
			019PUB	\$43,000.00	SALES SPECIALIST	ASST VICE PRESIDENT
			019PVA	\$43,000.00	SALES SPECIALIST	INTERNAL VICE PRES
			019PVB	\$43,000.00	SALES SPECIALIST	EXEC VICE PRES
CONTI	MARSHALL	257PRA	019PTB	\$129,200.00	ASST MKTG REP	MNGR OF SALESPEOPLE
			019PUA	\$129,200.00	ASST MKTG REP	EXECUTIVE MANAGER
			019PUB	\$32,300.00	ASST MKTG REP	ASST VICE PRESIDENT
			019PVA	\$32,300.00	ASST MKTG REP	INTERNAL VICE PRES
			019PVB	\$32,300.00	ASST MKTG REP	EXEC VICE PRES

Comparing Static and Dynamic Joins

To join two FOCUS data sources, you can choose between two types of joins (static and dynamic) and two methods of defining the join (defined in the Master File and defined by

issuing the JOIN command).

- For a static join, the links, which point from a host segment instance to the corresponding cross-referenced segment instance, are created once and then permanently stored and automatically maintained in the host data source.
- For a dynamic join, the links are retrieved each time needed. This makes static joins faster than dynamic ones, since the links only need to be established once, but less flexible, as you can redefine or remove a static join only by using the REBUILD facility or reloading the file with MODIFY or Maintain Data.

Among dynamic joins, the JOIN command is easier to use in that you do not need to edit the Master File each time you want to change the join specification, and you do not need to describe each linked segment as it appears from the perspective of the host data source. On the other hand, Master File defined dynamic joins enable you to omit unnecessary cross-referenced segments.

You may find it efficient to implement frequently used joins as static joins. You can change static joins to dynamic, and dynamic to static, using the REBUILD facility.

The following chart compares implementing a static join defined in a Master File, a dynamic join defined in a Master File, and a dynamic join defined by issuing the JOIN command.

Join Type	Advantages	Disadvantages
Static Join in Master File (SEGTYPE = KU or KM)	Faster after first use. Links are created only once. Always in effect. Can select some linked segments and omit others.	Must be specified before the data source is created or reloaded using REBUILD. Requires REBUILD facility to change. Requires four bytes of file space per instance. User needs to know how to specify relationships for linked segments (KL, KLU).
Dynamic Join in Master File	Can be specified at any time.	Slower. Links are retrieved for each record in each report request.

Join Type	Advantages	Disadvantages
(SEGTYPE =DKU or DKM)	<p>Always in effect. Does not use any space in the data source.</p> <p>Can be changed or removed as needed, without using the REBUILD facility.</p> <p>Can select some linked segments and omit others.</p>	<p>User needs to know how to specify relationships for linked segments (KL, KLU).</p>
Dynamic Join (using the JOIN Command)	<p>Can be specified at any time.</p> <p>Does not use any space in the data source. Can be changed or removed as needed, without using the REBUILD facility.</p> <p>User never needs to describe the relationships of linked segments.</p>	<p>Slower. Links are retrieved for each record in each report request.</p> <p>JOIN command must be issued in each session in which you want the join to be in effect.</p> <p>All segments in the target are always included, whether or not you need them.</p>

Joining to One Cross-Referenced Segment From Several Host Segments

You may come upon situations where you need to join to one cross-referenced segment from several different segments in the host data source. You may also find a need to join to one cross-referenced segment from two different host data sources at the same time. You can handle these data structures using Master File defined joins.

Joining From Several Segments in One Host Data Source

In an application, you may want to use the same cross-referenced segment in several places in the same data source. Suppose, for example, that you have a data source named COMPFILE that maintains data on companies you own:

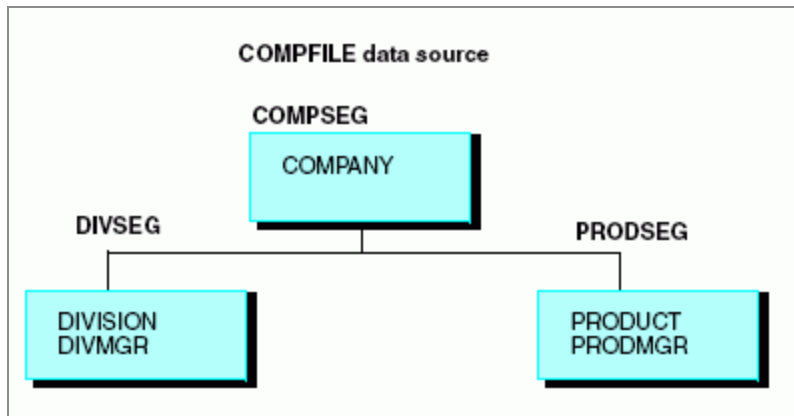

The DIVSEG segment contains an instance for each division and includes fields for the name of the division and its manager. Similarly, the PRODSEG segment contains an instance for each product and the name of the product manager.

Retrieve personal information for both the product managers and the division managers from a single personnel data source, as shown below:

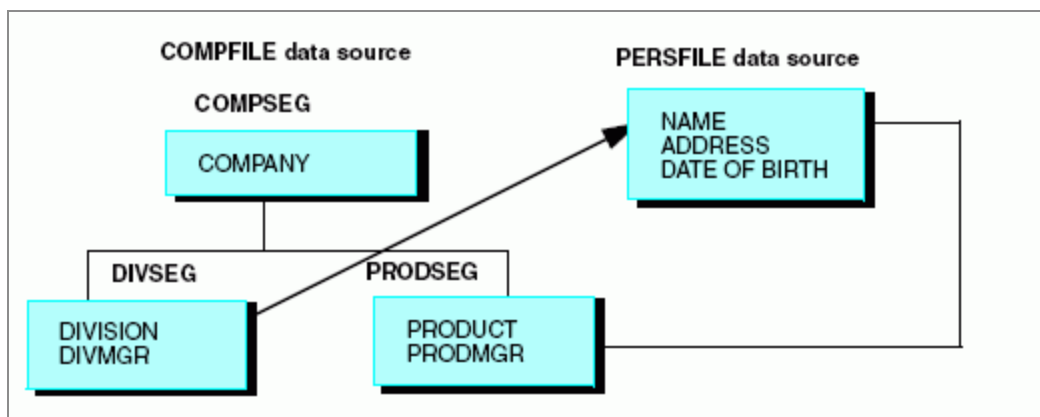

You cannot retrieve this information with a standard Master File defined join because there are two cross-reference keys in the host data source (PRODMGR and DIVMGR) and in your reports you will want to distinguish addresses and dates of birth retrieved for the PRODSEG segment from those retrieved for the DIVSEG segment.

A way is provided for you to implement a join to the same cross-referenced segment from several segments in the one host data source. You can match the cross-referenced and host fields from alias to field name and uniquely rename the fields.

The Master File of the PERSFILE could look like this:

```
FILENAME = PERSFILE, SUFFIX = FOC, $
SEGNAME = IDSEG, SEGTYPE = S1, $
FIELD = NAME, ALIAS = FNAME, FORMAT = A12, INDEX=I, $
FIELD = ADDRESS, ALIAS = DAS, FORMAT = A24, $
FIELD = DOB, ALIAS = IDOB, FORMAT = YMD, $
```

You use the following Master File to join PERSFILE to COMPFIL. Note that there is no record terminator (\$) following the cross-referenced segment declaration (preceding the cross-referenced field declarations).

```
FILENAME = COMPFIL, SUFFIX = FOC, $
SEGNAME = COMPSEG, SEGTYPE = S1, $
FIELD = COMPANY, ALIAS = CPY, FORMAT = A40, $
SEGNAME = DIVSEG, PARENT = COMPSEG, SEGTYPE = S1, $
FIELD = DIVISION, ALIAS = DV, FORMAT = A20, $
FIELD = DIVMGR, ALIAS = NAME, FORMAT = A12, $
SEGNAME = ADSEG, PARENT = DIVSEG, SEGTYPE = KU,
CRSEGNAME = IDSEG, CRKEY = DIVMGR, CRFILE = PERSFILE,
FIELD = NAME, ALIAS = FNAME, FORMAT = A12, INDEX = I,$
FIELD = DADDRESS, ALIAS = ADDRESS, FORMAT = A24, $
FIELD = DDOB, ALIAS = DOB, FORMAT = YMD, $
SEGNAME = PRODSEG, PARENT = COMPSEG, SEGTYPE = S1, $
FIELD = PRODUCT, ALIAS = PDT, FORMAT = A8, $
FIELD = PRODMGR, ALIAS = NAME, FORMAT = A12, $
SEGNAME = BDSEG, PARENT = PRODSEG, SEGTYPE = KU,
CRSEGNAME = IDSEG, CRKEY = PRODMGR, CRFILE = PERSFILE,
FIELD = NAME, ALIAS = FNAME, FORMAT = A12, INDEX = I,$
FIELD = PADDRESS, ALIAS = ADDRESS, FORMAT = A24, $
FIELD = PDOB, ALIAS = DOB, FORMAT = YMD, $
```

DIVMGR and PRODMGR are described as CRKEYs. The common alias, NAME, is automatically matched to the field name NAME in the PERSFILE data source. In addition, the field declarations following the join information rename the ADDRESS and DOB fields to be referred to separately in reports. The actual field names in PERSFILE are supplied as aliases.

Note that the NAME field cannot be renamed since it is the common join field. It must be included in the declaration along with the fields being renamed, as it is described in the cross-referenced data source. That it cannot be renamed is not a problem, since its ALIAS

can be renamed and the field does not need to be used in reports. Because it is the join field, it contains exactly the same information as the DIVMGR and PRODMGR fields.

The following conventions must be observed:

- The common join field FIELDNAME or ALIAS in the host data source must be identical to its FIELDNAME in the cross-referenced data source.
- The common join field should not be renamed, but the alias can be changed. The other fields in the cross-referenced segment can be renamed.
- Place field declarations for the cross-referenced segment after the cross-referencing information in the Master File of the host data source, in the order in which they actually occur in the cross-referenced segment. Omit the record terminator (\$) at the end of the cross-referenced segment declaration in the host Master File, as shown:

```
SEGNAME = BDSEG, PARENT = PRODSEG, SEGTYPE = KU,
CRSEGNAME = IDSEG, CRKEY = PRODMGR, CRFILE = PERSFILE,
FIELD = NAME, ALIAS = FNAME, FORMAT = A12 ,INDEX=I, $
FIELD = PADDRESS, ALIAS = ADDRESS, FORMAT = A24 , $
FIELD = PDOB, ALIAS = DOB, FORMAT = YMD , $
```

Joining From Several Segments in Several Host Data Sources: Multiple Parents

At some point, you may need to join to a cross-referenced segment from two different host data sources at the same time. If you were to describe a structure like this as a single data source, you would have to have two parents for the same segment, which is invalid. You can, however, describe the information in separate data sources, using joins to achieve a similar effect.

Consider an application that keeps track of customer orders for parts, warehouse inventory of parts, and general part information. If this were described as a single data source, it would be structured as follows:

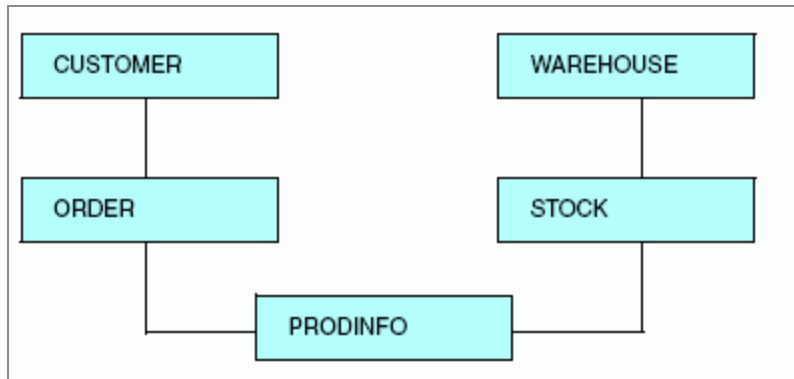

You can join several data sources to create this structure. For example:

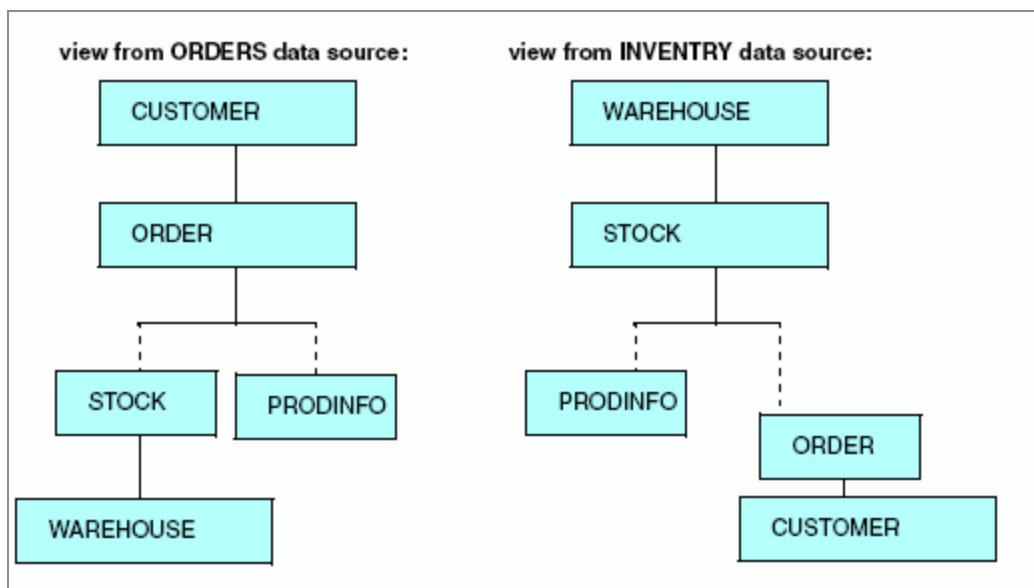

The CUSTOMER and ORDER segments are in the ORDERS data source, the WAREHOUSE and STOCK segments are in the INVENTORY data source, and the PRODINFO segment is stored in the PRODUCTS data source. Both the INVENTORY and ORDERS data sources have one-to-one joins to the PRODUCTS data source. In the INVENTORY data source, STOCK is the host segment. In the ORDERS data source, ORDER is the host segment.

In addition, there is a one-to-many join from the STOCK segment in the INVENTORY data source to the ORDER segment in the ORDERS data source, and a reciprocal one-to-many join from the ORDER segment in the ORDERS data source to the STOCK segment in the INVENTORY data source.

The joins among these three data sources can be viewed from the perspectives of both host data sources, approximating the multiple-parent structure described earlier.

Recursive Reuse of a Segment

In rare cases, a data source may cross-reference itself. Consider the case of a data source of products, each with a list of parts that compose the product, where a part may itself be a product and have subparts. Schematically, this would appear as:

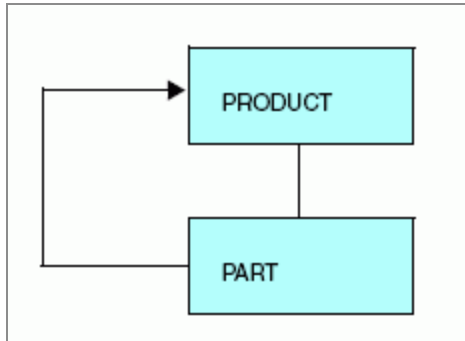

A description for this case, shown for two levels of subparts, is:

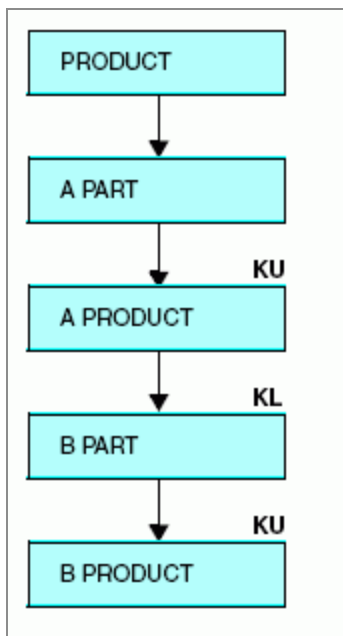

See the *FOCUS® Creating Reports* manual for more information on recursive joins.

Creating a Single-Root Cluster Master File

A cluster Master File is a Master File in which different segments describe separate data sources, which may be of varying types. The SEGSUF attribute specifies the suffix for a

specific segment, if it is different from the SUFFIX for the top segment.

i Note: A FOCUS segment cannot be the top segment in a cluster Master File with varying SUFFIX values.

Reading a Field Containing Delimited Values as individual Rows

A field that contains a list of delimited values (such as email addresses separated by spaces) can be pivoted to be read as individual rows, when an additional segment is added with SEGSUF=DFIX (Delimited Flat File).

Read a Field Containing Delimited Values as Individual Rows

In the Master File, add a segment definition with SEGTYPE=S0, SEGSUF=DFIX, and a POSITION attribute that points to the field with delimited values.

```

SEGNAME=parentseg, SUFFIX=suffix, SEGTYPE=S1,$
FIELD=FIELD1, ..., $
FIELD=delimitedfield, ALIAS=alias1, USAGE=fmt, ACTUAL=afmt,$
...
SEGNAME=dfixsegname, PARENT=parentseg, SEGSUF=DFIX,
POSITION=delimitedfield,$
FIELD=name, ALIAS=alias2, USAGE=fmt, ACTUAL=afmt,$
...

```

Create an Access File that specifies the row delimiter and any other DFIX attributes for the DFIX segment.

```

SEGNAME=dfixsegname, RDELIMITER='delimiter', $

```

where:

delimitedfield

Is the name of the delimited field.

alias1

Is the alias of the delimited field.

fmt

Is the USAGE format for the delimited field.

afmt

Is the ACTUAL format for the delimited field.

dfixsegname

Is the segment name of the added segment definition for the DFIX field.

parentseg

Is the name of the segment that actually contains the delimited field.

name

Is the name for the pieces of the delimited field.

alias2

Is the alias for the pieces of the delimited field.

delimiter

Is the delimiter in the DFIX field.

When you issue a request, the field will be treated as separate rows based on the delimiter.

Reading a Field Containing Delimited Values as Individual Rows

The following file named COUNTRYL.FTM contains country names and the longitude and latitude values of their capitals, The longitude and latitude values are stored as a single field named LNGLAT, separated by a comma:

Argentina	-64.0000000,-34.0000000
Australia	133.0000000,-27.0000000
Austria	13.3333000,47.3333000
Belgium	4.0000000,50.8333000
Brazil	-55.0000000,-10.0000000
Canada	-95.0000000,60.0000000
Chile	-71.0000000,-30.0000000
China	105.0000000,35.0000000
Colombia	-72.0000000,4.0000000
Denmark	10.0000000,56.0000000
Egypt	30.0000000,27.0000000
Finland	26.0000000,64.0000000
France	2.0000000,46.0000000
Germany	9.0000000,51.0000000
Greece	22.0000000,39.0000000
Hungary	20.0000000,47.0000000
India	77.0000000,20.0000000
Ireland	-8.0000000,53.0000000
Israel	34.7500000,31.5000000
Italy	12.8333000,42.8333000
Japan	138.0000000,36.0000000
Luxembourg	6.1667000,49.7500000
Malaysia	112.5000000,2.5000000
Mexico	-102.0000000,23.0000000
Netherlands	5.7500000,52.5000000
Norway	10.0000000,62.0000000
Philippines	122.0000000,13.0000000
Poland	20.0000000,52.0000000
Portugal	-8.0000000,39.5000000
Singapore	103.8000000,1.3667000
South Africa	24.0000000,-29.0000000
South Korea	127.5000000,37.0000000
Spain	-4.0000000,40.0000000
Sweden	15.0000000,62.0000000
Switzerland	8.0000000,47.0000000
Taiwan	121.0000000,23.5000000
Thailand	100.0000000,15.0000000
Tunisia	9.0000000,34.0000000
Turkey	35.0000000,39.0000000
United Kingdom	-.1300000,51.5000000
United States	-97.0000000,38.0000000

Following is the original Master File, COMMA1.

```
FILENAME=COMMA1 , SUFFIX=FIX, IOTYPE=STREAM
DATASET=apname/countryl.ftm, $
```

```

SEGNAME=COU, SEGTYPE=S1, $
  FIELDNAME=COUNTRY, ALIAS=E01, USAGE=A15, ACTUAL=A15, $
  FIELDNAME=LNGLAT, ALIAS=LNGLAT, USAGE=A25, ACTUAL=A25, $

```

Following is the COMMA2 Master File, with the DFIX segment added.

```

FILENAME=COMMA2 , SUFFIX=FIX, IOTYPE=STREAM,
DATASET=appname/countryl.ftm, $
  SEGNAME=COU, SEGTYPE=S1, $
    FIELDNAME=COUNTRY, ALIAS=E01, USAGE=A15, ACTUAL=A15, $
    FIELDNAME=LNGLAT, ALIAS=LNGLAT, USAGE=A25, ACTUAL=A25, $
  SEGNAME=COMMA2, SEGTYPE=S0, SEGSUF=DFIX, PARENT=COU, POSITION=LNGLAT, $
    FIELD=COORD, ALIAS = XY, USAGE=A25, ACTUAL=A25, $

```

Following is the COMMA2 Access File.

```

SEGNAME=COMMA2, RDELIMITER=',', HEADER=NO, PRESERVESPACE=NO, $

```

The following request uses the COMMA2 Master File to print the values.

```

TABLE FILE COMMA2
PRINT COORD
BY COUNTRY
END

```

On the output, the LNGLAT field has been treated as two separate records. The partial output follows:

COUNTRY	COORD
-----	-----
Argentina	-64.0000000
	-34.0000000
Australia	133.0000000
	-27.0000000
Austria	13.3333000
	47.3333000
Belgium	4.0000000
	50.8333000
Brazil	-55.0000000
	-10.0000000
Canada	-95.0000000
	60.0000000
Chile	-71.0000000

	-30.0000000
China	105.0000000
	35.0000000
Colombia	-72.0000000

Creating a Multiple-Root Cluster Master File

A cluster Master File is a Master File in which each segment is added to the cluster by reference using a CRFILE attribute that points to the base synonym. Child segments are joined to their parents using a JOIN WHERE attribute. A cluster Master File can have multiple root segments. In this case, the root segments are usually fact tables and the child segments are usually dimension tables, as found in a star schema. This type of structure is called a multi-fact cluster.

Each fact table that is a root of the cluster must have a PARENT=. attribute in the Master File to identify it as a root segment.

A dimension table can be a child of multiple fact tables (called a shared dimension) or be a child of a single fact table (called a non-shared dimension). Each shared dimension has multiple PARENT attributes in the Master File.

The following image shows a simple multi-fact structure.

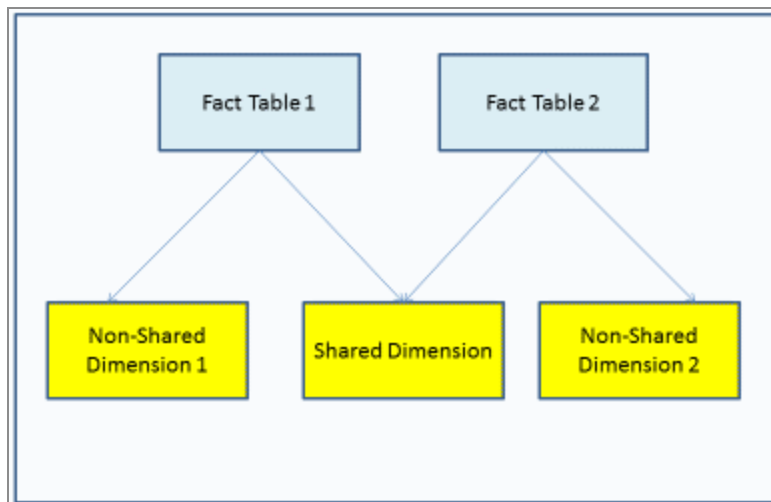

For information about reporting against a multi-fact Master File, see the *FOCUS® Creating Reports* manual.

Define a Multi-Fact Cluster

Each root segment description must have a PARENT=. attribute in the Master File. The following syntax describes the attributes necessary to define a root segment in a multi-fact cluster. All other segment attributes are also supported.

```
SEGMENT=rsegname, PARENT=., CRFILE=[rapp/]rfilename,
    CRINCLUDE=ALL,$
```

where:

SEGMENT=rsegname

Is the name of the root segment.

PARENT=.

Defines this segment as a root segment in a multi-fact cluster.

CRFILE=[rapp/]rfilename

Is the optional application path and the name of the Master File where the root fact table is described.

CRINCLUDE=ALL

Makes all fields from the fact table accessible using this cluster Master File. If you omit this attribute, you must list the fields from the fact table that you want to be accessible using this Master File.

The following is an example of a root segment description from the WFLITE Master File that is in the wfretail application.

```
SEGMENT=WF_RETAIL_SALES, PARENT=., CRFILE=wfretail/facts/wf_retail_
sales,
    CRINCLUDE=ALL, DESCRIPTION='Sales Fact', $
```

Each shared dimension must have multiple PARENT attributes in the Master File and a JOIN WHERE attribute for each parent. The following syntax describes the attributes necessary to define a shared dimension in a multi-fact cluster Master File.

```
SEGMENT=dsegname, CRFILE=[dapp/]dfilename,
    [CRSEGMENT=crsegname,] CRINCLUDE=ALL,$
```

```

PARENT=parent1, SEGTYPE=KU, CRJOINTYPE=jointype1,
  JOIN_WHERE=expression1;, $
PARENT=parent2, SEGTYPE=KU, JOIN_TYPE=jointype2,
  JOIN_WHERE=expression2;,
. . . $

```

where:

SEGMENT=dsegname

Is the name of the shared dimension segment.

CRFILE=[dapp/]dfilename

Is the optional application path and the name of the Master File where the dimension table is described.

CRSEGMENT=crsegname

Is the name of the segment to which to join in the dimension Master File. This is optional if the dimension Master File has a single segment.

CRINCLUDE=ALL

Makes all fields from the dimension table accessible using this cluster Master File. If you omit this attribute, you must list the fields from the fact table that you want to be accessible using this Master File.

PARENT=parent1 PARENT=parent2 ...

Are the names of the parent segments of the shared dimension.

CRJOINTYPE=jointype1

Is a supported join type for the join between the shared dimension and the first parent segment. Valid values are INNER, LEFT-OUTER, RIGHT-OUTER, FULL-OUTER. The type of join specified must be supported by the relational engine in which the tables are defined.

JOIN_TYPE=jointype2

Is a supported join type a join between the shared dimension and a subsequent parent segment. Valid values are INNER, LEFT-OUTER, RIGHT-OUTER, FULL-OUTER. The type of join specified must be supported by the relational engine in which the tables are defined.

JOIN_WHERE=expression1; JOIN_WHERE=expression2;

Are the join expressions for the joins between each parent segment and the shared dimension.

For a synonym that describes a star schema, each expression usually describes an equality condition (using the EQ operator) and a 1-to-many relationship.

The following is an example of a shared dimension segment definition from the WFLITE Master File, where the synonym is defined in the wfretail application.

```
SEGMENT=WF_RETAIL_CUSTOMER, CRFILE=wfretail/dimensions/wf_retail_
customer,
    CRINCLUDE=ALL, DESCRIPTION='Customer Dimension', $
PARENT=WF_RETAIL_SALES, SEGTYPE=KU, CRJOINTYPE=LEFT_OUTER,
JOIN_WHERE=WF_RETAIL_SALES.ID_CUSTOMER EQ
WF_RETAIL_CUSTOMER.ID_CUSTOMER;; $
PARENT=WF_RETAIL_SHIPMENTS, SEGTYPE=KU, JOIN_TYPE=LEFT_OUTER,
JOIN_WHERE=WF_RETAIL_SHIPMENTS.ID_CUSTOMER EQ
WF_RETAIL_CUSTOMER.ID_CUSTOMER;; $
```

The following is an example of a non-shared dimension segment definition from the WFLITE Master File, where the synonym is defined in in the wfretail application.

```
SEGMENT=WF_RETAIL_TIME_DELIVERED, SEGTYPE=KU, PARENT=WF_RETAIL_
SHIPMENTS,
    CRFILE=wfretail/dimensions/wf_retail_time_lite,
    CRSEGMENT=WF_RETAIL_TIME_LITE,
    CRINCLUDE=ALL, CRJOINTYPE=LEFT_OUTER,
    JOIN_WHERE=ID_TIME_DELIVERED EQ WF_RETAIL_TIME_DELIVERED.ID_TIME;;
    DESCRIPTION='Shipping Time Delivered Dimension',
    SEG_TITLE_PREFIX='Delivery,', $
```

Creating a Business View of a Master File

A Business View (BV) of a Master File groups related items together to reflect an application business logic rather than the physical position of items in the data source. By separating the information model of the data from its physical storage mechanisms, the Business View gives developers and users access to the information they need in order to solve a business problem without involving them in the intricacies of the database design.

Grouping Business Logic In a Business View

A Business View is a limited set of fields accessible by users and stored as part of a real Master File. Defining a Business View provides users with a limited view of the data, simplifies application maintenance, and provides additional security.

A Business View is organized into virtual segments called folders, which are defined below all of the real and cross-reference segments in the Master File. Each folder can contain a group of fields and can contain other folders. A folder can also be empty. The fields in a folder can come from different segments in the Master File. If the fields do not lie along a single path in the Master File and your request includes fields from separate paths, warning messages may be generated when you run the request.

Hierarchies of folders can be defined by specifying the PARENT attribute in the child folder declarations.

When a Business View is used in a request, all of the actual field and security information comes from the original segments. If the field is from a cross-referenced segment in the Master File, all of the cross-reference segment and key information remains in the original Master File containing that segment.

A Business View can include real fields, calculated values (COMPUTES), virtual fields (DEFINES), and filters from the original Master File.

Business Views are most useful as views of relational and FOCUS data sources.

The field and segment names in a Business View can be the same as the names in the original segments, or you can assign new names in the Business View. When a new field name is assigned in a Business View, the ALIAS value must be the original field name.

Define a Folder

```
FOLDER = folder_name, [PARENT=parent_folder_name
  [,DESCRIPTION="default_desc"
  [, DESC_ln="desc_for_ln" ...]] $
  [FIELD = bv_field_name, [ALIAS=real_field_name] ,
  [BELONGS_TO_SEGMENT= real_segment_name] ,
  [, TITLE = "default_title"
  [, TITLE_ln="title_for_ln" ...]]]
  [, DESC="default_desc"
  [, DESC_ln="desc_for_ln" ...], $]]
  FIELD= bv_field_name[, ALIAS = real_field_name],
  BELONGS_TO_SEGMENT = real_segment_name
  [,TITLE = default_title]
  [,TITLE_ln = title_for_ln]
  [,DESCRIPTION = default_description ]
  [,DESCRIPTION_ln = desc_for_ln] ,,$
```

where:

folder_name

Is the name of a virtual segment in the view. A folder is allowed to be empty.

parent_folder_name

Is the name of the parent of the virtual segment.

bv_field_name

Is the field name you assign. It can be the same as the real field name or a different field name. If it is different, the real field is identified by the ALIAS attribute.

real_field_name

Is the name of the field in the original Master File. This field can be a real field, a virtual field, or a calculated value. If *bv_field_name* matches *real_field_name*, the ALIAS attribute can be omitted. If no ALIAS is specified, the Business View field name must match the field name in the original Master File.

real_segment_name

Is the name of the segment in which the field resides in the original Master File. If the real field name is unique in the original Master File, the BELONGS_TO_SEGMENT attribute can be omitted. If BELONGS_TO_SEGMENT is missing and the field name is not

unique in the original Master File, the first field with a matching field name in the original Master File is used.

default_title

Is the column title to use when the LANG parameter is set to the default language for FOCUS, or another language is set but the Master File has no corresponding TITLE_*ln* attribute for that field. This title is also used if the *ln* value is invalid.

default_desc

Is descriptive text to use when the LANG parameter is set to the default language for FOCUS, or another language is set but the Master File has no corresponding DESC_*ln* attribute for that field. This description is also used if the *ln* value is invalid. This description displays in the front-end user interface.

ln

Specifies the language for which the title or description applies. Valid values for *ln* are the two-letter ISO 639 language code abbreviations.

title_for_ln

Is the title to use when the LANG parameter is set to a non-default language for FOCUS, and the Master File has a corresponding TITLE_*ln* attribute, where *ln* is the two-digit code for the language specified by the LANG parameter.

desc_for_ln

Is the description to use when the LANG parameter is set to a non-default language for FOCUS, and the Master File has a corresponding DESC_*ln* attribute, where *ln* is the two-digit code for the language specified by the LANG parameter.

Languages and Language Codes

Language Name	Two-Letter Language Code	Three-Letter Language Abbreviation
Arabic	ar	ARB

Language Name	Two-Letter Language Code	Three-Letter Language Abbreviation
Baltic	lt	BAL
Chinese - Simplified GB	zh	PRC
Chinese - Traditional Big-5	tw	ROC
Czech	cs	CZE
Danish	da	DAN
Dutch	nl	DUT
English - American	en	AME or ENG
English - UK	uk	UKE
Finnish	fi	FIN
French - Canadian	fc	FRE
French - Standard	fr	FRE
German - Austrian	at	GER
German - Standard	de	GER
Greek	el	GRE
Hebrew	iw	HEW
Italian	it	ITA
Japanese - Shift-JIS (cp942) on ASCII cp939 on EBCDIC	ja	JPN

Language Name	Two-Letter Language Code	Three-Letter Language Abbreviation
Japanese - EUC (cp10942) on ASCII (UNIX)	je	JPE
Korean	ko	KOR
Norwegian	no	NOR
Polish	pl	POL
Portuguese - Brazilian	br	POR
Portuguese - Portugal	pt	POR
Russian	ru	RUS
Spanish	es	SPA
Swedish	sv	SWE
Thai	th	THA
Turkish	tr	TUR

Usage Notes for Business Views

- The detailed information about fields, such as USAGE and ACTUAL formats or indexes remain in the original segment.
- To include fields from more than one Master File in the Business View, the segments must all be included in the Master File that contains the Business View, either as a cross-reference or a cluster join.

- DBA attributes that are defined in the Master File that contains the Business View will apply to the Business View. To apply DBA attributes from cross-reference segments, the SET DBASOURCE=ALL command must be in effect.
- Business Views do not support data source maintenance commands such as Maintain, MODIFY, SCAN, FSCAN, or COMBINE,.
- When a Master File contains more than one field with the same name, as can occur when files are joined, the BELONGS_TO_SEGMENT attribute identifies which instance of the field name is being referenced in the Business View.
- Folders can be empty.
- The USE command supports Business Views.
- Master File profiles (MFD_PROFILE attribute) are run for each Master File accessed.
- SORTOBJ and STYLEOBJ declarations are not supported in the original master
- You can issue an SQL SELECT command against a Business View. However, a Direct SQL Passthru request is not supported against a Business View.
- Business Views can be encrypted and decrypted with the ENCRYPT and DECRYPT commands.
- Business Views support alternate file views and fully qualified field names.
- The SEG. operator against a Business View folder displays all of the fields in that folder, not all of the fields in the real segment.
- Requests against a Business View cannot reference real fields or segments that are not in the Business View.
- All HOLD formats are supported against a Business View.
- All adapters for non-FOCUS data sources support retrieval requests against a Business View.

Creating a Business View

The following Business View of the EMPLOYEE data source consists of three folders:

- The first folder contains the employee ID, name current salary, and current job code fields from the EMPLOYEE Master File.

- The second folder contains the salary and increase history fields from the PAYINFO segment of the original Master File.
- The third folder contains the job code and job description fields from the JOBSEG segment, which is a cross-referenced segment.

Note that a field named JOBCODE exists in folders 2 and 3. The BELONGS_TO_SEGMENT attribute distinguishes between the JOBCODE field from the PAYINFO segment and the JOBCODE field from the JOBSEG segment in the EMPLOYEE Master File. Also note that the fields defined with different names than in the real segments have ALIAS values that specify the field names in the real segments.

```

FILENAME=EMPLOYEE, SUFFIX=FOC, REMARKS='Legacy Metadata Sample:
employee', $
SEGNAME=EMPINFO,  SEGTYPE=S1
  FIELDNAME=EMP_ID,      ALIAS=EID,      FORMAT=A9,      $
  FIELDNAME=LAST_NAME,  ALIAS=LN,      FORMAT=A15,     $
  FIELDNAME=FIRST_NAME, ALIAS=FN,      FORMAT=A10,     $
  FIELDNAME=HIRE_DATE,  ALIAS=HDT,     FORMAT=I6YMD,   $
  FIELDNAME=DEPARTMENT, ALIAS=DPT,     FORMAT=A10,     $
  FIELDNAME=CURR_SAL,   ALIAS=CSAL,    FORMAT=D12.2M,  $
  FIELDNAME=CURR_JOBCODE, ALIAS=CJC,     FORMAT=A3,      $
  FIELDNAME=ED_HRS,     ALIAS=OJT,     FORMAT=F6.2,    $
SEGNAME=FUNDTRAN, SEGTYPE=U,  PARENT=EMPINFO
  FIELDNAME=BANK_NAME,  ALIAS=BN,      FORMAT=A20,     $
  FIELDNAME=BANK_CODE,  ALIAS=BC,      FORMAT=I6S,     $
  FIELDNAME=BANK_ACCT,  ALIAS=BA,      FORMAT=I9S,     $
  FIELDNAME=EFFECT_DATE, ALIAS=EDATE,   FORMAT=I6YMD,   $
SEGNAME=PAYINFO,  SEGTYPE=SH1, PARENT=EMPINFO
  FIELDNAME=DAT_INC,    ALIAS=DI,      FORMAT=I6YMD,   $
  FIELDNAME=PCT_INC,    ALIAS=PI,      FORMAT=F6.2,    $
  FIELDNAME=SALARY,     ALIAS=SAL,     FORMAT=D12.2M,  $
  FIELDNAME=JOBCODE,    ALIAS=JBC,     FORMAT=A3,      $
SEGNAME=ADDRESS,  SEGTYPE=S1,  PARENT=EMPINFO
  FIELDNAME=TYPE,       ALIAS=AT,      FORMAT=A4,      $
  FIELDNAME=ADDRESS_LN1, ALIAS=LN1,     FORMAT=A20,     $
  FIELDNAME=ADDRESS_LN2, ALIAS=LN2,     FORMAT=A20,     $
  FIELDNAME=ADDRESS_LN3, ALIAS=LN3,     FORMAT=A20,     $
  FIELDNAME=ACCTNUMBER,  ALIAS=ANO,     FORMAT=I9L,     $
SEGNAME=SALINFO,  SEGTYPE=SH1, PARENT=EMPINFO
  FIELDNAME=PAY_DATE,   ALIAS=PD,      FORMAT=I6YMD,   $
  FIELDNAME=GROSS,      ALIAS=MO_PAY,  FORMAT=D12.2M,  $
SEGNAME=DEDUCT,   SEGTYPE=S1,  PARENT=SALINFO
  FIELDNAME=DED_CODE,   ALIAS=DC,      FORMAT=A4,      $
  FIELDNAME=DED_AMT,    ALIAS=DA,      FORMAT=D12.2M,  $
SEGNAME=JOBSEG,   SEGTYPE=KU,  PARENT=PAYINFO, CRFILE=JOBFILE,

```

```

CRKEY=JOBCODE,$
SEGNAME=SECSEG, SEGTYPE=KLU,PARENT=JOBSEG, CRFILE=JOBFILE,$
SEGNAME=SKILLSEG,SEGTYPE=KL, PARENT=JOBSEG, CRFILE=JOBFILE,$
SEGNAME=ATTNDSEG,SEGTYPE=KM, PARENT=EMPINFO, CRFILE=EDUCFILE,CRKEY=EMP_
ID,$
SEGNAME=COURSEG, SEGTYPE=KLU,PARENT=ATTNDSEG,CRFILE=EDUCFILE,$

```

```

FOLDER=FOLDER1, $
FIELDNAME=EMPID, ALIAS=EMP_ID,
BELONGS_TO_SEGMENT=EMPINFO, $
FIELDNAME=LASTNAME, ALIAS=LAST_NAME,
BELONGS_TO_SEGMENT=EMPINFO, $
FIELDNAME=FIRSTNAME,
ALIAS=FIRST_NAME,
BELONGS_TO_SEGMENT=EMPINFO, $
FIELDNAME=DEPARTMENT,
BELONGS_TO_SEGMENT=EMPINFO, $
FIELDNAME=CURRSAL, ALIAS=CURR_SAL,
BELONGS_TO_SEGMENT=EMPINFO, $
FIELDNAME=CURR_JOBCODE,
BELONGS_TO_SEGMENT=EMPINFO, $

```

```

FOLDER=FOLDER3, PARENT=FOLDER1, $
FIELDNAME=DAT_INC,
BELONGS_TO_SEGMENT=PAYINFO, $
FIELDNAME=PCT_INC,
BELONGS_TO_SEGMENT=PAYINFO, $
FIELDNAME=SALARY,
BELONGS_TO_SEGMENT=PAYINFO, $
FIELDNAME=JOBCODE,
BELONGS_TO_SEGMENT=PAYINFO, $

```

```

FOLDER=FOLDER2, PARENT=FOLDER1, $
FIELDNAME=JOBCODE,
BELONGS_TO_SEGMENT=JOBSEG, $
FIELDNAME=JOB_DESC,
BELONGS_TO_SEGMENT=JOBSEG, $

```

One of the folders contains the JOBCODE field from the JOBSEG segment. The JOBSEG segment in EMPLOYEE is a cross-referenced segment that points to the JOBFIL Master File. The JOBFIL Master File follows:

```

FILENAME=JOBFILE ,SUFFIX=FOC, $
SEGNAME=JOBSEG ,SEGTYPE=S1

```

```

FIELD=JOBCODE      ,ALIAS=JC              ,USAGE=A3          ,INDEX=I,$
FIELD=JOB_DESC    ,ALIAS=JD              ,USAGE=A25         ,,$
SEGNAME=SKILLSEG ,SEGTYPE=S1          ,PARENT=JOBSEG
FIELD=SKILLS      ,ALIAS=                ,USAGE=A4          ,,$
FIELD=SKILL_DESC ,ALIAS=SD            ,USAGE=A30         ,,$
SEGNAME=SECSEG   ,SEGTYPE=U          ,PARENT=JOBSEG
FIELD=SEC_CLEAR  ,ALIAS=SC            ,USAGE=A6          ,,$

```

The following procedure references the Business View:

```

TABLE FILE EMPLOYEE
PRINT FOLDER3.JOBCODE JOB_DESC
BY LASTNAME BY FIRSTNAME
BY HIGHEST 1 DAT_INC  NOPRINT
END

```

The output is:

LAST_NAME	FIRST_NAME	JOBCODE	JOB_DESC
BANNING	JOHN	A17	DEPARTMENT MANAGER
BLACKWOOD	ROSEMARIE	B04	SYSTEMS ANALYST
CROSS	BARBARA	A17	DEPARTMENT MANAGER
GREENSPAN	MARY	A07	SECRETARY
IRVING	JOAN	A15	ASSIST.MANAGER
JONES	DIANE	B03	PROGRAMMER ANALYST
MCCOY	JOHN	B02	PROGRAMMER
MCKNIGHT	ROGER	B02	PROGRAMMER
ROMANS	ANTHONY	B04	SYSTEMS ANALYST
SMITH	MARY	B14	FILE QUALITY
	RICHARD	A01	PRODUCTION CLERK
STEVENS	ALFRED	A07	SECRETARY

Next, add a filter to the EMPLOYEE Master File, and include it in FOLDER1 of the Business View.

In the EMPLOYEE Master File:

```

FILTER DFILTER WITH EMPINFO.EMP_ID=DEPARTMENT EQ 'MIS'; $

```

In the Business View:

```

FIELDNAME=DFILTER, ALIAS=DFILTER, BELONGS_TO_SEGMENT=EMPINFO, $

```

The following request implements the filter:

```
TABLE FILE EMPLOYEE
PRINT FOLDER3.JOB_CODE JOB_DESC
BY LASTNAME BY FIRSTNAME
BY HIGHEST 1 DAT_INC NOPRINT
WHERE DFILTER
END
```

The output is:

LAST_NAME	FIRST_NAME	JOB_CODE	JOB_DESC
-----	-----	-----	-----
BLACKWOOD	ROSEMARIE	B04	SYSTEMS ANALYST
CROSS	BARBARA	A17	DEPARTMENT MANAGER
GREENSPAN	MARY	A07	SECRETARY
JONES	DIANE	B03	PROGRAMMER ANALYST
MCCOY	JOHN	B02	PROGRAMMER
SMITH	MARY	B14	FILE QUALITY

Business View DV Roles

A traditional Business View offered users a customized logical view of a data source by grouping related items into folders that reflect business logic for an application, rather than the physical position of items in the data source. However, the fields in these folders did not have any indication of their roles in a request.

A traditional Dimension View, on the other hand, categorized fields on the basis of their roles in a request. Measures were placed in measure groups, hierarchies were organized within dimensions, levels were organized within hierarchies, and attributes were organized within levels. Dimension Views, however, offered no ability to create a custom logical view of the data source.

DV Roles in a Business View enable you to group fields into folders and, for each field, assign a role that indicates its role in a request. The syntax is clear and simple, and it gives you total flexibility in creating folders anywhere in the structure, and in reusing fields in multiple folders.

Assigning DV Roles

In Business Views, you define folders, which function as segments to provide a view of the synonym and to define the accessible fields and their relationships. Folder relationships are the same as segment relationships, with parent folders, child folders, and sibling folders.

While you have total flexibility defining a structure using any fields from your data source, when you issue a report request against the synonym, the retrieval path for the data must conform to any constraints imposed by your DBMS entity diagrams and by the rules of FOCUS retrieval.

You can explicitly assign a DV role to a folder or field, or have it automatically inherit its role from its parent. If you explicitly assign a DV role, that role moves with the object if you move it to another location within the BV structure. If you do not explicitly assign a DV role, the role changes as you move the object to a new parent, except if you move it onto a field with the Drill Level role. If moved onto a Drill Level field, the moved field inherits the Drill Level role.

The following DV roles can be assigned.

- **Dimension.**

A folder can be assigned the role Dimension.

A field can be assigned the role Dimension (Standalone) or Dimension (Drill Level). When it is assigned the role Dimension (Drill Level), it will become part of a hierarchy where the levels depend on the order of the fields in the folder.

For a folder assigned the DV role Dimension or a field assigned the DV role Dimension (Standalone), the following attribute is added to the folder or field declaration in the synonym.

```
DV_ROLE=DIMENSION
```

For a field assigned the DV role Dimension (Drill Level), the following attribute is added to the field declaration in the synonym.

```
DV_ROLE=LEVEL
```

A folder can contain only one drill level hierarchy. However, you can use the same fields in multiple hierarchies by placing each hierarchy in a separate folder. A folder with a drill level hierarchy is not limited to just the hierarchy. It can contain other

fields with different DV_ROLES.

- **Measure.** A folder or field can be assigned the role Measure.

For a folder or field assigned the DV role Measure, the following attribute is added to the folder or field declaration in the synonym.

```
DV_ROLE=MEASURE
```

- **Attribute.** A folder or field can be assigned the role Attribute.

For a folder or field assigned the DV role Attribute, the following attribute is added to the folder or field declaration in the synonym.

```
DV_ROLE=ATTRIBUTE
```

- **Folder.** A folder is a virtual segment in a BV. It can be assigned the roles Dimension, Measure, or Attribute.

i Note: When a folder is inserted as a child of a field, the attribute PARENT_FIELD describes this relationship. By default, such a folder and its fields will be assumed to have the Attribute role.

- **None.** If no role is assigned, the field or folder will inherit its role from its parent. If a role has been assigned, you can remove it by selecting the option to inherit its role from its parent.

Sample Dimension Folder Declaration

The DV_ROLE for the PRODUCT folder is DIMENSION.

```
FOLDER=PRODUCT, PARENT=FOLDER1,
DV_ROLE=DIMENSION,
DESCRIPTION='Product and Vendor', $
```

Checking and Changing a Master File: CHECK

Use the CHECK command to validate your Master Files. You must always do this after writing the Master File. If you do not issue the CHECK command, your Master File may not be reloaded into memory if a parsed copy already exists.

Checking a Data Source Description

The CHECK output highlights any errors in your Master File and allows you to correct each before reading the data source. After making any necessary corrections, use CHECK again to confirm that the Master File is valid.

Check a Data Source Description

```
CHECK FILE filename[.field] [PICTURE [RETRIEVE]] [DUPLICATE]
[HOLD [AS name] [ALL]]
```

where:

filename

Is the name under which you created the Master File.

.field

Is used for an alternate view of the Master File.

PICTURE

Is an option that displays a diagram showing the complete data source structure. The keyword PICTURE can be abbreviated to PICT. This option is explained in [PICTURE Option](#).

RETRIEVE

Alters the picture to reflect the order in which segments are retrieved when TABLE or TABLEF commands are issued. Note that unique segments are viewed as logical extensions of the parent segment. The keyword RETRIEVE can be abbreviated to RETR.

DUPLICATE

Lists duplicate field names for the specified data source. The keyword DUPLICATE can be abbreviated to DUPL.

HOLD

Generates a temporary HOLD file and HOLD Master File containing information about fields in the data source. You can use this HOLD file to write reports. The AS option specifies a field name for your data sources. The option is described and illustrated in [HOLD Option](#).

name

Is a name for the HOLD file and HOLD Master File.

ALL

Adds the values of FDEFCENT and FYRTHRESH at the file level and the values of DEFCENT and YRTHRESH at the field level to the HOLD file.

CHECK Command Display

If your Master File contains syntactical errors, the CHECK command displays appropriate messages.

CHECK FILE Command Output

If the data source description has no syntactical errors, the CHECK command displays the following message

```
NUMBER OF ERRORS=      0
NUMBER OF SEGMENTS=   n  ( REAL=      n  VIRTUAL=      n  )
NUMBER OF FIELDS=     n  INDEXES=     n  FILES=         n
```

```
NUMBER OF DEFINES=      n
TOTAL LENGTH OF ALL FIELDS=  n
```

where:

NUMBER OF ERRORS

Indicates the number of syntactical errors in the Master File.

NUMBER OF SEGMENTS

Is the number of segments in the Master File, including cross-referenced segments.

REAL

Is the number of segments that are not cross-referenced. These segments have types Sn, SHn, U, or blank.

VIRTUAL

Is the number of segments that are cross-referenced. These segments have types KU, KLU, KM, KL, DKU, or DKM.

NUMBER OF FIELDS

Is the number of fields described in the Master File.

INDEXES

Is the number of indexed fields. These fields have the attribute FIELDTYPE=I or INDEX=I in the Master File.

FILES

Is the number of data sources containing the fields.

NUMBER OF DEFINES

Is the number of virtual fields in the Master File. This message appears only if virtual fields are defined.

TOTAL LENGTH

Is the total length of all fields as defined in the Master File by either the FORMAT attribute (if the data source is a FOCUS data source) or the ACTUAL attribute (if the data source is a non-FOCUS data source).

Using the CHECK File Command

Entering the following command

```
CHECK FILE EMPLOYEE
```

produces the following information:

```
NUMBER OF ERRORS=      0
NUMBER OF SEGMENTS=  11      ( REAL=   6 VIRTUAL=   5 )
NUMBER OF FIELDS=   34      INDEXES=   0 FILES=    3
TOTAL LENGTH OF ALL FIELDS = 365
```

When using FOCUS online, this message displays on the terminal even if the PRINT parameter is set to OFFLINE.

Determining Common Errors

- If the data source is a non-FOCUS data source, check the TOTAL LENGTH OF ALL FIELDS to verify the accuracy of the field lengths specified. One of the most common causes of errors in generating reports from non-FOCUS data sources is incorrectly specified field lengths. The total length of all fields should be equal to the logical record length of the non-FOCUS data source.

In general, if the total length of all fields is not equal to the logical record length of the non-FOCUS data source, the length of at least one field is specified incorrectly. Your external data may not be read correctly if you do not correct the error.

- If the following warning message is generated, duplicate fields (those having the same field names and aliases) are not allowed in the same segment. The second occurrence is never accessed.

```
(FOC1829) WARNING. FIELDNAME IS NOT UNIQUE WITHIN A SEGMENT:
fieldname
```

When the CHECK command is issued for a data source with more than one field of the same name in the same segment, a FOC1829 message is generated along with a warning such as the following indicating that the duplicate fields cannot be accessed:

```
(FOC1829) WARNING. FIELDNAME IS NOT UNIQUE WITHIN A SEGMENT: BB
WARNING: FOLLOWING FIELDS CANNOT BE ACCESSED
BB IN SEGMENT SEGA          (VS SEGB
```

When the DUPLICATE option is added, the output contains a warning message that indicates where the first duplicate field resides:

```
WARNING: FOLLOWING FIELDS APPEAR MORE THAN ONCE
AA IN SEGMENT SEGB          (VS SEGA)
```

PICTURE Option

The PICTURE option displays a diagram of the structure defined by the Master File. Each segment is represented by a box. There are four types of boxes, which indicate whether a segment (including the root segment) is non-unique or unique and whether it is real or cross-referenced. The four types of boxes are

Real segments

Non-unique segment:	Unique segment:
<pre>segname numsegtype ***** *field1 **I *field2 ** *field3 ** *field4 ** * ** ***** *****</pre>	<pre> segname num U ***** *field1 *I *field2 * *field3 * *field4 * * * *****</pre>

Cross-referenced segments

Non-unique segment:	Unique segment
<pre>segname</pre>	

<pre> num KM (or KLM) :field1 ::K :field2 :: :field3 :: :field4 :: : :: :.....: :.....: crfile </pre>	<pre> segname num KU (or KLU) :field1 :K :field2 : :field3 : :field4 : : : :.....: crfile </pre>
---	--

where:

num

Is the number assigned to the segment in the structure.

segname

Is the name of the segment.

segtype

Is the segment type for a real, non-unique segment: Sn, SHn, or N (for blank segtypes).

field1...

Are the names of fields in the segment. Field names greater than 12 characters are truncated to 12 characters in CHECK FILE PICTURE operations, with the last character appearing as a ' >', indicating that more characters exist than can be shown.

I

Indicates an indexed field.

K

Indicates the key field in the cross-referenced segment.

crfile

Is the name of the cross-referenced data source if the segment is cross-referenced.

The diagram also shows the relationship between segments (see the following example). Parent segments are shown above children segments connected by straight lines.

Using the CHECK FILE PICTURE Option

The following diagram shows the structure of the JOB data source joined to the SALARY data source:

```

JOIN EMP_ID IN JOB TO EMP_ID IN SALARY
>
CHECK FILE JOB PICTURE
  NUMBER OF ERRORS=      0
  NUMBER OF SEGMENTS=  2  ( REAL=    1  VIRTUAL=    1 )
  NUMBER OF FIELDS=    7  INDEXES=    0  FILES=    2
  TOTAL LENGTH OF ALL FIELDS=  86
SECTION 01
          STRUCTURE OF FOCUS      FILE JOB      ON 01/31/03 AT 12.33.04

          JOBSEG
01      S1
*****
*EMP_ID      **
*FIRST_NAME  **
*LAST_NAME   **
*JOB_TITLE   **
*            **
*****
          *****
              I
              I
              I
              I  SALSEG
02      I  KU
.....
:EMP_ID      :K
:SALARY      :
:EXEMPTIONS  :
:            :
:            :
:.....:
JOINED  SALARY

```

HOLD Option

The HOLD option generates a temporary HOLD file. HOLD files are explained in the *FOCUS® Creating Reports* manual. This HOLD file contains detailed information regarding file, segment, and field attributes, which you can display in reports using TABLE requests.

Certain fields in this HOLD file are of special interest. Unless otherwise noted, these fields are named the same as attributes in Master Files. Each field stores the values of the similarly named attribute. The fields can be grouped into file attributes, segment attributes, and field attributes.

File Attributes:

FILENAME, SUFFIX, FDEFCENT, FYRTHRESH

Note that the FDEFCENT and FYRTHRESH attributes are included in the HOLD file, if they exist in the original Master File and you specify the ALL option.

Segment Attributes:

SEGNAME, SEGTYPE

Note that this field does not indicate the number of segment key fields. Segment types S1, S2, and so on are shown as type S. The same is true with segment type SHn.

SKEYS

The number of segment key fields. For example, if the segment type is S2, SKEYS has the value 2.

SEGNO

The number assigned to the segment within the structure. This appears in the picture.

LEVEL

The level of the segment within the structure. The root segment is on Level 1, its children are on Level 2, and so on.

PARENT, CRKEY, FIELDNAME

Field Attributes:

ALIAS, FORMAT, ACTUAL

Note that if you include the FORMAT field in the TABLE request, do not use the full field name FORMAT. Rather, you should use the alias USAGE or a unique truncation of the FORMAT field name (the shortest unique truncation is FO).

DEFCENT, YRTHRESH

Note that these attributes are included in the HOLD file, if they exist in the original Master File and you specify the ALL option.

Using the CHECK FILE HOLD Option

This sample procedure creates a HOLD file describing the EMPLOYEE data source. It then writes a report that displays the names of cross-referenced segments in the EMPLOYEE data source, the segment types, and the attributes of the fields: field names, aliases, and formats.

```
CHECK FILE EMPLOYEE HOLD
TABLE FILE HOLD
HEADING
"FIELDNAMES, ALIASES, AND FORMATS"
"OF CROSS-REFERENCED FIELDS IN THE EMPLOYEE DATA SOURCE"
" "
PRINT FIELDNAME/A12 ALIAS/A12 USAGE BY SEGNAME BY SEGTYPE
WHERE SEGTYPE CONTAINS 'K'
END
```

The output is:

```
PAGE 1

FIELDNAMES, ALIASES, AND FORMATS
OF CROSS-REFERENCED FIELDS IN THE EMPLOYEE DATA SOURCE
```

SEGNAME	SEGTYPE	FIELDNAME	ALIAS	FORMAT
-----	-----	-----	-----	-----
ATTNDSEG	KM	DATE_ATTEND	DA	I6YMD
		EMP_ID	EID	A9
COURSEG	KLU	COURSE_CODE	CC	A6
		COURSE_NAME	CD	A30
JOBSEG	KU	JOB_CODE	JC	A3
		JOB_DESC	JD	A25
SECSEG	KLU	SEC_CLEAR	SC	A6
SKILLSEG	KL	SKILLS		A4
		SKILL_DESC	SD	A30

Using the CHECK FILE HOLD ALL Option

Assume the EMPLOYEE data source contains the following FILE declaration:

```
FILENAME = EMPLOYEE, SUFFIX = FOC, FDEFCENT = 19, FYRTHRESH = 50
```

The following request:

```
CHECK FILE EMPLOYEE HOLD ALL
TABLE FILE HOLD
PRINT FDEFCENT FYRTHRESH
END
```

produces the following output:

FDEFCENT	FYRTHRESH
-----	-----
19	50

Specifying an Alternate File Name With the HOLD Option

An AS name may be provided for the temporary HOLD file generated by the CHECK command. If a name is not specified, the default name is HOLD and any existing default file will be replaced.

i Note: When the AS option is specified in combination with other CHECK options, the AS holdname specification must appear last.

TITLE, HELPMESSAGE, and TAG Attributes

When using the HOLD option of the CHECK command, the TITLE text is placed in the TITLE field of the FLDATTR segment, the HELPMESSAGE text in the HELPMESSAGE field of the FLDATTR segment, and the TAG names in the TAGNAME field of the SEGATTR segment.

When no JOINS are in effect, or when a JOIN command is issued without a TAG name, the TAGNAME field by default contains the name of the data source specified in the CHECK command. When JOINS are issued in conjunction with the TAG name feature, the TAGNAME field contains the TAG name for the host and cross-referenced data sources.

Virtual Fields in the Master File

With the HOLD option, virtual fields are placed in the segment in which they would be stored if they were real fields in the data source. This is not necessarily the physical location of the field in the Master File, but the lowest segment that must be accessed in order to evaluate the expression defining the field. Fields whose values are not dependent on retrieval default to the top segment. The value of FLDSEG in the FLDATTR segment is zero for these fields. The format of FLDSEG is I2S in the Master File, which causes zero to appear as blank in reports. FLDSEG may be dynamically reformatted in a TABLE request (FLDSEG/I2) to force the display of zero.

After data has been entered into a data source, you can no longer make arbitrary changes to the Master File. Some changes are entirely harmless and can be made at any time. Others are prohibited unless the data is reentered or the data source is rebuilt. A few others can be made if corresponding changes are made in several places.

You can use a system editor or TED to make permitted changes to the Master File. The checking procedure, CHECK, should be used after any change.

Accessing a FOCUS Data Source: USE

The USE command specifies the names and locations of FOCUS data sources for the following conditions:

- Default naming conventions are not used.
- You need to protect data sources from change or concatenate several similar data sources.

i Note:

- For non-default naming conventions, you may be able to use the DATASET attribute in the Master File instead of the USE command. For detailed information, see [Identifying a Data Source](#).
- You can use an Access File instead of a USE command to concatenate FOCUS data sources. When a FOCUS data source is partitioned, an Access File may be required for efficient retrieval. For more information, see [Describing a FOCUS Data Source](#).
- You must issue a USE command in order to work with an external index.

USE Command

When you issue a FOCUS command to access a FOCUS data source, such as TABLE FILE *filename*, FOCUS searches for a Master File with the specified file name, and then searches for a data source allocated to the same ddname.

For example, the command TABLE FILE EMPLOYEE uses the data source allocated to ddname EMPLOYEE.

If the FOCUS data source has a file ID different from these defaults, you must issue the USE command to identify the data source, with its file specifications, and associate it with a specific Master File.

The USE command specifies the names and locations of FOCUS data sources for the following conditions:

- Default naming conventions are not used.
- To protect data sources from change or concatenate several similar data sources.

When you identify FOCUS data sources with the USE command, a USE directory is created, which is a list of data source definitions. When a USE directory is in effect, FOCUS will locate data sources using the information in the directory, instead of searching for the data source using default names. A USE directory enables you to access up to 1022 data sources. The USE directory applies only to FOCUS data sources.

Issue a USE Command

```
USE action  
fileid [READ|NEW] [AS mastername]
```

or

```
fileid AS mastername ON server READ
```

or

```
fileid LOCAL
```

or

```
fileid ON server  
.  
.  
.  
ind {WITH|INDEX} mastername  
END
```

where:

action

Is one of the following:

ADD appends one or more new file IDs to the present directory. If you issue the USE command without the ADD parameter, the list of data sources you specify replaces the existing USE directory.

CLEAR erases the USE directory. The keyword END is not required with this option. Any other options specified will be ignored.

REPLACE replaces an existing file ID in the USE directory. This option enables you to change the file specification for the file ID and the options following the file ID.

fileid

Is a valid ddname allocated to the data set containing your FOCUS data source.

READ

Restricts data sources to read-only access.

NEW

Indicates that the data source has yet to be created.

AS mastername

Specifies the name of the Master File to be associated with the file ID.

ON server

Specifies the communications data set of the FOCUS Database Server.

LOCAL

This option requires a previous directory entry for the file ID with the ON *server* option.

This option accesses an SU data source using the Multi-Threaded SU Reporting Facility. Before using this option, you must allocate the SU data source in SHR mode.

ind

Is the ddname of an external index.

WITH|INDEX

Establishes the relationship between an external index and the component data source. INDEX is a synonym for WITH.

The following options after the file ID are valid together:

```
READ and AS  
NEW and AS  
AS and ON and READ
```

Any other combination of options after the file ID is not valid.

Specify Multiple Data Sources

You can specify several data sources in one USE command, each with different parameters. For example:

```
USE  
fileid1 ON MULTID  
fileid2 AS PRODUCTS  
fileid3 READ AS ACCOUNTS  
END
```

Erase USE Specifications

To erase the USE specifications, enter the following command:

```
USE CLEAR
```

Specifying a Non-Default File ID

If the FOCUS data source has a file ID other than the default, issue the USE command to identify the data source, with its file specifications, and associate it with a specific Master File.

Specify a Non-Default File ID

```
fileid AS mastername  
END
```

where:

fileid

Is any valid file specification for the specific operating system.

mastername

Is name of the Master File name that will be associated with the file ID.

Specifying Different File Names

To read the data source with the name EMP026 described by the Master File EMPLOYEE, enter this USE command:

```
USE  
EMP026 AS EMPLOYEE  
END
```

After entering the USE command, you can read the EMP026 data source by entering the command TABLE FILE EMPLOYEE.

Identifying New Data Sources to FOCUS

The parameter NEW in the USE command identifies data sources that do not exist yet. When you identify a new data source, you can accept the default file specification conventions or specify different ones.

You must allocate the data source, with the z/OS command ALLOCATE or the FOCUS command DYNAM, before you issue the USE command.

Identify New Data Sources to FOCUS

```
USE  
fileid NEW  
END  
CREATE file mastername
```

where:

fileid

Is any valid ddname. The file ID will be assigned to the data source later in the session when the actual create happens.

The FOCUS data source will be created as a temporary file unless you previously allocated a permanent data source to the ddname in the USE command.

mastername

Is the name of the Master File associated with the data source.

If you omit the NEW parameter, a message is returned stating that the data source cannot be found, and the USE command is not executed.

Identifying a New Data Source

To create the data source WAGES using the WAGES Master File, enter the following:

```
USE  
WAGES NEW  
END  
CREATE FILE WAGES
```

Accessing Data Sources in Read-Only Mode

You can protect data sources from changes by issuing USE commands with the READ parameter. Protected data sources can be read by various FOCUS tools and commands such as MODIFY and SCAN, but cannot be changed.

Access a Data Source in Read-Only Mode

```
USE  
fileid READ  
END
```

where:

fileid

Is any valid file specification for the operating system.

Accessing a Data Source in Read-Only Mode

For example, to protect the data source EMPLOYEE, enter:

```
USE  
EMPLOYEE READ  
END
```

Concatenating Data Sources

If several FOCUS data sources are described by the same Master File, you can read all of the data sources in one TABLE or GRAPH request by issuing a USE command that concatenates all of the data sources.

Concatenate Data Sources

```
USE  
fileid1 AS mastername  
fileid2 AS mastername  
.  
.  
fileidn AS mastername
```

```
END
```

where:

fileid1...

Are any valid file specifications, for the operating system, for the data sources being concatenated.

mastername

Is the name of the Master File that describes the data sources.

Concatenating Data Sources to One Master File

For example, to read three FOCUS data sources: EMP024, EMP025, and EMP026, all described by the Master File EMPLOYEE, issue the following USE command:

```
USE  
EMP024 AS EMPLOYEE  
EMP025 AS EMPLOYEE  
EMP026 AS EMPLOYEE  
END
```

You can then read all three data sources with the command TABLE FILE EMPLOYEE.

Concatenating Multiple Master Files

You can concatenate data sources to several Master Files in one USE command. For example, the following USE command concatenates the EMP01 and EMP02 data sources to the Master File EMPLOYEE, and concatenates the SALES01 and SALES02 data sources to the Master File SALES:

```
USE  
EMP01 AS EMPLOYEE  
EMP02 AS EMPLOYEE  
SALES01 AS SALES  
SALES02 AS SALES  
END
```

To read the EMP01 and EMP02 data sources, begin by entering

```
TABLE FILE EMPLOYEE
```

and to read the SALES01 and SALES02 data sources, begin by entering

```
TABLE FILE SALES
```

Concatenating Multiple Data Sources and a Single Cross-Reference Data Source

To read multiple data sources with a cross-reference data source as one data source, specify the host data sources in the USE command and then the cross-reference data source.

For example, the data source EMPLOYEE is made up of two data sources EMP01 and EMP02 that reference a common cross-reference data source EDUCFILE. To read the two data sources together, enter the following USE command:

```
USE  
EMP01 AS EMPLOYEE  
EMP02 AS EMPLOYEE  
EDUCFILE  
END
```

Concatenating Multiple Data Sources and Multiple Cross-Reference Data Sources

If the EMPLOYEE data source consisted of two data sources, EMP01 and EMP02, and each had its own cross-reference data source, ED01 and ED02, you can read all four data sources in one command by entering this USE command where each host data source is followed by its cross-reference.

You cannot specify a concatenated data source as the cross-referenced data source in a JOIN command.

Take an indexed view of a concatenated data source by creating an external index data source and using the TABLE FILE *filename.indexed_fieldname* command. For more information about indexed views, see the instructions for creating an external index data source in the *Maintaining Databases* manual.

```
USE
EMP01 AS EMPLOYEE
ED01 AS EDUCFILE
EMP02 AS EMPLOYEE
ED02 AS EDUCFILE
END
```

Accessing Simultaneous Usage Data Sources

The FOCUS Database Server is a batch job or started task managing all READ/WRITE operations to a FOCUS data source.

Access Simultaneous Usage Data Sources

```
USE
fileid ON server
END
```

where:

fileid

Is the ddname of the FOCUS data source allocated in the batch job or started task.

Accessing an SU Data Source

To use the EMPLOYEE FOCUS data source allocated to the FOCUS Database Server batch job or started task, two things must be done:

1. Allocate a ddname to the communications data set that is allocated in the FOCUS

Database Server batch job or started task pointed to by the ddname FOCUSU.

For example,

```
DYNAM ALLOC FILE MYSERVER DS prefix.FOCUSU.DATA SHR
```

2. Issue the USE command for your data source allocated in the batch job or started task. For example:

```
USE
EMPLOYEE ON MYSERVER
END
```

Multi-Thread Configuration

Performance gains may be achieved by routing read-only requests directly to the data source on disk instead of through the FOCUS Database Server. This is called a multi-thread configuration. It is accomplished with the USE command and the keyword LOCAL.

Read SU Data Sources in a Multi-Thread Configuration

Allocate the FOCUS data source and issue the USE LOCAL syntax:

```
DYNAM ALLOC FILE EMPLOYEE DS prefix.EMPLOYEE.FOCUS SHR
DYNAM ALLOC FILE MYSERVER DS prefix.FOCUSU.DATA SHR
USE
EMPLOYEE ON MYSERVER
EMPLOYEE LOCAL
END
```

For more information about Simultaneous Usage Mode, see your Simultaneous Usage documentation.

i Note:

- On a FOCUS Database Server, 255 data sources can be open at one time with 512 users connected.
- The READ option is available for accessing an SU data source with an alternate Master File (using an AS name). For example:

```
USE EMP01 AS EMPLOYEE ON MULTID READ
```

In an SU environment, the READ option does not provide read-only access. It is required because alternate Master Files are not supported in SU for MODIFY and MAINTAIN.

Displaying the USE Options in Effect

To display USE options in effect, enter the ? USE query in a stored procedure:

```
? USE
```

This query displays a list of data sources you specified with the USE commands, with options currently in effect.

Displaying USE Options

A sample output from the ? USE command is:

```
? USE
DIRECTORIES IN USE ARE:
CAR
EMPLOYEE
JOBFILE
EDUCFILE
```

Providing Data Source Security: DBA

As a Database Administrator, you can use DBA security features to provide security for any FOCUS data source. You can use these security features to limit the number of records or reads a user can request in a report.

You can also create user-written programs to perform program accounting on FOCUS data sources. You can use the Usage Accounting and Security Exit Routine (UACCT) to collect usage statistics and data on attempted access violations.

You can also use DBA security features to provide security for non-FOCUS® data sources. Note that DBA security cannot protect a data source from non-FOCUS access.

i Note: All references to FOCUS data sources also apply to XFOCUS data sources.

Introduction to Data Source Security

The DBA facility provides a number of security options:

- You can limit the user who has access to a given data source using the USER attribute discussed in [Identifying Users With Access Rights: The USER Attribute](#).
- You can restrict a user access right to read, write, or update only using the ACCESS attribute discussed in [Specifying an Access Type: The ACCESS Attribute](#).
- You can restrict a user access to certain fields or segments using the RESTRICT attribute discussed in [Limiting Data Source Access: The RESTRICT Attribute](#).
- You can ensure that only records that pass a validation test are retrieved using the RESTRICT attribute discussed in [Limiting Data Source Access: The RESTRICT Attribute](#).
- You can limit the values a user can read or write to the data source or you can limit which values a user can alter using the RESTRICT attribute discussed in [Limiting Data Source Access: The RESTRICT Attribute](#).
- You can control the source of access restrictions in a multi-file structure using the SET DBASOURCE command discussed in [Controlling the Source of Access Restrictions](#)

[in a Multi-file Structure.](#)

- You can point to passwords and restrictions stored in another Master File with the DBAFILE attribute discussed in [Placing Security Information in a Central Master File](#).
- You can use the FOCUSID exit routine to allow an external security system to set the FOCUS password. For more information, see the *WebFOCUS® Security and Administration* manual. For more information, see the *ibi™ WebFOCUS® Security and Administration* manual.
- You can place security on FOCEXECs, as discussed in [FOCEXEC Security](#).

Program accounting, resource limitation, and the UACCT exit routine are discussed in [Program Accounting/Resource Limitation](#).

Also, whenever a new data source is created, you have to decide whether or not to invoke the FOCUS shadow paging feature, which guarantees the integrity of the data in the data source. The shadow paging feature is discussed in [Absolute File Integrity](#).

Implementing Data Source Security

You provide FOCUS security on a file-by-file basis. Implementing DBA security features is a straightforward process in which you specify:

- The names or passwords of FOCUS users granted access to a data source.
- The type of access the user is granted.
- The segments, fields, or ranges of data values to which the user access is restricted.

The declarations (called security declarations) follow the END command in a Master File and tell FOCUS that security is needed for the data source and what type of security is needed. Each security declaration consists of one or several of the following attributes:

- The DBA attribute gives the name or password of the Database Administrator for the data source. The Database Administrator has unlimited access to the data source and its Master File.
- The USER attribute identifies a user as a legitimate user of the data source. Only users whose name or password is specified in the Master File of a FOCUS data source with security placed on it have access to that data source.
- The ACCESS attribute defines the type of access a given user has. The four types of access available are:

RW, which allows a user to both read and write to a data source.

R, which allows a user only to read data in a data source.

W, which allows a user to only write new segment instances to a data source.

U, which allows a user only to update records in a data source.

- The RESTRICT attribute specifies certain segments or fields to which the user is not granted access. It can also be used to restrict the data values a user can see or perform transactions on.
- The NAME and VALUE attributes are part of the RESTRICT declaration.

Describe your data source security by specifying values for these attributes in a comma-delimited format, just as you specify any other attribute in the Master File.

The word END on a line by itself in the Master File terminates the segment and field attributes and indicates that the access limits follow. If you place the word END in a Master File, it must be followed by at least a DBA attribute.

Implementing Data Source Security in a Master File

The following is a Master File that uses security features:

```

FILENAME = PERS, SUFFIX = FOC,$
SEGMENT = IDSEG, SEGTYPE = S1,$
  FIELD = SSN           ,ALIAS = SSN      ,FORMAT = A9      ,$
  FIELD = FULLNAME     ,ALIAS = FNAME   ,FORMAT = A40    ,$
  FIELD = DIVISION     ,ALIAS = DIV      ,FORMAT = A8     ,$
SEGMENT=COMPSEG, PARENT=IDSEG, SEGTYPE=S1,$
  FIELD = SALARY       ,ALIAS = SAL      ,FORMAT = D8     ,$
  FIELD = DATE         ,ALIAS = DATE    ,FORMAT = YMD    ,$
  FIELD = INCREASE     ,ALIAS = INC     ,FORMAT = D6     ,$
END
DBA=JONES76,$
USER=TOM      ,ACCESS=RW, $
USER=BILL    ,ACCESS=R  ,RESTRICT=SEGMENT ,NAME=COMPSEG    ,$
USER=JOHN    ,ACCESS=R  ,RESTRICT=FIELD   ,NAME=SALARY     ,$
              ,NAME=INCREASE  ,$
USER=LARRY   ,ACCESS=U  ,RESTRICT=FIELD   ,NAME=SALARY     ,$
USER=TONY    ,ACCESS=R  ,RESTRICT=VALUE   ,NAME=IDSEG,
  VALUE=DIVISION EQ 'WEST' ,$
USER=MARY    ,ACCESS=W  ,RESTRICT=VALUE   ,NAME=SALTEST,
  VALUE=INCREASE+SALARY GE SALARY,$

```

```
VALUE=DIV NE ' ' AND DATE GT 0,$ NAME=HISTTEST,
```

Special Considerations for Data Source Security

- When using the JOIN command, it is possible to bypass the DBA information in a data source. This is a security exposure created because in a JOIN structure the DBA information is read from the host Master File. This problem is solved by using the DBAFILE feature discussed in [Placing Security Information in a Central Master File](#). All data sources in the joined structure will get security information as coded in the DBAFILE.
- The DBA section of a Master File cannot have comments within it.

Identifying the DBA: The DBA Attribute

The first security attribute should be a password that identifies the Database Administrator. This password can be up to 64 characters long and is not case-sensitive. It can include special characters. If the DBA password contains blanks, it must be enclosed in single quotation marks. Since nothing else is needed, this line is terminated by the usual delimiter (,\$).

i Note:

- Every data source having access limits must have a DBA.
- Groups of cross-referenced data sources must have the same DBA value.
- Partitioned data sources, which are read together in the USE command, must have the same DBA value.
- The Database Administrator has unlimited access to the data source and all cross-referenced data sources. Therefore, no field, segment, or value restrictions can be specified with the DBA attribute.
- You cannot encrypt and decrypt Master Files or restrict existing data sources without the DBA password.
- You should thoroughly test every security attribute before the data source is used. It is particularly important to test the VALUE limits to make sure they do not contain errors. Value tests are executed as if they were extra screening conditions or VALIDATE statements typed after each request statement. Since users are unaware of the value limits, errors caused by the value limits may confuse them.

Identifying the DBA Using the DBA Attribute

```
DBA=JONES76,$
```

Change a DBA Password

The DBA has the freedom to change any of the security attributes. If you change the DBA password in the Master File for an existing FOCUS data source, you must use the RESTRICT command to store the changed DBA password in each FOCUS data source affected by the change. Unless this is done, FOCUS assumes that the new description is an attempt to bypass the restriction rules. You use the following procedure for each data source affected:

Procedure

1. Edit the Master File, changing the DBA value from old to new.

- Issue the command:

```
SET PASS=old_DBA_password
```

- Issue the command:

```
RESTRICT
mastername
END
```

- Issue the command:

```
SET PASS=new_DBA_password
```

Including the DBA Attribute in a HOLD File

With the SET HOLDSTAT command, you can identify a data source containing DBA information and comments to be automatically included in HOLD and PCHOLD Master Files. For more information about the SET HOLDSTAT command, see the *Developing Applications* manual.

The data source must be a member in the PDS allocated to ddname MASTER or ERRORS. MASTER takes precedence over ERRORS.

The Information Builders-supplied file is named HOLDSTAT; user-specified HOLDSTAT files can have any valid file name.

The HOLDSTAT file must contain a dollar sign (\$) in column 1. The keyword \$BOTTOM in the file indicates there is DBA information to be added.

The following sample HOLDSTAT is included with FOCUS:

```
$=====
$   HOLD file created on &DATE at &TOD by FOCUS &FOCREL   $
$           Database records retrieved= &RECORDS           $
$           Records in the HOLD file = &LINES              $
$=====
```

To include DBA information in HOLD Master Files, use the following syntax at the bottom of the HOLDSTAT file:

```
$BOTTOM
END
DBA=...
```

Note: User-defined variables may not be included in the comments portion of the HOLDSTAT file. Other DBA attributes can be included in the HOLDSTAT file as system variables.

All lines from the HOLDSTAT file that appear prior to \$BOTTOM are placed at the top of the HOLD Master File, before any file and field declarations. All lines that appear after \$BOTTOM are appended to the bottom of the HOLD Master File. Any Dialogue Manager variables are replaced with the actual variable values.

Including a Comment in a HOLD Master File

The following example illustrates the use of HOLDSTAT. The TABLE request is:

```
SET HOLDSTAT = ON
TABLE FILE EMPLOYEE
PRINT LAST_NAME FIRST_NAME SALARY
BY EID
ON TABLE HOLD
END
```

It produces the HOLD Master File:

```
$=====
$   HOLD file created on 2003/05/20 at 17.58.10 by FOCUS 7.3   $
$           Database records retrieved=           19           $
$           Records in the HOLD file =           19           $
$=====
FILE = HOLD      ,SUFFIX = FIX
SEGNAME = HOLD, SEGTYPE = S01
FIELDNAME = EMP_ID           ,E01           ,A9           ,A12           , $
FIELDNAME = LAST_NAME       ,E02           ,A15           ,A16           , $
FIELDNAME = FIRST_NAME      ,E03           ,A10           ,A12           , $
FIELDNAME = SALARY          ,E04           ,D12.2M       ,D08           , $
```

Including DBA Attributes in a HOLD Master File

The next example illustrates the use of a user-specified file containing DBA information. The HOLD Master File that is generated contains DBA information from the file name specified in the SET HOLDSTAT command. The HOLDDBA Master File is:

```

$=====
$   HOLD file created on &DATE at &TOD by FOCUS &FOCREL   $
$           Database records retrieved= &RECORDS           $
$           Records in the HOLD file = &LINES              $
$=====
$BOTTOM
END
DBA=MARY,$

```

The following TABLE request uses the HOLDDBA Master File:

```

SET HOLDSTAT = HOLDDBA
TABLE FILE EMPLOYEE
PRINT LAST_NAME FIRST_NAME SALARY
BY EID
ON TABLE HOLD
END

```

The HOLD Master File that results is:

```

$=====
$   HOLD file created on 2003/05/20 at 17.58.10 by FOCUS 7.3   $
$           Database records retrieved=           19           $
$           Records in the HOLD file =           19           $
$=====
FILE = HOLD ,SUFFIX = FIX
SEGNAME = HOLD, SEGTYPE = S01
FIELDNAME = EMP_ID           ,E01           ,A9           ,A12           , $
FIELDNAME = LAST_NAME       ,E02           ,A15           ,A16           , $
FIELDNAME = FIRST_NAME      ,E03           ,A10           ,A12           , $
FIELDNAME = SALARY          ,E04           ,D12.2M       ,D08           , $
END
DBA=MARY,$

```

Identifying Users With Access Rights: The USER Attribute

The USER attribute is a password that identifies the users who have legitimate access to the data source. A USER attribute cannot be specified alone. It must be followed by at least one ACCESS restriction (discussed in [Specifying an Access Type: The ACCESS Attribute](#)) to specify what sort of ACCESS the user is granted.

Before using a secured data source, a user must enter the password using the SET PASS or SET USER command. If that password is not included in the Master File, the user is denied access to the data source. When the user does not have a password, or has one that is inadequate for the type of access requested, the following message appears:

```
(FOC047) THE USER DOES NOT HAVE SUFFICIENT ACCESS RIGHTS TO THE FILE:  
filename
```

Set the USER Attribute

Any user whose name or password is not declared in the Master File is denied access to that data source. The syntax of the USER attribute is

```
USER = name
```

where:

name

Is a password of up to 64 characters for the user. The password can include special characters and is not case-sensitive. If the password contains blanks, it must be enclosed in single quotation marks.

You can specify a blank password (default value if not previously changed). Such a password does not require the user to issue a SET PASS= command. A blank password may still have access limits and is convenient when a number of users have the same access rights.

Setting the USER Attribute

```
USER=TOM,...
```

An example of setting a user password to blank, and access to read only follows:

```
USER= , ACCESS=R,$
```

Non-Overridable User Passwords (SET PERMPASS)

The PERMPASS parameter establishes a user password that remains in effect throughout a session or connection. You can issue this setting in any supported profile but it is most useful when established for an individual user by setting it in a user profile. It cannot be set in an ON TABLE phrase. It is recommended that it not be set in FOC Parm or FOC Prof because it would then apply to all users. In a FOCUS session, SET PERMPASS can be issued in PROFILE, a FOCEXEC, or at the command prompt.

All security rules established in the DBA sections of existing Master Files are respected when PERMPASS is in effect. The user cannot issue the SET PASS or SET USER command to change to a user password with different security rules. Any attempt to do so generates the following message:

```
(FOC32409) A permanent PASS is in effect. Your PASS will not be honored.  
VALUE WAS NOT CHANGED
```

i Note: Only one permanent password can be established in a session. Once it is set, it cannot be changed within the session.

Set a Non-Overridable User Password

```
SET PERMPASS=userpass
```

where:

userpass

Is the user password used for all access to data sources with DBA security rules established in their associated Master Files.

Setting a Non-Overridable User Password

Consider the MOVIES Master File with the following DBA rules in effect:

```
DBA=USER1,$
USER = USERR, ACCESS = R , $
USER = USERU, ACCESS = U , $
USER = USERW, ACCESS = W , $
USER = USERRW, ACCESS = RW, $
```

The following FOCEXEC sets a permanent password:

```
SET PERMPASS = USERU
TABLE FILE MOVIES
PRINT TITLE BY DIRECTOR
END
```

The user has ACCESS=U and, therefore, is not allowed to issue a table request against the file:

```
(FOC047) THE USER DOES NOT HAVE SUFFICIENT ACCESS RIGHTS TO THE FILE:
CAR
BYPASSING TO END OF COMMAND
```

The permanent password cannot be changed:

```
SET PERMPASS = USERRW
```

```
(FOC32409) A permanent PASS is in effect. Your PASS will not be honored.
VALUE WAS NOT CHANGED
```

The user password cannot be changed:

```
SET PASS = USERRW
```

```
(FOC32409) A permanent PASS is in effect. Your PASS will not be honored.  
VALUE WAS NOT CHANGED
```

Usage Notes for Non-Overridable User Passwords

- If you use FOCUSID to set passwords externally, these external passwords may be overridable or non-overridable. If they are non-overridable, they take precedence over the PERMPASS setting.
- SET PERMPASS is supported in MSO. The profiles available in order of precedence are:

Member PROFILE in the data set allocated to ddname MSOPROF. This profile is executed for all users.

Members with users' user IDs as names in the data set allocated to ddname MSOPROF. The profile is executed for the user corresponding to the user ID.

Member PROFILE in the data set allocated by a user to ddname FOCEXEC. This profile is executed for that specific user and is a standard FOCUS profile.

Member SHELPROF in the data set allocated to ddname FOCEXEC in the MSO startup JCL. This profile is executed for all users and is a standard FOCUS profile.

Controlling Case Sensitivity of Passwords

When a DBA or user issues the SET USER, SET PERMPASS or SET PASS command, this user ID is validated before they are given access to any data source whose Master File has DBA attributes. The password is also checked when encrypting or decrypting a FOCEXEC.

The SET DBACSENSITIV command determines whether the password is converted to uppercase prior to validation.

Control Password Case Sensitivity

```
SET DBACSENSITIV = {ON|OFF}
```

where:

ON

Does not convert passwords to uppercase. All comparisons between the password set by the user and the password in the Master File or FOCEXEC are case-sensitive.

OFF

Converts passwords to uppercase prior to validation. All comparisons between the password set by the user and the password in the Master File or FOCEXEC are *not* case-sensitive. OFF is the default value.

Controlling Password Case Sensitivity

Consider the following DBA declaration added to the EMPLOYEE Master File:

```
USER = User2, ACCESS = RW,$
```

User2 wants to report from the EMPLOYEE data source and issues the following command:

```
SET USER = USER2
```

With DBACSENSITIV OFF, User2 can run the request even though the case of the password entered does not match the case of the password in the Master File.

With DBACSENSITIV ON, User2 gets the following message:

```
(FOC047) THE USER DOES NOT HAVE SUFFICIENT ACCESS RIGHTS TO THE FILE:
```

With DBACSENSITIV ON, the user must issue the following command:

```
SET USER = User2
```

i Note: In FOCUS for Mainframe, all user input is transmitted in uppercase. Therefore, a mixed case password cannot be issued at the command line. It must be set in a FOCEXEC or profile.

Establishing User Identity

A user must enter his or her password before using any FOCUS data source that has security specified for it. A single user may have different passwords in different files. For example, in file ONE, the rights of password BILL apply, but in file TWO, the rights of password LARRY apply. Use the SET PASS command to establish the passwords.

Establish User Identity

```
SET {PASS|USER} = name [[IN {file}|* [NOCLEAR]]], name [IN file] ...]
```

where:

name

Is the user name or password. If a character used in the password has a special meaning in your operating environment (for example, as an escape character), you can issue the SET USER command in a FOCEXEC and execute the FOCEXEC to set the password. If the password contains a blank, you do not have to enclose it in single quotation marks when issuing the SET USER command.

file

Is the name of the Master File to which the password applies.

*

Indicates that the *name* replaces all passwords active in all files.

NOCLEAR

Provides a way to replace all passwords in the list of active passwords while retaining the list.

Establishing User Identity

In the following example, the password TOM is in effect for all data sources that do not have a specific password designated for them:

```
SET PASS=TOM
```

For the next example, in file ONE the password is BILL, and in file TWO the password is LARRY. No other files have passwords set for them:

```
SET PASS=BILL IN ONE, LARRY IN TWO
```

Here, all files have password SALLY except files SIX and SEVEN, which have password DAVE.

```
SET PASS=SALLY, DAVE IN SIX
SET PASS=DAVE IN SEVEN
```

The password is MARY in file FIVE and FRANK in all other files:

```
SET PASS=MARY IN FIVE,FRANK
```

A list of the files for which a user has set specific passwords is maintained. To see the list of files, issue:

```
? PASS
```

When the user sets a password IN * (all files), the list of active passwords collapses to one entry with no associated file name. To retain the file name list, use the NOCLEAR option.

In the next example, the password KEN replaces all passwords active in all files, and the table of active passwords is folded to one entry:

```
SET PASS=KEN IN *
```

In the following, MARY replaces all passwords in the existing table of active passwords (which consists of files NINE and TEN) but FRANK is the password for all other files. The option NOCLEAR provides a shorthand way to replace all passwords in a specific list:

```
SET PASS=BILL IN NINE,TOM IN TEN
SET PASS=MARY IN * NOCLEAR,FRANK
```

i Note: The FIND function does not work with COMBINED data sources secured with different passwords.

Users must issue passwords using the SET PASS command during each session in which they use a secured data source. They may issue passwords at any time before using the data source and can issue a different password afterward to access another data source.

Specifying an Access Type: The ACCESS Attribute

The ACCESS attribute specifies what sort of access a user is granted. Every security declaration, except the DBA declaration, must have a USER attribute and an ACCESS attribute.

The following is a complete security declaration, consisting of a USER attribute and an ACCESS attribute.

```
USER=TOM, ACCESS=RW,$
```

This declaration gives Tom read and write (for adding new segment instances) access to the data source.

You can assign the ACCESS attribute one of four values. These are:

ACCESS=R	Read-only
ACCESS=W	Write only
ACCESS=RW	Read the data source and write new segment instances

ACCESS=U	Update only
----------	-------------

Access levels affect what kind of commands a user can issue. Before you decide what access levels to assign to a user, consider what commands that user will need. If a user does not have sufficient access rights to use a given command, the following message appears:

```
(FOC047) THE USER DOES NOT HAVE SUFFICIENT ACCESS RIGHTS TO THE FILE:
filename
```

ACCESS levels determine what a user can do to the data source. Use the RESTRICT attribute (discussed in [Limiting Data Source Access: The RESTRICT Attribute](#)) to limit the fields, values, or segments to which a user has access. Every USER attribute must be assigned an ACCESS attribute. The RESTRICT attribute is optional. Without it, the user has unlimited access to fields and segments within the data source.

Types of Access

The type of access granting use of various FOCUS commands is shown in the following table. When more than one type of access is shown, any type of access marked will allow the user at least some use of that command. Often, however, the user will be able to use the command in different ways, depending on the type of access granted.

Command	R	W	RW	U	DBA
CHECK	X	X	X	X	X
CREATE			X		X
DECRYPT					X
DEFINE	X		X		X

Command	R	W	RW	U	DBA
ENCRYPT					X
FSCAN		X	X	X	X
HLI			X		X
MAINTAIN		X	X	X	X
MATCH	X		X		X
MODIFY		X	X	X	X
REBUILD			X		X
RESTRICT					X
SCAN			X	X	X
TABLE	X		X		X

CHECK Command

Users without the DBA password or read/write access are allowed limited access to the CHECK command. However, when the HOLD option is specified, the warning ACCESS LIMITED BY PASSWORD is produced, and restricted fields are propagated to the HOLD file depending on the DBA RESTRICT attribute. Refer to [Limiting Data Source Access: The RESTRICT Attribute](#) for more information on the RESTRICT attribute.

RESTRICT Attribute Keywords

The RESTRICT attribute keywords affect the resulting HOLD file created by the CHECK command as follows:

FIELD

Fields named with the NAME parameter are not included in the HOLD file.

SEGMENT

The segments named with the NAME parameter are included, but fields in those segments are not.

SAME

The behavior is the same as for the user named in the NAME parameter.

NOPRINT

Fields named in the NAME or SEGNAME parameter are included since the user can reference these.

VALUE

Fields named in the VALUE parameter are included since the user can reference these.

 **Note:** RESTRICT=PROGRAM has no effect on CHECK FILE HOLD.

If you issue the CHECK command with the PICTURE option, the RESTRICT attribute keywords affect the resulting picture as follows:

FIELD

Fields named with the NAME parameter are not included in the picture.

SEGMENT

The boxes appear for segments named with the NAME parameter, but fields in those segments do not.

SAME

The behavior is the same as for the user named in the NAME parameter.

NOPRINT

This option has no effect on the picture.

VALUE

This option has no effect on the picture.

CREATE Command

Only users with the DBA password or read/write (RW) access rights can issue a CREATE command.

DECRYPT Command

Only users with the DBA password can issue a DECRYPT command.

Any attempt to decrypt a Master File that contains DBA when MASTER=OLD generates the following message:

```
(FOC209) THE DATA VALUE EXCEEDS ITS LENGTH SPECIFICATION
```

DEFINE Command

As with all reporting commands, a user need only have an access of R (read only) to use the DEFINE command. An access of R permits the user to read records from the data source and prepare reports from them. The only users who cannot use the DEFINE command are those whose access is W (write only) or U (update only).

ENCRYPT Command

Only users with the DBA password can use the ENCRYPT command.

Host Language Interface (HLI)

In order to have use of the Host Language Interface, a user must have read/write (RW) access. With ACCESS=RW, FIELD and SEGMENT restrictions are active, but VALUE restrictions are not. (See [Limiting Data Source Access: The RESTRICT Attribute](#) for information on these restrictions.)

The password is placed in the File Control Block (FCB), words 19 and 20 (byte 73 to 80).

MODIFY or MAINTAIN Command

Users with ACCESS=W, RW, or U can use the MODIFY or MAINTAIN command. In MODIFY or MAINTAIN, access of U does not allow the user to use the INCLUDE and DELETE actions; only UPDATE operations are permitted. Both ACCESS=RW and ACCESS=W allow full use of all the MODIFY or MAINTAIN features. New instances of data may be added to a data source and old ones deleted; existing values may be updated.

Users with ACCESS=R (read only) can use the MAINTAIN command to retrieve information from the data source. Users with read-only access cannot use the MODIFY command.

REBUILD Command

Only users with the DBA password or read/write (RW) access rights can issue the REBUILD command. This command is only for FOCUS data sources.

RESTRICT Command

Only users with the DBA password may use the RESTRICT command.

FSCAN Facility

Users with ACCESS=RW have unlimited access to the data source, except for any restrictions imposed by the RESTRICT or NAME attributes. Users with ACCESS=U can display the entire data source, except for any restrictions imposed by the RESTRICT or NAME attributes; however, users with ACCESS=U cannot input or delete instances and can update non-key fields only. Users whose access to any portion of the data source is limited to ACCESS=R cannot use FSCAN.

FSCAN honors DBA security restrictions on segments and fields; it prohibits display of those segments and fields from which the user is restricted. FSCAN does not honor DBA field value restrictions and will display all field values regardless of the user.

If the user has no access to a key field in the root segment, that user is blocked from using FSCAN on the data source. If the user has no access to a segment, that segment is not listed on the menu that appears when the user enters the CHILD command.

SCAN Facility

The rules for accessing a data source are the same as for FSCAN except that, in addition, users with ACCESS=W cannot use SCAN.

TABLE or MATCH Command

A user who has access of R or RW may use the TABLE command. Users with access of W or U may not.

Limiting Data Source Access: The RESTRICT Attribute

The ACCESS attribute determines what a user can do with a data source.

The optional RESTRICT attribute further restricts a user access to certain fields, values, or segments.

The RESTRICT=VALUE attribute supports those criteria that are supported by the IF phrase. The RESTRICT=VALUE_WHERE attribute supports all criteria supported in a WHERE phrase, including comparison between fields and use of functions. The WHERE expression will be passed to a configured adapter when possible. For MODIFY, VALUE and VALUE_WHERE are synonymous and are internally converted to VALIDATE commands.

Limit Data Source Access

```
...RESTRICT=level, NAME={name|SYSTEM} [,VALUE=test], $
```

or

```
...RESTRICT=VALUE_WHERE, NAME=name, VALUE=expression; , $
```

where:

level

Can be one of the following:

- **FIELD.** which specifies that the user cannot access the fields named with the NAME parameter.
- **SEGMENT.** which specifies that the user cannot access the segments named with the NAME parameter.
- **PROGRAM.** which specifies that the program named with the NAME parameter will be called whenever the user uses the data source (discussed in [Program Accounting/Resource Limitation](#)).
- **SAME.** which specifies that the user has the same restrictions as the user named in the NAME parameter. No more than four nested SAME users are valid.
- **NOPRINT.** which specifies that the field named in the NAME or SEGMENT parameter can be mentioned in a request statement, but will not display. You can use a VALUE test to limit the restriction to values that satisfy an expression. For example, consider the following RESTRICT=NOPRINT declaration. User MARY can only display the IDs of those employees whose salaries are less than 10000.

```
USER=MARY ,ACCESS=R ,RESTRICT=NOPRINT ,NAME=EMP_ID ,  
VALUE=CURR_SAL LT 10000; , $
```

i Note: A field with RESTRICT=NOPRINT can be referenced in a display command (verb), but not in any type of filtering command, such as IF, WHERE, FIND, LOOKUP, or VALIDATE.

name

Is the name of the field or segment to restrict. When used after NOPRINT, this can only be a field name. NAME=SYSTEM, which can only be used with value tests, restricts every segment in the data source, including descendant segments. Multiple fields or segments can be specified by issuing the RESTRICT attribute several times for one user.

i Note: With value restrictions, NAME=segment restricts the named segment and any segment lower in the hierarchy, whether or not an alternate file view changes the retrieval view. This means that if a parent segment has a value restriction, and a join or alternate file view makes a child segment the new root, the value restriction on the original parent will still apply to the new root.

VALUE

Specifies that the user can have access to only those values that meet the test described in the *test* parameter.

test

Is the value test that the data must meet before the user can have access to it. The test is an expression supported in an IF phrase.

VALUE_WHERE

Specifies that the user can have access to only those values that meet the test described in the *expression* parameter.

expression;

Is the value test that the data must meet before the user can have access to it. The test is an expression supported in a WHERE phrase.

i Note: The semicolon (;) is required.

i Note: For write access, if the *name* is a segment name, a MATCH key ON MATCH/NOMATCH is performed. For any other name, a validate is done without a MATCH.

Restricting Access to Values Using VALUE_WHERE

Add the following DBA declarations to the end of the GGSales Master File. These declarations give USER1 access to the West region and to products that start with the letter C:

```

END
DBA = USERD,$
USER = USER1, ACCESS = R, NAME = SALES01, RESTRICT = VALUE_WHERE,
      VALUE = REGION EQ 'West' AND PRODUCT LIKE 'C%'; , $

```

The following request sets the password to USER1 and sums dollar sales and units by REGION, CATEGORY, and PRODUCT:

```

SET USER = USER1
TABLE FILE GGSALES
SUM DOLLARS UNITS
BY REGION
BY CATEGORY
BY PRODUCT
END

```

The output only displays those regions and products that satisfy the WHERE expression in the Master File:

Region	Category	Product	Dollar Sales	Unit Sales
-----	-----	-----	-----	-----
West	Coffee	Capuccino	915461	72831
	Food	Croissant	2425601	197022
	Gifts	Coffee Grinder	603436	48081
		Coffee Pot	613624	47432

If the RESTRICT=VALUE_WHERE attribute is changed to a RESTRICT=VALUE attribute, the expression is not valid, the following message is generated, and the request does not execute:

```
(FOC002) A WORD IS NOT RECOGNIZED: LIKE 'C%'
```

Limiting Data Source Access

```
USER=BILL ,ACCESS=R ,RESTRICT=SEGMENT ,NAME=COMPSEG,$
```

Restricting Access to a Field or a Segment

The RESTRICT attribute identifies the segments or fields that the user will not be able to access. Anything not named in the RESTRICT attribute will be accessible.

Without the RESTRICT attribute, the user has access to the entire data source. Users may be limited to reading, writing, or updating new records, but every record in the data source is available for the operation.

Restrict Access to a Field or a Segment

```
...RESTRICT=level, NAME=name,$
```

where:

level

Can be one of the following:

FIELD specifies that the user cannot access the fields named with the NAME parameter.

SEGMENT specifies that the user cannot access the segments named with the NAME parameter.

SAME specifies that the user has the same restrictions as the user named in the NAME parameter.

NOPRINT specifies that the field named in the NAME or SEGMENT parameter can be mentioned in a request statement but will not appear. When used after NOPRINT, NAME can only be a field name. A field with RESTRICT=NOPRINT can be referenced in a display command (verb), but not in any type of filtering command, such as IF, WHERE, FIND, LOOKUP, or VALIDATE.

name

Is the name of the field or segment to restrict. When used after NOPRINT, this can only be a field name.

NAME=SYSTEM, which can only be used with value tests, restricts every segment in the data source, including descendant segments. Multiple fields or segments can be specified by issuing the RESTRICT attribute several times for one user.

i Note:

- If a field or segment is mentioned in the NAME attribute, it cannot be retrieved by the user. If such a field or segment is mentioned in a request statement, it will be rejected as beyond the user access rights. With NOPRINT, the field or segment can be mentioned, but the data will not appear. The data will appear as blanks for alphanumeric format or zeros for numeric fields. A field with RESTRICT=NOPRINT can be referenced in a display command (verb), but not in any type of filtering command, such as IF, WHERE, FIND, LOOKUP, or VALIDATE.
- You can restrict multiple fields or segments by providing multiple RESTRICT statements. For example, to restrict Harry from using both field A and segment B, you issue the following access limits:

```
USER=HARRY, ACCESS=R, RESTRICT=FIELD, NAME=A,$
RESTRICT=SEGMENT, NAME=B,$
```

- You can restrict as many segments and fields as you like.
- Using RESTRICT=SAME is a convenient way to reuse a common set of restrictions for more than one password. If you specify RESTRICT=SAME and provide a user name or password as it is specified in the USER attribute for the NAME value, the new user will be subject to the same restrictions as the one named in the NAME attribute. You can then add additional restrictions, as they are needed.

Restricting Access to a Segment

In the following example, Bill has read-only access to everything in the data source except the COMPSEG segment:

```
USER=BILL ,ACCESS=R ,RESTRICT=SEGMENT ,NAME=COMPSEG,$
```

Reusing a Common Set of Access Restrictions

In the following example, both Sally and Harry have the same access privileges as BILL. In addition, Sally is not allowed to read the SALARY field.

```
USER=BILL, ACCESS=R, RESTRICT=VALUE, NAME=IDSEG,  
    VALUE=DIVISION EQ 'WEST', $  
USER=SALLY, ACCESS=R, RESTRICT=SAME, NAME=BILL, $  
    RESTRICT=FIELD, NAME=SALARY, $  
USER=HARRY, ACCESS=R, RESTRICT=SAME, NAME=BILL, $
```

i Note: A restriction on a segment also affects access to its descendants.

Restricting Access to a Value

You can also restrict the values to which a user has access by providing a test condition in your RESTRICT attribute. The user is restricted to using only those values that satisfy the test condition.

You can restrict values in one of two ways: by restricting the values the user can read from the data source, or restricting what the user can write to a data source. These restrictions are two separate functions: one does not imply the other. You use the ACCESS attribute to specify whether the values the user reads or the values the user writes are restricted.

You restrict the values a user can read by setting ACCESS=R and RESTRICT=VALUE. This type of restriction prevents the user from seeing any data values other than those that meet the test condition provided in the RESTRICT attribute. A RESTRICT attribute with ACCESS=R functions as an involuntary IF statement in a report request. Therefore, the syntax for ACCESS=R value restrictions must follow the rules for an IF test in a report request.

i Note: RESTRICT=VALUE is not supported in Maintain Data.

You restrict the values a user can write to a data source by setting ACCESS=W and RESTRICT=VALUE. This type of restriction, which functions as a VALIDATE command in MODIFY, limits the actual values a user can enter. Therefore, the syntax for ACCESS=W value restrictions must follow the rules for a VALIDATE command in MODIFY. You can also use ACCESS=W and RESTRICT=VALUE to limit the data values in the data source for which a user can provide new values. When ACCESS=W, the user will be able to access all data values in the data source. The user will simply be prohibited from entering certain values or new values for certain existing values.

If you want to prevent a user both from entering certain values and from seeing other values, you must issue two RESTRICT attributes: one with ACCESS=W, which limits the values a user can write or alter, and one with ACCESS=R, which limits the values the user can see. ACCESS=RW is meaningless with a RESTRICT=VALUE statement.

i Note: You can display a table listing users and their access privileges with the EX DBATABLE command described in [Displaying the Decision Table](#). For DBATABLE to work properly, you must list all users who have no value restrictions prior to users with value restrictions in the Master File.

Restrict Values a User Can Read

```
...ACCESS=R, RESTRICT=VALUE, NAME=name, VALUE=test,$
```

where:

name

Is the name of the segment which, if referenced, activates the test. To specify all segments in the data source, specify NAME=SYSTEM.

test

Is the test being performed.

Restricting Values a User Can Read

```
USER=TONY, ACCESS=R, RESTRICT=VALUE, NAME=IDSEG,  
VALUE=DIVISION EQ 'WEST', $
```

With this restriction, Tony can only see records from the western division.

You type the test expression after VALUE=. The syntax of the test condition is the same as that used by the TABLE command to screen records, except the word IF does not precede the phrase. (Screening conditions in the TABLE command are discussed in the *FOCUS® Creating Reports* manual.) Should several fields have tests

performed on them, separate VALUE attributes must be provided. Each test must name the segment to which it applies. For example:

```
USER=DICK, ACCESS=R, RESTRICT=VALUE, NAME=IDSEG,
  VALUE=DIVISION EQ 'EAST' OR 'WEST', $
  NAME=IDSEG,
  VALUE=SALARY LE 10000, $
```

If a single test condition exceeds the allowed length of a line, it can be provided in sections. Each section must start with the attribute VALUE= and end with the terminator (,\$). For example:

```
USER=SAM, ACCESS=R, RESTRICT=VALUE, NAME=IDSEG,
  VALUE=DIVISION EQ 'EAST' OR 'WEST', $
  VALUE=OR 'NORTH' OR 'SOUTH', $
```

i Note: The second and subsequent lines of a value restriction must begin with the keyword OR.

You can apply the test conditions to the parent segments of the data segments on which the tests are applicable. Consider the following example:

```
USER=DICK, ACCESS=R, RESTRICT=VALUE, NAME=IDSEG,
  VALUE=DIVISION EQ 'EAST' OR 'WEST', $
  NAME=IDSEG,
  VALUE=SALARY LE 10000, $
```

The field named SALARY is actually part of a segment named COMPSEG. Since the test is specified with NAME=IDSEG, the test is made effective for requests on its parent, IDSEG. In this case, the request PRINT FULLNAME would only print the full names of people who meet this test, that is, whose salary is less than or equal to \$10,000, even though the test is performed on a field that is part of a descendant segment of IDSEG. If, however, the test was made effective on COMPSEG, that is, NAME=COMPSEG, then the full name of everyone in the data source could be retrieved, but with the salary information of only those meeting the test condition.

Restricting Both Read and Write Values

In many cases, it will prove useful to issue both ACCESS=W (for data maintenance) and ACCESS=R (for TABLE) value restrictions for a user. This will both limit the values a user can write to the data source and limit the data values that the user can actually see. You do this by issuing a RESTRICT=VALUE attribute with ACCESS=R to prohibit the user from seeing any values other than those specified in the test condition. You then issue a RESTRICT=VALUE attribute with ACCESS=W that specifies the write restrictions placed on the user. You cannot use ACCESS=RW to do this.

i Note: Write restrictions apply to data maintenance facilities not discussed in this manual. For more information, see the Maintain Data documentation.

Restricting Values a User Can Write

If a user's access rights are either W or U, VALUE tests used with the MODIFY command validate new transactions. The format of the test conditions are those used in the ON MATCH VALIDATE expressions of the MODIFY command, which is discussed in the *Maintaining Databases* manual.

There are two different ways you can restrict the values a user can write to a data source: by restricting the values the user actually is allowed to enter (global validate), or by restricting the values that the user is allowed to change (ON MATCH VALIDATE). You must supply an ACCESS=R restriction to restrict the user from seeing certain data values in the data source.

The simplest type of write restriction is one that prevents the user from entering certain values. Thus, it can be used to enforce editing restrictions. For instance, you use this type of restriction to prevent MODIFY users from entering nonsensical values, such as a salary of \$10. You can also use this type of restriction to restrict the key values a user is allowed to enter.

Restrict Values a User Can Write

```
...ACCESS=W, RESTRICT=VALUE, NAME=name, VALUE=test,$
```

where:

name

Is an arbitrary value used as the validate field name.

test

Is the test being performed.

This type of value test does not require data source values, therefore, you can supply an arbitrary name for the NAME attribute. The expressions are based entirely on transaction values and can be applied to the transaction immediately after reading it.

Restrict Values a User Can Enter in a Segment

If your MODIFY procedure contains MATCH commands, restrict the values a user can enter on a segment level by supplying a segment name for NAME=. This creates a condition similar to an ON MATCH VALIDATE phrase.

```
...ACCESS=W, RESTRICT=VALUE, NAME=name, VALUE=test,$
```

where:

name

Is the name of the segment on which you perform the test.

test

Is the test being performed.

Restricting Values a User Can Write

This example prevents Chuck from entering a salary that is greater than 20,000 or less than 5000. If you use an arbitrary value for NAME=, as shown above, you have created a global restriction similar to the VALIDATE command in MODIFY.

```
(A) USER=CHUCK ,ACCESS=W ,RESTRICT=VALUE ,
    NAME=CHRANGE,
    VALUE=SALARY LT 20000 AND SALARY GT 5000,$
```

```
(B) USER=CHUCK ,ACCESS=W ,RESTRICT=VALUE ,NAME=COMPSEG,
    VALUE=SALARY LT 20000 AND SALARY GT 5000,$
```

The difference between the restriction created in example B and that created by example A has to do with your MODIFY procedures. The conditions in the global restriction created by example A are applied prior to MATCH logic in the MODIFY request. The conditions created by example B are applied after your first ON MATCH condition for COMPSEG right before the action (UPDATE or DELETE) and can reference D. fields.

Restricting Values a User Can Alter

You can also restrict the values a user with ACCESS=W can alter. This type of restriction is dependent on the values that are currently in the data source and prevents the user from changing certain records. The user will be allowed to perform actions only on the records that pass the validation test.

Restrict Values a User Can Alter

The syntax of this type of value test is

```
...ACCESS=W, RESTRICT=VALUE, NAME=name, VALUE=test,$
```

where:

name

Is the name of the segment on which you perform the test.

test

Is the test being performed.

Restricting Values a User Can Alter

```
USER=CHUCK ,ACCESS=U ,RESTRICT=VALUE ,NAME=IDSEG,
VALUE=D.DIVISION EQ 'EAST' , $
```

The prefix D. in front of the field DIVISION signals the use of the data source value of DIVISION. In this case, user Chuck can only change records of people who are in the EAST division. If, instead, you use

```
VALUE=DIVISION EQ 'EAST'
```

for the value test, Chuck will be able to change any record he wants, but the only value acceptable for the DIVISION field is EAST.

The segment name on which the test is to be applied is given as the NAME parameter. If a request statement does not perform any action on this segment, the test itself is not performed. This is true even if you are making changes to a segment that is a child of the segment on which the test is performed.

The VALUE tests are added to any VALIDATE conditions that the MODIFY request contains. Only transactions passing both the VALIDATE and VALUE tests are accepted for processing.

Restricting Both Read and Write Values

In many cases it proves useful to issue both ACCESS=W (for MODIFY) and ACCESS=R (for TABLE) value restrictions for a user. This limits the values a user can write to the data source and limits the data values that the user can actually see. Do this by issuing a RESTRICT=VALUE attribute with ACCESS=R to prohibit the user from seeing any values other than those specified in the test condition. You then issue a RESTRICT=VALUE attribute with ACCESS=W that specifies the write restrictions placed on the user. You cannot use ACCESS=RW to do this.

Restricting Both Read and Write Values for a User

```
USER=TILLY ,ACCESS=R ,RESTRICT=VALUE ,NAME=IDSEG,
VALUE=DIVISION EQ 'NORTH' , $
```

```
ACCESS=W ,RESTRICT=VALUE ,NAME=DIVTEST,  
VALUE=DIVISION EQ 'NORTH', $
```

i Note: HLI requires ACCESS=RW.

Controlling the Source of Access Restrictions in a Multi-file Structure

The DBASOURCE parameter determines which security attributes are used to grant access to multi-file structures. By default, access restrictions are based on the host file in a JOIN structure or the last file in a COMBINE structure. If you set the DBASOURCE parameter to ALL, access restrictions from all files in a JOIN or COMBINE structure will be enforced.

i Note: You can also create and implement a DBAFILE to contain and enforce the access restrictions from all files in a JOIN or COMBINE structure. For information about using a central Master File to contain access restrictions, see [Placing Security Information in a Central Master File](#).

The SET DBASOURCE command can only be issued one time in a session or connection. Any attempt to issue the command additional times will be ignored. If the value is set in a profile such as FOC Parm, no user can change it at any point in the session.

When DBASOURCE=ALL:

- In a TABLE request against a JOIN structure, access to a cross-reference file or segment is allowed only if the user has at least read access to each file in the structure.
- In a MODIFY COMBINE structure, the user must have a minimum of READ access to all files in the structure. The user requires WRITE, UPDATE, or READ/WRITE access to a file in the structure when an INCLUDE, DELETE, or UPDATE request is issued against that file.

When DBASOURCE=HOST:

- In a TABLE request, the user needs read access to the host file in the JOIN structure.

All security limitations come from the host file. Note that you can create and activate a DBAFILE in order to enforce security restrictions from all files in the structure.

- In a MODIFY procedure, the user needs write access to the last file in the COMBINE structure. All security limitations come from the restrictions in the last file in the structure. Note that you can create and activate a DBAFILE in order to enforce security restrictions from all files in the structure.

Control Enforcement of Access Restrictions in a JOIN or COMBINE Structure

```
SET DBASOURCE = {HOST|ALL}
```

where:

HOST

Enforces access restrictions only from the host file in a JOIN structure or the last file in a COMBINE structure unless a DBAFILE is used to enforce access restrictions to other files in the structure. HOST is the default value.

ALL

Requires the user to have read access to every file in a JOIN or COMBINE structure. The user needs W, U, or RW access to a file in a COMBINE structure when an INCLUDE, UPDATE, or DELETE command is issued against that file.

Usage Notes for SET DBASOURCE

- All files in the JOIN or COMBINE structure must have the same DBA password. If the DBA attributes are not the same, there will be no way to access the structure.
- If the SET DBASOURCE command is issued more than once in a session, the following message displays and the value is not changed:

```
(FOC32575) DBASOURCE CANNOT BE RESET
```

VALUE WAS NOT CHANGED

Controlling Access Restrictions in a JOIN

The following request joins the TRAINING data source to the EMPDATA and COURSE data sources and then issues a request against the joined structure:

```
JOIN CLEAR *
JOIN COURSECODE IN TRAINING TO COURSECODE IN COURSE AS J1
JOIN PIN IN TRAINING TO PIN IN EMPDATA AS J2
TABLE FILE TRAINING
PRINT COURSECODE AS 'CODE' CTITLE
    LOCATION AS 'LOC'
BY LASTNAME
WHERE COURSECODE NE ' '
WHERE LOCATION EQ 'CA' OR LOCATION LIKE 'N%'
END
```

When the Master Files do not have DBA attributes, the output is:

LASTNAME	CODE	CTITLE	LOC
-----	----	-----	---
ADAMS	EDP750	STRATEGIC MARKETING PLANNING	NJ
CASTALANETTA	EDP130	STRUCTURED SYS ANALYSIS WKSHP	NY
	AMA130	HOW TO WRITE USERS MANUAL	CA
CHISOLM	EDP690	APPLIED METHODS IN MKTG RESEARCH	NJ
FERNSTEIN	MC90	MANAGING DISTRIBUTOR SALE NETWORK	NY
GORDON	SFC280	FUND OF ACCTG FOR SECRETARIES	NY
LASTRA	MC90	MANAGING DISTRIBUTOR SALE NETWORK	NY
MARTIN	EDP130	STRUCTURED SYS ANALYSIS WKSHP	CA
MEDINA	EDP690	APPLIED METHODS IN MKTG RESEARCH	NJ
OLSON	PU168	FUNDAMNETALS OF MKTG COMMUNICATIONS	NY
RUSSO	PU168	FUNDAMNETALS OF MKTG COMMUNICATIONS	NY
SO	BIT420	EXECUTIVE COMMUNICATION	CA
WANG	PU440	GAINING COMPETITIVE ADVANTAGE	NY
WHITE	BIT420	EXECUTIVE COMMUNICATION	CA

Now, add the following DBA attributes to the bottom of the TRAINING Master File:

```
END
DBA = DBA1,$
USER = TUSER, ACCESS =R,$
```

Running the same request produces the following message:

```
(FOC047) THE USER DOES NOT HAVE SUFFICIENT ACCESS RIGHTS TO THE FILE:
TRAINING
BYPASSING TO END OF COMMAND
```

Now, issue the following SET PASS command:

```
SET PASS = TUSER
```

Add the following DBA attributes to the bottom of the COURSE Master File:

```
END
DBA = DBA1,$
USER = CUSER, ACCESS = R,$
```

Add the following DBA attributes to the bottom of the EMPDATA Master File:

```
END
DBA = DBA1,$
USER = EUSER, ACCESS = R,$
```

Note that the DBA attribute has the same value in all of the Master Files.

Now, run the request again. There will be no security violation, and the report output will be generated. Since the DBASOURCE parameter is set to HOST (the default), you can run the request using a password that is valid only in the host file.

Now, set the DBASOURCE parameter to ALL:

```
SET DBASOURCE = ALL
SET PASS = TUSER
```

Running the request produces the following message because TUSER is not a valid user for the COURSE data source:

```
(FOC052) THE USER DOES NOT HAVE ACCESS TO THE FIELD: CTITLE
```

Now, issue the following SET PASS command that sets a valid password for each file in the structure:

```
SET PASS = TUSER IN TRAINING, CUSER IN COURSE, EUSER IN EMPDATA
```

You can now run the request and generate the report output.

Once the SET DBASOURCE command has been issued, its value cannot be changed. The following SET command attempts to change the value to HOST, but the query command output shows that it was not changed:

```
> > set dbasource = host  
(FOC32575) DBASOURCE CANNOT BE RESET  
VALUE WAS NOT CHANGED
```

Adding DBA Restrictions to the Join Condition

When DBA restrictions are applied to a request on a multi-segment structure, by default, the restrictions are added as WHERE conditions in the report request. When the DBAJJOIN parameter is set ON, DBA restrictions are treated as internal to the file or segment for which they are specified, and are added to the join syntax.

This difference is important when the file or segment being restricted has a parent in the structure and the join is an outer or unique join.

When restrictions are treated as report filters, lower-level segment instances that do not satisfy them are omitted from the report output, along with their host segments. Since host segments are omitted, the output does not reflect a true outer or unique join.

When the restrictions are treated as join conditions, lower-level values from segment instances that do not satisfy them are displayed as missing values, and the report output displays all host rows.

For more information, see the *FOCUS® Creating Reports* manual.

Placing Security Information in a Central Master File

The DBAFILE attribute enables you to place all passwords and restrictions for multiple Master Files in one central file. Each individual Master File points to this central control file. Groups of Master Files with the same DBA password may share a common DBAFILE which itself has the same DBA password.

There are several benefits to this technique, including:

- Passwords only have to be stored once when they are applicable to a group of data sources, simplifying password administration.
- Data sources with different user passwords can be JOINed or COMBINEd. In addition, individual DBA information remains in effect for each data source in a JOIN or COMBINE.

The central DBAFILE is a standard Master File. Other Master Files can use the password and security restrictions listed in the central file by specifying its file name with the DBAFILE attribute.

i Note:

- All Master Files that specify the same DBAFILE have the same DBA password.
- The central DBAFILE, like any Master File, must contain at least one segment declaration and one field declaration before the END statement that signifies the presence of DBA information. Even if a required attribute is not assigned a specific value, it must be represented by a comma. The DBA password in the DBAFILE is the same as the password in all the Master Files that refer to it. This prevents individuals from substituting their own security. All Master Files should be encrypted.
- The DBAFILE may contain a list of passwords and restrictions following the DBA password. These passwords apply to all data sources that reference this DBAFILE. In the example in [Placing Security Attributes in a Central Master File](#), PASS=BILL, with ACCESS=R (read only), applies to all data sources that contain the attribute DBAFILE=FOUR.
- After the common passwords, the DBAFILE may specify data source-specific passwords and additions to general passwords. You implement this feature by including FILENAME attributes in the DBA section of the DBAFILE (for example, FILENAME=TWO). See [File Naming Requirements for DBAFILE](#) for additional information about the FILENAME attribute.
- Data source-specific restrictions override general restrictions for the specified data source. In the case of a conflict, passwords in the FILENAME section take precedence. For example, a DBAFILE might contain ACCESS=RW in the common section, but specify ACCESS=R for the same password by including a FILENAME section for a particular data source.
- Value restrictions accumulate. All value restrictions must be satisfied before retrieval. In the preceding example, note the two occurrences of PASS=JOE. JOE is a common password for all data sources, but in FILENAME=THREE it carries an extra restriction, RESTRICT=..., which applies only to data source THREE.

Place Security Attributes in a Central Master File

```
END  
DBA=dbaname, DBAFILE=filename , $
```

where:

dbaname

Is the same as the dbaname in the central file.

filename

Is the name of the central file.

You can specify passwords and restrictions in a DBAFILE that apply to every Master File that points to that DBAFILE. You can also include passwords and restrictions for specific Master Files by including FILENAME attributes in the DBAFILE.

Placing Security Attributes in a Central Master File

The following example shows a group of Master Files that share a common DBAFILE named FOUR:

```
ONE MASTER  
FILENAME=ONE  
.  
.  
END  
DBA=ABC, DBAFILE=FOUR, $
```

```
TWO MASTER  
FILENAME=TWO  
.  
.  
END  
DBA=ABC, DBAFILE=FOUR, $
```

```

THREE MASTER
FILENAME=THREE
.
.
END
DBA=ABC,
DBAFILE=FOUR,$

```

```

FOUR MASTER
FILENAME=FOUR,$
SEGNAME=mmmmm,$
FIELDNAME=fffff,$
END
DBA=ABC,$
    PASS=BILL,ACCESS=R,$
    PASS=JOE,ACCESS=R,$
FILENAME=TWO,$
    PASS=HARRY,ACCESS=RW,$
FILENAME=THREE,$
    PASS=JOE,ACCESS=R,RESTRICT=...,$
    PASS=TOM,ACCESS=R,$

```

Using DBAFILE With a Join Structure

The following request joins the TRAINING data source to the EMPDATA and COURSE data sources, and then issues a request against the joined structure:

```

JOIN CLEAR *
JOIN COURSECODE IN TRAINING TO COURSECODE IN COURSE AS J1
JOIN PIN IN TRAINING TO PIN IN EMPDATA AS J2
TABLE FILE TRAINING
PRINT COURSECODE AS 'CODE' CTITLE
    LOCATION AS 'LOC'
BY LASTNAME
WHERE COURSECODE NE ' '
WHERE LOCATION EQ 'CA' OR LOCATION LIKE 'N%'
END

```

When the Master Files do not have DBA attributes, the output is:

LASTNAME	CODE	CTITLE	LOC
-----	----	-----	---
ADAMS	EDP750	STRATEGIC MARKETING PLANNING	NJ
CASTALANETTA	EDP130	STRUCTURED SYS ANALYSIS WKSHP	NY
	AMA130	HOW TO WRITE USERS MANUAL	CA
CHISOLM	EDP690	APPLIED METHODS IN MKTG RESEARCH	NJ
FERNSTEIN	MC90	MANAGING DISTRIBUTOR SALE NETWORK	NY
GORDON	SFC280	FUND OF ACCTG FOR SECRETARIES	NY
LAISTRA	MC90	MANAGING DISTRIBUTOR SALE NETWORK	NY
MARTIN	EDP130	STRUCTURED SYS ANALYSIS WKSHP	CA
MEDINA	EDP690	APPLIED METHODS IN MKTG RESEARCH	NJ
OLSON	PU168	FUNDAMNETALS OF MKTG COMMUNICATIONS	NY
RUSSO	PU168	FUNDAMNETALS OF MKTG COMMUNICATIONS	NY
SO	BIT420	EXECUTIVE COMMUNICATION	CA
WANG	PU440	GAINING COMPETITIVE ADVANTAGE	NY
WHITE	BIT420	EXECUTIVE COMMUNICATION	CA

The EMPDATA Master File will be the central DBAFILE for the request. Add the following DBA attributes to the bottom of the EMPDATA Master File:

```
END
DBA=DBA1,$
USER = EUSER, ACCESS = R,$
FILENAME = COURSE
USER = CUSER2, ACCESS=RW,$
```

With these DBA attributes, user EUSER will have read access to all files that use EMPDATA as their DBAFILE. User CUSER2 will have read/write access to the COURSE data source.

Add the following security attributes to the bottom of the COURSE Master File. These attributes make the EMPDATA Master File the central file that contains the security attributes to use for access to the COURSE data source and it sets the DBA attribute to the same value as the DBA attribute in the EMPDATA Master File:

```
END
DBA = DBA1, DBAFILE=EMPDATA,$
```

Add the following security attributes to the bottom of the TRAINING Master File. These attributes make the EMPDATA Master File the central file that contains the security attributes to use for access to the TRAINING data source and it sets the DBA attribute to the same value as the DBA attribute in the EMPDATA Master File:

```
END  
DBA = DBA1, DBAFILE=EMPDATA,$
```

Now, in order to run a request against the JOIN structure, there must be a current user password with read access in effect for each file in the JOIN. Issue the following SET PASS command and run the request:

```
SET PASS = EUSER
```

or

```
SET PASS = EUSER IN *
```

The request runs and produces output because EUSER is a valid user in each of the files in the join.

Since the EMPDATA Master File identifies CUSER2 as a valid user for the COURSE Master File, you can also run the request with the following SET PASS command:

```
SET USER = EUSER IN EMPDATA, EUSER IN TRAINING, CUSER2 IN COURSE
```

Issuing a SET PASS command that does not specify a valid password for each file in the JOIN structure produces one of the following messages, and the request does not run:

```
(FOC052) THE USER DOES NOT HAVE ACCESS TO THE FIELD: fieldname
```

```
(FOC047) THE USER DOES NOT HAVE SUFFICIENT ACCESS RIGHTS TO THE FILE:  
filename
```

File Naming Requirements for DBAFILE

When a DBAFILE includes a FILENAME attribute for a specific Master File, the FILENAME attribute in the referencing Master File must be the same as the FILENAME attribute in the DBA section of the DBAFILE. This prevents users from renaming a Master File to a name unknown by the DBAFILE.

DBAFILE Naming Conventions

```

ONE MASTER
FILENAME=XONE
.
.
.
END
DBA=ABC, DBAFILE=FOUR,$

FOUR MASTER
FILENAME=XFOUR
.
.
.
END
DBA=ABC,$
.
.
.
FILENAME=XONE,$
.
.
.

```

ONE MASTER is referred to in requests as TABLE FILE ONE. However, both ONE MASTER and the DBA section of the DBAFILE, FOUR MASTER, specify FILENAME=XONE.

For security reasons, the FILENAME attribute in the Master File containing the DBAFILE information should *not* be the same as the name of that Master File. Note that in Master File FOUR, the FILENAME attribute specifies the name XFOUR.

Connection to an Existing DBA System With DBAFILE

If there is no mention of the new attribute, DBAFILE, there will be no change in the characteristics of an existing system. In the current system, when a series of data sources is JOINed, the first data source in the list is the controlling data source. Its passwords are the only ones examined. For a COMBINE, only the last data source passwords take effect. All data sources must have the same DBA password.

In the new system, the DBA sections of all data sources in a JOIN or COMBINE are examined. If DBAFILE is included in a Master File, then its passwords and restrictions are read. To make the DBA section of a data source active in a JOIN list or COMBINE, specify DBAFILE for that data source.

After you start to use the new system, convert all of your Master Files. For Database Administrators who want to convert existing systems but do not want a separate physical DBAFILE, the DBAFILE attribute can specify the data source itself.

Connecting to an Existing DBA System With DBAFILE

```
FILENAME=SEVEN,
  SEGNAME=..
  FIELDNAME=...
  .
  .
  .
END
DBA=ABC,DBAFILE=SEVEN,$      (OR DBAFILE= , $)
PASS=...
PASS=...
```

Combining Applications With DBAFILE

Since each data source now contributes its own restrictions, you can JOIN and COMBINE data sources that come from different applications and have different user passwords. The only requirement is a valid password for each data source. You can therefore grant access rights for one application to an application under the control of a different DBA by assigning a password in your system.

You can assign screening conditions to a data source that are automatically applied to any report request that accesses the data source. See the *FOCUS® Creating Reports ibi™ FOCUS® Creating Reports* manual for details.

Summary of Security Attributes

The following is a list of all the security attributes used in FOCUS:

Attribute	Alias	Maximum Length	Meaning
DBA	DBA	8	Value assigned is the code name of the Database Administrator (DBA) who has unrestricted access to the data source.
USER	PASS	8	Values are arbitrary code names, identifying users for whom security restrictions will be in force.
ACCESS	ACCESS	8	Levels of access for this user. Values are: R - read-only W - write new segments only RW - read and write U - update values only
RESTRICT	RESTRICT	8	Types of restrictions to be imposed for this access level. Values are: SEGMENT FIELD VALUE SAME PROGRAM NOPRINT
NAME	NAME	66	Name of segment or field restricted or program to be called.

Attribute	Alias	Maximum Length	Meaning
VALUE	VALUE	No Limit	Test expression which must be true when RESTRICT=VALUE is the type of limit.
DBAFILE	DBAFILE	8	Names the Master File containing passwords and restrictions to use.

Hiding Restriction Rules: The ENCRYPT Command

Since the restriction information for a FOCUS data source is stored in its Master File, you can encrypt the Master File in order to prevent users from examining the restriction rules. Only the Database Administrator can encrypt a description. You must set `PASS=DBAname` before you issue the ENCRYPT command. The syntax of the ENCRYPT command varies from operating system to operating system. See the *Overview and Operating Environments* manual for information on your operating system.

i Note: The first line of a Master File that is going to be encrypted cannot be longer than 68 characters. If it is longer than 68 characters, you must break it up onto multiple lines.

Hide Restriction Rules: ENCRYPT Command

```
ENCRYPT FILE filename
```

where:

filename

Is the name of the file to be encrypted.

Encrypting and Decrypting a Master File

The following is an example of the complete procedure:

```
SET PASS=JONES76
ENCRYPT FILE PERS
```

The process can be reversed in order to change the restrictions. The command to restore the description to a readable form is DECRYPT.

The DBA password must be issued with the SET command before the file can be decrypted. For example:

```
SET PASS=JONES76
DECRYPT FILE PERS
```

Encrypting Data

You may also use the ENCRYPT parameter within the Master File to encrypt some or all of its segments. When encrypted files are stored on the external media (disk or tape) each is secure from unauthorized examination.

Encryption takes place on the segment level. That is, the entire segment is encrypted. The request for encryption is made in the Master File by setting the attribute ENCRYPT to ON.

Encrypting Data

```
SEGMENT=COMPSEG, PARENT=IDSEG, SEGTYPE=S1, ENCRYPT=ON,$
```

You must specify the ENCRYPT parameter before entering any data in the data source. The message NEW FILE... must appear when the encryption is first requested. Encryption

cannot be requested later by a change to the Master File and cannot be removed after it has been requested or any data has been entered in the data source.

Performance Considerations for Encrypted Data

There is a small loss in processing efficiency when data is encrypted. Minimize this loss by grouping the sensitive data fields together on a segment and making them a separate segment of SEGTYPE=U, unique segment, beneath the original segment. For example, suppose the data items on a segment are:

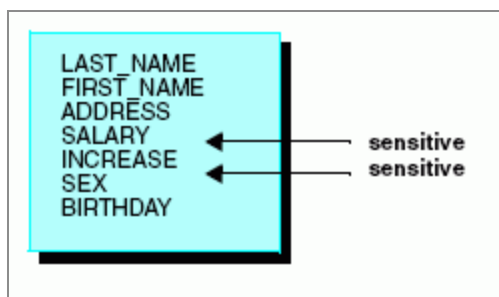

They should be grouped as:

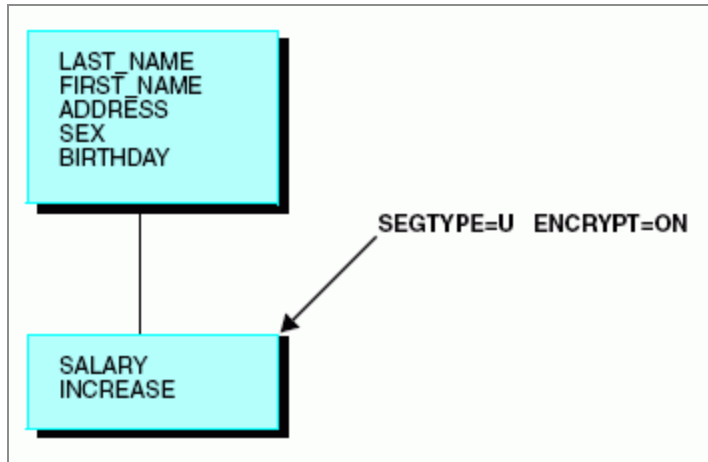

i Note: If you change the DBA password, you must issue the RESTRICT command, as described in [Change a DBA Password](#).

Displaying the Decision Table

When entering security attributes for a Master File, FOCUS creates an internal decision table that lists users and the access privileges. You can display the decision table associated with a given data source whenever the Master File of the data source is not encrypted. Since you have to decrypt your Master File when you change or augment passwords, you can request a decision table picture to check your work. You can also decrypt your Master File to check your decision table. In FOCUS, after you have decrypted your file, type EX DBATABLE and provide the file name when prompted for it.

Display the Decision Table

```
EX DBATABLE filename, {LONG|SHORT}
```

where:

filename

Is the name of the Master File for which you want a decision table.

LONG

Displays 66 characters in the NAME column.

SHORT

Displays 18 characters in the NAME column.



Note: The DBATABLE procedure is supplied with FOCUS. Contact your system administrator if you cannot locate it.

Displaying the Decision Table

The following example displays the decision table for the pers data source.

```

>
ex dbatable
FILE NAME:
pers
>
>
>

PAGE      1

DATA BASE ADMINISTRATOR JONES76
DBAFILE PERS      ON 05/20/03 AT 13.09.07

FILENAME  USER      ACCESS  RESTRICT  NAME          VALUE
-----  -
PERS
          BILL      R       SEGMENT   COMPSEG
          JOHN      R       FIELD     SALARY
          LARRY     R       FIELD     INCREASE
          MARY      U       FIELD     SALARY
          MARY      W       VALUE     SALTEST      INCREASE+SALARY GE SALARY
          MARY      W       VALUE     HISTTEST     DIV NE ' ' AND DATE GT 0
          TOM      RW
          TONY     R       VALUE     IDSEG        DIVISION EQ 'WEST'

```

Setting a Password Externally

Passwords can also be set automatically by an external security system such as RACF®, CA-ACF2®, or CA-Top Secret®. Passwords issued this way are set when FOCUS first enters and may be permanent (that is, not alterable by subsequent SET USER, SET PASS, or -PASS commands). Or they may be default passwords that can be subsequently overridden. The passwords may be permanent for some users, defaults for other users, and not set at all for other users.

The advantage of setting FOCUS passwords externally is that the password need not be known by the user, does not require prompting, and does not have to be embedded in a PROFILE FOCEXEC or an encrypted FOCEXEC.

Passwords set this way must match the passwords specified in the Master Files of the data sources being accessed.

See your installation documentation for FOCUSID installation instructions.

FOCEXEC Security

Most data security issues are best handled by the FOCUS DBA facility. For more information about WebFOCUS DBA exit routines see the *WebFOCUS® Security and Administration* manual. You can also encrypt and decrypt FOCEXECs. For more information about WebFOCUS DBA exit routines see the *ibi™ WebFOCUS® Security and Administration* manual. You can also encrypt and decrypt FOCEXECs.

However, some additional data security facilities are incorporated within Dialogue Manager. These are:

- Suppressing password display.
- Setting passwords in encrypted FOCEXECs.
- Defining variable passwords.
- Encrypting and decrypting FOCEXECs.
- Locking FOCEXEC users out of FOCUS.

External security systems can also set passwords through the FOCUSID exit routine.

Suppressing Password Display

The NODISPLAY attribute can be used with -CRTFORM to create a password prompt with no display of the input characters.

Suppress Password Display

```
<.NODISP.&mypass
```

Suppressing Password Display

Consider the following example in which the attribute .NODISP before the variable instructs the system to accept the response, but not display it, and to set the password to the value that was altered:

```
-SET &MYPASS = '12345678' ;  
-CRTFORM  
-" ENTER YOUR PASSWORD <.NODISP.&MYPASS "  
SET PASS = &MYPASS
```

Setting a Password in an Encrypted FOCEXEC

Passwords can be set within FOCEXECs and tied to different portions of FOCEXECs according to this syntax:

```
-PASS password
```

Since -PASS is a Dialogue Manager command, it executes immediately and is not sent to the FOCSTACK. This means that the user need not issue the password with the SET command. It also means that the password is not visible to anyone. Of course, the procedure must be encrypted so that printing the procedure cannot reveal the password.

Defining Variable Passwords

The Dialogue Manager command -PASS can have a variable attached to it as well as a literal. The syntax is:

```
-PASS &value
```

For example:

```
-PASS &MYPASS  
-PASS &VAL.ENTER YOUR PASSWORD.
```

This command is only visible when editing the FOCEXEC. It does not appear when the ECHO option is ALL and is not printed in a batch run log.

Encrypting and Decrypting a FOCEXEC

Keep the actual text of a stored FOCEXEC confidential while allowing users to execute the FOCEXEC. You do this either because there is confidential information stored in the FOCEXEC or because you do not want the FOCEXEC changed by unauthorized users. You can protect a stored FOCEXEC from unauthorized users with the ENCRYPT command.

Any user can execute an encrypted FOCEXEC, but you must decrypt the FOCEXEC to view it. Only a user with the encrypting password can decrypt the FOCEXEC.

The password selected by a user to ENCRYPT or DECRYPT a FOCEXEC is not viewable by any editor and it is unrelated to the DBA passwords of the files being used.

Encrypt and Decrypt a FOCEXEC

Use the following procedure to encrypt the FOCEXEC named SALERPT:

```
SET PASS = DOHIDE  
ENCRYPT FILE SALERPT FOCEXEC
```

Anyone can execute the FOCEXEC by typing EX SALERPT. The FOCEXEC can only be viewed by decrypting it, as follows:

```
SET PASS = DOHIDE  
DECRYPT FILE SALERPT FOCEXEC
```

Encrypted FOCEXECs cannot be echoed or have the commands displayed on the terminal, so &ECHO has no effect.

Encrypt and Decrypt a FOCEXEC

You use the following procedure to encrypt the FOCEXEC named SALERPT:

```
SET PASS = DOHIDE  
ENCRYPT FILE SALERPT FOCEXEC
```

You use the following procedure to decrypt the FOCEXEC named SALERPT:

```
SET PASS = DOHIDE  
DECRYPT FILE SALERPT FOCEXEC
```

Locking a FOCEXEC User Out of FOCUS

Users can respond to a Dialogue Manager value request with QUIT and return to the FOCUS command level. In situations where it is important to prevent users from entering or returning to FOCUS, the environment can be locked and QUIT can be deactivated by entering in a FOCEXEC:

```
-SET &QUIT=OFF;
```

With QUIT deactivated, any attempt to leave Dialogue Manager produces an error message. Following the error message, the user is reprompted for the needed value.

A user may still terminate the session from inside a locked environment by responding to a prompt with:

```
QUIT FOCUS
```

This returns the user to the operating system, not to the FOCUS command level.

The default setting for &QUIT is ON.

Master Files and Diagrams

This appendix contains descriptions and structure diagrams for the sample data sources used throughout the documentation.

Creating Sample Data Sources

Create sample data sources on your user ID by executing the procedures specified below. These FOCXECs are supplied with FOCUS. If they are not available to you or if they produce error messages, contact your systems administrator or Information Builders Customer Support Services.

To create these files, first make sure you have read access to the Master Files.

Data Source	Load Procedure Name
EMPLOYEE, EDUCFILE, and JOBFILE	<div data-bbox="526 1087 1219 1178" style="background-color: #e6f2ff; padding: 5px; margin-bottom: 10px;">EX EMPTSO</div> <p data-bbox="526 1205 1219 1598">These FOCXECs also test the data sources by generating sample reports. If you are using Hot Screen, remember to press either Enter or the PF3 key after each report. If the EMPLOYEE, EDUCFILE, and JOBFILE data sources already exist on your user ID, the FOCXEC replaces them with new copies. This FOCXEC assumes that the high-level qualifier for the FOCUS data sources is the same as the high-level qualifier for the MASTER PDS that was unloaded from the tape.</p>
SALES PROD	<div data-bbox="526 1633 1219 1724" style="background-color: #e6f2ff; padding: 5px; margin-bottom: 10px;">EX SALES</div> <div data-bbox="526 1745 1219 1835" style="background-color: #e6f2ff; padding: 5px;">EX PROD</div>

Data Source	Load Procedure Name
CAR	None (created automatically during installation).
LEDGER FINANCE REGION COURSES EXPERSON	<div data-bbox="527 373 1221 457">EX LEDGER</div> <div data-bbox="527 478 1221 562">EX FINANCE</div> <div data-bbox="527 583 1221 667">EX REGION</div> <div data-bbox="527 688 1221 772">EX COURSES</div> <div data-bbox="527 793 1221 877">EX EXPERSON</div>
EMPDATA TRAINING COURSE JOBHIST JOBLIST LOCATOR PERSINFO SALHIST	<div data-bbox="527 919 1221 1003">EX LOADPERS</div>
PAYHIST	None (PAYHIST DATA is a sequential data source and is allocated during the installation process).
COMASTER	None (COMASTER is used for debugging other Master Files).
VIDEOTRK and MOVIES	<div data-bbox="527 1675 1221 1759">EX LOADVTRK</div>

Data Source	Load Procedure Name
VIDEOTR2	EX LOADVID2
Gotham Grinds	EX DBLGG
Century Corp: CENTCOMP CENTFIN CENTHR CENTINV CENTORD CENTQA CENTGL CENTSYSF CENTSTMT	 EX LOADCOM EX LOADFIN EX LOADHR EX LOADINV EX LOADORD EX LOADCQA EX LDCENTGL EX LDCENTSY EX LDSTMT

EMPLOYEE Data Source

EMPLOYEE contains sample data about company employees. Its segments are:

EMPINFO

Contains employee IDs, names, and positions.

FUNDTRAN

Specifies employee direct deposit accounts. This segment is unique.

PAYINFO

Contains the employee salary history.

ADDRESS

Contains employee home and bank addresses.

SALINFO

Contains data on employee monthly pay.

DEDUCT

Contains data on monthly pay deductions.

EMPLOYEE also contains cross-referenced segments belonging to the JOBFILE and EDUCFILE files, also described in this appendix. The segments are:

JOBSEG (from JOBFILE)

Describes the job positions held by each employee.

SKILLSEG (from JOBFILE)

Lists the skills required by each position.

SECSEG (from JOBFILE)

Specifies the security clearance needed for each job position.

ATTNDSEG (from EDUCFILE)

Lists the dates that employees attended in-house courses.

COURSESEG (from EDUCFILE)

Lists the courses that the employees attended.

EMPLOYEE Master File

```

FILENAME=EMPLOYEE, SUFFIX=FOC
  SEGNAME=EMPINFO,  SEGTYPE=S1
    FIELDNAME=EMP_ID,      ALIAS=EID,      FORMAT=A9,      $
    FIELDNAME=LAST_NAME,   ALIAS=LN,     FORMAT=A15,     $
    FIELDNAME=FIRST_NAME,  ALIAS=FN,     FORMAT=A10,     $
    FIELDNAME=HIRE_DATE,   ALIAS=HDT,    FORMAT=I6YMD,   $
    FIELDNAME=DEPARTMENT,  ALIAS=DPT,    FORMAT=A10,     $
    FIELDNAME=CURR_SAL,    ALIAS=CSAL,   FORMAT=D12.2M,  $
    FIELDNAME=CURR_JOBCODE, ALIAS=CJC,    FORMAT=A3,      $
    FIELDNAME=ED_HRS,      ALIAS=OJT,    FORMAT=F6.2,    $
  SEGNAME=FUNDTRAN,  SEGTYPE=U,  PARENT=EMPINFO
    FIELDNAME=BANK_NAME,   ALIAS=BN,     FORMAT=A20,     $
    FIELDNAME=BANK_CODE,   ALIAS=BC,     FORMAT=I6S,     $
    FIELDNAME=BANK_ACCT,   ALIAS=BA,     FORMAT=I9S,     $
    FIELDNAME=EFFECT_DATE, ALIAS=EDATE,  FORMAT=I6YMD,   $
  SEGNAME=PAYINFO,  SEGTYPE=SH1, PARENT=EMPINFO
    FIELDNAME=DAT_INC,     ALIAS=DI,     FORMAT=I6YMD,   $
    FIELDNAME=PCT_INC,     ALIAS=PI,     FORMAT=F6.2,    $
    FIELDNAME=SALARY,      ALIAS=SAL,    FORMAT=D12.2M,  $
    FIELDNAME=JOBCODE,     ALIAS=JBC,    FORMAT=A3,      $
  SEGNAME=ADDRESS,  SEGTYPE=S1,  PARENT=EMPINFO
    FIELDNAME=TYPE,        ALIAS=AT,     FORMAT=A4,      $
    FIELDNAME=ADDRESS_LN1, ALIAS=LN1,    FORMAT=A20,     $
    FIELDNAME=ADDRESS_LN2, ALIAS=LN2,    FORMAT=A20,     $
    FIELDNAME=ADDRESS_LN3, ALIAS=LN3,    FORMAT=A20,     $
    FIELDNAME=ACCTNUMBER,  ALIAS=ANO,    FORMAT=I9L,     $
  SEGNAME=SALINFO,  SEGTYPE=SH1, PARENT=EMPINFO
    FIELDNAME=PAY_DATE,    ALIAS=PD,     FORMAT=I6YMD,   $
    FIELDNAME=GROSS,       ALIAS=MO_PAY, FORMAT=D12.2M,  $
  SEGNAME=DEDUCT,   SEGTYPE=S1,  PARENT=SALINFO
    FIELDNAME=DED_CODE,    ALIAS=DC,     FORMAT=A4,      $
    FIELDNAME=DED_AMT,     ALIAS=DA,     FORMAT=D12.2M,  $
  SEGNAME=JOBSEG,   SEGTYPE=KU,  PARENT=PAYINFO, CRFILE=JOBFILE,
    CRKEY=JOBCODE,$
  SEGNAME=SECSEG,   SEGTYPE=KLU, PARENT=JOBSEG,  CRFILE=JOBFILE, $
  SEGNAME=SKILLSEG, SEGTYPE=KL,  PARENT=JOBSEG,  CRFILE=JOBFILE, $
  SEGNAME=ATTNDSEG, SEGTYPE=KM,  PARENT=EMPINFO, CRFILE=EDUCFILE,
    CRKEY=EMP_ID,$
  SEGNAME=COURSEG,  SEGTYPE=KLU, PARENT=ATTNDSEG, CRFILE=EDUCFILE,$

```

SECSEG

Specifies the security clearance needed, if any. This segment is unique.

JOBFILE Master File

```

FILENAME=JOBFILE,  SUFFIX=FOC
SEGNAME=JOBSEG,   SEGTYPE=S1
  FIELDNAME=JOBCODE,  ALIAS=JC,  FORMAT=A3,    INDEX=I,$
  FIELDNAME=JOB_DESC, ALIAS=JD,  FORMAT=A25,    ,,$
SEGNAME=SKILLSEG,  SEGTYPE=S1,  PARENT=JOBSEG
  FIELDNAME=SKILLS,  ALIAS=,     FORMAT=A4,    ,,$
  FIELDNAME=SKILL_DESC, ALIAS=SD, FORMAT=A30,    ,,$
SEGNAME=SECSEG,   SEGTYPE=U,   PARENT=JOBSEG
  FIELDNAME=SEC_CLEAR, ALIAS=SC, FORMAT=A6,     ,,$

```

JOBFILE Structure Diagram

```

SECTION 01
          STRUCTURE OF FOCUS      FILE JOBFILE ON 05/15/03 AT 14.40.06

          JOBSEG
01        S1
*****
*JOBCODE   **I
*JOB_DESC  **
*          **
*          **
*          **
*****
          I
          +-----+
          I          I
          I SECSEG   I SKILLSEG
02        I U        03        I S1
*****          *****
*SEC_CLEAR *      *SKILLS   **
*          *      *SKILL_DESC **
*          *      *          **

```

```

*           *   *           **
*           *   *           **
*****          *****
                *****

```

EDUCFILE Data Source

EDUCFILE contains sample data about company in-house courses. Its segments are:

COURSEG

Contains data on each course.

ATTNDSEG

Specifies which employees attended the courses. Both fields in the segment are key fields. The field EMP_ID in this segment is indexed.

EDUCFILE Master File

```

FILENAME=EDUCFILE, SUFFIX=FOC
SEGNAME=COURSEG, SEGTYPE=S1
  FIELDNAME=COURSE_CODE, ALIAS=CC, FORMAT=A6, $
  FIELDNAME=COURSE_NAME, ALIAS=CD, FORMAT=A30, $
SEGNAME=ATTNDSEG, SEGTYPE=SH2, PARENT=COURSEG
  FIELDNAME=DATE_ATTEND, ALIAS=DA, FORMAT=I6YMD, $
  FIELDNAME=EMP_ID, ALIAS=EID, FORMAT=A9, INDEX=I, $

```

EDUCFILE Structure Diagram

```

SECTION 01
          STRUCTURE OF FOCUS      FILE EDUCFILE ON 05/15/03 AT
14.45.44

          COURSEG
01        S1

```

```

*****
*COURSE_CODE **
*COURSE_NAME **
*           **
*           **
*           **
*****
*****
      I
      I
      I
      I ATTNDSEG
02    I SH2
*****
*DATE_ATTEND **
*EMP_ID      **I
*           **
*           **
*           **
*****
*****

```

SALES Data Source

SALES contains sample data about a dairy company with an affiliated store chain. Its segments are:

STOR_SEG

Lists the stores buying the products.

DAT_SEG

Contains the dates of inventory.

PRODUCT

Contains sales data for each product on each date. The PROD_CODE field is indexed. The RETURNS and DAMAGED fields have the MISSING=ON attribute.

SALES Master File

```

FILENAME=KSALES,   SUFFIX=FOC
SEGNAME=STOR_SEG, SEGTYPE=S1
  FIELDNAME=STORE_CODE, ALIAS=SNO,   FORMAT=A3,   $
  FIELDNAME=CITY,       ALIAS=CTY,   FORMAT=A15,  $
  FIELDNAME=AREA,       ALIAS=LOC,   FORMAT=A1,   $
SEGNAME=DATE_SEG,  PARENT=STOR_SEG, SEGTYPE=SH1,
  FIELDNAME=DATE,      ALIAS=DTE,   FORMAT=A4MD, $
SEGNAME=PRODUCT,  PARENT=DATE_SEG, SEGTYPE=S1,
  FIELDNAME=PROD_CODE, ALIAS=PCODE,  FORMAT=A3,   FIELDTYPE=I,$
  FIELDNAME=UNIT_SOLD, ALIAS=SOLD,   FORMAT=I5,   $
  FIELDNAME=RETAIL_PRICE,ALIAS=RP,   FORMAT=D5.2M,$
  FIELDNAME=DELIVER_AMT, ALIAS=SHIP,  FORMAT=I5,   $
  FIELDNAME=OPENING_AMT, ALIAS=INV,   FORMAT=I5,   $
  FIELDNAME=RETURNS,     ALIAS=RTN,   FORMAT=I3,   MISSING=ON,$
  FIELDNAME=DAMAGED,     ALIAS=BAD,   FORMAT=I3,   MISSING=ON,$

```

SALES Structure Diagram

SECTION 01

STRUCTURE OF FOCUS FILE SALES ON 05/15/03 AT 14.50.28

```

          STOR_SEG
01      S1
*****
*STORE_CODE **
*CITY       **
*AREA       **
*           **
*           **
*****
          I
          I
          I
          I DATE_SEG
02      I SH1
*****
*DATE      **
*           **
*           **

```

```

*                **
*                **
*****
*****
      I
      I
      I
      I PRODUCT
03      I S1
*****
*PROD_CODE      **I
*UNIT_SOLD      **
*RETAIL_PRICE**
*DELIVER_AMT   **
*                **
*****
*****

```

PROD Data Source

The PROD data source lists products sold by a dairy company. It consists of one segment, PRODUCT. The field PROD_CODE is indexed.

PROD Master File

```

FILE=KPROD, SUFFIX=FOC
SEGMENT=PRODUCT, SEGTYPE=S1,
  FIELDNAME=PROD_CODE, ALIAS=PCODE, FORMAT=A3,      FIELDTYPE=I, $
  FIELDNAME=PROD_NAME, ALIAS=ITEM,  FORMAT=A15,     $
  FIELDNAME=PACKAGE,   ALIAS=SIZE,  FORMAT=A12,     $
  FIELDNAME=UNIT_COST, ALIAS=COST,   FORMAT=D5.2M,  $

```

PROD Structure Diagram

```
SECTION 01
          STRUCTURE OF FOCUS   FILE PROD   ON 05/15/03 AT 14.57.38
          PRODUCT
01        S1
*****
*PROD_CODE   **I
*PROD_NAME   **
*PACKAGE     **
*UNIT_COST   **
*           **
*****
*****
```

CAR Data Source

CAR contains sample data about specifications and sales information for rare cars. Its segments are:

ORIGIN

Lists the country that manufactures the car. The field COUNTRY is indexed.

COMP

Contains the car name.

CARREC

Contains the car model.

BODY

Lists the body type, seats, dealer and retail costs, and units sold.

SPECS

Lists car specifications. This segment is unique.

WARANT

Lists the type of warranty.

EQUIP

Lists standard equipment.

The aliases in the CAR Master File are specified without the ALIAS keyword.

CAR Master File

```

FILENAME=CAR, SUFFIX=FOC
SEGNAME=ORIGIN, SEGTYPE=S1
  FIELDNAME=COUNTRY, COUNTRY, A10, FIELDTYPE=I, $
SEGNAME=COMP, SEGTYPE=S1, PARENT=ORIGIN
  FIELDNAME=CAR, CARS, A16, $
SEGNAME=CARREC, SEGTYPE=S1, PARENT=COMP
  FIELDNAME=MODEL, MODEL, A24, $
SEGNAME=BODY, SEGTYPE=S1, PARENT=CARREC
  FIELDNAME=BODYTYPE, TYPE, A12, $
  FIELDNAME=SEATS, SEAT, I3, $
  FIELDNAME=DEALER_COST, DCOST, D7, $
  FIELDNAME=RETAIL_COST, RCOST, D7, $
  FIELDNAME=SALES, UNITS, I6, $
SEGNAME=SPECS, SEGTYPE=U, PARENT=BODY
  FIELDNAME=LENGTH, LEN, D5, $
  FIELDNAME=WIDTH, WIDTH, D5, $
  FIELDNAME=HEIGHT, HEIGHT, D5, $
  FIELDNAME=WEIGHT, WEIGHT, D6, $
  FIELDNAME=WHEELBASE, BASE, D6.1, $
  FIELDNAME=FUEL_CAP, FUEL, D6.1, $
  FIELDNAME=BHP, POWER, D6, $
  FIELDNAME=RPM, RPM, I5, $
  FIELDNAME=MPG, MILES, D6, $
  FIELDNAME=ACCEL, SECONDS, D6, $
SEGNAME=WARRANT, SEGTYPE=S1, PARENT=COMP
  FIELDNAME=WARRANTY, WARR, A40, $
SEGNAME=EQUIP, SEGTYPE=S1, PARENT=COMP
  FIELDNAME=STANDARD, EQUIP, A40, $

```

CAR Structure Diagram

```

SECTION 01          STRUCTURE OF FOCUS   FILE CAR      ON 04/06/07 AT 11.13.56

      ORIGIN
01     S1
*****
* COUNTRY      **I
*
*
*
*****
      I
      I
      I
      I COMP
02     I S1
*****
* CAR
*
*
*
*****
      I
      I-----+-----+
      I CARREC      I WARRANT      I EQUIP
03     I S1          06 I S1          07 I S1
*****          *****          *****
* MODEL         ** WARRANTY      ** STANDARD      **
*
*
*
*****          *****          *****
      I
      I
      I
      I BODY
04     I S1
*****
* BODYTYPE     **
* SEATS        **
* DEALER_COST  **
* RETAIL_COST  **
*
*****
      I
      I
      I
      I SPECS
05     I U
*****
* LENGTH      *
* WIDTH       *
* HEIGHT      *
* WEIGHT      *
*
*****

```

LEDGER Data Source

LEDGER contains sample accounting data. It consists of one segment, TOP. This data source is specified primarily for FML examples. Aliases do not exist for the fields in this Master File, and the commas act as placeholders.

LEDGER Master File

```
FILENAME=LEDGER, SUFFIX=FOC,$
SEGNAME=TOP, SEGTYPE=S2,$
FIELDNAME=YEAR , , FORMAT=A4, $
FIELDNAME=ACCOUNT, , FORMAT=A4, $
FIELDNAME=AMOUNT , , FORMAT=I5C,$
```

LEDGER Structure Diagram

```
SECTION 01
          STRUCTURE OF FOCUS      FILE LEDGER      ON 05/15/03 AT 15.17.08

          TOP
01       S2
*****
*YEAR          **
*ACCOUNT       **
*AMOUNT        **
*              **
*              **
*****
*****
```

FINANCE Data Source

FINANCE contains sample financial data for balance sheets. It consists of one segment, TOP. This data source is specified primarily for FML examples. Aliases do not exist for the fields in this Master File, and the commas act as placeholders.

FINANCE Master File

```
FILENAME=FINANCE, SUFFIX=FOC,$
SEGNAME=TOP, SEGTYPE=S2,$
```

```

FIELDNAME=YEAR      , , FORMAT=A4, $
FIELDNAME=ACCOUNT, , FORMAT=A4, $
FIELDNAME=AMOUNT   , , FORMAT=D12C,$

```

FINANCE Structure Diagram

```

SECTION 01
          STRUCTURE OF FOCUS      FILE FINANCE  ON 05/15/03 AT 15.17.08

          TOP
01        S2
*****
*YEAR          **
*ACCOUNT       **
*AMOUNT        **
*              **
*              **
*****
*****

```

REGION Data Source

REGION contains sample account data for the eastern and western regions of the country. It consists of one segment, TOP. This data source is specified primarily for FML examples. Aliases do not exist for the fields in this Master File, and the commas act as placeholders.

REGION Master File

```

FILENAME=REGION, SUFFIX=FOC,$
SEGNAME=TOP,      SEGTYPE=S1,$
FIELDNAME=ACCOUNT, , FORMAT=A4, $
FIELDNAME=E_ACTUAL, , FORMAT=I5C,$
FIELDNAME=E_BUDGET, , FORMAT=I5C,$
FIELDNAME=W_ACTUAL, , FORMAT=I5C,$
FIELDNAME=W_BUDGET, , FORMAT=I5C,$

```

REGION Structure Diagram

```
SECTION 01
          STRUCTURE OF FOCUS   FILE REGION   ON 05/15/03 AT 15.18.48

          TOP
01        S1
*****
*ACCOUNT      **
*E_ACTUAL     **
*E_BUDGET     **
*W_ACTUAL     **
*              **
*****
*****
```

COURSES Data Source

COURSES contains sample data about education courses. It consists of one segment, CRSESEG1. The field DESCRIPTION has a format of TEXT (TX).

COURSES Master File

```
FILENAME=COURSES, SUFFIX=FOC,$
SEGNAME=CRSESEG1, SEGTYPE=S1, $
  FIELDNAME=COURSE_CODE, ALIAS=CC,   FORMAT=A6,   FIELDTYPE=I, $
  FIELDNAME=COURSE_NAME, ALIAS=CN,   FORMAT=A30,   $
  FIELDNAME=DURATION,    ALIAS=DAYS,  FORMAT=I3,   $
  FIELDNAME=DESCRIPTION, ALIAS=CDESC, FORMAT=TX50,  $
```

COURSES Structure Diagram

```
SECTION 01
          STRUCTURE OF FOCUS   FILE COURSES   ON 05/15/03 AT
```

12.26.05

```

          CRSESEG1
01      S1
*****
*COURSE_CODE **I
*COURSE_NAME **
*DURATION    **
*DESCRIPTION **T
*           **
*****
*****

```

EMPDATA Data Source

EMPDATA contains sample data about company employees. It consists of one segment, EMPDATA. The PIN field is indexed. The AREA field is a temporary field.

EMPDATA Master File

```

FILENAME=EMPDATA, SUFFIX=FOC
SEGNAME=EMPDATA, SEGTYPE=S1
  FIELDNAME=PIN,           ALIAS=ID,           FORMAT=A9,   INDEX=I,   $
  FIELDNAME=LASTNAME,     ALIAS=LN,           FORMAT=A15,   $
  FIELDNAME=FIRSTNAME,   ALIAS=FN,           FORMAT=A10,   $
  FIELDNAME=MIDINITIAL,  ALIAS=MI,           FORMAT=A1,    $
  FIELDNAME=DIV,         ALIAS=CDIV,         FORMAT=A4,    $
  FIELDNAME=DEPT,        ALIAS=CDEPT,        FORMAT=A20,   $
  FIELDNAME=JOBCLASS,    ALIAS=CJCLAS,       FORMAT=A8,    $
  FIELDNAME=TITLE,       ALIAS=CFUNC,        FORMAT=A20,   $
  FIELDNAME=SALARY,      ALIAS=CSAL,         FORMAT=D12.2M, $
  FIELDNAME=HIREDATE,    ALIAS=HDAT,         FORMAT=YMD,   $
$
DEFINE AREA/A13=DECODE DIV (NE 'NORTH EASTERN' SE 'SOUTH EASTERN'
CE 'CENTRAL' WE 'WESTERN' CORP 'CORPORATE' ELSE 'INVALID AREA');$

```

EMPDATA Structure Diagram

```
SECTION 01
          STRUCTURE OF FOCUS      FILE EMPDATA  ON 05/15/03 AT 14.49.09

          EMPDATA
01        S1
*****
*PIN          **I
*LASTNAME     **
*FIRSTNAME    **
*MIDINITIAL   **
*             **
*****
*****
```

EXPERSON Data Source

The EXPERSON data source contains personal data about individual employees. It consists of one segment, ONESEG.

EXPERSON Master File

```
FILE=EXPERSON      , SUFFIX=FOC
SEGMENT=ONESEG, $
  FIELDNAME=SOC_SEC_NO      , ALIAS=SSN          , USAGE=A9      , $
  FIELDNAME=FIRST_NAME     , ALIAS=FN           , USAGE=A9      , $
  FIELDNAME=LAST_NAME      , ALIAS=LN           , USAGE=A10     , $
  FIELDNAME=AGE             , ALIAS=YEARS        , USAGE=I2      , $
  FIELDNAME=SEX             , ALIAS=              , USAGE=A1      , $
  FIELDNAME=MARITAL_STAT   , ALIAS=MS           , USAGE=A1      , $
  FIELDNAME=NO_DEP         , ALIAS=NDP          , USAGE=I3      , $
  FIELDNAME=DEGREE         , ALIAS=              , USAGE=A3      , $
  FIELDNAME=NO_CARS        , ALIAS=CARS         , USAGE=I3      , $
  FIELDNAME=ADDRESS        , ALIAS=              , USAGE=A14     , $
  FIELDNAME=CITY           , ALIAS=              , USAGE=A10     , $
  FIELDNAME=WAGE           , ALIAS=PAY          , USAGE=D10.2SM , $
  FIELDNAME=CATEGORY       , ALIAS=STATUS       , USAGE=A1      , $
  FIELDNAME=SKILL_CODE     , ALIAS=SKILLS       , USAGE=A5      , $
```

```

FIELDNAME=DEPT_CODE      ,ALIAS=WHERE      ,USAGE=A4      ,,$
FIELDNAME=TEL_EXT        ,ALIAS=EXT        ,USAGE=I4      ,,$
FIELDNAME=DATE_EMP       ,ALIAS=BASE_DATE  ,USAGE=I6YMTD  ,,$
FIELDNAME=MULTIPLIER     ,ALIAS=RATIO      ,USAGE=D5.3    ,,$

```

EXPERSON Structure Diagram

```

SECTION 01
          STRUCTURE OF FOCUS      FILE EXPERSO  ON 05/15/03 AT 14.50.58

```

```

          ONESEG
01      S1
*****
*SOC_SEC_NO  **
*FIRST_NAME  **
*LAST_NAME   **
*AGE         **
*           **
*****
*****

```

TRAINING Data Source

TRAINING contains sample data about training courses for employees. It consists of one segment, TRAINING. The PIN field is indexed. The EXPENSES, GRADE, and LOCATION fields have the MISSING=ON attribute.

TRAINING Master File

```

FILENAME=TRAINING, SUFFIX=FOC
SEGNAME=TRAINING, SEGTYPE=SH3
FIELDNAME=PIN,      ALIAS=ID,      FORMAT=A9,      INDEX=I,      $
FIELDNAME=COURSESTART, ALIAS=CSTART,  FORMAT=YMD,      $
FIELDNAME=COURSECODE, ALIAS=CCOD,    FORMAT=A7,      $
FIELDNAME=EXPENSES,  ALIAS=COST,    FORMAT=D8.2,    MISSING=ON    $

```

```

FIELDNAME=GRADE,      ALIAS=GRA,    FORMAT=A2,    MISSING=ON, $
FIELDNAME=LOCATION,    ALIAS=LOC,    FORMAT=A6,    MISSING=ON, $

```

TRAINING Structure Diagram

```

SECTION 01
          STRUCTURE OF FOCUS      FILE TRAINING ON 05/15/03 AT 14.51.28

          TRAINING
01        SH3
*****
*PIN          **I
*COURSESTART **
*COURSECODE   **
*EXPENSES     **
*             **
*****
*****

```

COURSE Data Source

COURSE contains sample data about education courses. It consists of one segment, CRSELIST.

COURSE Master File

```

FILENAME=COURSE,      SUFFIX=FOC
SEGNAME=CRSELIST,    SEGTYPE=S1
FIELDNAME=COURSECODE, ALIAS=CCOD,    FORMAT=A7,    INDEX=I,    $
FIELDNAME=CTITLE,     ALIAS=COURSE,   FORMAT=A35,   $
FIELDNAME=SOURCE,     ALIAS=ORG,      FORMAT=A35,   $
FIELDNAME=CLASSIF,    ALIAS=CLASS,    FORMAT=A10,   $
FIELDNAME=TUITION,    ALIAS=FEE,      FORMAT=D8.2,  MISSING=ON, $
FIELDNAME=DURATION,   ALIAS=DAYS,     FORMAT=A3,    MISSING=ON, $
FIELDNAME=DESCRIPTN1, ALIAS=DESC1,    FORMAT=A40,   $

```

```

FIELDNAME=DESCRIPTN2, ALIAS=DESC2, FORMAT=A40, $
FIELDNAME=DESCRIPTN2, ALIAS=DESC3, FORMAT=A40, $

```

COURSE Structure Diagram

```

SECTION 01
          STRUCTURE OF FOCUS      FILE COURSE      ON 05/15/03 AT 12.26.05

          CRSELIST
01      S1
*****
*COURSECODE  **I
*CTITLE      **
*SOURCE      **
*CLASSIF     **
*            **
*****
*****

```

JOBHIST Data Source

JOBHIST contains information about employee jobs. Both the PIN and JOBSTART fields are keys. The PIN field is indexed.

JOBHIST Master File

```

FILENAME=JOBHIST, SUFFIX=FOC
SEGNAME=JOBHIST, SEGTYPE=SH2
FIELDNAME=PIN, ALIAS=ID, FORMAT=A9, INDEX=I , $
FIELDNAME=JOBSTART, ALIAS=SDAT, FORMAT=YMD, $
FIELDNAME=JOBCLASS, ALIAS=JCLASS, FORMAT=A8, $
FIELDNAME=FUNCTITLE, ALIAS=FUNC, FORMAT=A20, $

```

JOBHIST Structure Diagram

```
SECTION 01
  STRUCTURE OF FOCUS   FILE JOBHIST   ON 01/22/08 AT 16.23.46
  JOBHIST
  01      SH2
  *****
  *PIN          **I
  *JOBSTART     **
  *JOBCLASS     **
  *FUNCTITLE    **
  *             **
  *****
  *****
```

JOBLIST Data Source

JOBLIST contains information about jobs. The JOBCLASS field is indexed.

JOBLIST Master File

```
FILENAME=JOBLIST, SUFFIX=FOC
SEGNAME=JOBSEG,  SEGTYPE=S1
FIELDNAME=JOBCLASS, ALIAS=JCLASS,  FORMAT=A8,  INDEX=I , $
FIELDNAME=CATEGORY, ALIAS=JGROUP,  FORMAT=A25, $
FIELDNAME=JOBDESC,  ALIAS=JDESC,  FORMAT=A40, $
FIELDNAME=LOWSAL,   ALIAS=LSAL,   FORMAT=D12.2M, $
FIELDNAME=HIGHSAL,  ALIAS=HSAL,   FORMAT=D12.2M, $
DEFINE GRADE/A2=EDIT (JCLASS,'$$$99');$
DEFINE LEVEL/A25=DECODE GRADE (08 'GRADE 8' 09 'GRADE 9' 10
'GRADE 10' 11 'GRADE 11' 12 'GRADE 12' 13 'GRADE 13' 14 'GRADE 14');$
```

JOBLIST Structure Diagram

```
SECTION 01
                STRUCTURE OF FOCUS   FILE JOBLIST   ON 01/22/08 AT
16.24.52
                JOBSEG
  01           S1
*****
*JOBCLASS     **I
*CATEGORY     **
*JOBDESC      **
*LOWSAL       **
*             **
*****
*****
```

LOCATOR Data Source

JOBHIST contains information about employee location and phone number. The PIN field is indexed.

LOCATOR Master File

```
FILENAME=LOCATOR, SUFFIX=FOC
SEGNAME=LOCATOR,  SEGTYPE=S1,
FIELDNAME=PIN,    ALIAS=ID_NO,   FORMAT=A9,    INDEX=I,    $
FIELDNAME=SITE,   ALIAS=SITE,   FORMAT=A25,   $
FIELDNAME=FLOOR,  ALIAS=FL,    FORMAT=A3,    $
FIELDNAME=ZONE,   ALIAS=ZONE,   FORMAT=A2,    $
FIELDNAME=BUS_PHONE, ALIAS=BTEL,   FORMAT=A5,    $
```

LOCATOR Structure Diagram

```

SECTION 01
                STRUCTURE OF FOCUS   FILE LOCATOR   ON 01/22/08 AT
16.26.55
                LOCATOR
  01           S1
*****
*PIN           **I
*SITE          **
*FLOOR         **
*ZONE          **
*              **
*****
*****

```

PERSINFO Data Source

PERSINFO contains employee personal information. The PIN field is indexed.

PERSINFO Master File

```

FILENAME=PERSINFO, SUFFIX=FOC
SEGNAME=PERSONAL, SEGTYPE=S1
FIELDNAME=PIN,           ALIAS=ID,           FORMAT=A9,     INDEX=I,     $
FIELDNAME=INCAREOF,     ALIAS=ICO,           FORMAT=A35,    $
FIELDNAME=STREETNO,    ALIAS=STR,           FORMAT=A20,    $
FIELDNAME=APT,          ALIAS=APT,           FORMAT=A4,     $
FIELDNAME=CITY,         ALIAS=CITY,          FORMAT=A20,    $
FIELDNAME=STATE,       ALIAS=PROV,          FORMAT=A4,     $
FIELDNAME=POSTALCODE,  ALIAS=ZIP,           FORMAT=A10,    $
FIELDNAME=COUNTRY,     ALIAS=CTRY,          FORMAT=A15,    $
FIELDNAME=HOMEPHONE,   ALIAS=TEL,           FORMAT=A10,    $
FIELDNAME=EMERGENCYNO, ALIAS=ENO,           FORMAT=A10,    $
FIELDNAME=EMERGCONTACT, ALIAS=ENAME,         FORMAT=A35,    $
FIELDNAME=RELATIONSHIP, ALIAS=REL,           FORMAT=A8,     $
FIELDNAME=BIRTHDATE,   ALIAS=BDAT,          FORMAT=YMD,    $

```

PERSINFO Structure Diagram

```
SECTION 01
  STRUCTURE OF FOCUS   FILE PERSINFO ON 01/22/08 AT 16.27.24
  PERSONAL
  01      S1
  *****
  *PIN          **I
  *INCAREOF     **
  *STREETNO     **
  *APT          **
  *             **
  *****
  *****
```

SALHIST Data Source

SALHIST contains information about employee salary history. The PIN field is indexed. Both the PIN and EFFECTDATE fields are keys.

SALHIST Master File

```
FILENAME=SALHIST,  SUFFIX=FOC
SEGNAME=SLHISTRY, SEGTYPE=SH2
FIELDNAME=PIN,     ALIAS=ID,     FORMAT=A9,     INDEX=I,     $
FIELDNAME=EFFECTDATE, ALIAS=EDAT,  FORMAT=YMD,     $
FIELDNAME=OLDSALARY, ALIAS=OSAL,  FORMAT=D12.2,  $
```

SALHIST Structure Diagram

```
SECTION 01
  STRUCTURE OF FOCUS   FILE SALHIST ON 01/22/08 AT 16.28.02
  SLHISTRY
  01      SH2
```

```

*****
*PIN          **I
*EFFECTDATE  **
*OLDSALARY   **
*            **
*            **
*****
*****

```

PAYHIST File

The PAYHIST data source contains the employees' salary history. It consists of one segment, PAYSEG. The SUFFIX attribute indicates that the data file is a fixed-format sequential file.

PAYHIST Master File

```

FILENAME=PAYHIST,  SUFFIX=FIX
SEGMENT=PAYSEG,$
  FIELDNAME=SOC_SEC_NO,  ALIAS=SSN,      USAGE=A9,      ACTUAL=A9, $
  FIELDNAME=DATE_OF_IN,  ALIAS=INCDATE,  USAGE=I6YMTD,  ACTUAL=A6, $
  FIELDNAME=AMT_OF_INC,  ALIAS=RAISE,     USAGE=D6.2,    ACTUAL=A10,$
  FIELDNAME=PCT_INC,     ALIAS=,          USAGE=D6.2,    ACTUAL=A6, $
  FIELDNAME=NEW_SAL,     ALIAS=CURR_SAL,  USAGE=D10.2,   ACTUAL=A11,$
  FIELDNAME=FILL,        ALIAS=,          USAGE=A38,     ACTUAL=A38,$

```

PAYHIST Structure Diagram

```

SECTION 01
          STRUCTURE OF FIX      FILE PAYHIST ON 05/15/03 AT 14.51.59

          PAYSEG
01        S1
*****
*SOC_SEC_NO **

```

```

*DATE_OF_IN  **
*AMT_OF_INC  **
*PCT_INC     **
*           **
*****
*****

```

COMASTER File

The COMASTER file is used to display the file structure and contents of each segment in a data source. Since COMASTER is used for debugging other Master Files, a corresponding FOCEXEC does not exist for the COMASTER file. Its segments are:

- FILEID, which lists file information.
- RECID, which lists segment information.
- FIELDID, which lists field information.
- DEFREC, which lists a description record.
- PASSREC, which lists read/write access.
- CRSEG, which lists cross-reference information for segments.
- ACCSEG, which lists DBA information.

COMASTER Master File

```

SUFFIX=COM,SEGNAME=FILEID
FIELDNAME=FILENAME      ,FILE           ,A8 ,      , $
FIELDNAME=FILE SUFFIX  ,SUFFIX         ,A8 ,      , $
FIELDNAME=FDFCENT      ,FDFC           ,A4 ,      , $
FIELDNAME=FYRTHRESH    ,FYRT           ,A2 ,      , $
SEGNAME=RECID
FIELDNAME=SEGNAME       ,SEGMENT        ,A8 ,      , $
FIELDNAME=SEGTYPE      ,SEGTYPE        ,A4 ,      , $
FIELDNAME=SEGSIZE      ,SEGSIZE        ,I4 ,      A4, $
FIELDNAME=PARENT       ,PARENT         ,A8 ,      , $
FIELDNAME=CRKEY        ,VKEY           ,A66,      , $
SEGNAME=FIELDID

```

```

FIELDNAME=FIELDNAME      ,FIELD      ,A66,      ,$
FIELDNAME=ALIAS          ,SYNONYM    ,A66,      ,$
FIELDNAME=FORMAT         ,USAGE      ,A8 ,      ,$
FIELDNAME=ACTUAL         ,ACTUAL     ,A8 ,      ,$
FIELDNAME=AUTHORITY      ,AUTHCODE   ,A8 ,      ,$
FIELDNAME=FIELDTYPE      ,INDEX      ,A8 ,      ,$
FIELDNAME=TITLE          ,TITLE      ,A64,      ,$
FIELDNAME=HELPMESSAGE    ,MESSAGE    ,A256,     ,$
FIELDNAME=MISSING        ,MISSING    ,A4 ,      ,$
FIELDNAME=ACCEPTS        ,ACCEPTABLE ,A255,     ,$
FIELDNAME=RESERVED       ,RESERVED   ,A44 ,     ,$
FIELDNAME=DEFCENT        ,DFC        ,A4 ,      ,$
FIELDNAME=YRTHRESH       ,YRT        ,A4 ,      ,$
SEGNAME=DEFREC
FIELDNAME=DEFINITION     ,DESCRIPTION ,A44,      ,$
SEGNAME=PASSREC,PARENT=FILEID
FIELDNAME=READ/WRITE     ,RW         ,A32,      ,$
SEGNAME=CRSEG,PARENT=RECID
FIELDNAME=CRFILENAME     ,CRFILE     ,A8 ,      ,$
FIELDNAME=CRSEGNAME     ,CRSEGMENT  ,A8 ,      ,$
FIELDNAME=ENCRYPT         ,ENCRYPT     ,A4 ,      ,$
SEGNAME=ACCSEG,PARENT=DEFREC
FIELDNAME=DBA            ,DBA        ,A8 ,      ,$
FIELDNAME=DBAFILE       ,           ,A8 ,      ,$
FIELDNAME=USER           ,PASS       ,A8 ,      ,$
FIELDNAME=ACCESS         ,ACCESS     ,A8 ,      ,$
FIELDNAME=RESTRICT       ,RESTRICT   ,A8 ,      ,$
FIELDNAME=NAME           ,NAME       ,A66,      ,$
FIELDNAME=VALUE          ,VALUE      ,A80,      ,$

```

COMASTER Structure Diagram

SECTION 01

STRUCTURE OF EXTERNAL FILE COMASTER ON 05/15/03 AT 14.53.38

```

      FILKID
01  SO
*****
*FILENAME **
*FILE SUFFIX **
*DEFICENT **
*FUTURISM **
*****
      I
      +-----+
      I          I
      I  RRCD   I  PASSREC
02  I  N      07  I  N
*****
*SEGNAME **      *READ/WRIT **
*SEGTYPE **      *          **
*SEGISE **        *          **
*PARNT **         *          **
*****

      I
      +-----+
      I          I
      I  FIELDID  I  CRSEG
03  I  N          06  I  N
*****
*FIELDNAME **    *CRFILENAME **
*ALIAS **        *CRSEGNAME **
*FORMAT **       *ENCRYPT **
*ACTUAL **       *          **
*****

      I
      I
      I
      I  DEFREC
04  I  N
*****
*DEFINITION **
*          **
*          **
*          **
*****

      I
      I
      I
      I  ACCSEG
05  I  N
*****
*DBA **
*DBAFIL **
*USER **
*ACCESS **
*****

```

VIDEOTRK, MOVIES, and ITEMS Data Sources

VIDEOTRK contains sample data about customer, rental, and purchase information for a video rental business. It can be joined to the MOVIES or ITEMS data source. VIDEOTRK and MOVIES are used in examples that illustrate the use of the Maintain Data facility.

VIDEOTRK Master File

```

FILENAME=VIDEOTRK, SUFFIX=FOC
SEGNAME=CUST,      SEGTYPE=S1

```



```

FIELDNAME=CUSTID,      ALIAS=CIN,           FORMAT=A4,    $
FIELDNAME=LASTNAME,   ALIAS=LN,            FORMAT=A15,   $
FIELDNAME=FIRSTNAME,  ALIAS=FN,            FORMAT=A10,   $
FIELDNAME=EXPDATE,    ALIAS=EXDAT,         FORMAT=YMD,   $
FIELDNAME=PHONE,      ALIAS=TEL,           FORMAT=A10,   $
FIELDNAME=STREET,     ALIAS=STR,           FORMAT=A20,   $
FIELDNAME=CITY,       ALIAS=CITY,          FORMAT=A20,   $
FIELDNAME=STATE,      ALIAS=PROV,          FORMAT=A4,    $
FIELDNAME=ZIP,        ALIAS=POSTAL_CODE,  FORMAT=A9,    $
SEGNAME=TRANSDAT,    SEGTYPE=SH1, PARENT=CUST
FIELDNAME=TRANSDATE, ALIAS=OUTDATE,      FORMAT=YMD,   $
SEGNAME=SALES,       SEGTYPE=S2, PARENT=TRANSDAT
FIELDNAME=PRODCODE,  ALIAS=PCOD,          FORMAT=A6,    $
FIELDNAME=TRANSCODE, ALIAS=TCOD,          FORMAT=I3,    $
FIELDNAME=QUANTITY,  ALIAS=NO,            FORMAT=I3S,   $
FIELDNAME=TRANSTOT,  ALIAS=TTOT,          FORMAT=F7.2S, $
SEGNAME=RENTALS,     SEGTYPE=S2, PARENT=TRANSDAT
FIELDNAME=MOVIECODE, ALIAS=MCOD,          FORMAT=A6, INDEX=I, $
FIELDNAME=COPY,      ALIAS=COPY,          FORMAT=I2,    $
FIELDNAME=RETURNDATE, ALIAS=INDATE,        FORMAT=YMD,   $
FIELDNAME=FEE,       ALIAS=FEE,           FORMAT=F5.2S, $

```

VIDEOTRK Structure Diagram

SECTION 01

STRUCTURE OF FOCUS

FILE VIDEOTRK ON 05/15/03 AT 12.25.19

```

          CUST
01      S1
*****
*CUSTID      **
*LASTNAME    **
*FIRSTNAME   **
*EXPDATE     **
*            **
*****
*****
          I
          I
          I
          I TRANSDAT
02      I SH1
*****

```

```

*TRANSDATE    **
*              **
*              **
*              **
*              **
*****
*****
      I
      +-----+
      I              I
      I SALES        I RENTALS
03    I S2          04    I S2
*****          *****
*PRODCODE     **   *MOVIECODE  **I
*TRANSCODE    **   *COPY        **
*QUANTITY     **   *RETURNDATE **
*TRANSTOT     **   *FEE         **
*              **   *              **
*****          *****
*****          *****

```

MOVIES Master File

```

FILENAME=MOVIES,    SUFFIX=FOC
SEGNAME=MOVINFO,   SEGTYPE=S1
  FIELDNAME=MOVIECODE, ALIAS=MCOD,  FORMAT=A6, INDEX=I, $
  FIELDNAME=TITLE,     ALIAS=MTL,   FORMAT=A39,  $
  FIELDNAME=CATEGORY,  ALIAS=CLASS, FORMAT=A8,   $
  FIELDNAME=DIRECTOR,  ALIAS=DIR,   FORMAT=A17,  $
  FIELDNAME=RATING,    ALIAS=RTG,   FORMAT=A4,   $
  FIELDNAME=RELDATE,   ALIAS=RDAT,  FORMAT=YMD,  $
  FIELDNAME=WHOLESALEPR, ALIAS=WPRC,  FORMAT=F6.2, $
  FIELDNAME=LISTPR,    ALIAS=LPRC,  FORMAT=F6.2, $
  FIELDNAME=COPIES,    ALIAS=NOC,   FORMAT=I3,   $

```

MOVIES Structure Diagram

SECTION 01

STRUCTURE OF FOCUS

FILE MOVIES

ON 05/15/03 AT 12.26.05

```

          MOVINFO
01      S1
*****
*MOVIECODE  **I
*TITLE      **
*CATEGORY   **
*DIRECTOR   **
*           **
*****
*****

```

ITEMS Master File

```

FILENAME=ITEMS,  SUFFIX=FOC
SEGNAME=ITMINFO, SEGTYPE=S1
  FIELDNAME=PRODCODE, ALIAS=PCOD,  FORMAT=A6,  INDEX=I,  $
  FIELDNAME=PRODNAME, ALIAS=PROD,  FORMAT=A20,  $
  FIELDNAME=OURCOST,  ALIAS=W COST,  FORMAT=F6.2,  $
  FIELDNAME=RETAILPR, ALIAS=PRICE,  FORMAT=F6.2,  $
  FIELDNAME=ON_HAND,  ALIAS=NUM,    FORMAT=I5,    $

```

ITEMS Structure Diagram

```

SECTION 01
          STRUCTURE OF FOCUS      FILE ITEMS      ON 05/15/03 AT 12.26.05

          ITMINFO
01      S1
*****
*PRODCODE  **I
*PRODNAME  **
*OURCOST   **
*RETAILPR  **
*           **
*****
*****

```

VIDEOTR2 Data Source

VIDEOTR2 contains sample data about customer, rental, and purchase information for a video rental business. It consists of four segments.

VIDEOTR2 Master File

```

FILENAME=VIDEOTR2, SUFFIX=FOC
SEGNAME=CUST,      SEGTYPE=S1
  FIELDNAME=CUSTID,    ALIAS=CIN,      FORMAT=A4,      $
  FIELDNAME=LASTNAME,  ALIAS=LN,      FORMAT=A15,     $
  FIELDNAME=FIRSTNAME, ALIAS=FN,      FORMAT=A10,     $
  FIELDNAME=EXPDATE,   ALIAS=EXDAT,   FORMAT=YMD,     $
  FIELDNAME=PHONE,     ALIAS=TEL,     FORMAT=A10,     $
  FIELDNAME=STREET,    ALIAS=STR,     FORMAT=A20,     $
  FIELDNAME=CITY,      ALIAS=CITY,    FORMAT=A20,     $
  FIELDNAME=STATE,     ALIAS=PROV,    FORMAT=A4,      $
  FIELDNAME=ZIP,       ALIAS=POSTAL_CODE, FORMAT=A9,      $
  FIELDNAME=EMAIL,     ALIAS=EMAIL,   FORMAT=A18,     $
SEGNAME=TRANSDAT, SEGTYPE=SH1, PARENT=CUST
  FIELDNAME=TRANSDATE, ALIAS=OUTDATE, FORMAT=HYMDI,   $
SEGNAME=SALES, SEGTYPE=S2, PARENT=TRANSDAT
  FIELDNAME=TRANSCODE, ALIAS=TCOD,    FORMAT=I3,      $
  FIELDNAME=QUANTITY,  ALIAS=NO,      FORMAT=I3S,     $
  FIELDNAME=TRANSTOT,  ALIAS=TTOT,    FORMAT=F7.2S,   $
SEGNAME=RENTALS, SEGTYPE=S2, PARENT=TRANSDAT
  FIELDNAME=MOVIECODE, ALIAS=MCOD,    FORMAT=A6, INDEX=I, $
  FIELDNAME=COPY,      ALIAS=COPY,    FORMAT=I2,      $
  FIELDNAME=RETURNDATE, ALIAS=INDATE,  FORMAT=YMD,     $
  FIELDNAME=FEE,       ALIAS=FEE,     FORMAT=F5.2S,   $

```

VIDEOTR2 Structure Diagram

```

SECTION 01
  STRUCTURE OF FOCUS      FILE VIDEOTR2 ON 05/15/03 AT 16.45.48

      CUST
01    S1
*****

```

```

*CUSTID      **
*LASTNAME    **
*FIRSTNAME   **
*EXPDATE     **
*            **
*****
*****
      I
      I
      I
      I TRANSDAT
02      I SH1
*****
*TRANSDATE   **
*            **
*            **
*            **
*            **
*****
*****
      I
      +-----+
      I              I
      I SALES        I RENTALS
03      I S2          04      I S2
*****          *****
*TRANSCODE   **  *MOVIECODE **I
*QUANTITY    **  *COPY       **
*TRANSTOT    **  *RETURNDATE **
*            **  *FEE        **
*            **  *            **
*****          *****
*****          *****

```

Gotham Grinds Data Sources

Gotham Grinds is a group of data sources that contain sample data about a specialty items company.

- GGDEMOG contains demographic information about the customers of Gotham Grinds, a company that sells specialty items like coffee, gourmet snacks, and gifts. It consists of one segment, DEMOG01.
- GGORDER contains order information for Gotham Grinds. It consists of two segments,

ORDER01 and ORDER02.

- GGPRODS contains product information for Gotham Grinds. It consists of one segment, PRODS01.
- GGSALES contains sales information for Gotham Grinds. It consists of one segment, SALES01.
- GGSTORES contains information for each of Gotham Grinds 12 stores in the United States. It consists of one segment, STORES01.

GGDEMOG Master File

```

FILENAME=GGDEMOG, SUFFIX=FOC
SEGNAME=DEMOG01, SEGTYPE=S1
  FIELD=ST,          ALIAS=E02, FORMAT=A02, INDEX=I,TITLE='State',
  DESC='State', $
  FIELD=HH,          ALIAS=E03, FORMAT=I09, TITLE='Number of Households',
  DESC='Number of Households', $
  FIELD=AVGHHSZ98, ALIAS=E04, FORMAT=I09, TITLE='Average Household Size',
  DESC='Average Household Size', $
  FIELD=MEDHHI98, ALIAS=E05, FORMAT=I09, TITLE='Median Household
Income',
  DESC='Median Household Income', $
  FIELD=AVGHHI98, ALIAS=E06, FORMAT=I09, TITLE='Average Household
Income',
  DESC='Average Household Income', $
  FIELD=MALEPOP98, ALIAS=E07, FORMAT=I09, TITLE='Male Population',
  DESC='Male Population', $
  FIELD=FEMPOP98, ALIAS=E08, FORMAT=I09, TITLE='Female Population',
  DESC='Female Population', $
  FIELD=P15T01998, ALIAS=E09, FORMAT=I09, TITLE='15 to 19',
  DESC='Population 15 to 19 years old', $
  FIELD=P20T02998, ALIAS=E10, FORMAT=I09, TITLE='20 to 29',
  DESC='Population 20 to 29 years old', $
  FIELD=P30T04998, ALIAS=E11, FORMAT=I09, TITLE='30 to 49',
  DESC='Population 30 to 49 years old', $
  FIELD=P50T06498, ALIAS=E12, FORMAT=I09, TITLE='50 to 64',
  DESC='Population 50 to 64 years old', $
  FIELD=P650VR98, ALIAS=E13, FORMAT=I09, TITLE='65 and over',
  DESC='Population 65 and over', $

```

GGDEMOG Structure Diagram

```
SECTION 01
  STRUCTURE OF FOCUS   FILE GGDEMOG   ON 05/15/03 AT 12.26.05

      GGDEMOG
01      S1
*****
*ST          **I
*HH          **
*AVGHHSZ98   **
*MEDHHI98    **
*            **
*****
*****
```

GGORDER Master File

```
FILENAME=GGORDER, SUFFIX=FOC,$
SEGNAME=ORDER01, SEGTYPE=S1,$
  FIELD=ORDER_NUMBER, ALIAS=ORDN01,   FORMAT=I6,  TITLE='Order,Number',
  DESC='Order Identification Number', $
  FIELD=ORDER_DATE,   ALIAS=DATE,     FORMAT=MDY, TITLE='Order,Date',
  DESC='Date order was placed', $
  FIELD=STORE_CODE,  ALIAS=STCD,     FORMAT=A5,  TITLE='Store,Code',
  DESC='Store Identification Code (for order)', $
  FIELD=PRODUCT_CODE, ALIAS=PCD,     FORMAT=A4,  TITLE='Product,Code',
  DESC='Product Identification Code (for order)', $
  FIELD=QUANTITY,    ALIAS=ORDUNITS, FORMAT=I8,  TITLE='Ordered,Units',
  DESC='Quantity Ordered', $
SEGNAME=ORDER02, SEGTYPE=KU, PARENT=ORDER01, CRFILE=GGPRODS, CRKEY=PCD,
CRSEG=PRODS01  , $
```

GGORDER Structure Diagram

```
SECTION 01
  STRUCTURE OF FOCUS   FILE GGORDER   ON 05/15/03 AT 16.45.48
```

```

          GGORDER
01      S1
*****
*ORDER_NUMBER**
*ORDER_DATE  **
*STORE_CODE  **
*PRODUCT_CODE**
*           **
*****
*****
          I
          I
          I
          I ORDER02
02      I KU
.....
:PRODUCT_ID  :K
:PRODUCT_DESC:
:VENDOR_CODE :
:VENDOR_NAME :
:           :
:.....:

```

GGPRODS Master File

```

FILENAME=GGPRODS, SUFFIX=FOC
SEGNAME=PRODS01, SEGTYPE=S1
  FIELD=PRODUCT_ID, ALIAS=PCD, FORMAT=A4, INDEX=I, TITLE='Product,Code',
  DESC='Product Identification Code', $
  FIELD=PRODUCT_DESCRIPTION, ALIAS=PRODUCT, FORMAT=A16, TITLE='Product',
  DESC='Product Name', $
  FIELD=VENDOR_CODE, ALIAS=VCD, FORMAT=A4, INDEX=I, TITLE='Vendor ID',
  DESC='Vendor Identification Code', $
  FIELD=VENDOR_NAME, ALIAS=VENDOR, FORMAT=A23, TITLE='Vendor Name',
  DESC='Vendor Name', $
  FIELD=PACKAGE_TYPE, ALIAS=PACK, FORMAT=A7, TITLE='Package',
  DESC='Packaging Style', $
  FIELD=SIZE, ALIAS=SZ, FORMAT=I2, TITLE='Size',
  DESC='Package Size', $
  FIELD=UNIT_PRICE, ALIAS=UNITPR, FORMAT=D7.2, TITLE='Unit,Price',
  DESC='Price for one unit', $

```

GGPRODS Structure Diagram

```
SECTION 01
  STRUCTURE OF FOCUS      FILE GGPRODS  ON 05/15/03 AT 12.26.05

      GGPRODS
01      S1
*****
*PRODUCT_ID  **I
*PRODUCT_DESC**I
*VENDOR_CODE **
*VENDOR_NAME **
*              **
*****
*****
```

GGSALES Master File

```
FILENAME=GGSALES, SUFFIX=FOC
SEGNAME=SALES01, SEGTYPE=S1
  FIELD=SEQ_NO, ALIAS=SEQ, FORMAT=I5, TITLE='Sequence#',
  DESC='Sequence number in database', $
  FIELD=CATEGORY, ALIAS=E02, FORMAT=A11, INDEX=I, TITLE='Category',
  DESC='Product category', $
  FIELD=PCD, ALIAS=E03, FORMAT=A04, INDEX=I, TITLE='Product ID',
  DESC='Product Identification code (for sale)', $
  FIELD=PRODUCT, ALIAS=E04, FORMAT=A16, TITLE='Product',
  DESC='Product name', $
  FIELD=REGION, ALIAS=E05, FORMAT=A11, INDEX=I, TITLE='Region',
  DESC='Region code', $
  FIELD=ST, ALIAS=E06, FORMAT=A02, INDEX=I, TITLE='State',
  DESC='State', $
  FIELD=CITY, ALIAS=E07, FORMAT=A20, TITLE='City',
  DESC='City', $
  FIELD=STCD, ALIAS=E08, FORMAT=A05, INDEX=I, TITLE='Store ID',
  DESC='Store identification code (for sale)', $
  FIELD=DATE, ALIAS=E09, FORMAT=I8YYMD, TITLE='Date',
  DESC='Date of sales report', $
  FIELD=UNITS, ALIAS=E10, FORMAT=I08, TITLE='Unit Sales',
  DESC='Number of units sold', $
  FIELD=DOLLARS, ALIAS=E11, FORMAT=I08, TITLE='Dollar Sales',
  DESC='Total dollar amount of reported sales', $
```

```

FIELD=BUDUNITS, ALIAS=E12, FORMAT=I08, TITLE='Budget Units',
DESC='Number of units budgeted', $
FIELD=BUDDOLLARS, ALIAS=E13, FORMAT=I08, TITLE='Budget Dollars',
DESC='Total sales quota in dollars', $

```

GGSALES Structure Diagram

```

SECTION 01
    STRUCTURE OF FOCUS    FILE GGSALES    ON 05/15/03 AT 12.26.05

```

```

        GGSALES
01      S1
*****
*SEQ_NO      **
*CATEGORY    **I
*PCD         **I
*PRODUCT     **I
*           **
*****
*****

```

GGSTORES Master File

```

FILENAME=GGSTORES, SUFFIX=FOC
SEGNAME=STORES01, SEGTYPE=S1
FIELD=STORE_CODE, ALIAS=E02, FORMAT=A05, INDEX=I, TITLE='Store ID',
DESC='Franchisee ID Code', $
FIELD=STORE_NAME, ALIAS=E03, FORMAT=A23, TITLE='Store Name',
DESC='Store Name', $
FIELD=ADDRESS1, ALIAS=E04, FORMAT=A19, TITLE='Contact',
DESC='Franchisee Owner', $
FIELD=ADDRESS2, ALIAS=E05, FORMAT=A31, TITLE='Address',
DESC='Street Address', $
FIELD=CITY, ALIAS=E06, FORMAT=A22, TITLE='City',
DESC='City', $
FIELD=STATE, ALIAS=E07, FORMAT=A02, INDEX=I, TITLE='State',
DESC='State', $
FIELD=ZIP, ALIAS=E08, FORMAT=A06, TITLE='Zip Code',
DESC='Postal Code', $

```

GGSTORES Structure Diagram

```
SECTION 01
  STRUCTURE OF FOCUS    FILE GGSTORES ON 05/15/03 AT 12.26.05

      GGSTORES
01      S1
*****
*STORE_CODE  **I
*STORE_NAME  **
*ADDRESS1    **
*ADDRESS2    **
*            **
*****
*****
```

Century Corp Data Sources

Century Corp is a consumer electronics manufacturer that distributes products through retailers around the world. Century Corp has thousands of employees in plants, warehouses, and offices worldwide. Their mission is to provide quality products and services to their customers.

Century Corp is a group of data sources that contain financial, human resources, inventory, and order information. The last three data sources are designed to be used with chart of accounts data.

- CENTCOMP Master File contains location information for stores. It consists of one segment, COMPINFO.
- CENTFIN Master File contains financial information. It consists of one segment, ROOT_SEG.
- CENTHR Master File contains human resources information. It consists of one segment, EMPSEG.
- CENTINV Master File contains inventory information. It consists of one segment, INVINFO.
- CENTORD Master File contains order information. It consists of four segments, OINFO, STOSEG, PINFO, and INVSEG.

- CENTQA Master File contains problem information. It consists of three segments, PROD_SEG, INVSEG, and PROB_SEG.
- CENTGL Master File contains a chart of accounts hierarchy. The field GL_ACCOUNT_PARENT is the parent field in the hierarchy. The field GL_ACCOUNT is the hierarchy field. The field GL_ACCOUNT_CAPTION can be used as the descriptive caption for the hierarchy field.
- CENTSYSF Master File contains detail-level financial data. CENTSYSF uses a different account line system (SYS_ACCOUNT), which can be joined to the SYS_ACCOUNT field in CENTGL. Data uses "natural" signs (expenses are positive, revenue negative).
- CENTSTMT Master File contains detail-level financial data and a cross-reference to the CENTGL data source.

CENTCOMP Master File

```

FILE=CENTCOMP, SUFFIX=FOC, FDFC=19, FYRT=00
  SEGNAME=COMPINFO, SEGTYPE=S1, $
  FIELD=STORE_CODE, ALIAS=SNUM, FORMAT=A6, INDEX=I,
  TITLE='Store Id#:',
  DESCRIPTION='Store Id#', $
  FIELD=STORENAME, ALIAS=SNAME, FORMAT=A20,
  WITHIN=STATE,
  TITLE='Store,Name:',
  DESCRIPTION='Store Name', $
  FIELD=STATE, ALIAS=STATE, FORMAT=A2,
  WITHIN=PLANT,
  TITLE='State:',
  DESCRIPTION=State, $
  DEFINE REGION/A5=DECODE STATE ('AL' 'SOUTH' 'AK' 'WEST' 'AR' 'SOUTH'
  'AZ' 'WEST' 'CA' 'WEST' 'CO' 'WEST' 'CT' 'EAST'
  'DE' 'EAST' 'DC' 'EAST' 'FL' 'SOUTH' 'GA' 'SOUTH' 'HI' 'WEST'
  'ID' 'WEST' 'IL' 'NORTH' 'IN' 'NORTH' 'IA' 'NORTH'
  'KS' 'NORTH' 'KY' 'SOUTH' 'LA' 'SOUTH' 'ME' 'EAST' 'MD' 'EAST'
  'MA' 'EAST' 'MI' 'NORTH' 'MN' 'NORTH' 'MS' 'SOUTH' 'MT' 'WEST'
  'MO' 'SOUTH' 'NE' 'WEST' 'NV' 'WEST' 'NH' 'EAST' 'NJ' 'EAST'
  'NM' 'WEST' 'NY' 'EAST' 'NC' 'SOUTH' 'ND' 'NORTH' 'OH' 'NORTH'
  'OK' 'SOUTH' 'OR' 'WEST' 'PA' 'EAST' 'RI' 'EAST' 'SC' 'SOUTH'
  'SD' 'NORTH' 'TN' 'SOUTH' 'TX' 'SOUTH' 'UT' 'WEST' 'VT' 'EAST'
  'VA' 'SOUTH' 'WA' 'WEST' 'WV' 'SOUTH' 'WI' 'NORTH' 'WY' 'WEST'
  'NA' 'NORTH' 'ON' 'NORTH' ELSE ' ');,

```

```
TITLE='Region:',
DESCRIPTION=Region, $
```

CENTCOMP Structure Diagram

```
SECTION 01
      STRUCTURE OF FOCUS      FILE CENTCOMP ON 05/15/03 AT 10.20.49

      COMPINFO
01      S1
*****
*STORE_CODE  **I
*STORENAME   **
*STATE       **
*            **
*            **
*****
*****
```

CENTFIN Master File

```
FILE=CENTFIN, SUFFIX=FOC, FDFC=19, FYRT=00
SEGNAME=ROOT_SEG, SEGTYPE=S4, $
FIELD=YEAR, ALIAS=YEAR, FORMAT=YY,
  WITHIN='*Time Period', $
FIELD=QUARTER, ALIAS=QTR, FORMAT=Q,
  WITHIN=YEAR,
  TITLE=Quarter,
  DESCRIPTION=Quarter, $
FIELD=MONTH, ALIAS=MONTH, FORMAT=M,
  TITLE=Month,
  DESCRIPTION=Month, $
FIELD=ITEM, ALIAS=ITEM, FORMAT=A20,
  TITLE=Item,
  DESCRIPTION=Item, $
FIELD=VALUE, ALIAS=VALUE, FORMAT=D12.2,
  TITLE=Value,
  DESCRIPTION=Value, $
DEFINE ITYPE/A12=IF EDIT(ITEM,'9$$$$$$$$$$$$$$$$') EQ 'E'
```

```

THEN 'Expense' ELSE IF EDIT(ITEM,'9$$$$$$$$$$$$$$$$') EQ 'R'
THEN 'Revenue' ELSE 'Asset';,
TITLE=Type,
DESCRIPTION='Type of Financial Line Item', $
DEFINE MOTEXT/MT=MONTH;,$

```

CENTFIN Structure Diagram

```

SECTION 01
      STRUCTURE OF FOCUS      FILE CENTFIN      ON 05/15/03 AT 10.25.52

      ROOT_SEG
01      S4
*****
*YEAR          **
*QUARTER       **
*MONTH         **
*ITEM          **
*              **
*****
*****

```

CENTHR Master File

```

FILE=CENTHR, SUFFIX=FOC
SEGNAME=EMPSEG, SEGTYPE=S1, $
FIELD=ID_NUM, ALIAS=ID#, FORMAT=I9,
TITLE='Employee, ID#',
DESCRIPTION='Employee Identification Number', $
FIELD=LNAME, ALIAS=LN, FORMAT=A14,
TITLE='Last, Name',
DESCRIPTION='Employee Last Name', $
FIELD=FNAME, ALIAS=FN, FORMAT=A12,
TITLE='First, Name',
DESCRIPTION='Employee First Name', $
FIELD=PLANT, ALIAS=PLT, FORMAT=A3,
TITLE='Plant, Location',
DESCRIPTION='Location of the manufacturing plant',
WITHIN='*Location', $

```

```

FIELD=START_DATE, ALIAS=SDATE, FORMAT=YYMD,
  TITLE='Starting,Date',
  DESCRIPTION='Date of employment', $
FIELD=TERM_DATE, ALIAS=TERM_DATE, FORMAT=YYMD,
  TITLE='Termination,Date',
  DESCRIPTION='Termination Date', $
FIELD=STATUS, ALIAS=STATUS, FORMAT=A10,
  TITLE='Current,Status',
  DESCRIPTION='Job Status', $
FIELD=POSITION, ALIAS=JOB, FORMAT=A2,
  TITLE=Position,
  DESCRIPTION='Job Position', $
FIELD=PAYSCALE, ALIAS=PAYLEVEL, FORMAT=I2,
  TITLE='Pay,Level',
  DESCRIPTION='Pay Level',
  WITHIN='*Wages', $
DEFINE POSITION_DESC/A17=IF POSITION EQ 'BM' THEN
  'Plant Manager' ELSE
  IF POSITION EQ 'MR' THEN 'Line Worker' ELSE
  IF POSITION EQ 'TM' THEN 'Line Manager' ELSE
  'Technician';
  TITLE='Position,Description',
  DESCRIPTION='Position Description',
  WITHIN='PLANT', $
DEFINE BYEAR/YY=START_DATE;
  TITLE='Beginning,Year',
  DESCRIPTION='Beginning Year',
  WITHIN='*Starting Time Period', $

```

```

DEFINE BQUARTER/Q=START_DATE;
  TITLE='Beginning,Quarter',
  DESCRIPTION='Beginning Quarter',
  WITHIN='BYEAR',
DEFINE BMONTH/M=START_DATE;
  TITLE='Beginning,Month',
  DESCRIPTION='Beginning Month',
  WITHIN='BQUARTER', $
DEFINE EYEAR/YY=TERM_DATE;
  TITLE='Ending,Year',
  DESCRIPTION='Ending Year',
  WITHIN='*Termination Time Period', $
DEFINE EQUARTER/Q=TERM_DATE;
  TITLE='Ending,Quarter',
  DESCRIPTION='Ending Quarter',
  WITHIN='EYEAR', $
DEFINE EMONTH/M=TERM_DATE;

```

```

TITLE='Ending,Month',
DESCRIPTION='Ending Month',
WITHIN='EQUARTER', $
DEFINE RESIGN_COUNT/I3=IF STATUS EQ 'RESIGNED' THEN 1
ELSE 0;
TITLE='Resigned,Count',
DESCRIPTION='Resigned Count', $
DEFINE FIRE_COUNT/I3=IF STATUS EQ 'TERMINAT' THEN 1
ELSE 0;
TITLE='Terminated,Count',
DESCRIPTION='Terminated Count', $
DEFINE DECLINE_COUNT/I3=IF STATUS EQ 'DECLINED' THEN 1
ELSE 0;
TITLE='Declined,Count',
DESCRIPTION='Declined Count', $
DEFINE EMP_COUNT/I3=IF STATUS EQ 'EMPLOYED' THEN 1
ELSE 0;
TITLE='Employed,Count',
DESCRIPTION='Employed Count', $
DEFINE PEND_COUNT/I3=IF STATUS EQ 'PENDING' THEN 1
ELSE 0;
TITLE='Pending,Count',
DESCRIPTION='Pending Count', $
DEFINE REJECT_COUNT/I3=IF STATUS EQ 'REJECTED' THEN 1
ELSE 0;
TITLE='Rejected,Count',
DESCRIPTION='Rejected Count', $
DEFINE FULLNAME/A28=LNAME||', '|FNAME;
TITLE='Full Name',
DESCRIPTION='Full Name: Last, First', WITHIN='POSITION_DESC', $

```

```

DEFINE SALARY/D12.2=IF BMONTH LT 4 THEN PAYLEVEL * 12321
ELSE IF BMONTH GE 4 AND BMONTH LT 8 THEN PAYLEVEL * 13827
ELSE PAYLEVEL * 14400;
TITLE='Salary',
DESCRIPTION='Salary', $
DEFINE PLANTLNG/A11=DECODE PLANT (BOS 'Boston' DAL 'Dallas'
LA 'Los Angeles' ORL 'Orlando' SEA 'Seattle' STL 'St Louis'
ELSE 'n/a'); $

```

CENTHR Structure Diagram

```
SECTION 01
  STRUCTURE OF FOCUS   FILE CENTHR   ON 05/15/03 AT 10.40.34

      EMPSEG
01      S1
*****
*ID_NUM      **
*LNAME       **
*FNAME       **
*PLANT       **
*            **
*****
*****
```

CENTINV Master File

```
FILE=CENTINV, SUFFIX=FOC, FDFC=19, FYRT=00
SEGNAME=INVINFO, SEGTYPE=S1, $
FIELD=PROD_NUM, ALIAS=PNUM, FORMAT=A4, INDEX=I,
  TITLE='Product,Number:',
  DESCRIPTION='Product Number', $
FIELD=PRODNAME, ALIAS=PNAME, FORMAT=A30,
  WITHIN=PRODCAT,
  TITLE='Product,Name:',
  DESCRIPTION='Product Name', $
FIELD=QTY_IN_STOCK, ALIAS=QIS, FORMAT=I7,
  TITLE='Quantity,In Stock:',
  DESCRIPTION='Quantity In Stock', $
FIELD=PRICE, ALIAS=RETAIL, FORMAT=D10.2,
  TITLE='Price:',
  DESCRIPTION=Price, $
FIELD=COST, ALIAS=OUR_COST, FORMAT=D10.2,
  TITLE='Our,Cost:',
  DESCRIPTION='Our Cost:', $
DEFINE PRODCAT/A22 = IF PRODNAME CONTAINS 'LCD'
  THEN 'VCRs' ELSE IF PRODNAME
  CONTAINS 'DVD' THEN 'DVD' ELSE IF PRODNAME CONTAINS 'Camcor'
  THEN 'Camcorders'
  ELSE IF PRODNAME CONTAINS 'Camera' THEN 'Cameras' ELSE IF PRODNAME
  CONTAINS 'CD' THEN 'CD Players'
```

```

ELSE IF PRODNAM CONTAINS 'Tape' THEN 'Digital Tape Recorders'
ELSE IF PRODNAM CONTAINS 'Combo' THEN 'Combo Players'
ELSE 'PDA Devices'; WITHIN=PRODTYPE, TITLE='Product Category:', $
DEFINE PRODTYPE/A19 = IF PRODNAM CONTAINS 'Digital' OR 'DVD' OR 'QX'
THEN 'Digital' ELSE 'Analog';, WITHIN='*Product Dimension',
TITLE='Product Type:', $

```

CENTINV Structure Diagram

SECTION 01

STRUCTURE OF FOCUS FILE CENTINV ON 05/15/03 AT 10.43.35

```

          INVINFO
01          S1
*****
*PROD_NUM   **I
*PRODNAM    **
*QTY_IN_STOCK**
*PRICE      **
*           **
*****
*****

```

CENTORD Master File

```

FILE=CENTORD, SUFFIX=FOC
SEGNAME=OINFO, SEGTYPE=S1, $
FIELD=ORDER_NUM, ALIAS=ONUM, FORMAT=A5, INDEX=I,
TITLE='Order,Number:',
DESCRIPTION='Order Number', $
FIELD=ORDER_DATE, ALIAS=ODATE, FORMAT=YYMD,
TITLE='Date,Of Order:',
DESCRIPTION='Date Of Order', $
FIELD=STORE_CODE, ALIAS=SNUM, FORMAT=A6, INDEX=I,
TITLE='Company ID#:',
DESCRIPTION='Company ID#', $
FIELD=PLANT, ALIAS=PLNT, FORMAT=A3, INDEX=I,
TITLE='Manufacturing,Plant',
DESCRIPTION='Location Of Manufacturing Plant',

```

```

    WITHIN='*Location', $
    DEFINE YEAR/YY=ORDER_DATE;,
    WITHIN='*Time Period', $
    DEFINE QUARTER/Q=ORDER_DATE;,
    WITHIN='YEAR', $
    DEFINE MONTH/M=ORDER_DATE;,
    WITHIN='QUARTER', $
    SEGNAME=PINFO, SEGTYPE=S1, PARENT=OINFO, $
    FIELD=PROD_NUM, ALIAS=PNUM, FORMAT=A4, INDEX=I,
    TITLE='Product, Number#:',
    DESCRIPTION='Product Number#', $
    FIELD=QUANTITY, ALIAS=QTY, FORMAT=I8C,
    TITLE='Quantity:',
    DESCRIPTION=Quantity, $
    FIELD=LINEPRICE, ALIAS=LINETOTAL, FORMAT=D12.2MC,
    TITLE='Line, Total',
    DESCRIPTION='Line Total', $
    DEFINE LINE_COGS/D12.2=QUANTITY*COST;,
    TITLE='Line, Cost Of, Goods Sold',
    DESCRIPTION='Line cost of goods sold', $
    DEFINE PLANTLNG/A11=DECODE PLANT (BOS 'Boston' DAL 'Dallas'
    LA 'Los Angeles' ORL 'Orlando' SEA 'Seattle' STL 'St Louis'
    ELSE 'n/a');
    SEGNAME=INVSEG, SEGTYPE=DKU, PARENT=PINFO, CRFILE=CENTINV,
    CRKEY=PROD_NUM, CRSEG=INVINFO, $
    SEGNAME=STOSEG, SEGTYPE=DKU, PARENT=OINFO, CRFILE=CENTCOMP,
    CRKEY=STORE_CODE, CRSEG=COMPINFO, $

```

CENTORD Structure Diagram

SECTION 01

STRUCTURE OF FOCUS FILE CENTORD ON 05/15/03 AT 10.17.52

```

    OINFO
    01    S1
    *****
    *ORDER_NUM    **I
    *STORE_CODE   **I
    *PLANT        **I
    *ORDER_DATE   **
    *             **
    *****
    *****

```

```

      I
      +-----+
      I          I
      I STOSEG    I PINFO
02   I KU        03   I S1
.....          *****
:STORE_CODE  :K  *PROD_NUM   **I
:STORENAME   :   *QUANTITY   **
:STATE       :   *LINEPRICE  **
:           :   *           **
:           :   *           **
:.....:   *****
JOINED  CENTCOMP *****
          I
          I
          I
          I INVSEG
          04   I KU
          .....
          :PROD_NUM   :K
          :PRODNAME   :
          :QTY_IN_STOCK:
          :PRICE      :
          :           :
          :.....:
          JOINED  CENTINV

```

CENTQA Master File

```

FILE=CENTQA, SUFFIX=FOC, FDFC=19, FYRT=00
SEGNAME=PROD_SEG, SEGTYPE=S1, $
  FIELD=PROD_NUM, ALIAS=PNUM, FORMAT=A4, INDEX=I,
  TITLE='Product,Number',
  DESCRIPTION='Product Number', $
SEGNAME=PROB_SEG, PARENT=PROD_SEG, SEGTYPE=S1, $
  FIELD=PROBNUM, ALIAS=PROBNO, FORMAT=I5,
  TITLE='Problem,Number',
  DESCRIPTION='Problem Number',
  WITHIN=PLANT,$
  FIELD=PLANT, ALIAS=PLT, FORMAT=A3, INDEX=I,
  TITLE=Plant,
  DESCRIPTION=Plant,
  WITHIN=PROBLEM_LOCATION,$

```

```

FIELD=PROBLEM_DATE, ALIAS=PDATE, FORMAT=YYMD,
  TITLE='Date,Problem,Reported',
  DESCRIPTION='Date Problem Was Reported', $
FIELD=PROBLEM_CATEGORY, ALIAS=PROBCAT, FORMAT=A20, $
  TITLE='Problem,Category',
  DESCRIPTION='Problem Category',
  WITHIN=*Problem,$
FIELD=PROBLEM_LOCATION, ALIAS=PROBLOC, FORMAT=A10,
  TITLE='Location,Problem,Occurred',
  DESCRIPTION='Location Where Problem Occurred',
  WITHIN=PROBLEM_CATEGORY,$
DEFINE PROB_YEAR/YY=PROBLEM_DATE;,
  TITLE='Year,Problem,Occurred',
  DESCRIPTION='Year Problem Occurred',
  WITHIN=*Time Period,$
DEFINE PROB_QUARTER/Q=PROBLEM_DATE;
  TITLE='Quarter,Problem,Occurred',
  DESCRIPTION='Quarter Problem Occurred',
  WITHIN=PROB_YEAR,$
DEFINE PROB_MONTH/M=PROBLEM_DATE;
  TITLE='Month,Problem,Occurred',
  DESCRIPTION='Month Problem Occurred',
  WITHIN=PROB_QUARTER,$
DEFINE PROBLEM_OCCUR/I5 WITH PROBNUM=1;,
  TITLE='Problem,Occurrence'
  DESCRIPTION='# of times a problem occurs',$
DEFINE PLANTLNG/A11=DECODE PLANT (BOS 'Boston' DAL 'Dallas'
  LA 'Los Angeles' ORL 'Orlando' SEA 'Seattle' STL 'St Louis'
  ELSE 'n/a');$
SEGNAME=INVSEG, SEGTYPE=DKU, PARENT=PROD_SEG, CRFILE=CENTINV,
  CRKEY=PROD_NUM, CRSEG=INVINFO,$

```

CENTQA Structure Diagram

SECTION 01

STRUCTURE OF FOCUS

FILE CENTQA

ON 05/15/03 AT 10.46.43

PROD_SEG

01 S1

*PROD_NUM **I

* **

* **

```

*           **
*           **
*****
*****
      I
      +-----+
      I           I
      I INVSEG      I PROB_SEG
02   I KU          03   I S1
.....          *****
:PROD_NUM      :K  *PROBNUM      **
:PRODNAME      :  *PLANT        **I
:QTY_IN_STOCK:  *PROBLEM_DATE**
:PRICE         :  *PROBLEM_CAT>**
:              :  *           **
:.....:      *****
JOINED CENTINV *****

```

CENTGL Master File

```

FILE=CENTGL ,SUFFIX=FOC
SEGNAME=ACCOUNTS, SEGTYPE=S1
FIELDNAME=GL_ACCOUNT, ALIAS=GLACCT, FORMAT=A7,
  TITLE='Ledger,Account', FIELDTYPE=I, $
FIELDNAME=GL_ACCOUNT_PARENT, ALIAS=GLPAR, FORMAT=A7,
  TITLE=Parent,
  PROPERTY=PARENT_OF, REFERENCE=GL_ACCOUNT, $
FIELDNAME=GL_ACCOUNT_TYPE, ALIAS=GLTYPE, FORMAT=A1,
  TITLE=Type,$
FIELDNAME=GL_ROLLUP_OP, ALIAS=GLROLL, FORMAT=A1,
  TITLE=Op, $
FIELDNAME=GL_ACCOUNT_LEVEL, ALIAS=GLLEVEL, FORMAT=I3,
  TITLE=Lev, $
FIELDNAME=GL_ACCOUNT_CAPTION, ALIAS=GLCAP, FORMAT=A30,
  TITLE=Caption,
  PROPERTY=CAPTION, REFERENCE=GL_ACCOUNT, $
FIELDNAME=SYS_ACCOUNT, ALIAS=ALINE, FORMAT=A6,
  TITLE='System,Account,Line', MISSING=ON, $

```

CENTGL Structure Diagram

```
SECTION 01
      STRUCTURE OF FOCUS      FILE CENTGL      ON 05/15/03 AT 15.18.48

      ACCOUNTS
01      S1
*****
*GL_ACCOUNT  **I
*GL_ACCOUNT_>**
*GL_ACCOUNT_>**
*GL_ROLLUP_OP**
*          **
*****
*****
```

CENTSYSF Master File

```
FILE=CENTSYSF ,SUFFIX=FOC
SEGNAME=RAWDATA ,SEGTYPE=S2
  FIELDNAME = SYS_ACCOUNT , ,A6 , FIELDTYPE=I,
  TITLE='System,Account,Line', $
  FIELDNAME = PERIOD , ,YYM , FIELDTYPE=I,$
  FIELDNAME = NAT_AMOUNT , ,D10.0 , TITLE='Month,Actual', $
  FIELDNAME = NAT_BUDGET , ,D10.0 , TITLE='Month,Budget', $
  FIELDNAME = NAT_YTDAMT , ,D12.0 , TITLE='YTD,Actual', $
  FIELDNAME = NAT_YTDBUD , ,D12.0 , TITLE='YTD,Budget', $
```

CENTSYSF Structure Diagram

```
SECTION 01
      STRUCTURE OF FOCUS      FILE CENTSYSF      ON 05/15/03 AT 15.19.27

      RAWDATA
01      S2
*****
*SYS_ACCOUNT **I
*PERIOD      **I
```

```

*NAT_AMOUNT **
*NAT_BUDGET **
* **
*****
*****

```

CENTSTMT Master File

```

FILE=CENTSTMT, SUFFIX=FOC
SEGNAME=ACCOUNTS, SEGTYPE=S1
  FIELD=GL_ACCOUNT, ALIAS=GLACCT, FORMAT=A7,
  TITLE='Ledger,Account', FIELDTYPE=I, $
  FIELD=GL_ACCOUNT_PARENT, ALIAS=GLPAR, FORMAT=A7,
  TITLE=Parent,
  PROPERTY=PARENT_OF, REFERENCE=GL_ACCOUNT, $
  FIELD=GL_ACCOUNT_TYPE, ALIAS=GLTYPE, FORMAT=A1,
  TITLE=Type,$
  FIELD=GL_ROLLUP_OP, ALIAS=GLROLL, FORMAT=A1,
  TITLE=Op, $
  FIELD=GL_ACCOUNT_LEVEL, ALIAS=GLLEVEL, FORMAT=I3,
  TITLE=Lev, $
  FIELD=GL_ACCOUNT_CAPTION, ALIAS=GLCAP, FORMAT=A30,
  TITLE=Caption,
  PROPERTY=CAPTION, REFERENCE=GL_ACCOUNT, $
SEGNAME=CONSOL, SEGTYPE=S1, PARENT=ACCOUNTS, $
  FIELD=PERIOD, ALIAS=MONTH, FORMAT=YYM, $
  FIELD=ACTUAL_AMT, ALIAS=AA, FORMAT=D10.0, MISSING=ON,
  TITLE='Actual', $
  FIELD=BUDGET_AMT, ALIAS=BA, FORMAT=D10.0, MISSING=ON,
  TITLE='Budget', $
  FIELD=ACTUAL_YTD, ALIAS=AYTD, FORMAT=D12.0, MISSING=ON,
  TITLE='YTD,Actual', $
  FIELD=BUDGET_YTD, ALIAS=BYTD, FORMAT=D12.0, MISSING=ON,
  TITLE='YTD,Budget', $

```

CENTSTMT Structure Diagram

```

SECTION 01
  STRUCTURE OF FOCUS      FILE CENTSTMT ON 05/15/03 AT 14.45.44

```



```

          ACCOUNTS
01      S1
*****
*GL_ACCOUNT  **I
*GL_ACCOUNT_>**
*GL_ACCOUNT_>**
*GL_ROLLUP_OP**
*           **
*****
*****
          I
          I
          I
          I CONSOL
02      I S1
*****
*PERIOD      **
*ACTUAL_AMT  **
*BUDGET_AMT  **
*ACTUAL_YTD  **
*           **
*****
*****

```

CENTGLL Master File

```

FILE=CENTGLL      ,SUFFIX=FOC
SEGNAME=ACCOUNTS ,SEGTYPE=S01
FIELDNAME=GL_ACCOUNT,      ALIAS=GLACCT,  FORMAT=A7,
                          TITLE='Ledger,Account', FIELDTYPE=I, $
FIELDNAME=GL_ACCOUNT_PARENT, ALIAS=GLPAR,  FORMAT=A7,
                          TITLE=Parent,
                          PROPERTY=PARENT_OF, REFERENCE=GL_ACCOUNT, $
FIELDNAME=GL_ACCOUNT_TYPE,  ALIAS=GLTYPE,  FORMAT=A1,
                          TITLE=Type,$
FIELDNAME=GL_ROLLUP_OP,     ALIAS=GLROLL,  FORMAT=A1,
                          TITLE=Op, $
FIELDNAME=GL_ACCOUNT_LEVEL, ALIAS=GLLEVEL,  FORMAT=I3,
                          TITLE=Lev, $
FIELDNAME=GL_ACCOUNT_CAPTION, ALIAS=GLCAP,  FORMAT=A30,
                          TITLE=Caption,
                          PROPERTY=CAPTION, REFERENCE=GL_ACCOUNT, $

```

```
FIELDNAME=SYS_ACCOUNT,          ALIAS=ALINE,  FORMAT=A6,  
TITLE='System,Account,Line', MISSING=ON, $
```

CENTGLL Structure Diagram

```
SECTION 01  
STRUCTURE OF FOCUS      FILE CENTGLL ON 05/15/03 AT 14.45.44  
  
      ACCOUNTS  
01      S1  
*****  
*GL_ACCOUNT  **I  
*GL_ACCOUNT_>**  
*GL_ACCOUNT_>**  
*GL_ROLLUP_OP**  
*           **  
*****  
*****
```

Error Messages

To see the text or explanation for any error message, you can display it online in your FOCUS session or find it in a standard FOCUS ERRORS file. All of the FOCUS error messages are stored in eight system ERRORS files.

- For z/OS, the ddname is ERRORS.

Accessing Error Files

For z/OS, the error files are the following members in the ERRORS PDS:

- FOT004
- FOG004
- FOM004
- FOS004
- FOA004
- FSQLXLT
- FOCSTY
- FOB004

Displaying Messages

To display the text and explanation for any message, issue the following query command at the FOCUS command level

```
? n
```

where:

n

Is the message number.

The message number and text appear, along with a detailed explanation of the message (if one exists). For example, issuing the following command

```
? 210
```

displays the following:

```
(FOC210)          THE DATA VALUE HAS A FORMAT ERROR:  
An alphabetic character has been found where all numerical digits are  
required.
```

User Exits for a Non-FOCUS Data Source

This appendix describes three ways to read non-FOCUS data sources with user-written procedures.

Dynamic and Re-Entrant Private User Exit of the FOCSAM Interface

The FOCSAM Interface contains a user exit that can be invoked as an alternative to the lowest-level retrieval routines that are part of the interface. This exit makes it possible to combine user-written code, devoid of any dependence on internal structures, with the logical retrieval functions of the FOCSAM Interface, such as record selection logic, treatment of missing records in multi-record files, JOINS between various types of files, etc. The major features of the GETPRV exit are as follows:

- Through the CONTEXT parameter, the exit supports reentrancy, providing the benefit of reduced storage requirements as well as enhanced invocation performance.
- Support for multiple concurrent exit processors is provided through an Access File where a user exit module can be named on a per Master File basis.
- The user exit is dynamically called at execution time, avoiding the need to modify FOCUS after each upgrade or application of maintenance. There is no need for link-edits to FOCUS.
- An initialization call allows the exit code to perform initial housekeeping.
- The QUALIF parameter supports the options (O) OPEN file, (R) OPEN request (position), (C) CLOSE, and (F) FIN of FOCUS. These control options are in addition to the (S), (G), and (E) read options.
- The exit supports multiple positions on the same file.

Functional Requirements

Functionally, the private code is a substitute for retrieval calls typically used against, but not limited to, key-sequenced VSAM data sources and can be used against any data source that can be represented as such a file. The private code need not deal with any intra-record structures represented by OCCURS clauses, nor with the translation of FOCUS IF conditions into lower-level criteria. Both of these functions are performed by the driving logic in the FOCUSAM Interface.

The user-written code must conform to following:

1. Must be able to obtain a record, given a full value of the key. The key is presumed to be unique (direct read).
2. Must be able to obtain a record greater than or equal to a given value of the full or partial key (generic read).
3. Must be able to obtain the next logical record, starting from the current position in the file (sequential read). Successive sequential reads must return records in ascending sequence (bit by bit) on the key field.
4. Direct and generic reads that retrieve records must establish the starting position in the file for subsequent sequential reads. Direct reads that fail to retrieve the requested records need not establish these positions.
5. For the open file request (O), it must logically or physically open the file.
6. If the logical end-of-file is reached as a result of a sequential read, an end-of-file signal must be returned. Subsequent sequential reads must return end-of-file signals rather than error indications, for example, when processing a JOIN.
7. A 'close' function must be provided that results in the release of all resources and loss of position in the file, so that subsequent open requests succeed.
8. Successive close calls must be innocuous. Be prepared to close a file that is already closed.
9. A unique area must be obtained, for example, GETMAIN, and maintained using the CONTEXT parameter on a per DDNAME basis.
10. The code must be serially reusable and re-entrant. It must be linked AMODE 31.

Implementation

The Dynamic GETPRV exit is linked as a separate module and loaded or called from FOCUS.

Master File

The Master File for data to be accessed using this user exit is the same as the description of any other data source read by the FOCSAM Interface except that the SUFFIX must specify PRIVATE and a GROUP with ALIAS=KEY must be specified. All other READ ONLY features of the FOCSAM Interface are fully supported. For example,

```
FILE=filename, SUFFIX=PRIVATE,$
SEGNAME=ROOT, SEGTYPE=S0,$
GROUP=keyname , ALIAS=KEY , USAGE=xx, ACTUAL=xx , $
FIELD=fieldname1, ALIAS=aliasname1, USAGE=xx, ACTUAL=xx , $
FIELD=fieldname2, ALIAS=aliasname2, USAGE=xx, ACTUAL=xx , $
```

i Note: SUFFIX=PRIVATE. No other options will invoke the exit.

Access File

An Access File is required and provides a pointer to the actual name of the private exit. The PDS used for the Access File must be allocated to DDNAME ACCESS.

For example,

```
MODNAME=pgmname, $
```

To allocate this Access File, enter:

```
//ACCESS DD DSN=access.file.pds.name,DISP=SHR
```

Calling Sequence

The user-coded retrieval routine is written as a standalone program. There are no limitations to the program name other than standard IBM rules. It is recommended that the program be written in a language that fully supports reentrancy, such as ASSEMBLER or C. The parameter list is as follows:

NCHAR

Full-word binary integer, posted by the exit. A positive number indicates the length in bytes of the record obtained; zero indicates no record or end-of-file (there is no difference). Must be non-zero for every successful read. Used by read options (S), (E), and (G).

DDNAME

Eight-byte character argument, posted by FOCSAM, corresponding to the FOCUS file name for the generated report. For example, TABLE FILE CAR results in DDNAME CAR, left-justified and blank-padded. Used for all options except (F). Do not modify this parameter.

ABUFF

Full-word binary integer, posted by the exit; the absolute address of the record obtained by this call. Used with all read options (S), (E), and (G). Do not modify this pointer. Instead, modify the location addressed by the pointer.

RC

Full-word binary integer return code, posted by the exit. Zero indicates no error: non-zero indicates some type of error. Used with all options.

KEY

Full-word binary integer posted by FOCSAM, containing the full value of the key for direct or generic reads. Not significant for sequential reads. The key value is left justified and less than 255 bytes long.

Note that the exit must know the exact key length and its format. Used with options (E) and (G). Do not modify this parameter.

OPT

Four-byte character argument, posted by FOCSAM, indicating the type of call. Do not modify this parameter. The options are as follows:

READ OPTIONS

'S ' = sequential read.

'E ' = direct read (EQ).

'G ' = generic read (GE).

CONTROL OPTIONS

'O ' = OPEN file.

'R ' = OPEN request (position) used for recursive JOINS.

'C ' = CLOSE file.

'F ' = FIN for FOCUS—final housekeeping should be done here.

These control and read arguments must include three trailing blanks.

CONTEXT

Full-word binary integer, posted by FOCSAM, which points to a work area described below. Do not modify this parameter.

i Note: The parameters passed to the exit are not delimited by having the high-order bit set on in the last parameter. Make sure that your program does not scan for this high-order bit.

Work Area Control Block

The parameter list for the work area control block is:

EYECATCH

An eight- character string containing the literal 'PRIVATE '.

PFMCB

Full-word binary integer, posted by the exit. Generally set during option (O) processing by the exit program and returned unchanged by subsequent FOCSAM calls. This parameter is generally used to point to the dynamic work areas used to maintain reentrancy.

PFACB

Full-word binary integer, posted by the exit. Generally set during option (O) processing by the exit program and returned unchanged by subsequent FOCSAM calls for options (C), (R), (E), (G), and (S) and is unique by DDNAME. This is generally used as a physical file context. This parameter is not valid for option (F).

PFRPL

Full-word binary integer, posted by the exit. Generally set during option (R) processing by the exit program and returned unchanged by subsequent FOCSAM calls for options (E), (G), and (S) and is unique for each view within the above PFACB parameter. This is generally used for logical file context.

This parameter is not valid for option (F).

KEYLENF

Full-word binary integer, posted by the exit. Generally set during option (O) processing by the exit program and should contain the whole key length for the file.

KEYLENR

Full-word binary integer, posted by the exit. Generally set during options (G) and (E) processing by the exit program and should contain the actual key length for a direct read.

ERRTEXT

Full-word binary integer, posted by the exit. Should contain the absolute starting address of a message. FOCUS displays this message if the RC parameter returned by the exit is non-zero and for options (E), (G), and (S).

ERRTEXTL

Full-word binary integer, posted by the exit. It should contain the length of the above ERRTEXT message.

INDEX

Full-word binary integer, posted by FOCSAM.

This option contains the index # by which to access the file.

0 Primary key in Master File in Master -- KEY-DKEY.

1,2,e Secondary indexes in the Master File.

tc KEY1-DKEY1 or KEY2-DKEY2, and so on, and INDEX=I.

RESERVE1

Full-word binary integer, reserved for future use.

USERID

Full-word binary integer, posted by FOCSAM. This user ID will only be present if found in the central site security environment.

RESERVE2

Full-word binary integer, reserved for future use.

Sample Assembler DSECT

```

GETPRVPL DS    0F
NCHAR@   DS    A
DDN@     DS    A
ABUF@    DS    A
RC@      DS    A
KEY@     DS    A
OPT@     DS    A
CONTEXT@ DS    A
          TITLE 'GETPRV CONTEXT'
CONTEXTD DSECT
EYE      DS    CL8   eye catcher literal
PFMCB@   DS    A     handle
PFACB@   DS    A     file open handle
PFRPL@   DS    A     file retrieval handle
KEYLEN_F DS    F     key length for file
KEYLEN_R DS    F     key length for this request
RETTEXT@ DS    A     pointer to returned message
LRETTEXT DS    F     length of returned message
INDEX    DS    F     index for file access - 0 primary  1... secondary
          DS    A     reserved
USERID   DS    CL8
          DS    2F   reserved
          SPACE 1

```

Sample C Declaration Required For Invoking FFUN Function

```

/*
control block for additional info
*/
typedef struct getprv_inf_s {
char          eye[8];      /* I: eye catcher "PRIVATE "*/
Pvoid         pfmcb;      /* o: p' to handle forgetprv */
                /* set up by user at first option 0 */
                /* I: p' to handle for getprv */
                /* passed to user by all other calls*/
Pvoid         pfacb;      /* o: p' to handle for file */
                /* set up by user at option 0 */
                /* i: p' to handle for file */
                /* passed to user at option C,R,E,G,S */
Pvoid         pfrpl;      /* o: p' to handle for request */
                /* set up by user at option R */
                /* i: p' to handle for request */
                /* passed to user at option E,G,S */
long          keylen_fil; /* I: key length (whole) for the file. */
                /* used at option 0. */
long          keylen_req; /* I: key length for the direct read request*/
                /* used at direct read options G,E */
char          *rettext;   /* O: a'native db error msg text */
long          lrettext;   /* O: l'native db error msg text */
long          index;      /* I:index # by which to access file :
                        = 0 - primary key
                        in master - KEY|DKEY
                        = 1,2,... - secondary indexes
                        in master - KEY1|DKEY1 or KEY2|DKEY2
...
                                and INDEX=I */
long          res1[1];    /* reserved */
char          userid[8];  /* user id */
long          res2[2];    /* reserved */
} getprv_inf_t;
/*
*/

```

```

typedef void FFUN getprv_t (
  long      *nchar      /* out: length of data record read. =0 */
                    /* if eof or no rec found */
                    /* used in all read options S,E,G */
, char      *ddn        /* in : ddname to read */
                    /* used in all options except F */
, char      **abuf      /* out: a' buffer */
                    /* used in all read options S,E,G */
, long      *rc         /* out" return code. = 0 if ok */
                    /* used in all options */
, char      *key       /* in: key value for read */
                    /* used in read options E,G */
, char      *opt       /* in: read option : */
                    /* S sequential read */
                    /* G GE read */
                    /* E EQ read */
                    /* control options */
                    /* O open file */
                    /* R open request (position)*/
                    /* C close file */
                    /* F fin of focus */
, getprv_inf_t *      /* in/out other info. see above */
);
#endif

```

User-coded Data Access Modules

A user routine may be written to provide records to the FOCUS report writer from any non-standard data source that cannot be directly described to FOCUS using the Master File. The record, which can come from any data source, is treated by FOCUS exactly as if it had come from a FOCUS data source. The user routine must be coded as a subroutine in FORTRAN, COBOL, BAL, or PL/I, and must pass data to the FOCUS calling program through arguments in the subroutine.

The user program is loaded automatically by the report writer and is identified by the file suffix, in the Master File. For example, if the Master File contains:

```
FILE = ABC, SUFFIX = MYREAD
```

FOCUS will load and call the program named MYREAD to obtain data whenever there is a TABLE, TABLEF, MATCH, or GRAPH command against file ABC.

The record returned to FOCUS must correspond to a segment instance in the Master File. The layout of the fields in this record corresponds to the ACTUAL formats specified in the Master File for each segment.

It is the responsibility of the user program to determine which segment to pass to FOCUS if the Master File contains more than one segment. FOCUS will traverse the hierarchy in a top-to-bottom, left-to-right sequence. If the user routine can anticipate which segment FOCUS expects to be given, the number of rejected segments will decrease and the retrieval efficiency will increase.

In FORTRAN, the subroutine MYREAD would be coded as follows :

```
SUBROUTINE MYREAD (LCHAR, BUF, OFFSET, RECTYP, NERRX, CSEG, REGI, NFIND,
MATCH, IGNOR, NUMFLD, NUMLEV, CVT)
```

where:

LCHAR

(Four byte integer) If LCHAR > 0, LCHAR is the number of characters in the record passed back to FOCUS. If LCHAR = 0, the user routine is telling FOCUS that an end-of-file has been encountered and the retrieval is complete. If LCHAR = -N, the user routine is telling FOCUS that the buffer contains an error message of length N, to be printed out, and that the user routine should not be called again. LCHAR = -1 is reserved for Information Builders' use.

BUF

This parameter is a 4096 byte buffer provided by FOCUS to receive the record from the user routine.

OFFSET

(Four byte integer) If the user routine puts data in BUF, OFFSET should be set to 0 each time the user routine is called. If the user routine provides its own buffer or buffers, OFFSET is the address of the user's buffer minus the address of BUF. A utility called IADDR is provided to compute an address. In FORTRAN, for example, one could code:

```
OFFSET = IADDR (MYBUF) - IADDR (BUF)
```

RECTYP

(Four byte integer) The number of the FOCUS segment corresponding to the record being presented to FOCUS, set by the routine. These numbers correspond to either the list obtained by issuing '? FILE filename' or the field SEGNO resulting from a CHECK FILE filename HOLD.

NERRX

(Four byte integer) Flag set by FOCUS. If NERRX < 0, FOCUS is directing the user routine to shut down (for example, close all files) and not provide any more records. On return, FOCUS will not call the subroutine again.

CSEG REGI NFIND MATCH

Reserved for Information Builders' use.

IGNOR

(Four byte integer) FOCUS will reject any segment whose number (see RECTYP) is greater than or equal to IGNOR. IGNOR is set by FOCUS, based on the segments referenced in the request, but may be reset by the user routine.

NUMFLD NUMLEV

Reserved for Information Builders. Use CVT.

The MYREAD object code, and any other routine that it calls, must be link-edited into a load module whose member name in the load library is MYREAD. This load library can be allocated as ddname USERLIB or concatenated with the STEPLIB program library.

Re-Entrant VSAM Compression Exit: ZCOMP1

This re-entrant ZCOMP1 exit works with compressed VSAM and sequential files. It requires an initial call to ZCOMP0 for initial housekeeping and a USERWD parameter to anchor storage.

The ZCOMP1 user exit was designed to provide an exit that can be user-supplied in order to decrypt coded fields, expand compressed records, and accomplish any other type of user-specific data manipulation required. This exit is designed to access all files readable by the FOCSAM Interface. It is the user's responsibility to write and maintain this exit.

There are no special Master File requirements. SUFFIX can equal VSAM (for KSDS or ESDS files), FIX (for sequential files), or PRIVATE (for file access through the GETPRV user exit).

Linking ZCOMP1

After you write a ZCOMP1 user exit, it must be linked with VVSET. This process of linking ZCOMP1 into VVSET can be accomplished by using the GENFSAM JCL that is found in the FOCCTL.DATA data set. Note that GENFSAM is designed to link in both ZCOMP1 and GETPRV user exits at the same time. Should you only be implementing one of them, the appropriate lines in the GENFSAM member must be commented out (these would be the INCLUDE OBJECT statements). ZCOMP1 can be linked re-entrant if you plan to use the USERWD parameter.

What Happens When You Use ZCOMP1

The FOCSAM Interface reads the record for the allocated data source. Upon a successful read, FOCSAM calls ZCOMP1, if it exists, with the parameters listed below so that initial housekeeping can be performed. All subsequent calls are to ZCOMP1 with the same parameter list.

The ZCOMP1 exit is responsible for determining what to do with the parameter information it receives. The DDNAME can be used to determine whether the associated data source needs to be decompressed or not. If not, the user exit typically moves A(IRECLEN) to A(ORECLEN) and A(A(IREC)) to A(A(OREC)) and returns to FOCSAM with a zero A(STATCODE). If decompression or any other processing is required, it is the responsibility of the user exit to do so.

After the user exit has completed its processing, it should return with either the A(ORECLEN), A(A(OREC)) and a zero status code or with a non-zero status code which gives the following message:

```
(FOC1150) ZCOMP DECOMPRESS ERROR: status
```

 **Note:** This error terminates a TABLE request.

ZCOMP1 Parameter List

Parameter	Description	Length
A(STATCODE)*	Pointer to fullword binary status code	4 byte integer
A(DDNAME)	Pointer to 8 byte file name in use	8 byte character
A(USERID)	Reserved for future use	8 byte character
A(IRECLN)	Pointer to length of original record	4 byte integer
A(A(IREC))	Pointer to pointer to original record	4 byte integer
A(ORECLN)*	Pointer to length of revised record	4 byte integer
A(A(OREC))*	Pointer to pointer to revised record	4 byte integer
A(USERWD)**	Pointer to fullword	4 byte integer

* The user supplies these parameters.

** This parameter can be used to anchor user storage for re-entrant processing.



Note: Never modify the primary pointers, but rather the pointers or values to which they point.

Note that upon entry to ZCOMP1, the ORECLN and OREC parameters are NULL. It is the responsibility of the user to fill these in correctly.

While processing the FOCUS FIN command, a call is placed to the ZCOMP2 entry point, which provides the user with the ability to do any other global cleanup required.

The parameters returned by ZCOMP1 are not validated. It is the responsibility of the user routine to ensure that valid addresses and lengths are returned to FOCUS from ZCOMP1.

Unpredictable results occur if incorrect parameters are passed back from the routine.

Rounding in FOCUS

This appendix describes how FOCUS numeric fields store and display data, how rounding occurs in calculations, and what happens in conversion from one format to another.

Data Storage and Display

Values are rounded before storage or before display, depending on the format. Integer fields (format I) and packed decimal fields (format P) are rounded before being stored. Floating-point fields (formats F and D) are stored as entered and rounded for display.

In general, when a final decimal digit is less than 5, the data value rounds down. A data value with a final digit of 5 or greater rounds up. The following rounding algorithm is used:

1. The incoming value is multiplied by 10.
2. This multiplication repeats the same number of times as the number of decimal places in the target format. For example, if 123.78 is input to a packed decimal field with one decimal place, it is multiplied by 10 once:

```
1237.8
```

3. Next, 0.5 is added if the incoming value is positive or subtracted if the incoming value is negative:

```
1237.8 + 0.5 = 1238.3
```

or, if the input value was -123.78,

```
-1237.8 - 0.5 = -1238.3
```

4. The value is truncated, and the decimal is shifted to the left.

```
123.8
```

or, if the original value was negative,

-123.8

The following chart illustrates the rounding differences between FOCUS numeric field formats. Subsequent topics discuss these differences in detail.

Format	Type	Format	Input	Stored	Display
I	Integer	I3	123.78	0124	124
F	Floating-Point Single- Precision	F5.1	123.78	123.7800	124
		F3	123.78	123.7800	123.8
D	Floating-Point Double- Precision	D3	123.78	123.780000000000	124
		D5.1	123.78	123.780000000000	123.8
P	Packed	P3	123.78	0000124	124
		P5.1	123.78	00001238	123.8

i Note: For floating-point fields (format D or F), the stored values of decimal numbers are in hexadecimal and may convert to a value very slightly less than the actual decimal number. When the final digit is 5, these numbers may round down instead of up.

Integer Fields: Format I

An integer value entered with no decimal places is stored as entered.

When a value with decimal places is entered into an integer field using a transaction, that value is rounded, and the result is stored. If the fractional portion of the value is less than 0.5, the value is rounded down; if the fractional portion of the value is greater than or equal to 0.5, the value is rounded up. For example, if a value entered in a CRTFORM is 123.78, the value stored is 124.

However, if an integer field is computed, the decimal portion of the resulting value is truncated, and the integer portion of the answer is stored (or printed). For example, if the result of a calculation is 123.78, the value stored is 123.

Floating-Point Fields: Formats F and D

Format type F describes single-precision floating-point numbers stored internally in 4 bytes. Format F is comparable to COBOL COMP-1. Format type D describes double-precision floating-point numbers stored internally in 8 bytes. Format D is comparable to COBOL COMP-2.

Formats F and D store as many decimal places as are input, up to the limit of the field's storage. Floating-point fields are stored in a logarithmic format. The first byte stores the exponent; the remaining 3 or 7 bytes store the mantissa, or value.

When the number of decimal places input is greater than the number of decimal places specified in the format, F and D field values are stored as they are input, up to the limit of precision. These values are rounded for display according to the field format. For example, if 123.78 is entered in a floating-point field with one decimal place, 123.78 is stored, and 123.8 is displayed.

Format D is more accurate than format F for larger numbers, since D fields can store up to 15 significant digits, and F fields are not accurate beyond 8 digits.

Packed Decimal Format: Format P

In packed-decimal format (format type P), each byte contains two digits, except the last byte, which contains a digit and the sign (D for negative numbers, C for positive). Packed fields are comparable to COBOL COMP-3.

Packed field values are rounded to the number of digits specified in the field format before they are stored.

When the number of decimal places input is greater than the number that can be stored, P field values are rounded first, then stored or displayed.

Packed fields are precisely accurate when sufficient decimal places are available to store values. Otherwise, since values are rounded before being stored, accuracy cannot be improved by increasing the number of digits displayed. For example, if 123.78 is input to a

packed field with 1 decimal place, 123.8 is stored. If the field's format is then changed to P6.2 using a COMPUTE or DEFINE, 123.80 will be displayed. If the field's format is changed to P6.2 in the Master File, 12.38 is displayed.

Storing and Displaying Values

For floating-point fields (format F or D), the stored values of decimal numbers are in hexadecimal and may convert to a value very slightly less than the actual decimal number. When the final digit is 5, these numbers may round down instead of up.

The following example shows an input value with two decimal places, which is stored as a packed field with two decimal places, a packed field with one decimal place, and a D field with one decimal place:

Master File

```
FILE=FIVE, SUFFIX=FOC
  SEGNAME=ONLY, SEGTYPE=S1,$
  FIELD=PACK2,,P5.2,$
  FIELD=PACK1,,P5.1,$
  FIELD=DOUBLE1,,D5.1,$
```

Program to Load Data

This MODIFY creates a file with three fields: a P field with two decimal places, a P field with one decimal place, and a D field with one decimal place. The same data values are then loaded into each field.

```
CREATE FILE FIVE
MODIFY FILE FIVE
FIXFORM  PACK2/5 PACK1/5 DOUBLE1/5
MATCH PACK2
  ON MATCH REJECT
  ON NOMATCH INCLUDE
DATA
1.05 1.05 1.05
1.15 1.15 1.15
1.25 1.25 1.25
1.35 1.35 1.35
1.45 1.45 1.45
1.55 1.55 1.55
1.65 1.65 1.65
1.75 1.75 1.75
```

```

1.85 1.85 1.85
1.95 1.95 1.95
END

```

TABLE Request

This TABLE request prints the values and a total for all three fields.

```

TABLE FILE FIVE
PRINT PACK2 PACK1 DOUBLE1
ON TABLE SUMMARIZE
END

```

The following report results:

```

PAGE          1

PACK2  PACK1  DOUBLE1
-----  -----  -----
 1.05   1.1    1.0
 1.15   1.2    1.1
 1.25   1.3    1.3
 1.35   1.4    1.3
 1.45   1.5    1.4
 1.55   1.6    1.5
 1.65   1.7    1.6
 1.75   1.8    1.8
 1.85   1.9    1.8
 1.95   2.0    1.9

TOTAL
15.00  15.5    15.0

```

The PACK2 values are not rounded. They are stored and displayed as they were entered. For example, 1.15 is stored internally as:

00	00	00	00	00	00	11	5C
----	----	----	----	----	----	----	----

The PACK1 values are rounded when stored and also when displayed. For example, the incoming value 1.15 is rounded to 1.2, and stored internally as:

00	00	00	00	00	00	01	2C
----	----	----	----	----	----	----	----

All of the DOUBLE1 values, except 1.25 and 1.75, are stored as repeating decimals in hex. For example, 1.15 is stored internally as:

41	12	66	66	66	66	66	66
----	----	----	----	----	----	----	----

The 41 in the first byte is equivalent to 64 in hex plus the exponent. The last seven bytes are the mantissa as converted to hex by the mainframe.

The DOUBLE1 values 1.25 and 1.75 are not repeating decimals internally. They are terminating decimals in hex, so they round up, when displayed, to 1.3 and 1.8 respectively. For example, 1.25 is stored internally as:

41	14	00	00	00	00	00	00
----	----	----	----	----	----	----	----

Since the PACK1 values are rounded up before they are stored, the PACK1 total is 0.5 higher than the PACK2 total. The D field total is the same as the PACK2 total because the D field values are stored as input, and then rounded for display.

Rounding in Calculations and Conversions

All computations are done in floating-point or decimal arithmetic, as defined by the FLOATMAPPING parameter. Packed fields are converted to D, M, or X internally, then back to P.

SET FLOATMAPPING enables you to take advantage of decimal-based precision numbers available in DB2 and Oracle, and extends that functionality to all numeric processing for floating point numbers. With this processing, you gain both precision, including improved rounding, and enhanced performance. The syntax is:

```
SET FLOATMAPPING = {D|M|X}
```

where:

D

Uses the standard double-precision processing. This is the default value.

M

Uses a new internal format that provides decimal precision for double-precision floating point numbers up to 16 digits.

X

Uses a new internal format that provides decimal precision for double-precision floating point numbers up to 34 digits.

Note: If the field is passed to a HOLD file, the internal data types X or M will be propagated to the USAGE and ACTUAL formats in the HOLD Master File.

When a field with decimal places is computed to an integer field, the decimal places are truncated, and the resulting value is the integer part of the input value.

When a field with decimal places is computed from one format to another, two conversions take place:

1. First, the field is converted internally to the data type specified by the FLOATMAPPING parameter.
2. Second, the result of this conversion is converted to the specified format. At this point, the rounding algorithm described previously is applied.

Redefining Field Formats

The following example illustrates some differences in the way packed fields, floating-point fields, and integer fields are stored and displayed. It also shows database values redefined to a format with a larger number of decimal places.

Master File

```
FILE=EXAMPLE, SUFFIX=FOC
SEGNAME=ONLY, SEGTYPE=S1,$
FIELD=PACKED2,,P9.2,$
FIELD=DOUBLE2,,D9.2,$
FIELD=FLOAT2,,F9.2,$
FIELD=INTEGER,,I9,$
FIELD=INTEGER,,I9,$
```

```
FIELD=MATH2,,M9.2,$
FIELD=XMATH2,,X9.2,$
```

Program to Load Data

This MODIFY creates a file with four fields: a P field with two decimal places, a D field with two decimal places, an F field with two decimal places, and an integer field. The same data values are then loaded into each field.

```
CREATE FILE EXAMPLE
MODIFY FILE EXAMPLE
FIXFORM PACKED2/9 X1 DOUBLE2/9 X1 FLOAT2/9 X1 INTEGER/9 X1
FIXFORM MATH2/9 X1 XMATH2/9
MATCH PACKED
  ON MATCH REJECT
  ON NOMATCH INCLUDE
DATA
1.6666666 1.6666666 1.6666666 1.6666666 1.6666666 1.6666666
125.16666 125.16666 125.16666 125.16666 125.16666 125.16666
5432.6666 5432.6666 5432.6666 5432.6666 5432.6666 5432.6666
4.1666666 4.1666666 4.1666666 4.1666666 4.1666666 4.1666666
5.5      5.5      5.5      5.5      5.5      5.5
106.66666 106.66666 106.66666 106.66666 106.66666 106.66666
7.2222222 7.2222222 7.2222222 7.2222222 7.2222222 7.2222222
END
```

Report Request

A DEFINE command creates temporary fields that are equal to PACKED2, DOUBLE2, and FLOAT2, with redefined formats containing four decimal places instead of two. These DEFINE fields illustrate the differences in the way packed fields and floating-point fields are stored and displayed.

The request prints the values and a total for all four database fields, and for the three DEFINE fields.

```
DEFINE FILE EXAMPLE
PACKED4/P9.4=PACKED2;
DOUBLE4/D9.4=DOUBLE2;
FLOAT4/D9.4=FLOAT2;
MATH4/M9.4=MATH2;
XMATH4/X9.4=XMATH2;
END
```

```

TABLE FILE EXAMPLE
PRINT PACKED2 PACKED4 DOUBLE2 DOUBLE4 FLOAT2 FLOAT4
MATH2 MATH4 XMATH2 XMATH4 INTEGER
ON TABLE SUMMARIZE
ON TABLE SET PAGE NOLEAD
ON TABLE HOLD FORMAT HTML
ON TABLE SET STYLE *
GRID=OFF,$
ENDSTYLE
END

```

The resulting report follows:

<u>PACKED2</u>	<u>PACKED4</u>	<u>DOUBLE2</u>	<u>DOUBLE4</u>	<u>FLOAT2</u>	<u>FLOAT4</u>	<u>MATH2</u>	<u>MATH4</u>	<u>XMATH2</u>	<u>XMATH4</u>	<u>INTEGER</u>
1.67	1.6700	1.67	1.6667	1.67	1.6667	1.67	1.6667	1.67	1.6667	2
125.17	125.1700	125.17	125.1667	125.17	125.1667	125.17	125.1667	125.17	125.1667	125
5432.67	5432.6700	5,432.67	5,432.6666	5432.67	5,432.6680	5,432.67	5,432.6666	5,432.67	5,432.6666	5433
4.17	4.1700	4.17	4.1667	4.17	4.1667	4.17	4.1667	4.17	4.1667	4
5.50	5.5000	5.50	5.5000	5.50	5.5000	5.50	5.5000	5.50	5.5000	6
106.67	106.6700	106.67	106.6667	106.67	106.6667	106.67	106.6667	106.67	106.6667	107
7.22	7.2200	7.22	7.2222	7.22	7.2222	7.22	7.2222	7.22	7.2222	7
TOTAL										
5683.07	5683.0700	5,683.06	5,683.0555	5683.05	5,683.0568	5,683.06	5,683.0555	5,683.06	5,683.0555	5684

PAGE 1

<u>PACKED2</u>	<u>PACKED4</u>	<u>DOUBLE2</u>	<u>DOUBLE4</u>	<u>FLOAT2</u>	<u>FLOAT4</u>	<u>INTEGER</u>
-----	-----	-----	-----	-----	-----	-----
1.67	1.6700	1.67	1.6667	1.67	1.6667	2
125.17	125.1700	125.17	125.1667	125.17	125.1667	125
5432.67	5432.6700	5,432.67	5,432.6666	5432.66	5,432.6641	5433
4.17	4.1700	4.17	4.1667	4.17	4.1667	4
5.50	5.5000	5.50	5.5000	5.50	5.5000	6
106.67	106.6700	106.67	106.6667	106.67	106.6667	107
7.22	7.2200	7.22	7.2222	7.22	7.2222	7
TOTAL						
5683.07	5683.0700	5,683.06	5,683.0555	5683.04	5,683.0529	5684

In this example, the PACKED2 sum is an accurate sum of the displayed values, which are the same as the stored values. The PACKED4 values and total are the same as the PACKED2 values.

The DOUBLE2 sum looks off by .01. it is not the sum of the printed values but a rounded sum of the stored values. The DOUBLE4 values show that the DOUBLE2 values are actually

rounded from the stored values. The DOUBLE4 values and sum show more of the decimal places from which the DOUBLE2 values are rounded.

The FLOAT2 total seems off by .02. Like the DOUBLE2 total, the FLOAT2 total is a rounded total of the stored FLOAT2 values. F fields are not accurate beyond eight digits, as the FLOAT4 column shows.

The XMATH2 and MATH2 sums look off by .01. They are not the sum of the printed values but a rounded sum of the stored values. The XMATH4 and MATH4 values show that the XMATH2 and MATH2 values are actually rounded from the stored values. The XMATH and MATH values and sum show more of the decimal places from which the XMATH2 and MATH2 values are rounded.

The integer sum is an accurate total. Like packed fields, the storage values and displayed values are the same.

DEFINE and COMPUTE

DEFINE and COMPUTE may give different results for rounded fields. DEFINE fields are treated like data source fields, while COMPUTE fields are calculated on the results of the display command in the TABLE request. The following example illustrates this difference:

```
DEFINE FILE EXAMPLE
DEFP3/P9.3=PACKED2/4;
END
```

```
TABLE FILE EXAMPLE
PRINT PACKED2 DEFP3
COMPUTE COMPP3/P9.3=PACKED2/4;
ON TABLE SUMMARIZE
END
```

The following report results:

PACKED2	DEFP3	COMPP3
-----	-----	-----
1.67	.417	.417
125.17	31.293	31.293
5432.67	1358.168	1358.168
4.17	1.042	1.042

5.50	1.375	1.375
106.67	26.668	26.668
7.22	1.805	1.805
TOTAL		
5683.07	1420.768	1420.767

The DEFP3 field is the result of a DEFINE. The values are treated like data source field values. The printed total, 1420.765, is the sum of the printed DEFP3 values, just as the PACKED2 total is the sum of the printed PACKED2 values.

The COMPP3 field is the result of a COMPUTE. The printed total, 1420.767, is calculated from the total sum of PACKED2 (5683.07 / 4).

File Description Attribute Summary

This appendix lists the attributes supported for Master Files and Access Files for FOCUS and XFOCUS data sources.

Overview of File Descriptions

The description of a FOCUS file is a series of comma-separated attributes which are stored in a file which is identified as a Master File.

A Master File can refer to an Access File. The Access File provides comprehensive metadata management for FOCUS data sources. It shields end users from the complex file storage and configuration details used for access to partitioned and distributed data sources.

The Access File is a series of blank-separated attributes that describe how to locate, concatenate, join, and select the appropriate physical data files for retrieval requests against one or more FOCUS data sources.

Access Files are optional, except for retrieval requests using intelligent partitioning. One Access File can contain information for one or more Master Files.

A Business View (BV) of a Master File groups related items together to reflect an application's business logic rather than the physical position of items in the data source.

Master File Attributes

The following sections list the attributes supported in a Master File.

Master File FILE Attributes

ACCESS

Identifies the Access File for a FOCUS data source.

DATASET

Identifies the fully-qualified physical file name.

FILENAME

Identifies the Master File.

REMARKS|DESC[RIPTION]

Provides descriptive text in the default language.

DESC_In

Provides descriptive text in a language identified by the language code *ln*.

SUFFIX

Identifies the type of data source.

Master File Segment Attributes

DATASET

Identifies the fully-qualified physical file name of a LOCATION or cross-referenced segment in a FOCUS data source.

ENCRYPT

Causes the data values for a segment to be encoded as they are added to the database.

LOCATION

Names a separate file where a segment of data or a text field is located.

OCCURS

Identifies repeating fields.

PARENT

Identifies a segment's parent segment.

POSITION

Names a field in the parent segment that acts as a place holder for repeating fields in the middle of a record.

SEGNAME

Assigns a segment name.

SEGTYPE

Declares the sort order and number of key fields in a segment.

Master File Field Attributes

ACCEPT

Assigns a list or range of acceptable data values to a field, or identifies a file in which acceptable values are stored. The values are used to test transaction values during data maintenance operations. For files with multiple record types described by a generalized record structure, ACCEPT assigns valid RECTYPE data values.

ACTUAL

Declares the type and length of a field in a non-FOCUS data source.

ALIAS

Assigns an alternate field name. For relational databases, ALIAS is set to the field's column name. For non-FOCUS data source containing multiple record types, ALIAS is set to the value of the record type flag.

COMPUTE

Stores a temporary field definition in the Master File for use as a COMPUTE in a request.

DATEPATTERN

Provides a pattern for converting non-standard alphanumeric dates to FOCUS dates.

DEFINE

Creates a virtual field.

DESC

Provides descriptive text in the default language.

DESC_In

Provides descriptive text in a language identified by the language code *ln*.

FIELDNAME

Assigns a field name.

FIELDTYPE

Identifies an indexed field.

FILTER

Defines a named boolean expression to use in WHERE or IF tests in a request.

FORMAT

Declares the type, length, and display options of a field in a FOCUS database. For other data files, declares how FOCUS is to display and use the data values.

GROUP

Describes multiple fields as a single entity.

ELEMENTS

Identifies group fields as a set of elements. Eliminates the need to specify USAGE and ACTUAL formats for the group field.

HELPMESSAGE

Assigns a one-line text message that can be displayed at the bottom of a CRTFORM screen.

INDEX

Same as FIELDTYPE.

LOCATION

Names a separate file where a segment of data or a text field is located.

MAPFIELD

Is a field in the fixed portion of a segment that contains the record type for a descendant OCCURS segment with record types.

MAPVALUE

Associates each OCCURS segment with its associated MAPFIELD record indicator.

MISSING

Causes FOCUS to distinguish null values from intentionally entered zeros or blanks.

ORDER

Declares an internal counter for an OCCURS segment that associates a sequence number with each repetition.

RECTYPE

Identifies the type of record in a non-FOCUS data source with multiple record types.

TITLE

Provides a column heading in the default language.

TITLE_In

Provides a column heading in a language identified by the language code *ln*.

USAGE

Same as FORMAT.

Master File Attributes That Join Data Sources

CRFILE

Names the cross-referenced file in a Master-defined join.

CRKEY

Names the common field in a Master-defined join.

CRSEGNAME

Names the cross-referenced segment that contains the common field in a Master-defined join.

Master File Data Security Attributes

ACCESS

Specifies a user's access rights.

DBA

Establishes the administrator's password.

DBAFILE

Names a central file that contains security information.

END

Marks the end of the Master File.

NAME

Identifies the restricted segment or field.

RESTRICT

Controls Access to segments and fields

USER

Establishes a user's password.

VALUE

Defines the test condition.

Master File Hierarchy Attributes

PROPERTY

Identifies a field as a parent of the hierarchy field (PROPERTY=PARENT_OF) or a caption for the hierarchy field (PROPERTY=CAPTION).

REFERENCE

Identifies the hierarchy field.

Access File Attributes

An Access File for a FOCUS data source can contain information for multiple Master Files.

General Access File Attributes

MASTER

Identifies a Master File.

DATA

Is the fully-qualified physical file name of a partition.

WHERE test1 ;

Supplies a condition that identifies which records are stored in the associated partition.

LOCATION

Identifies a segment stored in a separate physical file. Has an associated DATA attribute to supply the physical file name.

MDI Access File Attributes

MDI

Identifies the name of the MDI.

TARGET_OF

Identifies the segment that contains the measures to which the MDI points. If the measures are in multiple segments, identifies the top segment that contains the measures.

DIM

Identifies a field that is a dimension. A minimum of two dimensions are required.

MAXVALUES

Is the number of distinct values the dimension field can have.

WITHIN

Defines a hierarchy of dimensions by naming a child dimension within a parent dimension.

MDIDATA

Identifies the physical name of the MDI file. Multiple MDIDATAs describe concatenated partitions.

Related Commands

The following commands apply to describing data.

CHECK

Tests a Master File for common errors, diagrams the segments and relationships, and holds information from the Master File as a data file that you can query with the reporting language.

CREATE

Creates a new FOCUS or relational data source or erases data in an existing data source.

DECRYPT

Decodes an encoded Master File or FOCEXEC.

DEFINE

Creates temporary fields from expressions that use constants, mathematical and logical operators, and other real or temporary fields.

ENCRYPT

Encodes a Master File or FOCEXEC.

JOIN

Joins two data sources using one or more fields with common data or a test condition.

NODISP

Is a CRTFORM field attribute that you can use to suppress password display.

RESTRICT

Applies a new or changed DBA password to a data file.

SET MAXLRECL

Enables FOCUS to manage extra-long records.

SET USER

Sets a password for the FOCUS session.

SET PASS

Sets a user password.

USE

Specifies the name and/or location of FOCUS data sources.

ibi Documentation and Support Services

For information about this product, you can read the documentation, contact Support, and join Community.

How to Access ibi Documentation

Documentation for ibi products is available on the [Product Documentation website](#), mainly in HTML and PDF formats.

The [Product Documentation website](#) is updated frequently and is more current than any other documentation included with the product.

Product-Specific Documentation

The documentation for this product is available on the [ibi™ FOCUS® Documentation](#) page.

How to Contact Support for ibi Products

You can contact the Support team in the following ways:

- To access the Support Knowledge Base and getting personalized content about products you are interested in, visit our [product Support website](#).
- To create a Support case, you must have a valid maintenance or support contract with a Cloud Software Group entity. You also need a username and password to log in to the [product Support website](#). If you do not have a username, you can request one by clicking **Register** on the website.

How to Join ibi Community

ibi Community is the official channel for ibi customers, partners, and employee subject matter experts to share and access their collective experience. ibi Community offers access to Q&A forums, product wikis, and best practices. It also offers access to extensions, adapters, solution accelerators, and tools that extend and enable customers to gain full value from ibi products. For a free registration, go to [ibi Community](#).

Legal and Third-Party Notices

SOME CLOUD SOFTWARE GROUP, INC. (“CLOUD SG”) SOFTWARE AND CLOUD SERVICES EMBED, BUNDLE, OR OTHERWISE INCLUDE OTHER SOFTWARE, INCLUDING OTHER CLOUD SG SOFTWARE (COLLECTIVELY, “INCLUDED SOFTWARE”). USE OF INCLUDED SOFTWARE IS SOLELY TO ENABLE THE FUNCTIONALITY (OR PROVIDE LIMITED ADD-ON FUNCTIONALITY) OF THE LICENSED CLOUD SG SOFTWARE AND/OR CLOUD SERVICES. THE INCLUDED SOFTWARE IS NOT LICENSED TO BE USED OR ACCESSED BY ANY OTHER CLOUD SG SOFTWARE AND/OR CLOUD SERVICES OR FOR ANY OTHER PURPOSE.

USE OF CLOUD SG SOFTWARE AND CLOUD SERVICES IS SUBJECT TO THE TERMS AND CONDITIONS OF AN AGREEMENT FOUND IN EITHER A SEPARATELY EXECUTED AGREEMENT, OR, IF THERE IS NO SUCH SEPARATE AGREEMENT, THE CLICKWRAP END USER AGREEMENT WHICH IS DISPLAYED WHEN ACCESSING, DOWNLOADING, OR INSTALLING THE SOFTWARE OR CLOUD SERVICES (AND WHICH IS DUPLICATED IN THE LICENSE FILE) OR IF THERE IS NO SUCH LICENSE AGREEMENT OR CLICKWRAP END USER AGREEMENT, THE LICENSE(S) LOCATED IN THE “LICENSE” FILE(S) OF THE SOFTWARE. USE OF THIS DOCUMENT IS SUBJECT TO THOSE SAME TERMS AND CONDITIONS, AND YOUR USE HEREOF SHALL CONSTITUTE ACCEPTANCE OF AND AN AGREEMENT TO BE BOUND BY THE SAME.

This document is subject to U.S. and international copyright laws and treaties. No part of this document may be reproduced in any form without the written authorization of Cloud Software Group, Inc.

ibi, the ibi logo, FOCUS, iWay, WebFOCUS, RStat, Information Builders, Studio, and TIBCO are either registered trademarks or trademarks of Cloud Software Group, Inc. in the United States and/or other countries.

All other product and company names and marks mentioned in this document are the property of their respective owners and are mentioned for identification purposes only. You acknowledge that all rights to these third party marks are the exclusive property of their respective owners. Please refer to Cloud SG’s Third Party Trademark Notices (<https://www.cloud.com/legal>) for more information.

This document includes fonts that are licensed under the SIL Open Font License, Version 1.1, which is available at: <https://scripts.sil.org/OFL>

Copyright (c) Paul D. Hunt, with Reserved Font Name Source Sans Pro and Source Code Pro.

Cloud SG software may be available on multiple operating systems. However, not all operating system platforms for a specific software version are released at the same time. See the “readme” file for the availability of a specific version of Cloud SG software on a specific operating system platform.

THIS DOCUMENT IS PROVIDED “AS IS” WITHOUT WARRANTY OF ANY KIND, EITHER EXPRESS OR IMPLIED, INCLUDING, BUT NOT LIMITED TO, THE IMPLIED WARRANTIES OF MERCHANTABILITY, FITNESS FOR A PARTICULAR PURPOSE, OR NON-INFRINGEMENT.

THIS DOCUMENT COULD INCLUDE TECHNICAL INACCURACIES OR TYPOGRAPHICAL ERRORS. CHANGES ARE PERIODICALLY ADDED TO THE INFORMATION HEREIN; THESE CHANGES WILL BE INCORPORATED IN NEW EDITIONS OF THIS DOCUMENT. CLOUD SG MAY MAKE IMPROVEMENTS AND/OR CHANGES IN THE PRODUCT(S), THE PROGRAM(S), AND/OR THE SERVICES DESCRIBED IN THIS DOCUMENT AT ANY TIME WITHOUT NOTICE.

THE CONTENTS OF THIS DOCUMENT MAY BE MODIFIED AND/OR QUALIFIED, DIRECTLY OR INDIRECTLY, BY OTHER DOCUMENTATION WHICH ACCOMPANIES THIS SOFTWARE, INCLUDING BUT NOT LIMITED TO ANY RELEASE NOTES AND "README" FILES.

This and other products of Cloud SG may be covered by registered patents. For details, please refer to the Virtual Patent Marking document located at <https://www.cloud.com/legal>.

Copyright © 2021-2025. Cloud Software Group, Inc. All Rights Reserved.